

1. REPORT NUMBER  CA16-2987	2. GOVERNMENT ASSOCIATION NUMBER	3. RECIPIENT'S CATALOG NUMBER
4. TITLE AND SUBTITLE FREIGHT EFFICIENCY STRATEGIES: A White Paper Series to Inform the California Sustainable Freight Action Plan	5. REPORT DATE  03/01/2016	
	6. PERFORMING ORGANIZATION CODE	
7. AUTHOR  Genevieve Giuliano, USC and Tom O'Brien, CSU, Long Beach	8. PERFORMING ORGANIZATION REPORT NO.	
9. PERFORMING ORGANIZATION NAME AND ADDRESS Institute of Transportation Studies, National Center for Sustainable Transportation University of California, Davis West Village, 1605 Tilia, Suite #100, Davis, CA 95616	10. WORK UNIT NUMBER	
	11. CONTRACT OR GRANT NUMBER  65A0527 TO 021	
12. SPONSORING AGENCY AND ADDRESS National Center for Sustainable Transportation University of California, Davis West Village, 1605 Tilia, Suite #100, Davis, CA 95616	13. TYPE OF REPORT AND PERIOD COVERED Final Report, October 1, 2015 through May 1, 2016	
	14. SPONSORING AGENCY CODE  Caltrans, DRISI	
15. SUPPLEMENTARY NOTES The objective of this research was to identify a set of potential strategies that could improve California's freight system performance and efficiency. The white papers focused on those strategies aimed at maximizing asset utilization by fostering collaborative logistics (CL) practices and/or freight demand management (FDM).		
16. ABSTRACT A number of stakeholders met with the ultimate goal of identifying inefficiencies faced by the freight system and putting forward a set of strategies to achieve a more efficient freight system. In doing so, a key first step was to provide insight as to the possible root cause(s) of major inefficiencies affecting the system. In addition to assessing inefficiencies, this research describes some of the aspects and necessary conditions that need to be considered when defining or identifying remediating strategies. Moreover, the research discusses a number of efficiency improvement strategies. These include: <ul style="list-style-type: none"> <li>• Voluntary Off-Hour Delivery Programs.</li> <li>• Receiver-led Consolidation.</li> <li>• Development of a Chassis Pool of Pools Fully Integrated System.</li> <li>• Improvement of Traffic Mitigation Fee Programs.</li> <li>• Implement Advanced Appointment/ Reservation Systems.</li> <li>• Developing an Integrated System for Dray Operations and Services.</li> <li>• Load Matching and Maximizing Capacity.</li> </ul> In light of the Governor's Executive Order, it is imperative that the various public agencies in the State initiate, continue or reinforce efforts to address some of these issues.		
17. KEY WORDS National Center for Sustainable Transportation, NCST, UC Davis, Sustainability, Freight Efficiency Strategy Development Group (FESDG), Air Resources Board (ARB), Caltrans, California Energy Commission (CEC), freight, California Freight System, Freight Demand Management (FDM), asset utilization	18. DISTRIBUTION STATEMENT The readers can freely refer to and distribute this report. If there are nay questions, please contact one of the authors.	
19. SECURITY CLASSIFICATION <i>(of this report)</i>  No security issues	20. NUMBER OF PAGES  232	21. COST OF REPORT CHARGED  Free for E-copy

## **About the Freight Efficiency Strategies Development Group**

In July 2015, Governor Jerry Brown issued Executive Order B-32-15, directing several state agencies to work together in developing an integrated action plan that will “establish clear targets to improve freight efficiency, transition to zero-emission technologies, and increase competitiveness of California’s freight system” and that the plan should “identify state policies, programs, and investments to achieve these targets”. In response, an interagency group was formed to oversee the development of the California Sustainable Freight Action Plan (CSFAP). Members of the interagency group include the California Air Resources Board, the California Department of Transportation (Caltrans), the California Energy Commission (CEC), and the Governor's Office of Business and Economic Development (GO-Biz). As part of developing the plan, the interagency group has solicited feedback from a broad range of stakeholders through a variety of engagement activities and outreach efforts. A component of this engagement was the development of the Freight Efficiency Strategies Development Group (FESDG) made up of freight experts from academia, industry, and government. The purpose and main task of this group was to produce a series of white papers that identify promising strategies for increasing the efficiency of the freight system. A series of six papers were developed over the course of six months. Each paper focuses on a specific theme for increasing freight efficiency within the larger freight system.

## **Disclaimer**

The content of the white papers produced by the group represents discussions among many individuals representing various freight industry stakeholders. It may not reflect consensus on the part of all of the participants, nor do these papers necessarily represent the official opinion or policy of the represented organizations, but rather a range of thinking that might be used to inform and build consensus for the development of the California Sustainable Freight Action Plan. Given the perspective of the various freight stakeholders, paper authors have attempted to include dissenting opinions and areas of concurrence where they may exist. The U.S. Government and the State of California assumes no liability for the contents or use thereof. Nor does the content necessarily reflect the official views or policies of the U.S. Government and the State of California. This report does not constitute a standard, specification, or regulation.

# **FREIGHT EFFICIENCY STRATEGIES**

March 2016

A White Paper Series to Inform the California  
Sustainable Freight Action Plan

# Freight Efficiency Strategies White Paper Series

## Introduction

In July 2015, Governor Jerry Brown issued Executive Order B-32-15, directing several state agencies to work together in developing an integrated action plan that will “establish clear targets to improve freight efficiency, transition to zero-emission technologies, and increase competitiveness of California’s freight system” and that the plan should “identify state policies, programs, and investments to achieve these targets”. In response, an interagency group was formed to oversee the development of the California Sustainable Freight Action Plan (CSFAP). Members of the interagency group include the California Air Resources Board, the California Department of Transportation (Caltrans), the California Energy Commission (CEC), and the Governor's Office of Business and Economic Development (GO-Biz) as well as the California State Transportation Agency (CalSTA), the California Environmental Protection Agency (CalEPA), and the Natural Resources Agency (CNRA).

As part of developing the plan, the interagency group has solicited feedback from a broad range of stakeholders through a variety of engagement activities and outreach efforts. A component of this engagement was the development of the Freight Efficiency Strategies Development Group (FESDG) made up of freight experts from academia, industry, and government. The purpose and main task of this group was to produce a series of white papers that identify promising strategies for increasing the efficiency of the freight system. A series of six papers were developed over the course of six months. Each paper focuses on a specific theme for increasing freight efficiency within the larger freight system.

The content of the white papers produced by the group represents discussions among many individuals representing various freight industry stakeholders. It may not reflect consensus on the part of all of the participants, nor do these papers necessarily represent the official opinion or policy of the represented organizations, but rather a range of thinking that might be used to inform and build consensus for the development of the California Sustainable Freight Action Plan. Given the perspective of the various freight stakeholders, paper authors have attempted to include dissenting opinions and areas of concurrence where they may exist.

Abstracts for each paper is included below.

### **Topic #1: Funding for Freight Infrastructure and Clean Equipment**

**Lead Authors:** Will Kempton and Garth Hopkins, California Transportation Commission

The white paper provides an overview of the need for additional funding for both continued development of California’s freight infrastructure and expansion of clean equipment for freight. The paper advocates for the continuation of the successful Trade Corridors Improvement Fund (TCIF) and the Goods Movement Emission Reduction Program (GMERP). As additional funding for freight improvements is identified, both TCIF and GMERP should be continued under a new program titled “TCIF/GMERP-Phase II”. The white paper also lists suggested selection criteria and possible improvements for a TCIF/GMERP-Phase II program.

## **Topic #2: Strategies to Maximize Asset Utilization in the California Freight System: Part I – Background and General Recommendations**

**Lead Author:** Miguel Jaller, University of California, Davis

This paper (Part I of a two-part series) provides a brief overview of the freight system, with an emphasis on key stakeholders, their roles and interactions, and implications associated with the types of freight movements and layers of the economy. Moreover, the work discusses major inefficiencies in the on-road trucking and maritime sectors, where congestion often impedes maximizing asset utilization. The paper presents a number of general recommendations to improve freight efficiency; while specific strategies are discussed in the second part of this series. General recommendations include: conducting sound freight planning at all levels with emphasis on urban freight; identifying behaviors that need to be fostered, or mitigated, among the various stakeholders; developing participatory stakeholder engagement; fostering information sharing; developing plans, agreements and platforms for active conversation to address labor issues; investing in workforce development; and investing in research and continued improvement efforts. In addition, this paper acknowledges the fact that it is not likely that any single strategy will result in significant-enough improvements on its own. The inherently complex nature of the system will require an equally complex set of solutions.

## **Strategies to Maximize Asset Utilization in the California Freight System: Part II – Strategies**

**Lead Author** – Miguel Jaller, University of California, Davis

The freight system is multi-faceted and there could be a myriad of potential strategies; however, the paper (Part II of a two-part series) focuses on those that could improve or help maximize asset utilization by fostering collaborative logistics (CL) practices and/or freight demand management (FDM). The strategies analyzed include: receiver-led consolidation; voluntary off-hour delivery programs; development of an integrated Chassis Pool of Pools; integrated system for dray services; load matching and maximizing capacity; improving Traffic Mitigation Fee programs; implementing advanced appointment and reservation systems; and relaxing vehicle size and weight restrictions. The paper discusses each strategy in terms of its nature (CL or FDM); the geographic scope of the inefficiency or implementation; the expected benefits; level of implementation effort/time/cost; the primary stakeholders targeted; the stakeholders' role in the implementation/planning effort; the potential for unintended consequences; and barriers for implementation. The research shows that there is great variability in the level of data available (e.g., research reports, operational reports, implementation programs, pilot tests) to conduct detailed assessments, highlighting the need for additional efforts to be able to estimate the magnitude of the potential effects of each strategy to reduce inefficiencies (e.g., congestion/delays, environmental emissions, safety, and economic impacts, and costs, among others). However, stakeholder engagement during the research process allowed for a qualitative assessment based on empirical evidence from on-going efforts.

#### **Topic # 4: Planning and Policy**

**Lead Authors:** Tom O’Brien, California State University, Long Beach

Increasing trade volumes at freight hubs and nodes, including maritime ports, airports, intermodal facilities, and border crossings, provide significant economic benefit but also social costs. Increased volume of trade creates jobs, generates State and local tax revenue, and creates positive externalities. High trade volumes also impose costs, including vehicle congestion, collisions, environmental costs, and increased infrastructure development and maintenance and preservation costs. This white paper explores the ways that state departments of transportation can enhance their policy and planning efforts—and the outreach efforts that inform those processes—to better implement infrastructure, operational, and technology based modernization strategies to improve system productivity and efficiency.

#### **Topic # 5: Operational Modernization at Distribution Nodes**

**Lead Authors:** Tom O’Brien, California State University, Long Beach

This white paper identifies a range of technological and process-driven opportunities that hold the potential for modernizing distribution nodes to promote freight efficiency while also improving safety and air quality standards. To promote improved truck access at distribution nodes, the research investigated the use of truck platooning, virtual container yards, design-based guidelines, and weigh-in-motion strategies to improve freight efficiency. The research also explores strategies focused on establishing energy independence at marine terminals through the use of energy microgrids.

#### **Topic # 6: Information Technology**

**Lead Author:** Genevieve Giuliano, University of Southern California

This white paper explores the potential to improve data and information systems, both public and private, to increase system efficiency. It presents recommendations for using information technology solutions to increase the efficiency of California’s multimodal freight system. These recommendations resulted from a consensus based process by working group committee members. We address two problems: information problems in the goods movement supply chain, and information problems in statewide trucking. Regarding the goods movement supply chain, we recommend the following strategies: 1) accelerate and expand the FRATIS program; 2) implement ports-wide appointment systems at the state’s major ports; 3) develop and implement a transparent supply chain wide load tracking system. Regarding statewide trucking, we recommend the following strategies: 4) statewide smart parking system; 5) “push” freight information system; 6) statewide freight information platform; 7) border region ITS strategy; and 8) freight focused traffic management.

The full white papers can be downloaded on the California Sustainable Freight Action Plan website, found here: <http://www.casustainablefreight.org/>

The table below summarizes recommended strategies from each of the white papers.

## WHITE PAPER RECOMMENDED STRATEGIES TABLE

WHITE PAPER TITLE	THEMES	STRATEGIES
<p>Funding for Freight Infrastructure and Clean Equipment</p> <p>Lead Authors: Will Kempton and Garth Hopkins California Transportation Commission</p>		I. All Federal and State freight funding administered by the State should continue using the successful TCIF model”.
		II. Ensure TCIF/GMERP-Phase II Funds are Leveraged With Other Funding Sources
		III. Develop a Long-Term Funding Program Specifically for Freight Infrastructure and Clean Equipment
		V. Minimize the Complexity of State Administered Freight Funding Programs
		VI. Improve Existing Access Infrastructure to California’s Major Port Facilities
		VII. Underwrite Present Capital Expenses In Anticipation of Future Benefits
<p>Maximizing Asset Utilization: General Recommendations</p> <p>Lead Author: Miguel Jaller University of California, Davis</p>	<p><b>A. Cargo and Vehicle Movements</b></p>	
	<p><b>B. Inefficiencies in the Freight System</b></p>	III. Conduct sound freight planning at all levels with emphasis on urban freight and strategic freight corridors
	<p><b>C. Key Stakeholders, their Roles and Interactions</b></p>	V. Participatory stakeholder engagement
		VI. Developing appropriate strategies requires insights and detailed analysis of how each supply chain operates.

		III. Freight Parking: Improve freight parking/loading/unloading area management and availability
	<b>B. International Gateways</b>	
Planning and Policy  Lead Author: Tom O'Brien – California State University, Long Beach	<b>A. Strategic Statewide and Interregional Freight Planning</b>	
	<b>B. Truck Routes and Integrated Corridor Management</b>	
		III. Assessing national best practices: Look to other states for examples of their experiences with



Operational Modernization at Distribution Nodes  Lead Author: Tom O'Brien California State University Long Beach	<b>A. Energy Efficiency at Marine Terminals</b>	I. Energy Efficiency at Marine Terminals: Use Smart Micro Grids to increase energy reliability at marine terminals and promote the use of alternative energy in the system. State may potentially need to regulate cost.
	<b>B. Improved Truck Access at Nodes</b>	II. Truck Platooning: Mitigate bottlenecks at ports through Truck Platooning to promote efficient use of roadways.
		III. Virtual Container Yards: Promote the use of virtual container yards to increase empty container interchange between importers and exporters; reduce the incidence of uncoordinated empty trips between import warehouses and ports.
<b>C. Design-based Guidelines</b>	III. Intermodal facilities: Implement design based guidelines in order to consolidate deliveries across vendors and encourage the prevalence of intermodal freight facilities.	
Information Technology  Lead Author: Genevieve Guiliano University of Southern California	<b>A. Information Problems in the Goods Movement Supply Chain</b>	I. Accelerate and Expand the FRATIS Program: Establish public private partnerships that would integrate and manage freight movement and other data and provide operation and maintenance support to facilitate the establishment of FRATIS at a larger scale.
		II. Implement a system-wide appointments system at California's major seaports: research the feasibility of an appointment system for truck gate entries and dock transactions that is universal across all port terminals in a given complex.
		III. Design a fully transparent tracking system across the supply chain: Research the effects of tracking systems on load matching; trip predictability, and drayage turn times.
	<b>B. Information Problems in Statewide Tracking</b>	IV. Develop and Implement a statewide parking system and increase the supply of truck parking: Implement an action plan to integrate and expand truck parking reservation systems in the state.
		V. Develop and implement a "push" freight traffic information system: research feasibility of corridor specific traffic alerts designed for truckers.
		VI. Develop and implement a statewide freight information platform: Integrate state and regional truck route data and present it in an accessible format.
		VII. Implement the Border Region ITS Strategy
		VIII. Freight Focused Traffic Management: Develop and Implement freight priority traffic management in high volume truck corridors

# FUNDING FOR FREIGHT INFRASTRUCTURE AND CLEAN EQUIPMENT

March 2016

A White Paper from the Freight Efficiency  
Strategies Development Group

**Lead Authors:**

**Will Kempton**, California Transportation Commission

**Garth Hopkins**, California Transportation Commission

**Working Group Members:** **Annie Nam**, Southern California Association of Governments; **Chris Shimoda**, California Trucking Association; **Cynthia Cory**, California Farm Bureau

**David Libatique**, Port of Los Angeles; **Fran Inman**, Majestic Realty;

**Kerry Cartwright**, Port of Los Angeles; **LaDonna DiCamillo**, BNSF

Railroad; **Mike Jacob**, Pacific Merchant Shipping Association; **Pat**

**Smith**, Harris Ranch; **Wes Lujan**, Union Pacific Railroad; and **Christina**

**Casgar**, San Diego Association of Governments

[page left intentionally blank]

# TABLE OF CONTENTS

EXECUTIVE SUMMARY .....	iii
Abstract.....	1
Background .....	1
Proposition 1B (2006) Overview .....	2
TCIF Overview as Part of Proposition 1B.....	3
Discussion .....	6
TCIF-Phase II Should Incorporate Many of the Criteria Identified in New Federal Transportation Act .....	6
Current State Proposals Regarding Freight Funding .....	7
TCIF/GMERP-Phase II .....	8
Recommendations .....	9

# Funding for Freight Infrastructure and Clean Equipment

## EXECUTIVE SUMMARY

The 2007 Goods Movement Action Plan prepared by the California Department of Transportation (Caltrans) in 2007 established a clear connection that freight infrastructure investments and freight emissions are often related issues. This was confirmed in the 2014 California Freight Mobility Plan and the on-going Sustainable Freight Strategy.

The passage of Proposition 1B or “Prop 1B” in 2006 provided \$20 billion in additional funding for California’s transportation infrastructure, of which \$3.1 billion was dedicated to the improvement of the State’s freight network including \$2 billion administered by the California Transportation Commission (CTC) specifically dedicated for the Trade Corridors Improvement Fund, or “TCIF”. In addition, the California Air Resources Board (ARB) administered a total of \$1 billion in Prop 1B funds used for the Goods Movement Emission Reduction Program (GMERP). The purpose of GMERP is to provide grant funds to local agencies (such as air districts and seaports) to quickly reduce air pollution emissions and health risk from freight movement along California's trade corridors. These funds were instrumental in ensuring California maintained competitive with other states.

The TCIF and GMERP were two separate programs, but not disassociated. The TCIF criteria was developed by the CTC with extensive participation and input from regional stakeholders; and the GMERP criteria was prepared by the ARB. The issue of infrastructure investment and air quality investment are strongly linked. How that linkage is assessed and financed, is a complex policy decision. This paper asserts the separate but associated funding approach as employed with Prop 1B through the TCIF/GMERP process is a good starting point for future funding programs.

The recent five-year \$305 billion federal transportation reauthorization known as “Fixing America's Surface Transportation Act”, or “FAST Act” allocated funding specifically for freight projects. A total of \$10.8 billion in funds has been specifically directed to improve the national freight infrastructure: \$6.3 billion in freight formula funds intended to target investments on a newly-designated “National Highway Freight Network” and; \$4.5 billion for a competitive grant program prioritizing “nationally significant freight and highway projects” for urban and rural areas. The U.S. Department of Transportation recently released the Notice of Funding Opportunity (NOFO) to expedite the award the first round of the competitive grants.

The funding available through TCIF was able to leverage an additional \$5.2 billion in public and private funds. The TCIF and GMERP programs are both models that should be replicated for future freight funding programs in California. The first opportunity to use the TCIF and GMERP models for “TCIF/GMERP-Phase II” will be with an approximate \$582 million in dedicated federal formula freight funding to be allocated to California over the next five years.

In January 2016, the Governor introduced his proposed budget for fiscal year 2016-17 which includes a total of \$211 million for trade corridor improvements. Senator Beall and Assembly Member Frazier have both introduced separate legislation that would provide funding for freight infrastructure improvements. With respect to the next generation of GMERP-like funding focused on reducing emissions, two other bills have been subsequently introduced related to freight funding: AB 1780 (Medina) would establish the Sustainable Trade Corridors Program using 25% of the annual Cap and Trade proceeds; and AB 1657 (O'Donnell) would establish the Zero and Near-Zero Emission Intermodal Terminals Program and the Port Building and Lighting Efficiency Greenhouse Gas Reduction Fund Program.

The Funding for Improving Existing Infrastructure subgroup recommends that the TCIF/GMERP model be used for allocation of future freight infrastructure funding, and that Cap and Trade proceeds continue to be used to fund demonstration projects that accelerate use of advanced technology that results in greenhouse gas and criteria emission reductions from freight. A TCIF/GMERP-Phase II program would take the positive aspects of the 2006 TCIF and GMERP programs and include project selection criteria, which will continue to mirror the triple bottom line goals to improve freight efficiency, transition to zero-emission technologies, and increase competitiveness of California's freight system as stated in the Governor's Executive Order B-32-15.

SB 1228 (Hueso, 2014) added language to the Streets and Highways Code which continues the existence of the TCIF program. Suggested performance measures/selection criteria for TCIF-Phase II are discussed on page 10 of this paper.

## Abstract

*“Identify infrastructure investments that will improve California’s freight system to increase efficiency, competitiveness and environmental sustainability. Estimate the economic, air emissions and efficiency benefits from such infrastructure investments and develop an evaluative framework for how to weigh these benefits as part of an integrated implementation strategy. Identify necessary private and public sector actions and policies, including funding and financing strategies that are conducive to various infrastructure investments and/or efficiency measures. These actions and policies should focus on achieving the objectives of the Governor’s Executive Orders and the desired outcomes of those Orders to support environmental, energy, mobility, safety and economic goals.”*

## Background

The Governor’s July 2015 Executive Order B-32-15 identified that California’s complex freight transportation system is responsible for one-third of the State’s economy and jobs, with freight-dependent industries accounting for over \$700 billion in revenue and over five million jobs in 2013.

Both public and private sectors have a long history of investment in California’s freight system to create the nation’s most diverse, highest capacity freight network that not only links the state to the national and global economies but also serves as the nation’s primary gateway to the Pacific Rim. Given that California has a population of over 38 million people, it should also be recognized that a considerable amount of freight traffic stays within the state’s borders.

However, the investment in California’s freight infrastructure has not kept pace with the necessary improvements to maintain economic competitiveness, address the state’s environmental goals, or quite simply to meet the increased capacity demands. This has been articulated by the California Department of Transportation (Caltrans) in the December 2014 *California Freight Mobility Plan (CFMP)*. Subsequent updates to the CFMP should continue to note California’s unique freight needs.

Congestion on California’s surface transportation system is an impediment to every Californian which includes the mobility of the trucks moving freight on both the highways and local roads. This congestion increases vehicle emissions and reduces our economic competitiveness. For example, the Southern California Association of Governments (SCAG) draft 2016 Regional Transportation Plan/Sustainable Community Strategy (RTP/SCS) stated that driver wages and fuel costs represent 50 percent of total motor carrier costs, and trucks idling on heavily congested roads increase their travel time which has a major impact on the bottom line of the trucking industry.

According to an April 2014 report prepared by the American Transportation Research Institute titled: *Cost of Congestion to the Trucking Industry*, the Los Angeles metropolitan area was identified as leading the nation in costs to the trucking industry caused by traffic congestion

with nearly \$1.1 billion in added operational costs to the industry. At the national level, the report also highlighted the following:

- In 2013, increased costs to the trucking industry due to congestion delays totaled \$9.2 billion. Total truck delay in 2013 was 141 million hours, equating to over 51,000 drivers sitting idle for a working year.
- Congestion was concentrated in urban areas with 89 percent of costs incurred on only 12 percent of the national Interstate Highway System.

Rail productivity is also challenged by capacity choke points along critical corridors and at intermodal terminals as freight demand grows. In Southern California, for example, train traffic is projected to more than double by 2040, requiring significant improvements to rail terminal capacity, including the construction of on-dock and near-dock intermodal terminals. When desired passenger train growth is taken into account, there will be needs for new rail line capacity as freight rail traffic often shares limited track capacity with passenger rail traffic. Additionally, grade crossings can be the source of significant delay to the traveling public and also pose a serious risk of collisions between trains and vehicles.

According to the San Diego Association of Government (SANDAG)-Caltrans study, *2007 Update: Economic Impacts of Border Wait Times in the San Diego-Baja California Border Region*, the border traffic congestion and delays cost the U.S. and Mexican economies an estimated \$7.2 billion in gross output (value of goods and services produced annually) and more than 62,000 jobs in 2007. Since this initial groundbreaking study, other states have completed similar studies with similar results. SANDAG and Caltrans have just contracted for a 2016 update of the Border Wait Time Study which will address both wait time impacts and emissions impacts.

### **Proposition 1B (2006) Overview**

Proposition 1B, or “Prop 1B” was approved by California voters in 2006 and authorized the state to issue approximately \$20 billion in general obligation bonds for specific programs to relieve congestion, facilitate freight projects, improve air quality, and increase the safety of the state’s transportation infrastructure. The California Transportation Commission (CTC) was assigned responsibility for programming and allocating approximately \$12 billion of the total amount of funding available through this bond measure.

California’s TCIF program is the most recent example of successful state investment in freight infrastructure. A total of \$2 billion in voter approved transportation infrastructure bonds in 2006 were provided for capital improvements to key freight facilities. The \$2 billion in TCIF funding was used to leverage an additional \$5.2 billion in matching funds from a variety of public and private sources to deliver and construct 81 high-priority seaport, railroad and highway projects for a total investment of \$7.2 billion according to the December 2014 document titled: *California Freight Mobility Plan* prepared by Caltrans.

In addition to the \$2 billion in TCIF funds made available through Prop 1B, SB 88 (2007) allocated \$1 billion of Prop 1B funds to the ARB to create the Goods Movement Emission Reduction Program (GMERP). ARB utilized these funds to maximize the emission reduction



benefits and achieve the earliest possible health risk reduction in communities heavily impacted by freight activities. The GMERP funding resulted in the purchase of over 13,000 pieces of equipment through 2015 resulting in a reduction of over 78,000 tons of NOx and 2,200 tons of particulate matter (PM). GMERP project types included: trucks including those serving ports and rail yards, freight locomotives, electrification of ships at berth at ports, cargo handling equipment, transport refrigeration units (TRUs) and harbor craft.

### **TCIF Overview as Part of Proposition 1B**

A total of \$2 billion was dedicated for the TCIF program out of the \$12 billion available for Prop 1B programs administered by the CTC. The primary purpose of TCIF was to improve freight movement along trade corridors while reducing diesel particulate matter and other pollutants that impact air quality. Recognizing the critical freight needs in California, the CTC programmed and allocated an additional \$500 million from the State Highway Account for the TCIF program.

Funds in the TCIF were available to the CTC to allocate for infrastructure improvements along federally designated “Trade Corridors of National Significance” in the state or along other corridors within the state that had a high volume of freight movement. Given the mandates of Prop 1B, the CTC held a number of listening sessions throughout the state in the fall of 2007 to seek input from transportation, logistics and environmental stakeholders on how to implement the TCIF. These listening sessions allowed stakeholders to brief the transportation Commissioners on key goods movement issues within their region and to comment on the key elements of implementing the TCIF, including which corridors should be considered of statewide importance; the criteria for making seaport, airport and rail investments; the relative weighting of velocity, throughput, reliability, congestion relief and emission reduction; and the timeframe in which investments should be committed.

Subsequent to the passage of Prop 1B and in response to stakeholder input, the CTC established a TCIF Work Group and held a series of meetings in the fall of 2007. The Work Group included transportation, logistics and environmental stakeholders, as well as representatives from various state governmental agencies. The purpose of the TCIF Work Group was to develop a policy framework for the implementation of the TCIF and for long term strategies for goods movement investments in California. The Work Group focused on several key policy areas involved in implementing the TCIF, including:

- The appropriate programming framework for the TCIF; ensuring the funds were programmed to address the state’s most urgent needs, providing reasonable geographic balance between the state’s regions.
- The role and types of funding match for TCIF dollars.
- The appropriate roles for the public and private sectors in developing, funding and implementing TCIF projects and strategies.

In order to prioritize funding, four corridors were identified. The corridors also allowed for various regional stakeholders to collaborate during the development of TCIF applications. The corridors were:

1. Los Angeles/Inland Empire
2. Bay Area/Central Valley
3. San Diego/Border
4. Other Corridors

As part of the guideline development process, the CTC determined four corridors had a high volume of freight movement and were eligible for TCIF funding. The CTC acknowledged that other regions of the state may have freight infrastructure needs along corridors that have a high volume of goods movement would be eligible for TCIF funding and allowed these regions to nominate projects for consideration.

Based on the input from listening sessions and the Work Group, CTC staff developed guidelines for the TCIF and these guidelines were adopted by the CTC at a special meeting in December 2007. The TCIF Guidelines are available through the following link:

<http://www.catc.ca.gov/programs/tcif.htm>

Eligible projects identified in the 2007 TCIF Guidelines included, but were not limited to the following:

- Highway capacity improvements;
- Freight rail system improvements;
- Port capacity and efficiency projects;
- Truck corridor improvements;
- Improvements that maximize state access to federal border infrastructure funds; and
- Airport ground access improvements.

To be considered for funding, projects were required to include the following eligibility criteria:

1. The project needed to be included in either a state freight plan, or in an adopted regional transportation plan.
2. The project had to demonstrate a 1:1 funding match (local, federal or private funds).
3. Construction had to begin by December 31, 2013.
4. The project had to contribute to corridor or air basin emission reduction of particulates and other pollutants.
5. The project had to stimulate economic activity, enhance trade value and preserve/create jobs.

The following evaluation criteria (or performance measures) were used to select projects for funding:

1. **Throughput** – project provides for increased volume of freight traffic through capacity expansion or operational efficiency.
2. **Velocity** – Project increases the speed of freight traffic moving through the distribution system.
3. **Reliability** – Project reduces the variability and unpredictability of travel time.

4. **Safety** – Project increases the safety of the public, industry workers, and traffic.
5. **Congestion Reduction/Mitigation** – Project reduces daily hours of delay on the system and improves access to freight facilities.
6. **Key Transportation Bottleneck Relief** – Project relieves key freight system bottleneck where forecasts of freight traffic growth rates indicate infrastructure or system needs are inadequate to meet demand.
7. **Multi-Modal Strategy** – Project employs or supports multi-modal strategies to increase port and transportation system throughput while reducing truck vehicle miles/hours traveled.
8. **Interregional Benefits** – Project links regions/corridors to serve statewide or national trade corridor needs.
9. **Air Quality Impact** – Project reduces local and regional emissions of diesel particulate, CO<sub>2</sub>, NO<sub>x</sub> and other pollutants.
10. **Community Impact Mitigation** – Project reduces negative impacts on communities (noise, localized congestion, safety, etc.).
11. **Economic/Jobs Growth** – Project stimulates local economic activity, enhances trade value and preserves/creates jobs.

The TCIF Guidelines promoted a corridor-based approach for the programming of TCIF funds and also recognized and complemented the freight planning work that had already been conducted within the major freight corridors. To promote this corridor-based approach, the CTC developed geographic programming ranges in consultation with Caltrans and the corridor regional agencies. The targets were neither minimums nor maximums; they did not constrain what any agency could propose nor constrain the CTC to program and allocate. The CTC recognized and supported the key role the state played in project identification and integration of statewide freight priorities through a corridor approach. The approximate percentage of TCIF funds received by each region were as follows:

Region	Approx. % TCIF Funds Received
Los Angeles/Inland Empire Corridor	60%
Bay Area/Central Valley Corridors	26%
San Diego/Border Corridor	11%
Other Corridors	3%

AB 268 (2008) codified the CTC’s role in administering the TCIF program adoption and set the corridor programming targets in law. In addition, SB 1228 (2014) continued the existence of the

TCIF program after the expenditure of all Prop. 1B funds, if other freight funding opportunities were identified.

Both public and private freight providers along with other stakeholders overwhelmingly supported the TCIF program, two of the primary reasons included:

1. It clearly articulated state priorities for the TCIF funds and identified four specific key freight corridors.
2. Regional government was able to program specific freight infrastructure projects that achieved the state TCIF goals.

## **Discussion**

Future funding for freight infrastructure should be based on the successful TCIF/GMERP model and ensure the following three goals of the Governor's Executive Order B-32-15 are realistically considered:

1. Establish clear targets to improve freight efficiency;
2. Transition to zero-emission technologies; and
3. Increase the economic competitiveness of California's freight system.

This "TCIF/GMERP-Phase II" program should include many of the key components that made the TCIF and GMERP programs so successful.

## **TCIF-Phase II Should Incorporate Many of the Criteria Identified in New Federal Transportation Act**

On December 4, 2015, the President signed into law the Fixing America's Surface Transportation Act, or "FAST Act". The FAST Act authorizes \$305 billion over federal fiscal years 2016 through 2020 for highway, highway and motor vehicle safety, public transportation, motor carrier safety, hazardous materials safety, rail, and research, technology and statistics programs.

The FAST Act addressed the need for a coordinated national freight strategy, and acknowledged the need to ensure the U.S. maintains its domestic and global economic competitiveness. The FAST Act created the following two funding programs specifically for freight:

- A \$4.5 billion competitive grant program prioritizing "nationally significant freight and highway projects" for urban and rural areas. The program will award grants to entities such as metropolitan planning organizations and port authorities.
- A \$6.3 billion freight formula program aiming to target investments on a newly-designated "National Highway Freight Network" in addition to other critical urban and rural freight corridors. These freight formula funds are to be allocated to each state. Under this category California would receive an estimated \$100 million a year for the next five years.

TCIF/GMERP-Phase II should incorporate the following federal freight goals that were identified in the FAST Act:

1. *Improve the safety, efficiency, and reliability of the movement of freight and people;*
2. *Generate national or regional economic benefits and an increase in the global economic competitiveness of the United States;*
3. *Reduce highway congestion and bottlenecks;*
4. *Improve connectivity between modes of freight transportation;*
5. *Enhance the resiliency of critical highway infrastructure and help protect the environment;*
6. *Improve roadways vital to national energy security; and*
7. *Address the impact of population growth on the movement of people and freight.*

The only freight projects that are eligible to receive these federal freight funds include:

1. *Highway freight projects carried out on the National Highway Freight Network;*
2. *Highway or bridge projects carried out on the National Highway System;*
3. *Projects to add capacity to the Interstate System to improve mobility;*
4. *Projects in a national scenic area;*
5. *Freight projects that are a freight intermodal or freight rail project; or within the boundaries of a public or private freight rail, water (including ports), or intermodal facility that is a surface transportation infrastructure project necessary to facilitate direct intermodal interchange, transfer, or access into or out of the facility; or a railway-highway grade crossing or grade separation project.*

NOTE: The U.S. DOT will need to promulgate final regulations on the federal freight grant program before additional details and requirements on federal freight funding can be clarified.

### **Current State Proposals Regarding Freight Funding**

As of February 2016, there are five state proposals on the table regarding specific funding for freight infrastructure:

#### ***Governor's FY 2016/17 Proposed Budget***

In January 2016, the Governor released his proposed budget for the upcoming fiscal year 2016-17 that contained a transportation package to improve the maintenance of highways and roads, expand public transit, and improve critical freight infrastructure. Over the next ten years, the \$36 billion transportation package would provide \$16 billion for highway repairs and maintenance, and invest over \$2 billion in the state's trade corridors. This would equate to roughly \$3.6 billion available annually. Local roads would receive more than \$13 billion in new funding over the next ten years. Over \$4 billion in additional funding would flow to transit and intercity rail; half of these transit and intercity rail funds would be allocated to benefit the state's disadvantaged communities.

If approved as proposed by the Governor, this transportation package would allocate \$211 million per year to fund projects along the state's major trade corridors.

### *California Senate Bill X1-1 (Beall)*

Senator Jim Beall's proposal increases funding primarily to address the maintenance backlog for California's transportation system. Senator Beall's proposal would raise a total of \$6 billion annually; of that total, \$5.5 billion would be dedicated for improvements to existing roads and highways and \$500 million to improve freight infrastructure.

### *California Assembly Bill 1591 (Frazier)*

In January of this year, Assembly Member Jim Frazier introduced AB 1591 which would raise over \$7 billion annually and fund two major initiatives: 1) trade corridor improvements; and 2) road maintenance and rehabilitation. This bill would annually provide almost \$6 billion for existing roads and highways; \$1.2 billion for freight infrastructure; \$600 million in Cap and Trade funds for transit and rail improvements; and \$200 million for Complete Streets.

In addition to the three proposals above, the following two legislative bills were introduced in January/February 2016 relating to freight projects and the use of Greenhouse Gas Reduction Funds; commonly referred to as "Cap and Trade":

- **AB 1780** (Medina) would establish the Sustainable Trade Corridors Program. 25% of the annual Cap and Trade proceeds would be used to fund this program which would be administered by the CTC.
- **AB 1657** (O'Donnell) would establish the Zero and Near-Zero Emission Intermodal Terminals Program. This program would fund equipment upgrades and investments at intermodal terminals and would be administered by the ARB. The bill would also create the Port Building and Lighting Efficiency Greenhouse Gas Reduction Fund Program to be administered by the California Energy Commission.

### **TCIF/GMERP-Phase II**

The main goal of TCIF/GMERP-Phase II would be to support the development of freight infrastructure and clean equipment projects that address the three goals of the Governor's Executive Order B-32-15. The subgroup offers the following nine recommendations (below) regarding possible performance measures/selection criteria for TCIF/GMERP-Phase II. These are intended to establish a baseline of possible items which could be used by the state to set general project selection criteria; as with the TCIF, a TCIF/GMERP-Phase II program would rely on regional agencies to select specific projects. The suggested TCIF/GMERP-Phase II project selection criteria address Federal FAST Act requirements and the Governors Executive Order B-32-15:

1. **GHG and Federal Criteria Emission Reductions** – Project will have a positive impact in reducing CO<sub>2</sub> emissions and federal criteria air pollutants.
2. **Throughput** – Project provides for increased volume of freight traffic through capacity expansion, connectivity or operational efficiency.
3. **Safety** – Project increases the safety of the public, industry workers, and traffic.
4. **Community Impact Mitigation** – Project reduces negative impacts on communities (noise, localized congestion, safety, etc.).

5. **Economic/Jobs Growth** – Project stimulates local economic activity, enhances trade value and preserves/creates jobs.
6. **Promotes Innovation** – Project includes technological innovation that address efficiency, reduces environmental impacts, or both.
7. **Resiliency** – Project will reduce climate change related impacts to freight infrastructure.
8. **Security** – Project will enhance the security of port or rail facilities.
9. **Impacts to Disadvantaged Communities** – Project will reduce the impact of freight facilities/movement to disadvantaged communities.

As specified in SB 1228 (2014), TCIF/GMERP-Phase II eligible freight infrastructure projects would be selected from the following documents:

- **California Freight Mobility Plan** - Prepared by Caltrans
- **Sustainable Freight Strategy** - Prepared by ARB
- **Goods Movement Action Plan (2007)** - Prepared by Caltrans
- **Freight Plans** - Prepared by regional transportation agencies
- **Adopted Regional Transportation Plans** - Prepared by Metropolitan Planning Organizations and Regional Transportation Planning Agencies
- **State Port Master Plan** - Prepared by the California Marine and Intermodal Transportation System Advisory Council

ARB would be responsible for continuing to specify eligible clean equipment requirements. It is important for the project listing in each of these documents to be updated regularly to ensure the lists represent current regional needs. Prioritization of projects under TCIF/GMERP-Phase II should also ensure that in addition to consideration of Port and truck related improvements, the importance of freight rail projects are also addressed.

Under SB 1228, eligible freight infrastructure projects include:

- Highway capacity and operational improvements;
- Freight rail system improvements;
- Projects to enhance the capacity and efficiency of ports;
- Truck corridor improvements, truck facilities, or truck toll facilities;
- Border access improvements; and
- Surface transportation and connector road improvements

## **Recommendations**

Listed below are the recommendations developed by the subgroup regarding possible state allocation of funding for freight infrastructure and clean equipment improvements:

1. **Continue the Successful TCIF Program With a “TCIF/GMERP-Phase II”**

- All future funding dedicated for freight infrastructure improvements and allocated by the state should use the Trade Corridors Improvement Fund (TCIF) program as a model, this new program could be called “TCIF/GMERP-Phase II”.
  - All future funding dedicated for clean equipment purchases should be administered by ARB.
  - TCIF/GMERP-Phase II should incorporate many of the aspects of the original TCIF program (including the aforementioned regional shares). In addition, updates may be necessary to meet performance measures/selection criteria and other FAST Act requirements as well as the Governor’s Executive Order B-32-15.
  - As occurred during the TCIF process using Prop. 1B funds, TCIF/GMERP-Phase II will require on-going direct communication between state, regional and local government in addition to the private freight industry.
  - SB 1228 (2014) continued the existence of the TCIF Program and allowed for funds other than the original Prop 1B funding to be allocated by the CTC. The first opportunity to implement TCIF/GMERP-Phase II would be with the recently approved federal transportation reauthorization referred to as the “FAST Act”. The FAST Act authorizes approximately \$100 million per year to California for the next five years. Other federal or state funds dedicated for freight infrastructure could be included into TCIF/GMERP-Phase II as they are made available.
  - The state legislature needs to introduce implementing legislation for FAST Act freight funding.
- 2. Ensure TCIF/GMERP-Phase II Funds are Leveraged With Other Funding Sources**
    - TCIF/GMERP-Phase II funds should be heavily leveraged with other public and private funding sources.
  - 3. Develop a Long-Term Funding Program Specifically for Freight Infrastructure and Clean Equipment**
    - California should develop a long-term dedicated freight infrastructure and clean equipment funding program as articulated in the Governor’s FY 2016-17 proposed budget and also identified in both Senator Beall’s and Assembly Member Frazier’s legislative proposals.
  - 4. Build on the GMERP Program with the Dedication of Cap-And-Trade Funds for Freight Infrastructure and Clean Equipment Which Will Reduce Freight Emissions**
    - Cap-and-Trade revenues should be dedicated for use within “Sustainable Trade Corridors” and at “Zero and Near-Zero Emission Intermodal Terminals” like as proposed in AB 1657 (O’Donnell) and AB 1780 (Medina). Other funding sources should be identified in addition to Cap-and-Trade funds. These programs would fund equipment upgrades and investments throughout the state’s trade corridors, as identified in TCIF, and including additional funding for equipment upgrades and infrastructure investments at intermodal marine terminals.
  - 5. Minimize the Complexity of State Administered Freight Funding Programs**



- If additional funding is identified for freight infrastructure or equipment projects, the complexity and requirements of those programs should be held to a minimum. In addition, freight capital improvement projects should be administered by the CTC, clean freight equipment programs should be administered by the ARB, and the California Energy Commission should administer programs aimed at reducing freight related energy consumption. As best possible, the grant application requirements should be similar between state agencies.

**6. Improve Existing Access Infrastructure to California's Major Port Facilities**

- Any additional state funding for freight infrastructure should take into consideration the improvement of access to major port facilities. Existing key highway and road access near California's major port facilities must be maintained and improved. Local government should take into consideration how decisions to reduce access to these facilities may have a severe impact to statewide economic competitiveness.

**7. Underwrite Present Capital Expenses In Anticipation of Future Benefits**

- If the state can identify direct efficiency, environmental and economic benefits which will result from an investment in freight infrastructure, and these benefits include future savings with respect to public expenditures or future revenues with respect to state tax collection, then the present value of the investment can be monetized by the state. If the value of an investment can be monetized it can be used as a basis for underwriting the financing of the investment. Not unlike tax increment financing and similar to other revenue bonding models which exist for various types of infrastructure at the state and local levels, the state can and should utilize its ability to leverage current investment in the freight network on the basis of achieving its goals and ensuring the creation of future benefits. The opportunities and constraints which are attendant to a monetization and underwriting option should be explored in more detail as the Sustainable Freight Action Plan is developed not only from an efficiency perspective, but also with respect to improving economic competitiveness and zero-emissions equipment finance.

# STRATEGIES TO MAXIMIZE ASSET UTILIZATION IN THE CALIFORNIA FREIGHT SYSTEM: PART I – BACKGROUND AND GENERAL RECOMMENDATIONS

March 2016

A White Paper from the Freight Efficiency  
Strategies Development Group

**Lead Author:** Miguel Jaller, University of California, Davis  
**Working Group Members:** James Jack, Coalition for Responsible  
Transportation; Cynthia Cory, California Air Resources Board; Chris  
Shimoda, California Trucking Association; Mike Jacob, Pacific  
Merchant Shipping Association; and Kerry Cartwright, Port of Los  
Angeles

## **About the Freight Efficiency Strategies Development Group**

In July 2015, Governor Jerry Brown issued Executive Order B-32-15, directing several state agencies to work together in developing an integrated action plan that will “establish clear targets to improve freight efficiency, transition to zero-emission technologies, and increase competitiveness of California’s freight system” and that the plan should “identify state policies, programs, and investments to achieve these targets”. In response, an interagency group was formed to oversee the development of the California Sustainable Freight Action Plan (CSFAP). Members of the interagency group include the California Air Resources Board, the California Department of Transportation (Caltrans), the California Energy Commission (CEC), and the Governor’s Office of Business and Economic Development (GO-Biz). As part of developing the plan, the interagency group has solicited feedback from a broad range of stakeholders through a variety of engagement activities and outreach efforts. A component of this engagement was the development of the Freight Efficiency Strategies Development Group (FESDG) made up of freight experts from academia, industry, and government. The purpose and main task of this group was to produce a series of white papers that identify promising strategies for increasing the efficiency of the freight system. A series of six papers were developed over the course of six months. Each paper focuses on a specific theme for increasing freight efficiency within the larger freight system.

## **About the National Center for Sustainable Transportation**

The National Center for Sustainable Transportation is a consortium of leading universities committed to advancing an environmentally sustainable transportation system through cutting-edge research, direct policy engagement, and education of our future leaders. Consortium members include: University of California, Davis; University of California, Riverside; University of Southern California; California State University, Long Beach; Georgia Institute of Technology; and University of Vermont. More information can be found at: [ncst.ucdavis.edu](http://ncst.ucdavis.edu).

## **Disclaimer**

The content of the white papers produced by the group represents discussions among many individuals representing various freight industry stakeholders. It may not reflect consensus on the part of all of the participants, nor do these papers necessarily represent the official opinion or policy of the represented organizations, but rather a range of thinking that might be used to inform and build consensus for the development of the California Sustainable Freight Action Plan. Given the perspective of the various freight stakeholders, paper authors have attempted to include dissenting opinions and areas of concurrence where they may exist. This document is disseminated under the sponsorship of the United States Department of Transportation’s University Transportation Centers program, in the interest of information exchange. The U.S. Government and the State of California assumes no liability for the contents or use thereof. Nor does the content necessarily reflect the official views or policies of the U.S. Government and the State of California. This report does not constitute a standard, specification, or regulation.

## **Acknowledgments**

This study was funded by a grant from the National Center for Sustainable Transportation (NCST), supported by USDOT and Caltrans through the University Transportation Centers program. The authors would like to thank the NCST, USDOT, and Caltrans for their support of university-based research in transportation, and especially for the funding provided in support of this project.

[page left intentionally blank]

## TABLE OF CONTENTS

EXECUTIVE SUMMARY .....	3
Abstract.....	6
Introduction and Background .....	6
Overview of the Freight System.....	7
Key stakeholders, their roles and interactions.....	7
Cargo and Vehicle Movements .....	8
Inefficiencies in the Freight System .....	10
Inefficiencies in the On-road Trucking Sector .....	10
Inefficiencies in the Maritime Sector .....	15
Summary and General Recommendations .....	17

# Funding for Freight Infrastructure & Clean Equipment

## EXECUTIVE SUMMARY

The freight system is one of the key contributors to a healthy economy. However, the vehicles, equipment, and facilities used by the different economic agents that conduct freight operations produce significant externalities: congestion, environmental emissions, and safety issues, among other impacts. Therefore, public and private initiatives, measures, or strategies to mitigate these negative externalities, and move the system onto a more sustainable path, are a priority.

In response to this need, the Freight Efficiency Strategy Development Group (FESDG), a collaborative effort between academia, public and private stakeholders, and government, was convened in August 2015 with the ultimate goal of identifying freight system inefficiencies in California and developing a set of efficiency improvement strategies.

This paper (Part I of a two-part series) discusses key findings from the effort. It provides an overview of the freight system in terms of the main stakeholders, their roles and interactions; the impacts from the type of vehicles used to move cargo in, out and throughout the State; and various pressing inefficiencies.

When investigating the dynamic among the stakeholders, several key points are identified:

- The industry objectives, business models, and regulatory compliance requirements associated with each of the large number of stakeholders are some of the factors that evidence the system's complexity.
- Although there is multiplicity of stakeholders, the performance of the system may be driven by the decisions of a limited number of players who have with greater decision-making powers (e.g., shippers, receivers).
- Designing policies or strategies to foster behavioral shifts and efficiency improvements requires identifying the appropriate decision maker capable of influencing such change.
- The freight system is comprised of a number of supply chains, each with different operational patterns (e.g., distributive networks, spoke and wheel patterns, corridors).
- Freight activity manifests itself in different forms, depending on the layer of the economy: 1) international trade economy freight gateways (i.e., seaports, airports, land ports of entry); 2) domestic manufacturing/agricultural economy; and 3) the distribution and urban economy.
- Although usually overlooked, the freight traffic generated by the domestic manufacturing/agricultural and distribution economies is a magnitude larger than traffic generated by the international trade layers.

There are myriad types of efficiencies and inefficiencies worth discussion:

- The freight system experiences high levels of pressure from both external and internal factors. Government, market, and environmental conditions require the system's

players to squeeze profit margins, in some cases, creating inefficiencies at the expense of other players and even at the expense of their own sub-systems.

- Due to the silo nature of the freight system components, efficiency gains at the sub-system level do not tend to equate to net gains in terms of a system optimum.
- Congestion, highway capacity, safety, geometrics, surface conditions, and intermodal connections are key concerns of the trucking industry.
- There are several corridors and freight bottlenecks affecting the efficiency of goods and passenger movements in different regions of the State.
- Congestion (in its various forms) is an important factor contributing to the system's inefficiencies.
- The share of accidents caused by trucks is small; however, accidents involving heavy-duty vehicles are more likely to result in fatalities.
- There are issues with truck routes and freight planning.
- Inefficiencies associated with the bulk of freight vehicle movements, and with the last mile and distribution economy, are the result of a lack of planning and consideration for the freight industry in general planning processes; the importance of the last mile and distribution economy has been neglected in particular.
- The general public and some public officials, usually associate the major freight issues with on-road motor carriers. However, these carriers are only the conduit between points of origin and destination; because of how the system works, shippers and receivers tend to be the ultimate decision makers that determine how, when, and where freight operations occur.
- Hours of Service Rules, especially the Hours of Service of Drivers Final Rule of 2011, if implemented, could introduce additional inefficiencies in the freight system.
- There are concerns in the trucking industry about the predicted shortage of qualified truck drivers.
- Within the seaports, congestion and inefficiency can be seen at the intersections of multiple portions of the supply chain and multi-modal transactions across multiple business lines, all in one concentrated node.
- Port labor disruptions during contract negotiations, and/or lack of new terminal infrastructure, can impact California's economic competitiveness.
- International cargo movement patterns that translate into congestion at seaports can also result in significant delays for trucks looking to pick up and drop off cargo. However, inefficiencies do not only affect the land side of marine terminals. Vessel loading and discharge is also susceptible to congestion, at a great expense to vessel operators.

In light of the Governor's Executive Order, it is imperative that California's various public agencies initiate, continue, or reinforce efforts to address freight efficiency issues such as those outlined above. These efforts should, in general, concentrate on:

- Conducting sound freight planning at all levels; with emphasis on urban freight.
- Identifying behaviors that need to be fostered, or mitigated, among the various stakeholders.



- Developing participatory stakeholder engagement.
- Fostering information sharing.
- Developing plans, agreements and platforms for active conversation to address labor issues; and invest in workforce development.
- Investing in research and continued improvement efforts.

In general, trying to achieve the goal of improving freight efficiency will require coordinated efforts between the public and private sectors, academia, communities, and any other relevant stakeholders. As there are numerous different types of issues identified within the freight system, it is not likely that a single strategy will result in significant improvements. This is a complex system requiring multi-part complex solutions.

## Abstract

This paper (the first of a two-part series) discusses key findings from a collaborative effort between academia, public and private stakeholders, and government to identify strategies to improve the efficiency of California's freight system. In doing so, the paper provides a brief overview of the system, with an emphasis on key stakeholders, their roles and interactions, and implications associated with the types of freight movements and layers of the economy. Moreover, the work discusses major inefficiencies in the on-road trucking and maritime sectors, where congestion often impedes maximizing asset utilization. Part I presents a number of general recommendations to improve freight efficiency; Specific strategies are discussed in the second part of this series. In addition, this paper acknowledges the fact that it is not likely that any single strategy will result in significant-enough improvements on its own; the inherently complex nature of the system will require an equally complex set of solutions.

## Introduction and Background

The freight system is one of the key contributors to a healthy economy. However, the vehicles, equipment, and facilities used by the different economic agents that conduct freight operations produce significant externalities including congestion, environmental emissions, and safety issues, among other impacts. Therefore, public and private initiatives, measures, or strategies to mitigate negative impacts and move the system towards a more sustainable path are a priority. In general, the type of strategies that could be implemented range from infrastructure improvements and technological advancements to freight transportation demand management strategies (which focus on behavioral changes). Although infrastructure and technology enhancements are essential components of a comprehensive improvement strategy, these alone cannot address underlying behavioral aspects that translate into system inefficiencies.

This concept is even more acute in a geographic location such as California, where important large traffic generators such as the maritime ports, international border, extensive agriculture and production lands, and huge consumption demand in its large metropolitan areas interact and exhibit diverse freight patterns, operations, and issues. The freight system experiences high levels of pressure from both external and internal factors. Government, the market, and environmental conditions require the system's players to squeeze profit margins, in some cases, creating inefficiencies at the expense of other players and even sub-systems. Moreover, efficiency gains at the various sub-systems do not equate to a system optimum. Therefore, putting forward a plan to improve the efficiency of the California freight system as a whole requires an understanding of its multiple stakeholders, industry relations, and the current opportunities and constraints faced by the system.

In this sense, Part I discusses some of the findings from the Freight Efficiency Strategy Development Group (FESDG). The FESDG is a collaborative effort between academia, public and private stakeholders, and government, sponsored by the California Department of Transportation (CALTRANS) and the Air Resources Board (ARB). A number of stakeholders have been convening since August 2015, with the ultimate goal of identifying inefficiencies faced by the freight system and putting forward a set of strategies to achieve a more efficient freight

system. In doing so, a key first step was to provide insight as to the possible root cause(s) of major inefficiencies affecting the system.

In addition to assessing inefficiencies, this paper describes some of the aspects and necessary conditions that need to be considered when defining or identifying remediating strategies. Specific strategies are then discussed in a companion paper.

This paper is organized as follows. Section II provides a brief overview of the California freight system, emphasizing key stakeholders, their roles and interactions. Section III discusses major inefficiencies affecting the system. Section IV provides a summary and discusses crucial points to be considered in the development of improvement strategies.

## Overview of the Freight System

### Key stakeholders, their roles and interactions

At first glance, various stakeholders in the California freight system can be clearly identified. These include carrier companies (e.g., rail, ocean vessel, truckers, etc.); shippers; receivers (e.g., beneficiary cargo owners, retailers, manufacturers, farms, businesses, households); public agencies; terminal, distribution, warehousing and ancillary facility operators; intermediaries and logistics operators; regulators; the general public; trade organizations; unions; law enforcement; and, non-governmental organizations.

According to the California Freight Mobility Plan<sup>1</sup>, the current core freight system includes:

- Twelve deep water seaports (11 private and 1 public),
- Numerous private port and terminal facilities,
- Twelve airports with major cargo operations,
- Two Class I railroads and twenty-six short-line railroads operating over approximately 6,000 miles of railroad track,
- Approximately 5,800 center-line miles of high-traffic-volume interstate and state highways,
- Three existing, and one future, commercial land border ports of entry (POE) with Mexico,
- Intermodal transfer facilities,
- Approximately 19,370 miles of hazardous liquid (includes crude oil, refined petroleum products, and other highly volatile liquids) and natural gas pipelines,
- A vast warehousing and distribution sector, and
- Numerous local connector roads that complete the “last mile.”

The sheer number of stakeholders (each with their own objectives, business models, regulatory compliance requirements, and areas of influence), makes describing their interactions, and even understanding the impact of efficiency improvement strategies, a daunting task. Within the system, there are numerous market forces that affect the way each individual player performs and the role that it plays; each subset of each supply chain aims to achieve the same end goal: to maximize its own utility and efficiency, and to minimize its own cost of doing

---

<sup>1</sup> California Department of Transportation, California Freight Mobility Plan (Final) Chapter 2.1 ~ 2.3, 2013.

business. It is important to note,, as discussed before, that each individual player acting to maximize its own efficiency does not guarantee achieving a greater total systems efficiency.

At this point, it is important to mention that although all players may be performing inside a supply chain with many stakeholders, the performance of the chain may be driven by the decision of a limited number of them (having increased decision power). In many cases, the shippers and/or the receivers of the cargo are the ones defining the frequency of distribution, mode, routes, and even transaction schedules; with the rest of the players adjusting to these requirements. This highlights the need to fully identify these interactions when designing policies or strategies in order to reach the appropriate decision maker. In general, the effectiveness of any strategies will not only be their ability to address the key problem but also to reach the adequate stakeholder. For example, PierPass congestion charges are successful at shifting cargo from peak demand periods to off-peak demand periods mainly due to the system design where the fees were paid by receivers and not by the motor carrier drayage companies.

### **Cargo and Vehicle Movements**

Describing the freight system requires defining the supply chains that comprise the system. The system does not drive freight; freight demand drives the system. Each supply chain system is made up of thousands of investments in companies, properties, public infrastructure projects, vehicles and pieces of equipment. The different stakeholders that are a part of each supply chain react to the demand for freight. This is the ultimate manifestation of the freight economy, where monetary transactions translate into the movements of goods (and the vehicles that carry them) from points of production to those of (intermediate or final) consumption. To put it in perspective, these manifestations which occur over and over again within the freight system contribute to one-third of the economy and direct and indirect jobs in California.

Most supply chains are distributive networks; others are formed in spoke and wheel patterns or corridors. Some are defined within the boundaries of the State while others span state lines. In some cases, products to be consumed, transformed, or exported in the State, may have already entered and exited the boundaries several times. Some flows of cargo pass through urban areas while others have the urban areas as the destination. This is of great importance since efficiency improvements will not only be needed inside the State but upstream in their out-of-state supply chains. In many cases, last mile challenges and inefficiencies hinder the efficiency gains in the long haul portion of the transport. These impacts will vary across different types of geographies and urban areas.

Without loss of generality, one can assume these areas to be comprised of different levels of three main layers of the economy where freight plays a role: the international trade economy, domestic manufacturing/agricultural economy, and the distribution economy:

- International trade economy freight gateways include seaports, airports, and land ports of entry. Usually, these operations concentrate along specific freight corridors connecting the port or border facilities and import or export facilities such as warehouses and distribution centers or manufacturing plants and farms.
- Domestic manufacturing/agricultural economy include users who build, grow, transform, and store goods. This is an important layer which drives a significant portion

of urban economies (the majority of the production centers are localized in or near urban areas).

- The distribution economy is related to the final consumption of the goods. Traditionally, the final recipients of goods were almost always freight intensive businesses, such as retail, wholesale, and food and beverage, but now direct residential deliveries constitute a growing and significant percentage of urban freight movements.

It is important to highlight that, although usually overlooked, the freight traffic generated by the domestic manufacturing/agricultural and distribution economies are of a magnitude larger than the international trade layers. Table 1 shows the estimated average daily truck trips in Southern California, with the internal<sup>2</sup> truck traffic representing almost 85% of the traffic. This is similar to the proportion of urban goods movements compared to major freight generators in other geographic locations.

Table 1: Daily Regional Truck Trips by Category by County<sup>3</sup>

	Imperial	Los Angeles	Orange	Riverside	San Bernardino	Ventura	Total	Percent
Internal	10,002	550,207	174,631	89,910	112,434	45,781	982,965	84.8%
External*	2,061	47,992	8,046	4,231	7,601	2,347	72,278	6.2%
Port	14	50,585	1,460	659	1,897	104	54,719	4.7%
Intermodal (IMX)	6	5,430	284	197	1,610	44	7,571	0.7%
Secondary	2	5,986	307	128	1,206	20	7,648	0.7%
<b>Total</b>	<b>12,085</b>	<b>660,200</b>	<b>184,728</b>	<b>95,124</b>	<b>124,748</b>	<b>48,295</b>	<b>1,125,181</b>	
<b>Percent</b>	<b>1.0%</b>	<b>58.9%</b>	<b>15.9%</b>	<b>8.2%</b>	<b>10.8%</b>	<b>4.2%</b>		

\* Does not include the trips between external to external SCAG zones (about 10,000 trips)  
Source: SCAG

Each of these economies brings a set of stakeholders and planning needs. Some are multi-modal in nature, while others are dominated by a single mode. Freight operations and patterns can also show a high degree of variability, depending on the composition (percentage of trade, manufacturing and distribution), imposing additional planning and modeling challenges.

While this paper will simplify the freight system in terms of these three layers, supply chains are complex and any further detail would require analysis of additional echelons or intermediary steps of the chain. Each of these layers will also exhibit distinct modes of transport, from large ocean vessel carriers transporting thousands of TEUs to cargo-bikes or even personal parcel deliveries at residential locations. Even at these different scales, the types of inefficiencies could be very similar, yet the approaches to solve them rather distinct.

<sup>2</sup> Internal Truck Trips: These are truck trips that have both an origin and a destination within the SCAG region and are generated by local industries, construction sites, domestic warehouses and truck terminals and residences.

<sup>3</sup> [http://scagrtpsc.net/Documents/2016/draft/d2016RTPSCS\\_GoodsMovement.pdf](http://scagrtpsc.net/Documents/2016/draft/d2016RTPSCS_GoodsMovement.pdf)

## Inefficiencies in the Freight System

In general, inefficiencies in the freight system take the form of congestion, which in turn can result in higher levels of environmental pollution, additional safety conditions, and negative impacts on economic growth and investment.

### Inefficiencies in the On-road Trucking Sector

According to a 1998 state survey of trucking firms,<sup>4</sup> congestion, along with highway capacity, safety, geometrics, surface conditions, and intermodal connections, was a principal concern of the industry. Since that time, growth in freight traffic, over the road or at specific freight bottlenecks have only caused more recurring and predictable congestion in selected locations; while the temporary loss of capacity, or nonrecurring congestion that is caused by incidents, weather, work zones and other disruptions, is still notably widespread even if less predictable<sup>5</sup>.

In California, the major congested highways in the peak period are concentrated in its two largest urban cores, in the San Francisco Bay Area and greater Los Angeles. According to the corridor reliability buffer index, the least reliable corridors in 2010 were<sup>6</sup>:

- Westbound I-80, Alameda County, BTI<sup>7</sup>: 79 percent in the AM peak.
- Westbound SR-22, Orange County, BTI: 75 percent in the AM peak.
- Eastbound SR-91, Orange County, BTI: 74 percent in the PM peak.
- Northbound SR-57, Orange County, BTI: 70 percent in the PM peak.
- Southbound SR-57, Orange County, BTI: 67 percent in the PM peak.

According to the American Transportation Research Institute (ATRI), the Los Angeles metropolitan area had the highest cost to the trucking industry due to congestion with \$1.1 billion added operational costs<sup>8</sup>. Specifically, the top 5 bottlenecks identified are listed below<sup>9</sup>.

- SR-60 at SR-57 in Los Angeles County
- I-710 at I-105 in Los Angeles County
- I-10 at I-15 in San Bernardino County
- I-15 at SR-91 in Riverside County
- I-110 at I-105 in Los Angeles County.

---

<sup>4</sup> Regan, A. C., and Golob, T. F. (1999). Freight operators' perceptions of congestion problems and the application of advanced technologies: Results from a 1998 survey of 1200 companies operating in California. *Transportation Journal*, 57-67.

<sup>5</sup> U.S. Department of Transportation Federal Highway Administration, Freight Management and Operation, [http://ops.fhwa.dot.gov/freight/freight\\_analysis/freight\\_story/congestion.htm](http://ops.fhwa.dot.gov/freight/freight_analysis/freight_story/congestion.htm).

<sup>6</sup> California Department of Transportation, California Freight Mobility Plan (Final) Chapter 2.1 ~ 2.3, 2013.

<sup>7</sup> Buffer Time Index (BTI) is a reliability measure of travel time. Buffer Time is the difference between the average travel time and the 95th percentile travel time as calculated from the annual average. The Index is estimated considering a number of roadway sections (using VMT to weight the various) sections and controlling for the average travel rate across all the sections. In general, the measure could be explained as the extra BTI% travel time that a traveler should allocate due to variations in the amount of congestion delay on a trip.

<sup>8</sup> American Transportation Research Institute (ATRI). Cost of Congestion to the Trucking Industry. April 2014.

<sup>9</sup> American Transportation Research Institute (ATRI). Congestion Impact Analysis of Freight Significant Highway Locations. October 2014.

In addition, the reader is referred to the Goods Movement Appendix in the 2016-2040 Southern California Association of Governments' (SCAG) Regional Transportation Plan<sup>10</sup> for detailed analysis of freight bottlenecks affecting the freight system in the region.

In terms of safety, the California Highway Patrol (CHP) Statewide Integrated Traffic Records System (SWITRS) reported that of the 2,758 total number of fatal traffic collisions in 2010, 235 involved trucks (1 out of 10)<sup>11</sup>. Truck drivers were at fault in only 75 of the incidents, indicating that in fatal collisions between cars and trucks, automobile drivers are far more likely to be at fault than truck drivers. Similar proportions can be found when looking at injury collision statistics. However, though the share of accidents caused by trucks is small, accidents involving heavy-duty vehicles are more likely to result in fatalities.

Other inefficiencies can be associated with lack of information sharing. Some of these problems arise because of the silo nature of current operational patterns, and others stem from technical reasons. Still other transportation planning inefficiencies could take many forms, examples include issues with truck route planning, where the main problems are associated with: discontinuities between jurisdictions; lack of designated routes to developing or planned industry clusters; and wide divergences between designated and de facto truck routes.

The inefficiencies which are associated with the bulk of freight vehicle movements, the last mile and the distribution economy, are the inherent result of a lack of planning and consideration for the freight industry, in general, and neglect of the importance of the last mile and the distribution economy, in particular. Usually, this is the result of lack of visibility by Federal or Regional regulatory or management entities; in others because the "atomization" of the operations does not fall within the traditional definition of freight. This is both in terms of the cargo (volumes) and the vehicles or modes used. However, recent federal initiatives (STAA, ISTEA, SAFETEA-LU, MAP-21 and FAST) have increased the attention for the role of freight movements in urban and metropolitan areas.

On-road motor carriers, especially for-hire, both full truck load (FTL) or less than truck load (LTL) face challenges which are accentuated by the fact that the general public and public officials usually associate the major freight issues to their operations. It is perceived that these are the companies using the vehicles that generate congestion, parking problems, a disproportionate amount of emissions, and accidents (by severity and likelihood of resulting in casualties). However, because of how the system works, these carriers are only the conduit between points of origin and destination (explicitly shippers and receivers decisions) which are the ones that determine how, when, and where those operations occur. Developing strategies that solely focus on these stakeholders, which has been the traditional practice, will not take the system far enough as the additional costs and other system inefficiencies are mainly absorbed by these companies without affecting other legs of the chain.

In addition to the factors discussed before, two aspects represent a threat for efficiency improvements: hours of service rules, and driver shortages. These are discussed next.

---

<sup>10</sup> [http://scagrtpscs.net/Documents/2016/draft/d2016RTPSCS\\_GoodsMovement.pdf](http://scagrtpscs.net/Documents/2016/draft/d2016RTPSCS_GoodsMovement.pdf)

<sup>11</sup> California Department of Transportation, California Freight Mobility Plan (Final) Chapter 2.1 ~ 2.3, 2013.

## Hours of Service Rules

Hours of Service (HOS) rules have topped the list of leading trucking concerns for the past few years (see Figure 1). In 2004, a 34-hour restart was first introduced in hours-of-service rules. HOS have been (and continues to be) revised over the years. The latest update (Hours of Service of Drivers Final Rule) was published in the Federal Register on December 27, 2011, with an effective date of February 27, 2012 and compliance date of remaining provisions on July 1, 2013.

Changes to the 34-hour restart and the 30-minute break were the biggest changes to be made since 2004. The updates added the following changes and provisions to the existing HOS rules:<sup>12</sup>

- 1) **1 a.m. to 5 a.m. Restart Provision:** a valid 34-hour off-duty restart period must include two periods from 1 a.m. to 5 a.m.
- 2) **One Restart per Week Restart Provision:** use of the restart is limited to one time per week (once every 168 hours from the beginning of the prior restart).
- 3) **Rest Break Requirement:** a driver may drive only if 8 hours or less has passed since the end of the driver's last off-duty or sleeper-berth period of at least 30 minutes.

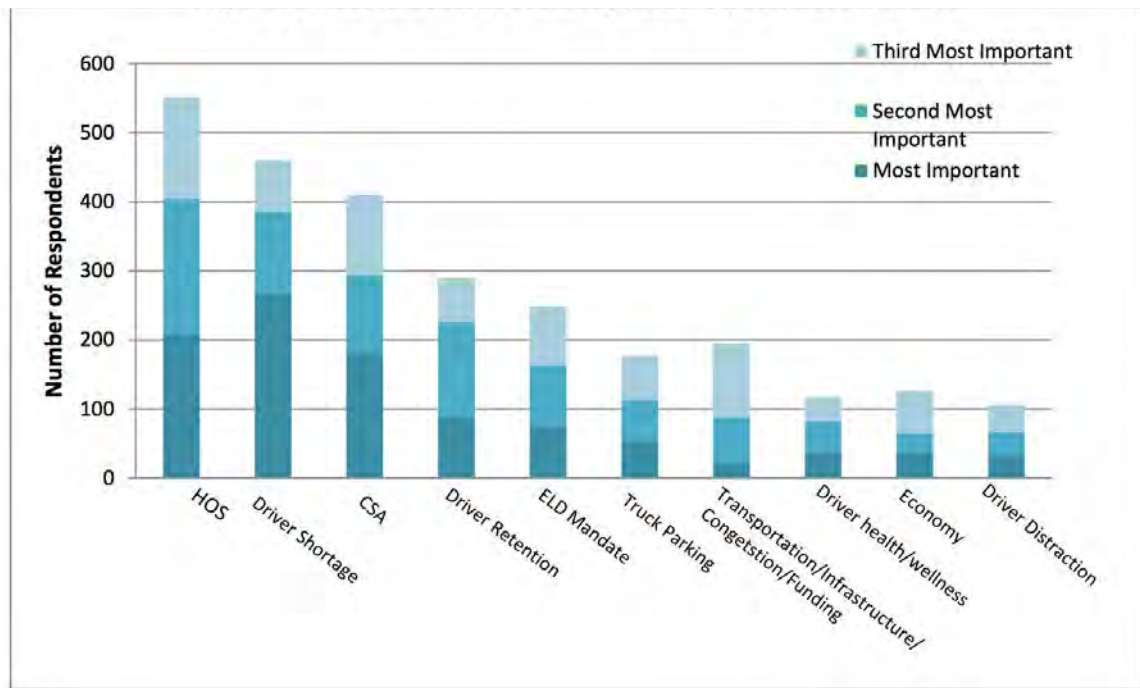

Figure 1: Distribution of industry issue prioritization scores<sup>13</sup>

<sup>12</sup> Federal Motor Carrier Safety Administration - See more at: <https://www.fmcsa.dot.gov/regulations/hours-of-service#sthash.fMoFHwkP.dpuf>

<sup>13</sup> ATRI (2014). Critical Issues in the Trucking Industry. <http://atri-online.org/wp-content/uploads/2014/10/ATRI-2014-Top-Industry-Issues-Report-FINAL.pdf>



The Final Rule, however, was suspended in December 2014. Congress suspended the changes to the restart provisions after trucking groups complained regulators didn't complete a study when developing the rules. Changes, especially the 2 consecutive 1-5am breaks, were broadly opposed by trucking interests. Regulators argued that the rules were meant to increase safety and reduce excessive work hours. The trucking industry claimed that shifting work hours to hours of greater congestion is more risky and that regulators failed to study this properly.

It is imperative that the State carefully addresses the potential negative impacts that the Hours of Service rules can have for freight efficiency, because the enforcement of the restart provisions of the Final Rule would introduce significant inefficiencies in the California Freight System. For instance, it would make difficult for some of the operators that want to participate in extended hours or off-hours operations as it will limit their early travel almost twice per week. Considering the uncertainty in trucking freight operations, the rule could greatly reduce the efficiency of trucking carriers and impede the achievement of the mandate of the Governors' Executive Order. Figure 2 shows a clear example of the inefficiencies that could be introduced by the rule. Depending on the scheduling, the restart rule could translate in a minimum of 1 hour lost and maximum of 17 hours for every restart. This is a major inefficiency as the 34 hour restart rule could become 51 hours. In some cases, due to differences in time zones, this could mean even longer down times. Parking availability is another factor that should be analyzed when evaluating the HOS rule.

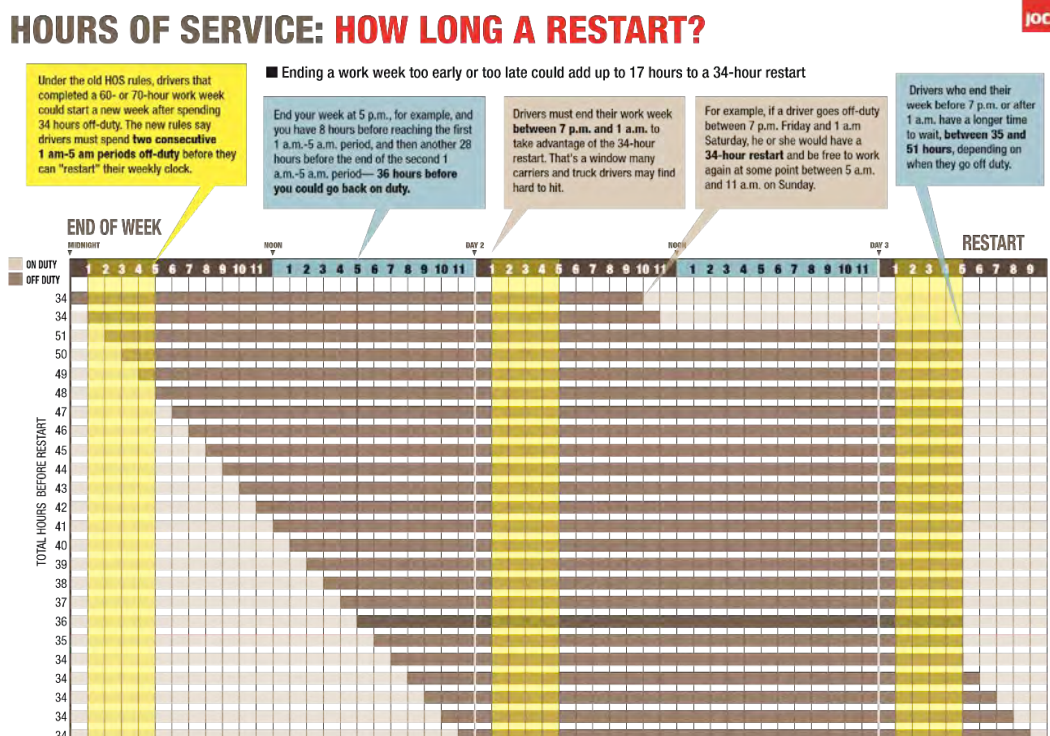

Figure 2: The impact of Hours of Service Rules<sup>14</sup>

<sup>14</sup> <http://www.joc.com/sites/default/files/u48502/InteractiveGraphics/HoursOfServiceRestartChart.pdf>

As a result of the concerns, a study was ordered and scheduled to be reviewed by the U.S. Federal Motor Carrier Safety Administration (FMCSA) and Congress. This report is still pending as of February 2016. Recently, the FMCSA eased concerns that the suspension would be lifted and rules would be reinstated this year. This has been referred to as a regulatory "snapback", and is feared and opposed by trucking and shipping interests. The suspension cannot be lifted until Congress receives the agency's report, but it has been somewhat unclear whether the FMCSA can simply reinstate the suspended rules after the report is delivered, or if Congress must act first.

Concerns associated with trucking hours of service rules include limited productivity and compensation issues. Congress's suspension of the provisions is credited with freeing up as much as 1 to 3 percent of truckload capacity in 2015<sup>15</sup>. "...Team operations were probably most affected...", said Bill Matheson, president of intermodal and logistics services at trucking firm Schneider. "...The rollback gave them probably 2 to 3 percent of their productivity back..." It is also believed that studies are likely underestimating the negative impacts as well, since some drivers may have been cheating the system in order to avoid productivity losses, thus softening the impact seen in reported numbers. In terms of compensation, all truckers are majorly concerned with the possibility of fewer worked hours due to hours of service rules.

### *Driver Shortages*

In addition to hours of service rules, another concern related to labor in the trucking industry is the predicted shortage in qualified truckers. Hiring isn't up, or at the same rate as in past, and retirements mean the loss of experienced drivers.

The key findings from recent reports and news about the driver shortage problem include<sup>16,17</sup>:

"...Over the past 15 years, the trucking industry has periodically struggled with a shortage of truck drivers

In 2014, the trucking industry was short 38,000 drivers. The shortage is expected to reach nearly 48,000 by the end of 2015. If current trends hold it is expected to grow to 175,000 by 2024.

There is also a concern of quality, in 2012, 88% of fleets said that most applicants were simply not qualified.

Over the next decade, the trucking industry will need to hire a total 890,000 new drivers, or an average of 89,000 per year. Replacing retiring truck drivers will be by far the largest factor, accounting for nearly half of new driver hires (45%). The second largest factor will be industry growth, accounting for 33% of new driver hires.

---

<sup>15</sup> [http://www.joc.com/trucking-logistics/labor/hours-service-snapback-put-doubt\\_20150922.html](http://www.joc.com/trucking-logistics/labor/hours-service-snapback-put-doubt_20150922.html)

<sup>16</sup> American Trucking Association (2015). Truck Driver Shortage Analysis. <http://www.trucking.org/ATA%20Docs/News%20and%20Information/Reports%20Trends%20and%20Statistics/10%206%2015%20ATAs%20Driver%20Shortage%20Report%202015.pdf>

<sup>17</sup> <http://www.joc.com/special-topics/driver-shortage>

Of the 7.1 million people employed throughout the economy in jobs related to trucking activity, 3.4 million were truck drivers in 2014. There are over 10 million CDL (Commercial Driver's License) holders in the U.S., but most are not current drivers and not all are truck drivers. There are between 2.5 million and 3 million trucks on the road today that require a driver to have some sort of CDL. Of those trucks, 1.6 million are tractor-trailers. Of those tractor-trailers, no more than 800,000 are used in OTR (i.e., non-local) operations.

The bulk of the driver shortage is for over-the-road (i.e., non-local) drivers operating heavy-duty tractor-trailers (i.e., Class 8 tractors), for-hire truckload sector.

It is highly unlikely that the driver shortage could be reduced in any significant manner through modal shift

Truck driver hours-of-service, reduce industry productivity. Reductions in productivity exacerbate the driver shortage as it requires more trucks, and thus more drivers, to move the same amount of freight..."

In addition, under federal law it is illegal to organize independent drivers. However, advocacy groups such as the teamsters have been organizing drivers under suits claiming "misclassification" as independent contractors. Over the past several years, teamsters and truck drivers have won some lawsuits in CA and some drivers have even been awarded some back wages. Three government agencies (the California Labor commissioner, the regional office of the National Labor Relations Board and the California Employment Development Department) have issued rulings. Unions can legally attempt to organize direct employees, so court victories such as those mentioned above could potentially have a growing impact on the drayage industry. One strategy, in addition to legal action, has been picketing and withholding of driver services, causing delays for all sections of the port system.

### **Inefficiencies in the Maritime Sector**

Within the seaports, congestion and inefficiency are reflected in the intersection of multiple portions of the supply chain and multi-modal transactions across multiple business lines, all in one concentrated node. To illustrate the many business stakeholders involved, Figure 3 shows a dynamic pyramid, with everyone's ultimate customers—the shippers and receivers—on top. These cargo owners determine, in most cases, shipment sizes, frequencies, modes of transport, delivery and transport schedules and locations, and most importantly the demand and the prices that will be paid for services across the intermodal spectrum. At the next layer there are ocean vessel and rail carriers. Their immediate contractual privity to the shippers allows them to have a more dominant role along the chains than port terminals and drayage trucking transport operators. Marine terminal operators and public port authorities maintain highly-leveraged and intensive capital investments, which limit market entry conditions, and are dependent on the cargo volumes provided by ocean and rail carriers, which are demanded by shippers.

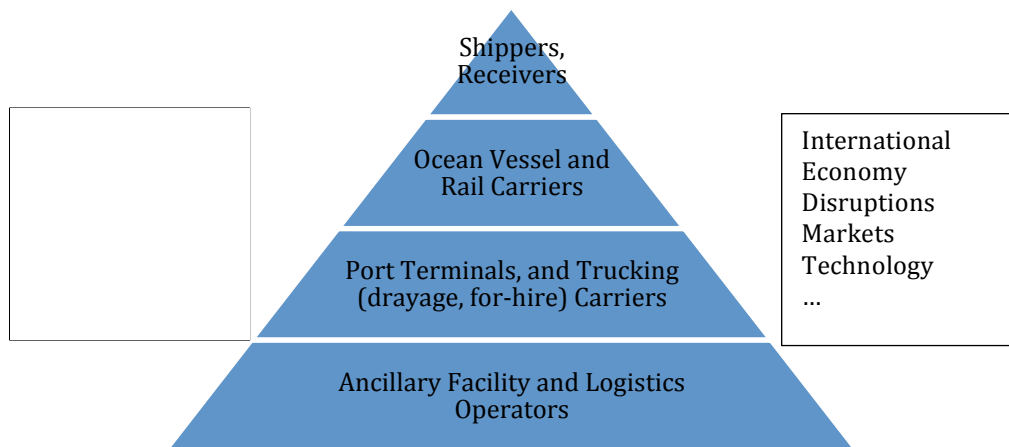

Figure 3: Key Stakeholders of the Freight System

However, the relationship between ocean carriers and port terminal operators is facing increased challenges, especially due to external factors driving changes within the system such as labor, alliances, and congestion at the facilities. For example, recent labor shortages at the main (West Coast) ports due to contract negotiations (about 20,000 dockworkers) accounted for 80% of a bottleneck that impacted 36 vessels idling at sea<sup>18</sup>.

More challenges are posed in the development of ever larger vessels, which can boost vessel operating efficiencies, as well as the increased use of Vessel-Sharing Alliances (VSAs), with most major ocean carriers operating in VSAs of two to six member lines. The direct efficiencies from the vessels are well documented, i.e., > 18,000 TEU vessels provide 50% of more energy efficiency.<sup>19</sup>

Port labor disruptions during contract negotiations and/or lack of new terminal infrastructure can impact California's economic competitiveness. For instance, the impacts in 2014/15 during the protracted contract negotiation resulted in short- and long-term impacts affecting the system whereby many beneficiary cargo owners adopted a "four corner logistics strategy" to diversify their supply chains in order to reduce future vulnerability to labor disruptions at the San Pedro Bay ports. The "four corner logistics strategy" introduces redundancy in supply chains by not concentrating on Southern California, but rather one which relies on seaports in all "four corners" of the U.S. (i.e., southwest, northwest, northeast, and southeast).

Congestion at seaports can also result in significant delays for trucks looking to pick up and drop off cargo<sup>20,21</sup>. Trucks can experience major delays just waiting for dispatch to a seaport, in

<sup>18</sup> Bloomberg business (2015), "Port Deal Near as One Issue Remains, Long Beach Chief Says", February 11, <http://www.bloomberg.com/news/articles/2015-02-11/port-deal-near-as-single-issue-remains-long-beach-chief-says>, accessed October 2015

<sup>19</sup> Kindberg, Lee (2015), "Delivering Sustainability: Ocean Shipping and Supply Chain Efficiency", University of California, Davis, webinar, October 1<sup>st</sup>.

<sup>20</sup> Giuliano, G., Hayden, S., Dell'aquila, P., & O'Brien, T. (2008). *Evaluation of the terminal gate appointment system at the Los Angeles/Long Beach ports* (No. METTRANS Project 04-06). METTRANS Transportation Center.

<sup>21</sup> California Department of Transportation, California Freight Mobility Plan (Final) Chapter 2.1 ~ 2.3, 2013.

addition to queuing outside the terminals and waiting time spent inside the terminals when conducting their transactions. Overall, time spent waiting is a significant inefficiency. This has a direct impact to drayage operations, and represents an opportunity to achieve efficiency improvements.<sup>22</sup> Although truck queues and congestion at port terminals gates generate inefficiencies and other externalities, terminal operators serve their primary customers which are the steamship lines and major import/export companies by managing their internal dock operations under their longshore work rules, leases and contracts, and other constraints<sup>23</sup>. However, inefficiencies not only affect the land side of these terminals. Vessel loading and discharge is also affected at a great expense to vessel operators.

## Summary and General Recommendations

The previous sections discussed some of the key characteristics of the California Freight System. Specifically, the types of stakeholders involved, their dynamic relations, and a number of inefficiencies affecting the system. In light of the Governor's Executive Order, it is imperative that the various public agencies in the State initiate, continue or reinforce efforts to address some of these issues. In general, these efforts should concentrate on:

### *Conducting sound freight planning at all levels*

California is a diverse geographic location in terms of freight, with various requirements and constraints throughout the State. To improve the efficiency, planning should be conducted addressing the needs of the different sectors and layers of the economy. Although, the international trade economy gateways attract much of the attention and can dominate the planning agenda, the domestic manufacturing/agricultural and the distribution urban economies play a key role in the freight system. Consequently, planning resources are required at all levels, from the large Metropolitan Planning Organizations to the local jurisdictions. It is important also to recognize that across all the sectors and economies, congestion (in its various forms) is a key factor that hinders maximizing asset utilization, and should be a priority for planning organizations. Urban freight is also plagued with many inefficiencies such as lack of parking infrastructure, conflicting regulations, and higher costs of conducting business in many large dense areas.

### *Planning efforts will allow identifying the types of freight behaviors that need to be fostered or mitigated among the various stakeholders*

These behavioral changes, will require in most cases, the design of effective incentive programs. These programs could include adequate recognitions programs, financial or non-

---

<sup>21</sup> Barber, D., & Grobar, L. M. (2001). *Implementing a statewide goods movement strategy and performance measurement of goods movement in California*. METRANS Transportation Center.

<sup>22</sup> Haveman J. and K. Monaco (2009). Comprehensive truck management program: economic impact analysis. Available from:  
[http://www.portofoakland.com/pdf/maritime/ctmp/ctmp\\_Beacon\\_Final.pdf?utm\\_source=redirect&utm\\_medium=old\\_site\\_request](http://www.portofoakland.com/pdf/maritime/ctmp/ctmp_Beacon_Final.pdf?utm_source=redirect&utm_medium=old_site_request)

<sup>23</sup> Giuliano, G., & O'Brien, T. (2007). Reducing port-related truck emissions: The terminal gate appointment system at the Ports of Los Angeles and Long Beach. *Transportation Research Part D: Transport and Environment*, 12(7), 460-473.

monetary assistance, or pricing and taxation type of schemes. There are a number of programs in the State trying to achieve higher levels of sustainability. However, these programs do not fully consider operational or logistics changes, and for the most part, concentrate on technological improvements.

### *Participatory stakeholder engagement*

Each individual stakeholder is or has invested great efforts to improve how they operate. Every company has an incentive to invest in technology, planning, and infrastructure in order to streamline their operations and to be more efficient given the pressures of the supply chain. In order to continue being competitive in a market where rates are at their lowest, companies are required to operate with high levels of sophistication and planning. However, while each individual company, industry, or mode is organizing itself in ways which are most effective and efficient for itself, the supply chain as a whole may still benefit from some third-party incentives which create even greater system efficiency. This in turn, requires the development of system level performance measures that are conducive of system-wide efficiencies.

Currently, there are already ongoing efforts for supply chain optimization and port optimization which are resulting in significant improvements and efficiency gains. For example, the Port of Long Beach's Green Port Gateway project, funded by federal and local sources, was finalized in 2015. The main purpose was to improve tracks' infrastructure to enhance rail efficiency and expand on dock capacity in the Port of Long Beach to haul cargo containers directly to and from marine terminals<sup>24</sup>. As a result, 750 truck trips will be avoided by each train. The Port of Long Beach has established a goal of moving 35% of containers by rail in the next 5 years while aiming to achieve a long term target of 50%<sup>25</sup>. The Port of Los Angeles policy is similar: to provide as much rail infrastructure as necessary, and facilitate intermodal logistics such that the movement of direct intermodal cargo (approximately 40-50%, depending upon terminal and steamship line) via on-dock rail is maximized to the greatest extent possible. The results from efforts such as these, highlight the important to recognize the role that planning, collaboration and cooperation, and incentives can have to further produce multi-modal and supply chain efficiencies. Considering how diverse each stakeholder's operations can be, with their own constraints and opportunities, developing appropriate strategies requires insights and detailed analysis of how each supply chain operates. Often this is information that only specific industry experts can provide.

### *Fostering information sharing*

It is important to develop the mechanisms to foster information sharing. Whether it is through Strategy Development Groups, Task Forces or any other collaborative spaces, public agencies should actively engage the various stakeholders in the freight and other sectors to fully identify

---

<sup>24</sup> Port of Long Beach (POLB) (2015c), "Green Port Gateway Rail Project: Fact Sheet", <http://www.polb.com/civica/filebank/blobload.asp?BlobID=10973>, accessed October 2015

<sup>25</sup> Railway technology (2015), "California's Port of Long Beach completes \$93m Green Port Gateway rail project", September 18, <http://www.railway-technology.com/news/newscalifornias-port-of-long-beach-completes-93m-green-port-gateway-rail-project-4673539>, accessed October 2015

the key problems, and develop sound solutions. Furthermore, information sharing may not only be incentivized for planning purposes, but also to recognize the value of information as an input and output to operational processes. All stakeholders participating in this Freight Efficiency Strategy Development Group (FESDG) have identified the need to manage information flows, thus developing information technologies and infrastructure are a must. However, it is also important to understand the full implications of these efforts, because of the very value of information. The resolution of the data, privacy concerns, open or controlled access, the structure of the managing agency, and the validity of the sources, are just a few among the number of factors that need to be addressed when developing such information systems and sharing practices.

### *Other*

While a companion paper focuses on specific strategies to improve asset utilization, it is also important to highlight the need to develop plans, agreements and engage in conversations to address labor issues to optimize such resources. Labor difficulties impact all facets of freight, from modes to facilities. While some of the inefficiencies may be driven by safety concerns and the associated regulations, it is important to consider the full spectrum of impacts that regulations and decisions can have across other operational and tactical factors. Labor issues, such as driver shortages, could also be addressed by investing in workforce development.

### *Investing in research*

In general, trying to achieve the goal of improving freight efficiency will require coordinated efforts between the public and private sectors, academia, communities, and any other stakeholder. It is not likely that a single strategy will result in significant improvements. This is a complex system requiring complex solutions. As a result, it is important that public and private agencies and organizations support research efforts that can help shed light into the various complex issues affecting the system and potential specific solutions.

# STRATEGIES TO MAXIMIZE ASSET UTILIZATION IN THE CALIFORNIA FREIGHT SYSTEM: PART II – STRATEGIES

March 2016

A White Paper from the Freight Efficiency  
Strategies Development Group

**Lead Author:** Miguel Jaller, University of California Davis  
**Working Group Members:** Alison Bird, FedEx; Mike Christensen,  
Port of Long Beach; Chris Shimoda, California Trucking Association;  
Annie Nam, Southern California Association of Governments; Lee  
Kindberg, Maersk Line; Kerry Cartwright, Port of Los Angeles; and  
Elizabeth Fretheim, Walmart



National Center  
for Sustainable  
Transportation

**ITS** UC DAVIS  
INSTITUTE OF TRANSPORTATION STUDIES



## **About the Freight Efficiency Strategies Development Group**

In July 2015, Governor Jerry Brown issued Executive Order B-32-15, directing several state agencies to work together in developing an integrated action plan that will “establish clear targets to improve freight efficiency, transition to zero-emission technologies, and increase competitiveness of California’s freight system” and that the plan should “identify state policies, programs, and investments to achieve these targets”. In response, an interagency group was formed to oversee the development of the California Sustainable Freight Action Plan (CSFAP). Members of the interagency group include the California Air Resources Board, the California Department of Transportation (Caltrans), the California Energy Commission (CEC), and the Governor’s Office of Business and Economic Development (GO-Biz). As part of developing the plan, the interagency group has solicited feedback from a broad range of stakeholders through a variety of engagement activities and outreach efforts. A component of this engagement was the development of the Freight Efficiency Strategies Development Group (FESDG) made up of freight experts from academia, industry, and government. The purpose and main task of this group was to produce a series of white papers that identify promising strategies for increasing the efficiency of the freight system. A series of six papers were developed over the course of six months. Each paper focuses on a specific theme for increasing freight efficiency within the larger freight system.

## **About the National Center for Sustainable Transportation**

The National Center for Sustainable Transportation is a consortium of leading universities committed to advancing an environmentally sustainable transportation system through cutting-edge research, direct policy engagement, and education of our future leaders. Consortium members include: University of California, Davis; University of California, Riverside; University of Southern California; California State University, Long Beach; Georgia Institute of Technology; and University of Vermont. More information can be found at: [ncst.ucdavis.edu](http://ncst.ucdavis.edu).

## **Disclaimer**

The content of the white papers produced by the group represents discussions among many individuals representing various freight industry stakeholders. It may not reflect consensus on the part of all of the participants, nor do these papers necessarily represent the official opinion or policy of the represented organizations, but rather a range of thinking that might be used to inform and build consensus for the development of the California Sustainable Freight Action Plan. Given the perspective of the various freight stakeholders, paper authors have attempted to include dissenting opinions and areas of concurrence where they may exist. This document is disseminated under the sponsorship of the United States Department of Transportation’s University Transportation Centers program, in the interest of information exchange. The U.S. Government and the State of California assumes no liability for the contents or use thereof. Nor does the content necessarily reflect the official views or policies of the U.S. Government and the State of California. This report does not constitute a standard, specification, or regulation.

## **Acknowledgments**

This study was funded by a grant from the National Center for Sustainable Transportation (NCST), supported by USDOT and Caltrans through the University Transportation Centers program. The authors would like to thank the NCST, USDOT, and Caltrans for their support of university-based research in transportation, and especially for the funding provided in support of this project.

[page left intentionally blank]

# TABLE OF CONTENTS

- EXECUTIVE SUMMARY ..... 3
- Abstract..... 6
- Introduction and Background ..... 6
- Improving Performance of the Distribution Economy ..... 9
  - Voluntary Off-Hour Delivery (OHD) Programs (Demand Management)..... 11
  - Receiver-led Consolidation (Collaborative Logistics) ..... 16
- International Gateways..... 17
  - Development of a Chassis Pool of Pools Fully Integrated System (Collaborative Logistics) .... 19
  - Improvement of Traffic Mitigation Fee Programs (Demand Management) ..... 21
  - Implement Advanced Appointment/ Reservation Systems (Demand Management) ..... 23
  - Developing an Integrated System for Dray Operations and Services (Collaborative Logistics)26
  - Load Matching and Maximizing Capacity (Collaborative Logistics) ..... 27
- All Layers of the Economy..... 29
  - Relaxing Vehicle Size and Weight Restrictions (Traffic Management)..... 29
- Summary of Strategies ..... 31

# Strategies to Maximize Asset Utilization in the California Freight System: Part II – Strategies

## EXECUTIVE SUMMARY

This paper (the second of a two-part series) builds upon the discussion of the freight system and key inefficiencies in California (discussed in Part I) and puts forward a set of strategies targeted at improving some of those inefficiencies. The paper focuses on those that could help improve or maximize asset utilization by fostering collaborative logistics (CL) practices and/or freight demand management (FDM). CL practices are defined as those activities initiated, maintained, and/or conducted by different supply chain or freight system stakeholders in which they collaborate, coordinate, or cooperate in terms of resources, knowledge, assets or information to achieve operational or economic efficiency improvements of a larger system. And, FDM strategies are defined as transportation policies that seek to induce changes in demand patterns and freight behaviors to increase economic productivity and/or efficiency, sustainability and environmental justice. Because of the very nature of the system itself, strategies do not work in isolation, and each strategy may require complementary strategies to be feasible and implementable (e.g., sponsored programs to acquire technology, incentives to foster behavioral changes, funding for capital investments).

The paper provides insight into expected impacts, planning, technical and operational requirements, and evaluation metrics for each strategy by analyzing a number of factors such as:

- **Nature of the Strategy:** *Collaborative logistics practices (collaboration/cooperation) or freight demand management.*
- **Geographic scope of the inefficiency/improvement strategy:** *Area(s) where the inefficiency is acute, including at international gateways, on-road sections of the distribution network, and urban areas.*
- **Expected benefits:** *Anticipated benefits of the strategies (i.e., reduce congestion, increase environmental sustainability, enhance safety and security, enhance economic competitiveness, increase revenue generation and enhance livability)*
- **Level of implementation effort/time/cost:** *Estimated inputs required.*
- **Primary stakeholders targeted by the strategy:** *Stakeholders directly affected by the strategy.*
- **Stakeholders' role in the implementation/planning effort:** *Stakeholder type(s) and anticipated role(s).*
- **Potential for unintended consequences:** *Any undesirable impacts that could be linked with a strategy.*

The research process included a critical review of the available information (e.g., research reports, operational reports, implementation programs, pilot tests) of current freight operations, discussions and stakeholder engagement (academia, public and private stakeholders, and government) to identify strategies that could help improve the efficiency of the California's freight system. The authors selected geographic scope (e.g., layer of the economy) as a categorical factor and discussed those strategies that would mainly affect the distribution economy and the international gateways. Results from the process allow identifying the following potential strategies:

- **Voluntary Off-Hour Delivery Programs.** *This strategy is based on a voluntary program of pick-up and delivery operations in the off-hours.*
- **Receiver-led Consolidation.** *This type of strategies seeks to foster behavioral changes within supply chains by taking advantage of the power of receivers to push for cargo consolidation.*
- **Development of a Chassis Pool of Pools Fully Integrated System.** *The Development of a Chassis-PoP fully integrated system that seeks to transition the current PoP to an information and management system that provides the adequate type, quantity and quality of chassis available, and offers simplified administrative and billing services.*
- **Improvement of Traffic Mitigation Fee Programs.**
- **Implement Advanced Appointment/ Reservation Systems.** *Seeks to develop and implement an advanced appointment and reservation flexible system that integrates with other information systems to maximize asset utilizations.*
- **Developing an Integrated System for Dray Operations and Services.** *This strategy seeks to foster the development of cooperation and collaborative agreements between drayage operators, beneficial cargo owners, and in some cases, shipping lines and port terminals, to offer a shared service.*
- **Load Matching and Maximizing Capacity.** *There are many variations of load matching; examples include matching empty containers with loads; first come, first take pickups; and platforms to match small loads with available space in containers which are not already full.*
- **Relaxing Vehicle Size and Weight Restrictions.** *Allowing increases in truck length and size would provide the opportunity for significant gains in efficiency for certain portions of the freight industry.*

Each strategy showed that there is variability in the potential for their impacts, the levels of effort needed for their implementation, and the type of stakeholders involved in the planning, research, and implementation phases. Some of the strategies are likely to be widely understood by the practitioner community, while others require careful analysis and implementation to avoid unintended consequences. A qualitative assessment of the strategies showed that these strategies have the potential to generate positive effects in terms of increased operational efficiency, reduced congestion, and improved environmental sustainability; while not generating major impacts on safety, security and enhancing livability. However, the magnitude of those benefits could not be estimated, as additional research, simulation, modeling and analyses are required to identify the corridors, and/or specific locations (or stakeholders) where those benefits would be realized. The analyses also indicate that the development and

implementation of some of these strategies, although mainly to be initiated by the private sector, would require critical external planning, financial and policy support from local/regional/State/Federal government, planning agencies, and other public authorities. And, as also discussed in Part I of this two-part series, the analyses showed that there is no single strategy that could address the range of inefficiencies currently affecting the California Freight System. While some of the strategies are intended to mitigate pressing issues, others could help to adapt and be able to mitigate the impacts of future trends, and operational patterns. Designing a plan to improve the freight efficiency should consider a set or packages of complementary strategies.

## Abstract

This paper (Part II of a two-part series) discusses the key findings from a collaborative effort between academia, public and private stakeholders, and government to identify strategies to improve the efficiency of the California's freight system.

The freight system is multi-faceted and there could be a myriad of potential strategies; however, the paper focuses on those that could improve or help maximize asset utilization by fostering collaborative logistics (CL) practices and/or freight demand management (FDM). The strategies analyzed include: receiver-led consolidation; voluntary off-hour delivery programs; development of an integrated Chassis Pool of Pools; integrated system for dray services; load matching and maximizing capacity; improving Traffic Mitigation Fee programs; implementing advanced appointment and reservation systems; and relaxing vehicle size and weight restrictions. The paper discusses each strategy terms of its nature (CL or FDM); the geographic scope of the inefficiency or implementation; the expected benefits; level of implementation effort/time/cost; the primary stakeholders targeted; the stakeholders' role in the implementation/planning effort; the potential for unintended consequences; and barriers for implementation.

The research showed that there is great variability in the level of data available (e.g., research reports, operational reports, implementation programs, pilot tests) to conduct detailed assessments, highlighting the need for additional efforts to be able to estimate the magnitude of the potential effects of each strategy to reduce inefficiencies (e.g., congestion/delays, environmental emissions, safety, and economic impacts, and costs, among others). However, stakeholder engagement during the research process allowed for a qualitative assessment based on empirical evidence from on-going efforts.

## Introduction and Background

In Part I, we discussed some of the characteristics of the California Freight System, some key inefficiencies, and important aspects to consider when addressing such issues. Part II delves into strategies to address some of those inefficiencies. The freight system is multi-faceted and there could be a myriad of potential strategies. This paper focuses on those that could improve or maximize asset utilization by fostering collaborative logistics (CL) practices and/or freight demand management (FDM) strategies. For the purpose of this paper, CL practices are defined as those activities initiated, maintained, and/or conducted by different supply chain or freight system stakeholders in which they collaborate, coordinate, or cooperate in terms of resources, knowledge, assets or information to achieve operational or economic efficiency improvements of a larger system. And, FDM strategies are defined as transportation policies that seek to induce changes in demand patterns and freight behaviors to increase economic productivity and/or efficiency, sustainability and environmental justice. It is important to make the distinction between FDM and freight traffic control. Freight traffic control strategies try to modify the freight traffic in the network, without consideration of freight demand, i.e., higher tolls in a highway. Instead, FDM strategies try to modify freight demand that could translate into a reduced number of freight trips.



Because of the very nature of the system itself, strategies do not work in isolation, and each strategy may require complementary strategies to be feasible and implementable (e.g., sponsored programs to acquire technology, incentives to foster behavioral changes, funding for capital investments). This is especially the case for collaborative and cooperative based strategies. It has been a long standing practice in the freight system to engage in collaborative or cooperation agreements, whether by sharing information and knowledge or physical assets. This has been the case when facilitated by a third party which can demonstrate ultimate benefits to cargo interests and carriers. Regardless of collaborative and cooperative behaviors, the supply chain also remains an exceptionally competitive place, and consumers around the globe and in your neighborhood alike benefit from the continual downward pressure on the rates paid to transport goods.

The paper discusses some specific strategies and provides insight into expected impacts, planning, technical and operational requirements, and evaluation metrics. **Error! Reference source not found.** shows a summary of the types of suggested improvement strategies.

The key factors identified and analyzed for these strategies include:

- **Nature of the Strategy:** *Collaborative logistics practices (collaboration/cooperation) or freight demand management.* Strategies may fall into either category, or may be a combination of both.
- **Geographic scope of the inefficiency/improvement strategy:** *Area(s) where the inefficiency is acute, including at international gateways, on-road sections of the distribution network, and urban areas.* More detailed geographic scopes can be: statewide, or specific to a layer of the economy, freight corridors, a certain metropolitan area, or particular locations within the State. Considerations of scope acknowledge the fact that the freight system, and the supply chains within it, span across various geographic areas, some of which extend beyond California.
- **Expected benefits:** *Anticipated benefits of the strategies.* Strategies will be able to address specific issues and inefficiencies based on the benefits they are expected to bring about. Benefits may include:
  - Reduced Congestion
  - Increased Environmental Sustainability
  - Enhanced Safety
  - Enhanced Security
  - Enhanced Economic Competitiveness
  - Increased Revenue Generation
  - Enhanced Livability
- **Level of implementation effort/time/cost:** *Estimated inputs required.* While some strategies may require lower levels of implementation and design effort, smaller costs, and shorter implementation scales, others may require large commitments of resources,

coordination, planning and policies. It is important to consider these factors when examining the feasibility and viability of strategic options.

- **Primary stakeholders targeted by the strategy:** *Stakeholders directly affected by the strategy.* Stakeholder types can include: shippers, receivers, or carriers. Defining primary stakeholders helps to identify the types of modes, industries or freight facilities that would be directly impacted by the strategy. This is significant, for instance, because it is important to be able to anticipate details in regards to traffic generation (including heavy-duty traffic, light duty traffic, through-traffic, large traffic generators (e.g., ports, airports, and warehouses), rail, maritime, and inland waterways, among others).
- **Stakeholders’ role in the implementation/planning effort:** *Stakeholder type(s) and anticipated role(s).* Strategies analyzed in this paper will require the participation of various stakeholders. Nearly all efficiency strategies will require private sector stakeholders to take the lead for the successful implementation of such strategies within their supply chains. Additionally, public entities will need to provide critical external planning, financial, or policy support.
- **Potential for unintended consequences:** *Any undesirable impacts that could be linked with a strategy.* It is imperative to analyze, anticipate, and avoid unidentified and unintended consequences. While real world results cannot truly be known until after the implementation of an improvement strategy, steps can be taken to anticipate and avoid any negative consequences. Past experiences can be analyzed to shed light onto potential issues and methods to circumvent such issues.

Table 1: Summary of Strategies

Layer of the Economy	Nature of the Strategy	Strategy
Distribution Economy	Collaboration/ Cooperation	Receiver-Led Consolidation
	Freight Demand Management	Voluntary Off-Hour Deliveries
Trade and Manufacturing Economies	Collaboration/ Cooperation	[Chassis] Pool of Pools (C-PoP)
		Integrated Dray Services
	Freight Demand Management	Load Matching/ Maximizing Capacity
		Improving Traffic Mitigation Fee Programs
All	Traffic Management	Implement Advanced Appointment/Reservation Systems
		Relaxing Vehicle Size and Weight Restrictions

The remainder of this paper will discuss in Section II, those strategies related to the distribution economy; Section III focuses on the international gateways; and Section IV provides a summary overview of the various strategies with respect to their impacts and other planning factors.

## Improving Performance of the Distribution Economy

The distribution (urban) freight system is usually overlooked, despite the fact that it can represent the vast majority of the freight traffic in a region. This traffic includes freight and services trips to commercial establishments as well as residential locations. As discussed in Part I of this paper series, in some cases, internal distribution can represent up to 80% of the freight traffic<sup>1</sup> and a reduced number of locations (large building, conglomerate of establishments) within an urban core may could generate more freight traffic than a seaport or airport<sup>2</sup>.

Transportation policy should ensure that freight is moved as efficiently as possible, as hampering the flow of cargo is bound to have a negative effect on the economy. Improving the efficiency of the system guarantees that freight shipments are reliable and arrive on time so that there are no economic losses due to lost sales. In addition, reliable operations would increase business throughput by an efficient supply of raw materials. A recent project funded by the (Transportation Research Board) National Cooperative Freight Research Program (Project Report 33) conducted an in-depth analysis of the various public and private sector strategies that could be implemented to improve freight systems performance in metropolitan areas<sup>3</sup>. The report produced a comprehensive classification and critical examination of the national and international evidence concerning their overall performance. More than 40 main strategies are discussed and grouped into seven major categories. Advantages, limitations, planning needs and efforts are discussed for each of the strategies. These range from those addressing supply at one end and demand at the other end. Operational and financial strategies are in the middle of the continuum. The categories include: Infrastructure Management; Parking/Loading Areas Management; Vehicle-Related Strategies; Traffic Management; Pricing, Incentives and Taxation; Logistical Management; and Freight Demand/Land Use Management (see Figure 1).

---

<sup>1</sup> [http://scagrtpscs.net/Documents/2016/draft/d2016RTPSCS\\_GoodsMovement.pdf](http://scagrtpscs.net/Documents/2016/draft/d2016RTPSCS_GoodsMovement.pdf)

<sup>2</sup> Jaller, M., X. Wang, and J. Holguín-Veras (2015). Large Urban Freight Traffic Generators: Opportunities for City Logistics Initiatives. *Journal of Transport and Land Use (JTLU)*, 8.1, 1–17

<sup>3</sup> [http://onlinepubs.trb.org/onlinepubs/ncfrp/ncfrp\\_rpt\\_033.pdf](http://onlinepubs.trb.org/onlinepubs/ncfrp/ncfrp_rpt_033.pdf)

Infrastructure Management	<ul style="list-style-type: none"> <li>• Ring Roads, Upgraded Infrastructure, Intermodal Terminals</li> <li>• Removal of geometric constraints, ramps for forklifts</li> </ul>
Parking/Loading Areas Management	<ul style="list-style-type: none"> <li>• On-street parking, loading zones, reservation systems</li> <li>• Off-street parking, enhance building codes, upgraded infrastructure</li> </ul>
Vehicle-related Strategies	<ul style="list-style-type: none"> <li>• Emission standards</li> <li>• Low noise delivery programs</li> </ul>
Traffic Management	<ul style="list-style-type: none"> <li>• Access and vehicle restrictions, truck routes, low emission zones</li> <li>• Traffic control and land management</li> </ul>
Pricing, Incentives and Taxation	<ul style="list-style-type: none"> <li>• Road pricing, parking pricing</li> <li>• Recognition programs, certification, incentives</li> </ul>
Logistical Management	<ul style="list-style-type: none"> <li>• Cargo consolidation</li> <li>• ITS, last mile delivery practices</li> </ul>
Freight/Land Use Management	<ul style="list-style-type: none"> <li>• Off-hour delivery programs, consolidation</li> <li>• Land use policy, large traffic generators</li> </ul>

Figure 1: Urban freight strategies<sup>4</sup>

The report, discusses the potential of some of these strategies to help alleviate major issues such as congestion, environmental and health impacts, and improve quality of life and the competitiveness of the economy. However, the potential results from the implementation of each strategy are dependent on sound planning and implementation efforts. Planning agencies and private sector businesses should carefully analyze the feasibility and applicability of these strategies to their context and specific issues.

One key aspect, related to freight efficiency in urban areas is the adequate allocation and management of parking, loading and unloading areas<sup>5</sup>. In many locations, curb space is required to conduct freight operations (freight pick-ups and deliveries); but at the same time, other users are constantly competing for the scarce resource. In other cases, assigning the highest priority to freight may still require additional operational changes to avoid the issues associated with urban freight parking. Freight parking is a key issue for the industry that extends beyond the urban environments. This issue should be in the agenda of any planning and transportation organization. Similar difficulties are experienced when analyzing network capacity. Examples of FDM include off-hour delivery programs which incentivize receivers of the cargo to accept deliveries in the off-hours; and staggered freight programs in which businesses coordinate their deliveries or pick-ups throughout the day, rather than concentrating them in specific time periods (usually during traffic peak periods). Considering the experiences from national and international pilot tests and implementations programs, Voluntary Off-Hour Delivery Programs have the potential to play a key role in the State's effort to improve freight efficiency, as they seek to modify freight behaviors. In terms of CL practices, among the various alternatives, Receiver-led consolidation programs show great potential as they offer similar

<sup>4</sup> [http://onlinepubs.trb.org/onlinepubs/ncfrp/ncfrp\\_rpt\\_033.pdf](http://onlinepubs.trb.org/onlinepubs/ncfrp/ncfrp_rpt_033.pdf)

<sup>5</sup> Jaller, M., J. Holguín-Veras and S. D. Hodge (2013). "Parking in The City: Challenges For Freight Traffic." Transportation Research Record 2379: 46-56.

benefits to traditional cargo consolidation schemes while overcoming some of the limitations and implementation challenges. The following sections will discuss these two strategies.

### **Voluntary Off-Hour Delivery (OHD) Programs (Demand Management)**

Off-hours is usually associated with late evenings and early mornings, though it varies from industry to industry, geographic location and land use. ***This strategy is based on a voluntary program of pick-up and delivery operations in the off-hours.*** Usually, participation is fostered by offering incentives to receiver establishments so that they change behaviors and allow their suppliers or carriers to make OHD. Although participation is voluntary, a successful implementation of the program requires public sector support. At the State or Federal level, public agencies should incorporate the type of funding and resource support needed for the design and implementation of the program into the legislation. The program will then be designed and implemented by local jurisdictions. Funding and support will be needed for the development of the specific types of programs, the design of the incentive scheme, stakeholder engagement and outreach activities, and more importantly for the staff to implement the various activities associated with the program. Although, there are a number of successful experiences, careful design and planning will require additional research to fully understand the freight behaviors in the areas under analysis. The research will help identify the potential target markets for implementation, the types and levels of incentives, the barriers for implementation, and to identify the appropriate performance measures to be used.

The resources required for the incentive program, will directly depend on the type of OHD program. For instance, the type of incentives analyzed in the literature include those that are continuously offered throughout the duration of the program, and those that are given as an initial one-time incentive. Incentives could be monetary or otherwise. The program implementation process in New York City evaluated various types of incentives<sup>6</sup>. The monetary incentives ranged from a one-time incentive of \$500 to a \$50,000 incentive with shift potentials ranging from 10% to 30%. The industry sector of the targeted stakeholders is a key factor determining the reach of an incentive package. Table 2 summarizes some of the studies that have investigated the receiver behavior in relation to the likelihood to participate in the program. In general, research results show that food and retail related industries are more likely to participate. Similarly,

Table 3 shows the results for two different (but contiguous) locations in New York City.

The various experiences and international studies about the potential implementation of OHD programs indicate that carriers can have direct benefits seen in the form of reductions in travel times during the off-hours (given that lower traffic volumes allow for higher speeds)<sup>7</sup>. In New York City, modest shift percentages can produce benefits of 5% to all network users. Moreover,

---

<sup>6</sup> Jaller, M., and J. Holguín-Veras (2013). "Comparative Analyses of the Stated Behavioral Responses to Off-Hour Delivery Policies". Transportation Research Record (TRR), Journal of the Transportation Research Board. (2379): 18-28.

<sup>7</sup> Holguín-Veras, J., K. Ozbay, A. L. Kornhauser, M. Brom, S. Iyer, W. Yushimito, S. Ukkusuri, B. Allen and M. Silas (2011). "Overall Impacts of Off-Hour Delivery Programs in the New York City Metropolitan Area." Transportation Research Record 2238: 68-76.

during a pilot test conducted in the City, the travel mean speeds from the warehouses to the first stop in the delivery route improved by 70%. Other benefits include:

- Reductions in service/delivery times due to not having to wait for their delivery/parking spot;
- Reduction in idle times since there was no wait for the receiver to accept the cargo;
- Easy access to parking, loading and unloading zones closer to the establishment. This allowed the carrier to unload and transport larger shipments, thus reducing service times, and in some cases, trips to the establishment<sup>8</sup>;
- Reductions in traffic infractions (with pre-implementation infractions in the order of \$500 to \$1,000+ per truck per month); and
- In some cases, travel time reductions allowed carriers to include additional stops per tour, thus minimizing the routes sent to the city. This translates in higher load factors, and asset utilization.

The program, could generate additional costs for carriers including wage differential to drivers in the off-hours; capital investments in information technology systems to improve operations, e.g., routing, dispatching, monitoring; and increased security costs. However, according to interviews and the experiences of the participants, their benefits were higher than the incurred costs. It is important to recognize that some carriers are not able to participate in this type of programs. Parcel and courier services, may not have the ability to participate due to their customers unwillingness to participate, regulatory constraints, access constraints, and hours of operations and service rules, among others.

---

<sup>8</sup> Jaller, M., J. Holguín-Veras, and S. Hodge (2013). Parking in the City: Challenges for Freight Traffic. Transportation Research Record (TRR), Journal of the Transportation Research Board. (2379): 46-56.

Table 2: Summary of behavioral research<sup>9</sup>

Variables	HV 2007	HV 2013	DOM-S 2013	DOM-B 2013
<b>Industry Sector</b>				
Food and beverage stores	*	+++	+	+++
Press and book	*	*	+++	++
Clothing stores	*	+	++	*
Apparel manufacturing	*	++	*	*
Accommodation	*	*	*	++
Non-durable wholesalers	*	+	*	*
Miscellaneous stores	*	+	*	*
Performing arts	*	+	*	*
Furniture stores	*	*	*	+
Personal laundry services	*	-	*	*
<b>Commodity Received</b>				
Commodity: Alcohol	+++	*	*	*
Commodity: Wood Lumber	++	*	*	*
Commodity: Food	+	*	*	*
Commodity: Textiles/clothing	+	*	*	*
Commodity: Medical supplies	+	*	*	*
Commodity: Office supplies	+	*	*	*
Commodity: Paper	+	*	*	*
<b>Incentive</b>				
Tax deduction	++	*	+++	+++
One-time monetary incentive	*	+++	*	*
Trusted vendor	*	+++	*	*
Shipping discounts	++	++	*	*
Public recognition	*	+	*	*
Business support	*	+	*	*
<b>Other receiver attributes</b>				
Type of facility is single	+++	*	*	*
External warehouse	*	*	++	*
Employment	+	*	*	*
Number of vendors	+	*	*	*
Number of deliveries	*	-	*	*

Notation: (\*) denotes not considered or not found statistically significant. (-) denotes a low negative effect. (+) denotes a low positive effect. (++) denotes a moderate positive effect. (+++) denotes a high positive effect. Notes: New York City HV 2007<sup>10</sup>; HV 2013<sup>11</sup>; DOM-S 2013<sup>12</sup> the case of Santander; and DOM-B 2013 the case of Barcelona.

<sup>9</sup> Holguín-Veras, J., I. Sánchez-Díaz, M. Jaller, F. Aros-Vera, S. Campbell, C. Wang, and S. Hodge (2014). Off-Hour Delivery Programs. City Logistics: Mapping The Future. E. Taniguchi and R. Thomson (eds). CRC Press, Taylor & Francis Group, Boca Raton, Fl.

<sup>10</sup> Holguín-Veras, J., M. A. Silas, J. Polimeni and B. Cruz (2007). "An Investigation on the Effectiveness of Joint Receiver-Carrier Policies to Increase Truck Traffic in the Off-Peak Hours: Part I: The Behaviors of Receivers." Networks and Spatial Economics 7(3): 277-295. 10.1007/s11067-006-9002-7

<sup>11</sup> Holguín Veras, J., C. Wang, S. D. Hodge, I. Sánchez-Díaz, S. Campbell, S. Rothbard, M. Jaller, J. Wojtowicz and R. Marquis (2013). "Unassisted Off-Hour Deliveries and Their Role in Urban Freight Demand Management." (in review).

Table 3: Comparative analyses of the behavioral responses to OHD in different geographic areas<sup>13</sup>

Policy	R1: Tax deduction for accepting OHD			R2: Shipping discounts for OHD			C1: Requests from customers and toll savings		C2: Requests from customers and financial rewards	
	Man.		Bro.	Man.		Bro.	Man.	Bro.	Man.	Bro.
	Rec.	Rec.	Int.	Rec.	Rec.	Int.	Car.	Car. / Int.	Car.	Car. / Int.
	+++	++	--	+++		+ (i)	+++ (ii)	++ (ii)	++ (ii)	++ (ii)
							++ (iii)	+++ (iv)	+ (v)	+ (vi)
Industry Segment	Wood/lumber	+	+			++				+
	Medical supplies	+	+		+					-
	Paper	+	-		+			++	+	++
	Alcohol	+			++	--		-		-
	Food	+			+			-	-	-
	Metal	+		++		+				+
	Furniture		+			+	--		-	-
	Electronics		+							
	Stone and concrete					+++	---			-
	Textiles/clothing				+				+++	
	Construction and hardware		--	++		--				
	Office supplies				+					
	Petroleum/coal								++	
	Plastic/rubber		-					++	--	
	Machinery							-	+++	-
	Household goods							-	--	-
Factors impacting the behavioral response to the policies	Number of employees	++			+			+	++	+
	Increased operational costs	--	--					--	--	--
	Hours of operation	-	-						+	+
	Shipments from NJ		++							
	Number of deliveries					+				
	Accessibility to building	---			--			---		-
	No control of delivery times					--				
	Number suppliers				+					
	Truck drivers							++		+
	Containers from Baltimore					++				
	Containers from Connecticut					--				
	Trips to Manhattan							+++		+
	Located in Brooklyn								---	
	Time/distance to first stop								-	-
	Trips to the Bronx and NJ								--	
	Type of facility				++ (vii)					-- (viii)
	Line of business		---					+++ (ix)	+++ (x)	-- (xi)
	Delivering to the Bronx									-
Union regulations							--		-	
Parking related issues							--	-	---	

Most likely to accept OHD (+++) to Least likely to accept OHD (---)

- Notes:
- (i) Only companies that receive and ship
  - (ii) Request from customers
  - (iii) Toll savings only for petroleum/coal, wood/lumber, food, and textiles/clothing industries
  - (iv) Toll savings
  - (v) Financial reward for food, computer/electronics, and textile/clothing industries
  - (vi) Financial reward for machinery/automotive and paper industries
  - (vii) Single
  - (viii) Headquarters
  - (ix) For shipper, 3PL, trucking, warehouse and mover carriers
  - (x) For shipper, manufacture, trucking and warehouse carriers
  - (xi) For Warehouse carriers

<sup>12</sup> Domínguez, A., J. Holguín-Veras and Á. Ibeas (2012). "Receivers' response to new urban freight policies." *Procedia-Social and Behavioral Sciences* 54: 886-896.

<sup>13</sup> Jaller, M., and J. Holguín-Veras (2013). "Comparative Analyses of the Stated Behavioral Responses to Off-Hour Delivery Policies". *Transportation Research Record (TRR), Journal of the Transportation Research Board.* (2379): 18-28.



In the case of receivers, benefits include reliability improvements in the service times, staff optimization, and environmental emissions reductions, among others. For the cases when the establishments are closed during the off-hours, costs may be incurred to hire personnel. Alternatively, unassisted off-hour delivery programs can be developed (use of double door systems, closed circuit TV, remote access control)<sup>14,15</sup>.

An additional benefit from the strategy is the impact in the traffic flow and parking conditions in the implementation area. A parking analysis in New York City revealed that about 25% of the ZIP codes in Manhattan have a demand for freight parking that exceed capacity. Moreover, the study analyzed the benefits of OHD to mitigate the parking issues. In addition to alleviating congestion and parking issues, estimates for New York City show that the program could lead to yearly reductions of 202.7 metric tons of carbon monoxide; 40 tonnes of hydrocarbons; 11.8 tonnes of nitrogen oxide; and 69.9 kg of particulate matter<sup>16</sup>; similar analyses for the Mexico Federal District area indicate that the program could help overall emission between .8% and 4% (see Figure 2)<sup>17</sup>.

One of the key aspects of the program is its voluntary nature. Only those businesses that are able to participate (with or without the incentive package) will do it. However, there are several barriers that could hamper participation: traffic constraints during the off-hours (regulation banning freight vehicles during those periods of time); limited access to the building or businesses; staffing or scheduling; union regulations; overtime costs; driver issues; hours of service rules; safety and security reasons. As mentioned before, the research have shown that receiver participation is vital to the success of the programs, as carriers do not have the ability to impose off-hour delivery times to their customers. It is not recommended that off-hour deliveries be mandated as it could introduce inefficiencies, increase costs and externalities, and reduce economic competitiveness to those freight operations that could not implement them.

Given the body of knowledge about the program, it could be expected that with additional research to explicitly consider specific freight behaviors in California, the Program could be designed and implemented in a relatively short-term. Though, the program would require the involvement of a large number of stakeholders to identify participants, conduct planning and research, pilot test the incentive program, implement and monitor. The design must also pay special attention to mitigating potential noise disturbances and community perceptions. This type of FDM must also be associated with passenger demand management strategies to mitigate the potential issues of induced demand.

---

<sup>14</sup> Holguín-Veras, J., R. Marquis, S. Campbell, J. Wojtowicz, X. Wang, M. Jaller, S. Hodge, S. Rothbard, and R. Goevaers (2013). Fostering the Use of Unassisted Off-Hour Deliveries: Operational and Low Noise Truck Technologies. Transportation Research Record (TRR), Journal of the Transportation Research Board. (2379): 56-63.

<sup>15</sup> Jaller, M., X. Wang, and J. Holguín-Veras (2015). Large Urban Freight Traffic Generators: Opportunities for City Logistics Initiatives. Journal of Transport and Land Use (JTLU), 8.1, 1–17.

<sup>16</sup> Holguín-Veras, J., J.M. Wojtowicz, C. Wang, M. Jaller, X.J. Ban, F. Aros-Vera, S. Campbell, X. Yang, I. Sanchez-Diaz, J. Amaya, C. González-Calderón, R. Marquis, S.D. Hodge, T. Maguire, M. Marsico, S. Zhang, S. Rothbard, K. Ozbay, E.F. Morgul, S. Iyer, K. Xie, and E.E. Ozguven. Integrative Freight Demand Management in the New York City Metropolitan Area: Implementation Phase. United States Department of Transportation, 2013.

<sup>17</sup> Jaller, M., S. Sanchez, J. Green, and M. Fandiño (2016). Quantifying the impacts of sustainable city logistics measures in the Mexico City Metropolitan Area. Transportation Research Procedia. (12):613-626

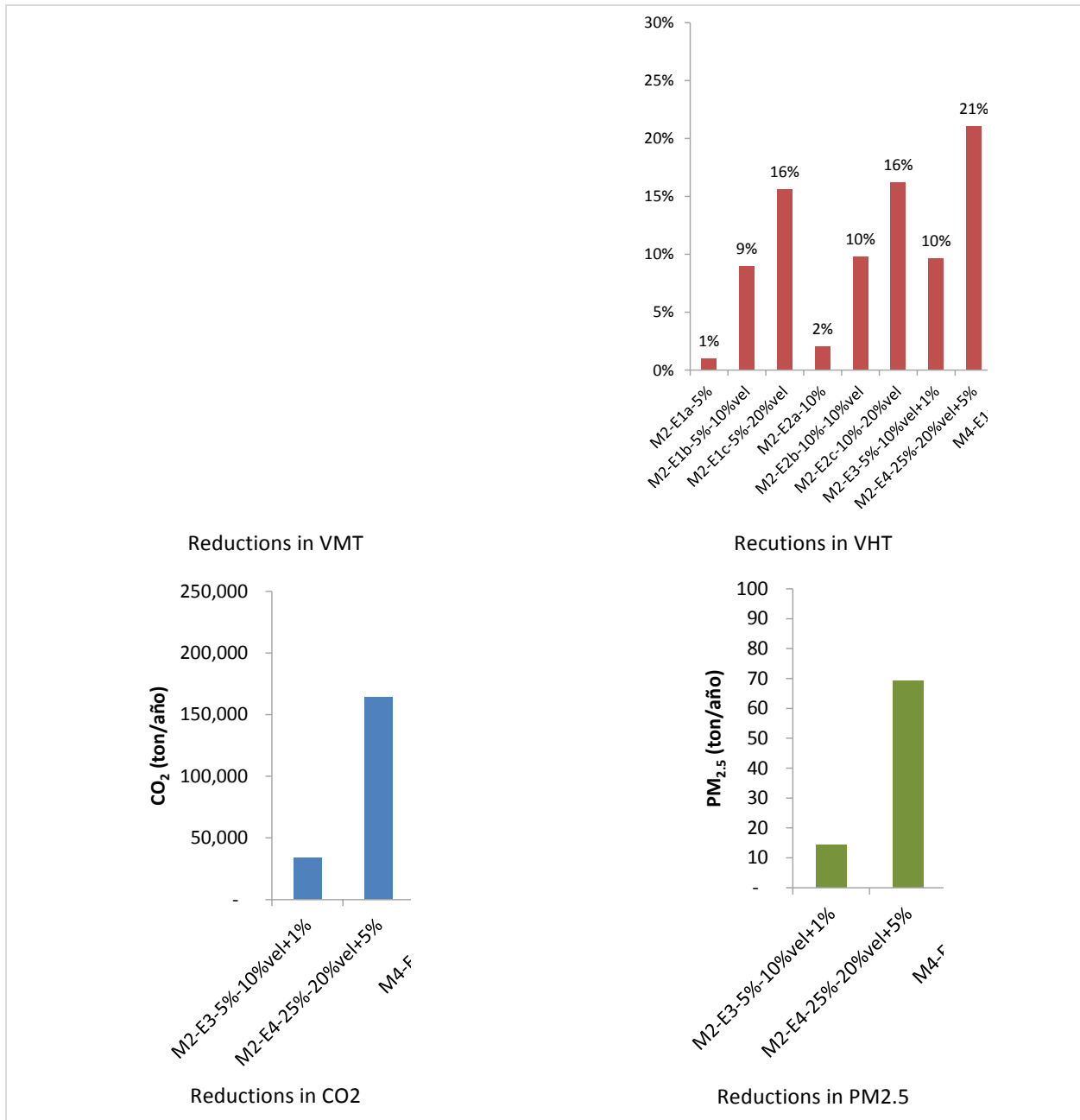

Figure 2: Example potential benefits from the implementation of OHD

### Receiver-led Consolidation (Collaborative Logistics)

*This type of strategies seeks to foster behavioral changes within supply chains by taking advantage of the power of receivers to push for cargo consolidation.*<sup>18</sup> The objective of the strategy is to achieve a reduction in the number of deliveries. This could be achieved by

<sup>18</sup> Holguín-Veras, J., Sánchez-Díaz, I. Freight Demand Management and the Potential of Receiver-Led Consolidation programs. Transport. Res. Part A (2015), <http://dx.doi.org/10.1016/j.tra.2015.06.013>

reducing the number of suppliers or vendors, or by fostering the use of urban consolidation centers from the existing suppliers. The general benefits associated with this type of strategies include those to the receivers, suppliers, and the system. Receivers benefiting from having consolidated shipments, avoiding the need to deal with multiple vendors. In some cases, they can achieve economic benefits by being able to negotiate preferential or volume rates. Suppliers and carriers can increase productivity, with the negative consequence that some suppliers will be replaced. The overall reduction in deliveries, will translate in reduced freight traffic and the associated consequences.

The first case have been successfully implemented through the implementation of Delivery Servicing Plans (DSP).<sup>19</sup> The idea behind DSP, developed by Transport for London, is that commercial establishments in large buildings or large traffic generators, or large corporations with decentralized procurement practices conduct trip generation assessments and identify potentials for consolidation. In London, regulation requires that new developments propose construction logistics plans and DSPs. However, these plans are not subsequently enforced, and landlords or managers may not have incentives to invest the resources required for their implementation. For an implementation in California, the public agencies could develop incentives schemes to foster the implementation of these types of plans. Successful implementations in large buildings have shown their potential to reduce the number of truck trips generated from 20% to 60%.<sup>20</sup> Considering that in large dense urban areas, there may exist large traffic generators which could represent a significant proportion of the total freight traffic and associated externalities, these plans could help improve the freight efficiency and performance<sup>21</sup>. Analyses of the potential for implementation of this type of strategies in New York City, showed that they could reduce truck traffic between 6.5% and 21%.

Public agencies should identify the types of regulations that could facilitate the development of these types of strategies, considering that the focus would be on the receiver of the cargo. Moreover, research is still needed to design programs that consider the characteristics and behaviors of the California freight system.

## International Gateways

The international trade economy is of high importance in California, especially due to the sheer volume of cargo handled in Southern California by the San Pedro Bay Ports. Approximately 60% of total west coast intermodal containers pass through the Port of Los Angeles and Long Beach, and the exceptionally busy international border crossings between California and Mexico.

With respect to the seaports, along with the benefits of handling more containers than any other port complex in North America come the logistical inefficiencies of waits in and around terminals, congestion at corridors feeding these gateways, and other issues introduced by

---

<sup>19</sup> Transport for London. (2013a). "Delivery Servicing Plans." Retrieved July 04, 2013, 2013, from [http://www.tfl.gov.uk/microsites/freight/delivery\\_servicing\\_plans.aspx](http://www.tfl.gov.uk/microsites/freight/delivery_servicing_plans.aspx).

<sup>20</sup> Transport for London. (2013c). "A Pilot Delivery Servicing Plan for TfL's Palestra Offices in Southwark: A Case Study." Retrieved July 12, 2013, 2013, from <http://www.tfl.gov.uk/microsites/freight/documents/20090921-DSP-Palestra-Case-Study.pdf>.

<sup>21</sup> Jaller, M., X. Wang, and J. Holguín-Veras (2015). Large Urban Freight Traffic Generators: Opportunities for City Logistics Initiatives. *Journal of Transport and Land Use (JTLU)*, 8.1, 1–17

labor-related factors. Myriad different types of inefficiencies within marine terminals can affect both the truck traffic and vessel operations at international gateways. For example, although non-recurrent, port downtimes can negatively affect the shipping companies that own delayed vessels. However, vessels are typically handled efficiently, and most of the inefficiencies exist in the transfer of containers from the terminal to drayman.

Port terminal inefficiencies can be exacerbated by the arrival of larger ships, coupled with the rapid increase in popularity of Vessel Sharing Alliances (VSAs). VSAs are a great example of collaborative logistics strategies, where a number of independent shipping lines consolidate to share assets and maximize the use of their resources. While larger ships and alliances are tremendously important improvements in efficiency for ocean carriers, they can pose additional logistical challenges for marine terminals. A large vessel discharging cargo from multiple ocean carriers can complicate terminal management, as each shipping line in an alliance may have its own terminal agreements, trucking contracts, dispatching agreements, railroad agreement and operations management. In some cases, once the containers are unloaded, all synergies disappear. These large vessels can also create cargo surges of more than 10,000 container moves per call. This is also coupled with VSAs having as many as six carriers in one vessel (with some other effects such as the scattering of containers across multiple terminals). The call surges can result in an increased number of container repositioning moves within the terminals before the boxes are delivered to a trucker, further increasing terminal congestion. When this process is repeated week after week, it can make the delivery of containers more complex, costly, and inefficient.

However, as VSAs are becoming the norm, and the great efficiencies and advantages of larger vessels are internalized into the supply chain, marine terminals and public port authorities are working effectively and efficiently in order to handle the increases in demand. Positive examples resulting from preparedness, planning and collaboration include the recent experiences from port calls of 15,000 and 18,000 TEU vessels. Within 10 days in December 2015, the Port of Los Angeles (POLA) AMPT terminal handled 2 of the largest vessels ever to call a port in the America's (15,000 + 18,000 TEU vessels); in February 2016, the Port of Long Beach (POLB) PCT terminal handled the Benjamin Franklin, a 18,000 TEU vessel as well. According to Port Authority officials, all 3 vessel calls were extremely well coordinated with all supply chain partners, including labor, and no congestion was experienced.

Given these challenges, it is important to develop strategies to foster collaboration between beneficial cargo owners, port terminals, the trucking and rail industry, equipment providers, and ancillary facilities such as warehouses and distribution centers. Although these would be private driven initiatives, public funding or incentives could be used to help support the development of collaborative relationships in strategic portions of the supply chain that could help maximize asset utilization. In addition, funds could be allocated to investigate and identify the success factors of the recent mega-ship handling experiences mega-ships. The following sections discuss some strategies that could be used to help mitigate some of the issues previously discussed and those in Part I.

## Development of a Chassis Pool of Pools Fully Integrated System (Collaborative Logistics)

Chassis management has become a major issue for the intermodal supply chain, both in terms of chassis availability and also levels of utilization across the supply chains. These issues primarily emerged after many ocean carriers' decided to no longer own and manage their own proprietary chassis fleets. Ironically, many of these new inefficiencies are the result of ocean carriers' move towards greater system efficiencies whereby they removed equipment ownership barriers and terminal specificity issues. These issues persisted in the intermodal system as a result of the lines' traditional chassis ownership and provision model. For purposes of this strategy, it is important to note that no matter who owns the equipment, chassis are critical to intermodalism, and it is impossible to move containers by truck on-road without them. As a result, being able to reduce the time and costs of chassis management by eliminating shortages or maintenance problems could improve system efficiency and become a commercial advantage in the services provided<sup>22</sup>.

To cope with shortages of chassis', and also general availability problems, the Pool of Pools (PoP) initiative was created. This private initiative is comprised by the Direct Chassis Link Pool (DCLP), Trac Pacific Southwest Pool (TPSP) and Flexi-Van Los Angeles Basin Pool (FLBP)<sup>23</sup>. The PoP have alleviated the problem by providing more than 81,500 chassis to be used interchangeably and a new configuration of suppliers. The ports of Los Angeles and Long Beach utilize 31,866 chassis daily representing 40% of the total fleet. The PoP have helped reduce costs in operating private fleets and has an interchangeable pool to be utilized among all stakeholders reducing flips<sup>24</sup>, decreasing times and fuel consumption, as well as generating a collaborative environment with stakeholders to share assets and information about their operations. However, the PoP experiences a number of issues including<sup>25</sup>:

- *"The number of chassis dwelling on terminal for greater than 60 days is almost 7,000 units. We need help in getting these units back into circulation."*
- *"The number of Out of Service chassis is still over 5,000. We need help in getting these units repaired and back into service."*
- *"Repositioning of chassis could be limited during this period, Pool of Pools will need each MTO to release surplus on-terminal chassis."*

These, among other issues, provide improvement opportunities for the PoP. Therefore, this strategy suggests:

***The Development of a Chassis-PoP fully integrated system that seeks to transition the current PoP to an information and management system that provides the adequate type, quantity and quality of chassis available, and offers simplified administrative and billing services.***

<sup>22</sup> [http://www.fmc.gov/assets/1/Page/PortForumReport\\_FINALwebAll.pdf](http://www.fmc.gov/assets/1/Page/PortForumReport_FINALwebAll.pdf)

<sup>23</sup> <http://www.morethanshipping.com/the-gray-chassis-pool-and-what-it-means-to-you/>

<sup>24</sup> "Need to transfer a container from the chassis it is resting upon to another chassis", NCFRP Report 20

<sup>25</sup> <http://www.pop-lalb.com>, accessed November 30th, 2015

An effective provision of chassis requires the optimal and reliable provision of “certified” equipment to truckers. To be successful in the long run, the strategy requires that the private and public sector work together to create a reliable information and management system that provides an adequate quantity of chassis in optimal conditions. The scheme of a “gray pool” requires fully interchangeable equipment, simplification of management and billing, good and regular maintenance and repair of assets, and the development of robust information systems which provide to participants in the supply chain data regarding equipment availability timely and accurately. Having this information about the incoming equipment could help determine the reconfiguration of chassis at terminals and at virtual and off-site yards, and improve level of service. In addition, the average street dwell time for chassis is 4.5 days, thus reducing dwell time will improve the availability of chassis<sup>26</sup>.

A report released by the Federal Maritime Commission (FMC) in July 2015<sup>27</sup>, contains an overview of discussions from different stakeholders about port congestion and supply chain issues. Participants agreed on the need of more “gray pools” to provide chassis interoperability. Gray pools are most effective when there aren’t rules or provisions limiting motor carriers from utilizing any particular chassis, or chassis provider, and motor carriers are able to pick the provider from the pool that best suits their requirements. This type of equipment intermodalism is possible only when facilitated by legal interchange agreements. In this regard, there is a Uniform Intermodal Interchange and Facilities Access Agreement (UIIA)<sup>28</sup> which is an industry contract between truckers and drayage companies and water and rail carriers and leasing companies that serves as a standard interchange agreement for equipment but is not applied for chassis. The PoP has instituted its own interchange standards to facilitate its pool.

The improved Chassis-PoP should combine both the collaboration of different leasing companies that share a common interchangeable agreement of equipment but competing in service and price, and the ability to improve the land operations at the port facilities within a separate off-terminal yard or yards. In general, it would help reduce the number of flips between trucks and chassis and reduce the times of repair and inspection. Flips and trips to deliver chassis that belong to one terminal or operator is an inefficiency of the current system. Moreover, it would help reduce truck turn times at marine terminals, increasing the number of turns per vehicle, reduce the number of movements per chassis, and the number of out of service chassis.

The new Chassis-PoP integrated system will also help to improve roadability in addition to relieving congestion and inefficiency. The Federal Motor Carrier Safety Administration (FMCSA)<sup>29</sup> requires chassis to be in optimal conditions before interchange, but truckers at marine terminals are inconvenienced if they are only told of the need to make repairs at the roadability gate after they have already received the chassis. The problem here occurs when

---

<sup>26</sup> Journal of Commerce (JOC) (2015), “Extended free time contributes to chassis shortages in LA- Long Beach”, October 1, [http://www.joc.com/port-news/us-ports/extended-free-time-contributes-chassis-shortages-la-long-beach\\_20151001.html](http://www.joc.com/port-news/us-ports/extended-free-time-contributes-chassis-shortages-la-long-beach_20151001.html), accessed October 2015

<sup>27</sup> U.S. Container Port Congestion and Related International Supply Chain Issues: Causes, Consequences and Challenges, 2015

<sup>28</sup> <http://www.uiia.org/about/index.php>

<sup>29</sup> <https://www.fmcsa.dot.gov>

roadability inspections are performed after the chassis is provided to the trucker. There's no inbound chassis interchange inspection, because truckers must report chassis conditions or problems when they drop the equipment as required by the FMCSA, but most do not. Without these required reports being filed, no quality assurance system exists to ensure that chassis provided are in good conditions until it is provided to the next trucker. Most chassis are repaired only if a trucker decides to take it to the roadability gate which impacts their hours of service, because they have to wait for them to be ready. Under this strategy, because roadability will be improved, it will stop the inefficiencies that result from a chassis in bad condition just going back into the pool and being directed to another trucker which will have to face the same problems and delay.

The POLA/POLB C-PoP is currently developing and implementing management systems to improve operations. Also, the FMC sanctioned POLA/POLB "Supply Chain Optimization" effort is working with the C-PoP to explore system improvements, including possible integration with other intermodal logistics management systems such as: eModal and the USDOT's FRATIS project, currently in the demonstration phase. The POLA/POLB are also working with LA METRO and CARB for incorporation of the aforementioned systems and "connected vehicle systems" into the proposed State's CARB Sustainable Freight Action Plan (SFAC) Pilot Project, being considered for funding.

As demonstrated by the current efforts, the successful implementation of this strategy and expansion to other ports would require collaboration between various stakeholders. Moreover, the effectiveness of the system to maximize asset utilization requires integration with other management and information systems, within the marine terminals, and participating stakeholders. Public agencies support for pilot testing will be crucial in the development and evaluation of such integrated systems.

### **Improvement of Traffic Mitigation Fee Programs (Demand Management)**

The Traffic Mitigation Fee (TMF) Program, *PierPass*, has been a success in the San Pedro Bay ports. This program fosters freight operations in the off-hours. Since 2005, as a result of severe congestion, the Off Peak program has been in place and a TMF has been charged to container movements during the day shifts to pay for the nighttime shifts. The program handles 17,000 truck trips on average per night during the 6 pm to 3 am shift; this represents around 55% of the daily truck trips<sup>30,31</sup>. In 2015, the Port of Oakland announced that its marine terminals are considering the implementation of a similar Off peak program called OakPass.

According to a public report, while many carriers express willingness to move their operations to nighttime deliveries, there doesn't appear to be a corresponding response on the side of the businesses to operate during off-peak nighttime hours<sup>32</sup>. During the interviews conducted as part of this paper, it was identified that about one third of the warehouses in the SCAG region operate in the off-hours mainly because they are part of the PierPass program. By performing

---

<sup>30</sup> PierPASS (2015), "OffPeak Information", <http://www.pierpass.org/offpeak-information/>, accessed October 2015

<sup>31</sup> [http://www.pierpass.org/wp-content/uploads/2015/07/2014-Operational-Costs-and-Financial-Report\\_Final.pdf](http://www.pierpass.org/wp-content/uploads/2015/07/2014-Operational-Costs-and-Financial-Report_Final.pdf)

<sup>32</sup> The Tioga Group, Inc. – Dowling Associates, Inc. (2008). Truck parking facility feasibility and location study.

Available from:

[http://www.alamedactc.org/files/managed/Document/10635/Truck\\_Parking\\_Facility\\_Feasibility\\_and\\_Location\\_Study.pdf](http://www.alamedactc.org/files/managed/Document/10635/Truck_Parking_Facility_Feasibility_and_Location_Study.pdf).

operations during these times, the program is able to improve operations related to: time spent waiting between dispatches, time spent waiting to enter the terminal, and time spent inside the terminal either picking up or dropping off a load. Moreover, reduced truck traffic during the peak hours improves operations to all users in the network. Considering that about 95% of all the truck trips to/from the POLA/POLB are to/from container terminals, any reduction in the number of trips during the daytime would have a significant environmental and traffic impact.

Despite the initial success of PierPass, there are current issues affecting its performance which could be optimized. The first issue has to deal with the perception of truck drivers about the direct benefits of operating at the night times. Due to claims of insufficient demand to meet the increased costs of operating in the off-hours, a number of port terminals have reduced the number of night (and weekend) shifts provided (only 4-5 terminals). In some cases, this reduction of shifts have resulted in perceived diminishing benefits from customers during these time periods. The reduction in direct benefits coupled with an increase in the TMF of \$69.15 per TEU, have prompted criticism to the program. Efforts have been invested by the terminal operators to explain and support the fee increases<sup>33,34</sup>.

In addition, due to the fixed and static format of the program, queues form outside terminals before the night shifts (by the number of drivers that want to take advantage of the differential pricing). Therefore, with the improvement of PierPass it is also important to improve the efficiency of truck dwell times and validations processes. According to PierPASS, usual truck turn times are at about 60-70 minutes average, 40 minutes for a pick-up transaction and 20-30 for a drop-off. But if some information about the truck is not fully supported by documentation, online appointment validation or any other issue that could raise, truckers are required to go to the trouble ticket windows which can take on average 1 hour (but could be much longer). As part of the Supply Chain Optimization (SCO) effort, the POLA/POLB are working with the Metropolitan Transportation Organization and other supply partners to explore modifications/ improvements to the PierPass system, including better measuring of turn times and appointment systems. Regarding turn times, the POLA/POLB are considering partnering with a new system soon to be launched by the Harbor Trucking Association, which utilizes a smart phone/tablet application to constantly track trucks, and produce turn times. Additionally the POLA/POLB is considering incorporating this system, into the aforementioned CARB SFAC Pilot Project.

In general, the program has provided benefits to the system, and has shown the success of implementing a Traffic Mitigation Fee that is charged to cargo owners instead to the truckers (as it is typical in other pricing or charging schemes). Therefore, the strategy put forward here, **seeks to improve the TMF Program**. This could be accomplished by:

- Addressing inefficiencies within the marine terminal to increase the benefits experienced by the Program users. Inefficiencies in marine terminals exist regardless of the time period, therefore, to increase the benefits from the Program, the root cause of these inefficiencies must be addressed.

---

<sup>33</sup> Rule 7 of the WCMTOA Schedule reads: "...the Fee shall be adjusted annually to reflect increases in labor costs based on Pacific Maritime Association maritime labor cost figures." The approximate 3.5% increase in the TMF reflects this fee. It is part of ongoing rate increases applied per this Rule.

<sup>34</sup> [http://www.pierpass.org/wp-content/uploads/2015/11/PierPass-Financial-Overview\\_10-21-2015.pdf](http://www.pierpass.org/wp-content/uploads/2015/11/PierPass-Financial-Overview_10-21-2015.pdf)



When looking at system level improvements, terminal operators are best positioned to engineer solutions. Ports can help to foster terminal optimization and best practices, but non-operating ports cannot develop and implement a program. As part of the SCO effort, the POLA/POLB is exploring “push (as opposed to pull) terminal logistics IT systems to convey containers to/from drayman.

- Revising the current pricing scheme. A more dynamic congestion management pricing scheme may prove more optimal at reducing congestion and improving efficiencies during both the day and off-peak hours. These charges could be lower during periods of lower utilization during the day and some minimal charges could be instituted for periods of high demand and utilization during off-peak. Although a fully dynamic pricing scheme would optimize the port (terminal) utilization, it could create confusion among the various stakeholders. An alternative would be to identify block/segments of time, and charge them differently. The development of an appropriate pricing scheme requires additional research.
- Normalize the multiple existing industry performance and efficiency indicators in order to measure improvements or degradations of off-peak programs.
- Implementing appointment/reservation systems. The TMF Program could also be combined with the implementation of appointment and reservation systems.

Implementation of these strategic changes would reduce turn times of trucks and improve terminal efficiency. This in turn, would help reduce congestion, truck waiting times at the queues, and increase throughput. Some of the changes described below could be addressed in the short-term, though careful planning and research about optimal program design could require additional time and funding support. Public agencies could provide the funding and planning support for the development of the improved program, and at the same time, work with Port Authorities, terminals and other stakeholders to identify additional opportunities for perceived benefits. If a dynamic system is found to be the optimal pricing scheme, a data collection and information dissemination framework and system must be developed. This could require investment and planning beyond the marine terminals, thus requiring a higher level of coordination, planning and funding.

To be successful, there is a need for some specific common metrics to measure the turn time. As with the current system, queues outside the terminal constitute a potential unintended consequence. The ability of the system, the incentives/penalties, and the implementation of the reservations system could alleviate those issues. One important aspect to be considered when designing the pricing scheme is how this FDM strategy will affect the corridors and locations surrounding the marine terminals. Research to investigate such potential outcomes is recommended.

### **Implement Advanced Appointment/ Reservation Systems (Demand Management)**

It is clear that trucking is often characterized as the most irregular and unpredictable mode of transport in port-related operations. In a study on truck announcement times, van Asperen et al. notes that “...if we consider the different transport modes a container terminal has to deal with, then road transport by truck is the least coordinated”<sup>35</sup>. Despite a lack of coordination between trucking companies and other parts in the intermodal machine, general research results have shown that total number of truck arrivals tend to follow certain patterns. While a

---

<sup>35</sup> van Asperen, Eelco, Bram Borgman, and Rommert Dekker. “Evaluating Impact of Truck Announcements on Container Stacking Efficiency.” Springer. 19 Oct 2015. Web. 23 July 2011.

specific truck may not be predictable, truck arrival numbers have been shown to peak during certain hour windows within a day. This inefficient characteristic lends itself well to being addressed by truck scheduling strategies.

Consequently, the strategy put forward here ***seeks to develop and implement and advanced appointment and reservation flexible system that integrates with other information systems to maximize asset utilizations***. However, developing such a system requires the analyses of various operational aspects and potential consequences resulting from the system's implementation and the research about the effectiveness of appointment systems is not conclusive.

Many studies have chosen to use truck line (or queue) lengths and/or truck turn-around (or waiting) times as measurements of efficiency. Reducing line lengths and overall wait time lessens or erases the physical representation of truck traffic outside of ports, hence addressing the most visible problem with container-movement inefficiency. Appointment windows have been a popular solution, underlining the ultimate goal of evening out truck appointments over the day in order to take advantage of less busy time periods and avoid peak demand. Current trends indicate that trucks will be required to schedule appointments in 10 out of the 13 container terminals in the San Pedro Bay by the end of next year<sup>36</sup>.

In a Marseilles study<sup>37</sup>, authors attribute the success of their truck appointment system (TAS) to the fact that the system was well thought-out and thorough, rather than myopic. The authors of the study note that previous studies have failed to include all of the pieces of a system that need to be considered in order to effectively implement a scheduling strategy. In their study, they focused on the supply-demand relationship between truck or vessel arrivals and cargo-handling equipment availability at time of arrival. This could be evaluated for application in California ports.

According to a report that analyzed initial appointment systems implemented in some terminals in California indicated that "...the estimates of potential turn time savings from appointments suggests that a large proportion of trips would have to use appointments, and appointment trips would have to be given some priority to realize significant time savings. It is only under these conditions that an appointment system would reduce truck queuing enough to result in lower truck emissions..."<sup>38</sup>

Other studies have shown no impact or have even shown a negative result. In contrast with the success seen at Marseilles, Le-Griffin et al.<sup>39</sup> concluded that addressing truck congestion by

---

<sup>36</sup> <http://www.polb.com/news/displaynews.asp?NewsID=1491>, accessed October 2015

<sup>37</sup> Zehendner, Elisabeth and Dominique Feillet. "Benefits of a truck appointment system on the service quality of inland transport modes at a multimodal container terminal". *European Journal of Operational Research*. 19 Oct 2015. Web. 15 July 2013.

<sup>38</sup> Giuliano, G., & O'Brien, T. (2007). Reducing port-related truck emissions: The terminal gate appointment system at the Ports of Los Angeles and Long Beach. *Transportation Research Part D: Transport and Environment*, 12(7), 460-473.

<sup>39</sup> Le-Griffin, Hahn D., Lam Mai, and Mark Griffin. "Impact of container chassis management practices in the United States on terminal operational efficiency: An operations and mitigation policy analysis." *Research in Transportation Economics*. 19 Oct 2015. Web. 20 July 2011.

making appointments to let trucks through terminal entrance gates more quickly simply shifted the inefficiency of the system from outside of the gate to inside of the gate. Unintended consequences must be considered. This demonstrates that taking away the most visible representation of a problem, such as trucks, does not necessarily mean that that problem has been fixed, or that another problem has not been created.

Historically, truck appointment systems have not been as appealing to terminals because truck queues were more of a burden to trucking companies waiting in line than they were for terminal operators serving those lines. In addition, it is claimed that by setting appointments inefficiencies are introduced as they are associated with a fixed number of transactions in a day. However, as demonstrated by the Marseilles study, some research in recent years has begun to highlight the importance of considering the interconnection of all modes operating both in and out of a terminal. The value in coordination is starting to be more strongly recognized

As trucking appointment systems have been evaluated in many studies around the globe, investigating their feasibility in reducing congestion and improving efficiency in California ports would be wise. Developing such system requires an integrated effort between the public and private sector. It is important to identify the root causes for the irregular and unpredictable operations both in and out of the marine terminals. This would allow defining the rules and logics of the flexible system, and defining the appropriate time windows considering the uncertainties about the exact transaction times. Due to the mixed results reported in the literature, appointment systems should not be implemented lightly, rather they should be the result of significant research and planning efforts. The public authorities should provide the support (funding, access to information, stakeholder engagement) needed for those activities. One important aspect that would require careful attention is how to deal with the penalties and enforcement of appointments and reservations. Similarly as with the other strategies, the appointment system should be integrated with the other management systems put in place by some of the system stakeholders.

Nevertheless, it is expected that an appointment system (granted that terminal operations are optimized) would help mitigate some of the inefficiencies currently observed. The appointment system needs to be flexible enough to handle the operational needs when implementing strategies ranging from push systems, to peel-off and free-flow.

As mentioned before, as part of the SCO effort, the POLA/POLB is working with the MTO and other supply partners to explore modifications/improvements to the PierPass system, including appointment systems. An existing intermodal logistics system, eModal, which has been in existence and used by trucking companies, terminal operators, customs brokers, 3PL, etc., since 2002, provides appointment systems for several of the POLA/POLB terminals already. Emodal will be expanding their appointment systems to more terminals in 2016. The POLA/POLB is working with eModal and the terminal operators to have a universal and uniform system in place in the near future. Additionally, the POLA/POLB is considering incorporating this system into the aforementioned CARB SFAC Pilot Project.

## Developing an Integrated System for Dray Operations and Services (Collaborative Logistics)

***This strategy seeks to foster the development of cooperation and collaborative agreements between drayage operators, beneficial cargo owners, and in some cases, shipping lines and port terminals, to offer a shared service*** that can facilitate practices such as “free flow” or “peel off.” The main objective would be to optimize container flow in Port Terminals. A dray agreement does not necessarily involve the provision of a pool of vehicles, but it would require the implementation of information systems that allow, among other things, container visibility to entire supply chains, real time traffic data, roads and terminal turn time and queues.

In addition, a strategy like this could help with new port paradigms such as push systems. As the name indicates, in push systems, containers are “pushed” out of the terminal instead of being pulled by beneficial cargo owners at their discretion. This in essence would help reduce cost, increase container velocity and truck turns, improve reliability and predictability, and improve labor and equipment deployment.

These new practices, push systems, peel-off, dray-off, and free flow are similar in the sense that they try to move boxes out of the terminal more efficiently. However they may impose additional challenges to individual operators, especially drayage companies that have contracts with specific clients. Push systems and peel-off type of systems could be implemented together, as push could be implemented for all sized shippers, and peel-off for large beneficial cargo owners. The success of these strategies heavily depends on the fluidity of the system which is affected upon inland facility operations and capacity<sup>40</sup>.

The creation of the Dray system, would work similarly as the peel-off/dray-off cost model, but extended to the integrated operations with other stakeholders in the supply chain. Peel-off/dray-off models generally assume that the control and ownership of each box from ship to door is all managed by a single agency that minimizes overall costs. In general, the model estimates total terminal and drayage costs based on unit capital and operating costs and typical productivity factors

The public sector, as in the case of the Chassis-PoP, should foster a competitive and collaborative environment. Moreover, investments would be needed to develop the integrated information system that should be compatible with solutions such as the California Freight Advance Traffic Information System (FRATIS), and other commercial systems. A pilot test at the Port of Los Angeles showed that using a commercial (online and app-based brokerage) system and a free flow strategy could increase productivity by 500% (250 container deliveries per shift vs. 50) and reduce the average driver turn times in half (42 mins vs. 85 mins).<sup>41</sup>

An important aspect of a strategy like this would be the need for the implementation of incentives or the creation of an appointment system that is capable of handling the different

---

<sup>40</sup> Davies, P. and M. Kieran (2015). Port Congestion and Drayage Efficiency. Presentation at the 2015 INUF Metrans Conference. Long Beach, CA.

<sup>41</sup> Harman, D. (2016) On-demand Load Matching for Trucks. Presentation at the 2016 TRB Annual Conference Urban Freight Workshop on On-Demand Technology and Sharing Economy for Freight. Washington, D.C. January 10<sup>th</sup>.

requirements of port related activities, depending on the type of operational strategy in place. Moreover, this types of systems that rely on information sharing and technologies need to be developed considering data access and custodial, as well as the framework for their management. While the public sector could not mandate the collaboration between dray operators and services, it could provide the support for the analysis and research of effective incentive programs that foster participation and a behavioral change.

As part of the SCO effort, the POLA/POLB is exploring “push” (as opposed to pull) terminal logistics IT systems to convey containers to/from drayman.

### **Load Matching and Maximizing Capacity (Collaborative Logistics)**

As cargo rates are increasing, ports are facing challenges to meet demand. Scheduling arrival of ships and aligning other elements in the supply chain to achieve a good level of service requires information systems and collaboration among stakeholders. One of the by-products of an effective and globalized containerized cargo is the ability of the system to keep a healthy number of “empties” in the system and available for shippers. The number of empties also reflects the relative balance of trade between nations, which is a function of the international economy and factors out of the control of any one seaport. As a result of the United States’ current imbalance of trade, for instance, in 2015 at the Ports of Los Angeles, while empties accounted for only 2.8% of imported containers they accounted for 57.3% of all exported containers (2.2 million TEUs).<sup>42</sup> The transportation of these empty containers, primarily back to the terminal for export, require transportation services to and from facilities after use, but these are repositioning moves which are not revenue-generating, and although needed, the transport of empty containers can add to total system inefficiency. Some of the causes of empty container inefficiencies arise from size and type of equipment, lack of visibility and collaboration within stakeholders as well as information systems to track containers<sup>43</sup>.

To remediate this issue, **Load Matching Strategies** could provide key benefits. The objective of load matching strategies is to reduce VMT associated with empty trips. There are many variations of load matching; examples include matching empty containers with loads; first come, first take pickups; and platforms to match small loads with available space in containers which are not already full.

These types of strategies have been implemented with some success in various regions of the country. For empties, empirical evidence indicates that it is possible to match between 20-30% of the trips. However, the main limitation in most cases is the positioning cost, or the cost to transport the empty container between its location and the location of the cargo. Although, analyses are still needed, these costs could be in the order of \$200-\$300 per movement.<sup>44</sup> Therefore, the public sector could develop an incentive program to increase the likelihood of matching and thus contribute to reduce the number of empty trips in the system. Considering

---

<sup>42</sup> [https://www.portoflosangeles.org/Stats/stats\\_2015.html](https://www.portoflosangeles.org/Stats/stats_2015.html)

<sup>43</sup> Lee, Meng, ed., Handbook of Ocean Container Transport Logistics: Making Global Supply Chains Effective, Switzerland, Springer, 2015

<sup>44</sup> Turman, R. (2015) Southeast Streamline. Developers of load-matching system for importers and exporters on the East Coast. Coalition of Responsible Transportation. Personal communication.

the higher numbers of empties compared to loaded outbound shipments, the potential benefits of fostering these types of strategies is high.

Other examples involve the development and use of information technologies to facilitate traditional freight services such as freight brokerage. These types of technology platforms allow participation from carriers, manufacturers and distributors, freight forwarders, 3PLs, brokers, or businesses that regularly or sporadically have freight needs. One of the key factors that benefits from these technologies is the ability to provide information about unused capacity, asset visibility and reduction of “dead head” miles or empties. These systems could help reduce some of the inefficiencies at the long haul (city to city) transport, short-haul, last mile, international, and even at the courier express services. Complementary strategies have also been developed to help mitigate some of the problems associated with “empties” at the warehousing level. Figure 3 shows examples of these systems<sup>45</sup>.

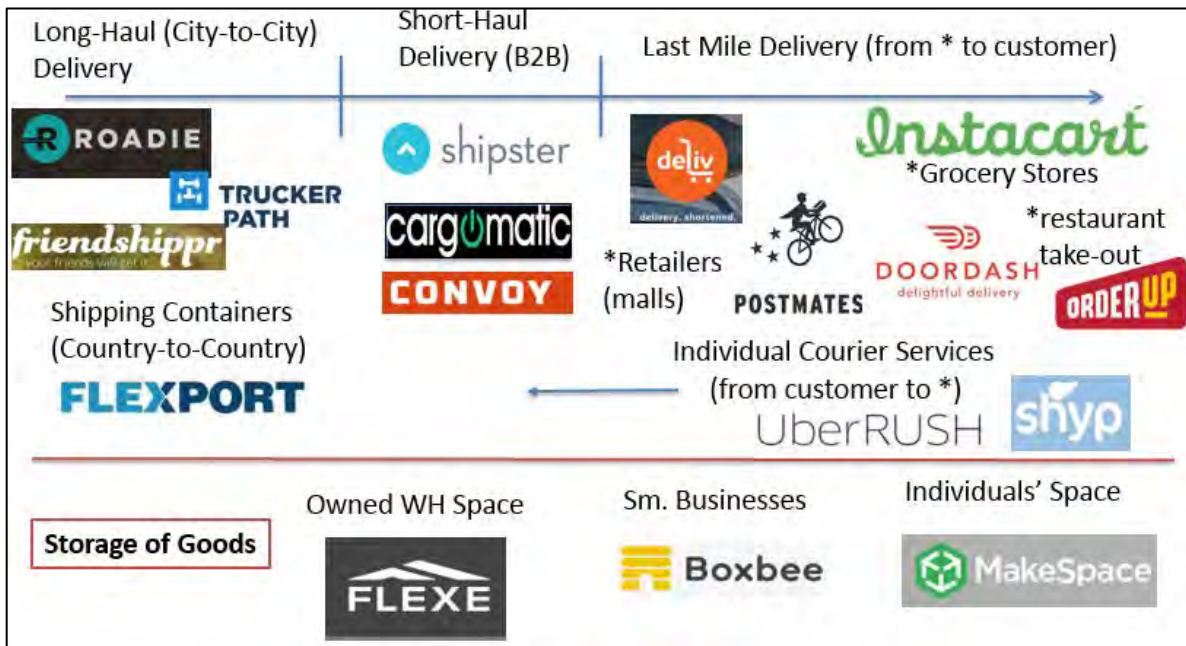

Figure 3: Examples of On-Demand Logistics Platforms

Although some of the examples in Figure 3 are new technological platforms for traditional freight services, current on-demand technologies and sharing practices have resulted in new freight operations and behaviors. Public agencies should support the planning and research for the potential applications of such services. However, it is clear that technology and information systems could play a key role in maximizing asset utilization. Public sector agencies should also identify the adequate allocation of resources such that these planning and research efforts are conducive to an efficient system and do not interfere with private business models.

<sup>45</sup> Pazour, J. (2016). The On-Demand Economy and Urban Freight. Presentation at the 95<sup>th</sup> Transportation Research Board Annual Meeting, Washington, D.C.

The Ports of Los Angeles and Long Beach are exploring a Virtual Container Yard (VCY) as part of their Supply Chain Optimization effort (SCO). The Ports have been in discussion with a private entity which will soon be launching a VCY service. The Ports and SCO participants will continue to promote such a service, and others that might emerge. However, the Ports will not actually deploy its own VCY to supplant or supplement other VCY services.

## All Layers of the Economy

The previous strategies have concentrated in freight demand management and collaborative logistics; however, traffic management in the form of relaxing vehicle size and weight restrictions could have the potential to contribute to maximizing asset utilization. This strategy could affect the distribution economy as well as the freight corridors in the international gateways.

### Relaxing Vehicle Size and Weight Restrictions (Traffic Management)

This final strategy, does not specifically relate to demand management or collaborative logistics; however, due to its importance to alleviate some pressing issues (investment in rail infrastructure, driver shortages, and freight traffic) it is discussed here.

***Allowing increases in truck length and size would provide the opportunity for significant gains in efficiency for certain portions of the freight industry.*** Heavier GVW maximums and longer trailer configurations, e.g., 97,000 lb weight limits or use of 2-3 trailer long combination vehicles (LCVs), could provide benefits in multiple different forms. In terms of expected benefits, examples of metrics measures used in some studies looking at the US system include reduced number of trips, reduced administrative costs, less congestion, fewer hours of idling, less demand for drivers, reduced total fuel usage, and lower total emissions.

Truck weight and size limits in the US have not been changed since the 1982, when the Surface Transportation Assistance Act (STAA) mandated an 80,000 lb federal weight (GVW) limit for interstate highways. This is exacerbated by the continued existence of a previous prohibition [from 53 years before 2009] that requires that, in order to increase their size or weight limits on sections of the interstate highway within their borders, individual states must demonstrate a grandfathered right (from before 1956) to do so. Additionally, in 1991 ISTEA froze the weights, lengths, and routes of operation of long combination vehicles (LCVs). It is clear that vehicle size and weight restrictions is a complex issue.

A few different opportunities exist where truck weight and/or size increases would provide easily achievable efficiency benefits. “It is generally accepted that in the U.S. the ratio of mass-limited to volume-limited semitrailers ranges from about 50/50<sup>46</sup> to 40/60<sup>47</sup>. According to a survey of the NPTC, 86 percent of companies experience some weight out, 76 percent experience some cube out, and 66 percent have both weigh outs and cube outs. A more in-

---

<sup>46</sup> NRC [National Research Council] (2010). Technologies and Approaches to Reducing the Fuel Consumption of Medium- and Heavy-Duty Vehicles. Available at: [http://www.nap.edu/catalog.php?record\\_id=12845](http://www.nap.edu/catalog.php?record_id=12845)

<sup>47</sup> Woodrooffe, J. (2014). Reducing truck fuel use and emissions: tires, aerodynamics, engine efficiency, and size and weight regulations.

<http://deepblue.lib.umich.edu/bitstream/handle/2027.42/109749/103144.pdf?sequence=1&isAllowed=y>

depth survey found that fifty-six percent of companies' shipments regularly weight out, and 34 percent regularly cube out. Any situation that involves a weight out can be equated with an opportunity for heavier weight allowances to have an impact on efficiencies. Similarly, any situation involving a cube out represents an opportunity for trailer size/length increases such as the use of LCVs.

In the bright side, companies estimated that they could see a 10% reduction in truck trips if weight restrictions were increased, and a 6 percent reduction in trips if LCVs were allowed. For 5 companies that could benefit from weight restriction increases, an increase of 8,000 lbs in GVW allowance would save 7.5 million gallons of fuel, and an increase of 14,000 lbs would save 10.8 million gallons. Use of LCVs are estimated to achieve a 34.9% reduction in fuel usage, on average. "Of the three scenarios evaluated, the LCV option has the greatest projected influence on fuel consumption and emissions reduction"<sup>48</sup>. Looking at the scenarios, combined, can provide even more benefits. Assuming all companies in the study are representative of the general truck population in the US (an issue the authors acknowledged was an unknown), if both a 8,000 lb increase and use of twin 53-ft trailer LCVs were allowed, national annual diesel fuel usage would decrease by 2.6 billion gallons. If a 14,000 lb increase and LCVs were used, that reduction would be nearly 3 billion gallons.

Investigating the potential for longer and/or heavier trucks in California would provide a significant prospect to address goals specified by the Governor's Executive Order. Compared to other countries that already have looser restrictions on size and weight, the US has a large opportunity to increase their efficiency and have a more competitive freight system. "The potential gains in freight efficiency for freight that could make use of vehicle weight increases matching our NAFTA partners Canada and Mexico are 44 and 53 percent, respectively"<sup>49</sup>. Large increases in efficiency that could be achieved by adjustments to the federal weight and size limits could provide efficiency gains that could possibly meet or exceed the Governor's goal. It is important to consider, however, several factors that can have large effects on estimated results<sup>50</sup>:

- Each company has different areas where efficiency gains can be achieved through the expansion of size and weight limits; not all companies would benefit from each possible loosening in regulation;
- "Larger trucks, including LCVs, will not be suitable for all roads, and route selection, permitting and monitoring will be important issues";
- There could be increased wear-and-tear on the trucks, tires, and trailers, affecting the lifetimes of the equipment;

---

<sup>48</sup> Woodrooffe, J., Belzowski, B. M., Reece, J., & Sweatman, P. (2009). Analysis of the potential benefits of larger trucks for US businesses operating private fleets.

<http://deepblue.lib.umich.edu/bitstream/handle/2027.42/65000/102510.pdf?sequence=1&isAllowed=y>

<sup>49</sup> Woodrooffe, J. (2014). Reducing truck fuel use and emissions: tires, aerodynamics, engine efficiency, and size and weight regulations.

<http://deepblue.lib.umich.edu/bitstream/handle/2027.42/109749/103144.pdf?sequence=1&isAllowed=y>

<sup>50</sup> Woodrooffe, J., Belzowski, B. M., Reece, J., & Sweatman, P. (2009). Analysis of the potential benefits of larger trucks for US businesses operating private fleets.

<http://deepblue.lib.umich.edu/bitstream/handle/2027.42/65000/102510.pdf?sequence=1&isAllowed=y>



- Weight increases would be compatible with most existing infrastructure, but bridge weight restrictions need to be considered in addition to interstate highway restrictions;
- Heavier trailers that only have 2 axles will need a third axle in order to handle more weight. This raises cost concerns and issues surrounding who owns the trailer/would be responsible for retrofits/turnover in the trailer fleet. Estimating retrofit costs would be very difficult, considering the large variety of equipment/uses;
- LCV use has limitations largely based on infrastructure-related geometric constraints;
  - LCVs will likely require special government permitting and additional training for drivers; they also would require significant infrastructure changes in different areas of use, including on roads and also at the point of transition from interstate to urban area (e.g. needing drop yards); operational adjustments, on the side of the companies, would be needed as well;
- The use of for-hire carriers, versus private carriers, can have an impact on the feasibility (and cost burden) of weight increases and LCV use.

Additionally, impacts on California's roadways and pavements need to be considered. The Transportation Institute at Texas A&M has conducted research in this general area, and their findings should be looked at and considered when looking at the potential of heavier trucks in California. Although a complex topic, the potential for improvements due to modifying size and weights restrictions warrants the need for additional research to identify those locations or corridors where they could be implemented. Federal and State Agencies should take the lead on identifying those opportunities. Concerns about infrastructure damage, safety, and other issues are valid reasons to invest resources to identify the feasibility of such strategies. However, technical feasibility may not equate with regulatory constraints.

## Summary of Strategies

In general, the discussions for each strategy showed that there is variability in the potential for their impacts, the levels of effort needed for their implementation, and the type of stakeholders involved in the planning, research, and implementation phases. Some of the strategies are likely to be widely understood by the practitioner community, while others require careful analysis and implementation to avoid unintended consequences. Moreover, the amount of public information available about experiences and assessments, varies from strategy to strategy; this is especially the case for the required level of costs and implementation efforts. This section summarizes the various proposed strategies based on a qualitative assessment of some of the factors discussed in Section I: potential benefits; stakeholders' role in the implementation/planning effort; requirements; and the opportunities for the implementation of new technologies. The qualitative assessment is based on the discussion and critical analysis of each strategy. For each factor, a 3-level scale is used, indicating low, medium and high relationship (i.e., positive effect, level of involvement, and level of effort/investment). Lack of an assessment indicates that the criterion does not apply to the strategy, or that the relationship is very low. In general the assessment is made considering that the strategy is feasible for implementation, and that the unintended consequences have been addressed. This assessment should be used as a general guideline, and for comparison

purposes between the strategies. The assessment does not imply the real magnitude of the effects as it will depend on the specifics of the program to be implemented.

For example,

Table 4 shows the potential benefits expected from the implementation of each of the strategies. The assessment clearly indicates that these strategies have the potential to generate positive effects in terms of increased operational efficiency, reduced congestion, and improved environmental sustainability; while not generating major impacts on safety, security and enhancing livability. However, the magnitude of those benefits could not be estimated, as additional research, simulation, modeling and analyses are required to identify the corridors, and/or specific locations (or stakeholders) where those benefits would be realized. For example, while some of the benefits could be perceived inside maritime terminals, other benefits such as reduced congestion could impact all network users (thus quantifying them is a complex task). For the cases for which information is available, overall emission reductions could be in the order of 4% as in the case of Off-Hour Deliveries. Another important aspect that limits the ability to quantify the benefits is the fact that, in most cases, the implementation of various strategies does not have an additive effect. Though, controlling for unintended consequences such as induced demand, it is expected that the benefit would be a compounded positive effect.

Table 4: Potential Benefits

Potential Benefit Strategy	Increase Operational Efficiency	Reduce Congestion	Environmental Sustainability	Enhance Safety	Enhance Security	Enhance Economic Competitiveness	Public Sector Revenue Generation	Enhance Livability
Chassis-PoP	+++	++	+			++		
Integrated Dray Services	++	+++	+++	+		++		
Advanced Appointment/Reservation Systems	+	+	++	+	+	+	+	+
Load Matching/Maximizing Capacity	++	++	++			+++		+
Improving Traffic Mitigation Fee Programs	++	++	++	+		+	+	+
Relaxing Vehicle Size and Weight Restrictions	+++	+	+			++	+	
Receiver-led Consolidation	+++	+++	++			++		+
Voluntary Off-Hour Delivery Programs	+++	++	++	+		++		++

(+) denotes a low positive effect. (++) denotes a moderate positive effect. (+++) denotes a high positive effect

When designing the various strategies and conducting the planning efforts, it is important to identify the stakeholders' role in the process (see

Table 5). For the purpose of this paper, when referring to the local/regional/State/Federal government, planning agencies, and other public authorities' involvement, the analyses refer to the level of engagement required from each of those stakeholders to provide critical external planning, financial, or policy support. A clear difference should be made between the stakeholder engagement for the design, planning and implementation process, and the specific stakeholders targeted by the strategy. For example, while receiver-led consolidation primarily targets shippers and receivers of the cargo, other stakeholders such as logistics operators and ancillary facilities would need to coordinate the changes in operational patterns; governmental involvement requirements may be limited. Voluntary off-hour delivery programs exhibit similar characteristics in terms of the targeted stakeholders; however, the implementation and planning efforts require engagement from many other stakeholders including, local, regional and national public agencies.

In other cases, the planning effort should consider issues resulting from the improvement of operations of specific modes. For examples, relaxing truck size and vehicle restrictions may induce an undesirable mode shift from rail to truck; moreover, the infrastructure investments to facilitate the traffic of heavier vehicles may create equity differences between the publicly and privately owned infrastructures (e.g., rail). In this specific example, relaxing vehicle size and weight restrictions for over the road vehicles, could generate opposition from the rail industry, and communities.

Table 5: Stakeholders’ role in the implementation/planning effort

Stakeholder	Shippers	Carriers - Road (Drayage /Distribution)	Carriers - Rail	Carriers - Maritime (Shipping Lines)	Receivers (Large and Small Establishments)	Port Terminals	Warehouses/ Distribution Centers	Logistics Operators	Local Government/ Planning / Authorities	State / Regional	Federal	Others (Trade organizations, scientists, academia, communities)
Strategy												
Chassis-PoP	+	+++	+	++		+++		+++	+	+++	+	+
Integrated Dray Services	++	+++	++	++	+	+++	++	+++	++	+++	+++	++
Advanced Appointment/ Reservation Systems	+	+++	++	+++	+++	+++	+++	+++	+	+		+
Load Matching/ Maximizing Capacity	+++	+++	++	++	++		+++	+++		+	+	+
Improving Traffic Mitigation Fee Programs		++		+++	+++	+++	+	+	+++	+	+	+
Relaxing Vehicle Size and Weight Restrictions	+	+++	+		+	+	++	+	+	+	+++	+++
Receiver-led Consolidation	++	+++			+++		+++	+++	+	+	+	+++
Voluntary Off-Hour Delivery Programs	++	+++			+++		+++	+++	+++	++	++	+++

(+) denotes a low involvement. (++) denotes a moderate involvement. (+++) denotes a high involvement

Each stakeholder could participate in the implementation and planning efforts in many forms. However, the type of requirements to develop a sound strategy could be categorized in: cooperation and coordination efforts; need for incentives or taxation; the need for funding or capital investment; development of information technologies; development of new

technologies such as hardware, equipment; infrastructure improvements; and regulatory framework. In essence, the requirements could be in terms of technological, financial, planning, policy or operational support. Table 6 summarizes the type/level of requirements expected for each strategy. The assessment shows that cooperation and coordination, development of incentives and taxation schemes, and the development or use of information technologies are the primary requirements for these strategies. Designing each strategy should try to guarantee participation from the targeted stakeholders. Examples include the off-hour delivery program and the use of incentives to foster participation; or the recent experiences with the SCO at the POLA/LB, where a number of stakeholders are cooperating and considering optimizing strategies. The cooperation and coordination among the stakeholders have resulted in successful stories such as the handling of the 3 largest vessels ever to call a port in the US.

Table 6: Requirements

Requirements	Cooperation and Coordination	Incentives / Taxation	Capital Investments	Information Technologies	New Technologies (Hardware, Equipment, Vehicles)	Infrastructure Improvements	Regulatory Framework
Chassis-PoP	+++		++	+++	+	++	+
Integrated Dray Services	+++	++	++	+++	+	+	++
Advanced Appointment/Reservation Systems	++	+	+	+++	+	+	+
Load Matching/Maximizing Capacity	+++	++		+++			+
Improving Traffic Mitigation Fee Programs		++		+		+	+
Relaxing Vehicle Size and Weight Restrictions			+			+++	+++
Receiver-led Consolidation	+++	+++		+			+
Voluntary Off-Hour Delivery Programs	+++	+++	+	+	+		+

(+) denotes a low level of effort/investment. (++) denotes a moderate level of effort/investment. (+++) denotes a high level of effort/investment.

In addition to the previous factors, the proposed strategies could also provide some opportunities (directly or indirectly) to introduce or foster the implementation of new or sustainable technologies. These include, zero or near zero emission vehicles and equipment; improvement and retrofits to existing facilities; automation; and the implementation of information technologies. The qualitative assessment (see Table 7) is done under the following assumptions: 1) these strategies will provide system efficiencies that translate onto operational efficiencies for the individual stakeholders; 2) system efficiencies also generate economic benefits; 3) operational and economic benefits will allow for the stakeholders to invest in some of those new technologies; and 4) other operational efficiencies, and improvements in the overall system conditions could allow for the use of the new technologies within their technical limitations (e.g., range of electric vehicles; loading capacity). Moreover, considering that the development of some of the strategies could be involve incentive and funding programs, these programs could also include the adoption of these technologies.

Table 7: Additional opportunities for the adoption and implementation of new technologies

Opportunities for Strategy	Sustainable Vehicles	Sustainable Equipment	Improved Facilities	Automation	Implementation of Information Technologies
Chassis-PoP	+	+++	+	+	++
Integrated Dray Services	+++	+	+	+++	++
Advanced Appointment/Reservation Systems		+	++	+++	+++
Load Matching/Maximizing Capacity	+		+	+	++
Improving Traffic Mitigation Fee Programs		+		+	++
Relaxing Vehicle Size and Weight Restrictions	++	+		+	+
Receiver-led Consolidation	+		++		+
Voluntary Off-Hour Delivery Programs	+++	++	+	+	++

(+) denotes a low positive effect. (++) denotes a moderate positive effect. (+++) denotes a high positive effect



In general, and also discussed in the first paper of this two-part series, the analyses showed that there is no single strategy that could address the range of inefficiencies currently affecting the California Freight System. While some of the strategies are intended to mitigate pressing issues, others could help to adapt and be able to mitigate the impacts of future trends, and operational patterns. Designing a plan to improve the freight efficiency should consider a set or packages of complementary strategies.

# OPERATIONAL MODERNIZATION AT DISTRIBUTION NODES

March 2016

A White Paper from the Freight Efficiency  
Strategies Development Group

**Lead Authors:**

**Thomas O'Brien**, California State University Long Beach

**Tyler Reeb**, California State University Long Beach

**Working Group Members:** **Alison Bird**, FedEx; **Mike Christensen**, Port of Long Beach; **Richard Coyle**, California Trucking Association; **Lee Kindberg**, Maersk Line; **David Litbatique**, Port of Los Angeles; **Peter Okurowski**, California Environmental Associates; and **Elizabeth Fretheim**, Walmart



National Center  
for Sustainable  
Transportation



## **About the Freight Efficiency Strategies Development Group**

In July 2015, Governor Jerry Brown issued Executive Order B-32-15, directing several state agencies to work together in developing an integrated action plan that will “establish clear targets to improve freight efficiency, transition to zero-emission technologies, and increase competitiveness of California’s freight system” and that the plan should “identify state policies, programs, and investments to achieve these targets”. In response, an interagency group was formed to oversee the development of the California Sustainable Freight Action Plan (CSFAP). Members of the interagency group include the California Air Resources Board, the California Department of Transportation (Caltrans), the California Energy Commission (CEC), and the Governor's Office of Business and Economic Development (GO-Biz). As part of developing the plan, the interagency group has solicited feedback from a broad range of stakeholders through a variety of engagement activities and outreach efforts. A component of this engagement was the development of the Freight Efficiency Strategies Development Group (FESDG) made up of freight experts from academia, industry, and government. The purpose and main task of this group was to produce a series of white papers that identify promising strategies for increasing the efficiency of the freight system. A series of six papers were developed over the course of six months. Each paper focuses on a specific theme for increasing freight efficiency within the larger freight system.

## **About the National Center for Sustainable Transportation**

The National Center for Sustainable Transportation is a consortium of leading universities committed to advancing an environmentally sustainable transportation system through cutting-edge research, direct policy engagement, and education of our future leaders. Consortium members include: University of California, Davis; University of California, Riverside; University of Southern California; California State University, Long Beach; Georgia Institute of Technology; and University of Vermont.

## **Disclaimer**

The content of the white papers produced by the group represents discussions among many individuals representing various freight industry stakeholders. It may not reflect consensus on the part of all of the participants, nor do these papers necessarily represent the official opinion or policy of the represented organizations, but rather a range of thinking that might be used to inform and build consensus for the development of the California Sustainable Freight Action Plan. Given the perspective of the various freight stakeholders, paper authors have attempted to include dissenting opinions and areas of concurrence where they may exist. This document is disseminated under the sponsorship of the United States Department of Transportation’s University Transportation Centers program, in the interest of information exchange. The U.S. Government and the State of California assumes no liability for the contents or use thereof. Nor does the content necessarily reflect the official views or policies of the U.S. Government and the State of California. This report does not constitute a standard, specification, or regulation.

## **Acknowledgments**

This study was funded by a grant from the National Center for Sustainable Transportation (NCST), supported by USDOT and Caltrans through the University Transportation Centers program. The authors would like to thank the NCST, USDOT, and Caltrans for their support of university-based research in transportation, and especially for the funding provided in support of this project. . The authors and working group members are grateful for the assistance of the following California State University, Long Beach students who conducted research and provided information in the development of this white paper: Orion Gould, Daniel Magno, and Jennifer Tran.

[page left intentionally blank]

# TABLE OF CONTENTS

EXECUTIVE SUMMARY ..... iii

Introduction ..... 1

Theme 1: Energy Efficiency At Marine Terminals ..... 1

    Statement of the Problem ..... 2

Theme 2: Improved Truck Access At Nodes ..... 12

    Truck Platooning ..... 12

    Virtual Container Yards ..... 19

    Design-based Guidelines ..... 22

    Weigh-in-Motion..... 31

Conclusion..... 37

References ..... 39

# Operational Modernization at Distribution Nodes

## EXECUTIVE SUMMARY

This white paper documents obstacles preventing operational modernization at trade nodes and then recommends strategies to address those challenges in ways that address the State of California’s goals to improve freight efficiency, economic competitiveness, and environmental sustainability. All of the strategies outlined in this report are intended to inform next steps in the development of the California Sustainable Freight Action Plan.

The first of those recommended strategies focuses on establishing energy independence at marine terminals through the use of energy microgrids. Using microgrid technology, marine terminals can become self-sustaining “energy islands” capable of independently generating their own energy supplies separate from legacy energy grids to maintain ongoing operations. In the event of natural or manmade disasters, marine terminals with energy grids could continue operations even if the main power grid in the region collapses. Additionally, marine terminals could sell excess electricity generated by their microgrids back to the main power grid in their respective region. Implementation of energy grids requires considerable financial investment as well as new partnerships with governmental and industry stakeholders. This white paper also explores ways to incentivize “buy-in” for energy grids into existing energy markets.

In addition to addressing the importance of energy efficiency and independence at distribution nodes, this white paper also addresses the importance of improving truck access at distribution nodes in a manner that addresses the three interrelated goals outlined in Gov. Brown’s executive order: economic competitiveness, movement toward zero emissions, and operational efficiency. To promote improved truck access at distribution nodes, the research investigated the use of truck platooning, virtual container yards, design-based guidelines, and weigh-in-motion strategies to improve freight efficiency.

Truck platooning involves a train of trucks traveling together at very close proximities to lower fuel costs and increase efficiency. Through the use of advanced wireless communication technologies, the second driver, third driver, and any subsequent drivers are able to brake at the same time as the first driver who controls the speed and pace of the train of trucks. Although further research, regulations, and technological advances are required for widespread implementation where any truck can join a convoy or train, potential benefit of this practice on diesel consumption, the environment, and the economy is significant.

Likewise, the effect of virtual container yards (VCY) on freight efficiency holds the potential of introducing new efficiencies into the freight transportation network. Despite the many technological advances in freight, truckers continue to transport empty containers when they return or pick-up goods. Carrying empty containers in this manner wastes time and money for drivers and companies; it also increases carbon dioxide emissions and unnecessary fuel consumption. However, implementation of VCYS can eliminate this inefficiency. VCY leverages

internet-based systems to locate empty containers in real-time and facilitates exchanges without the use of a physical container yard or distribution node.

The design-based guidelines outlined in this paper address physical design elements at distribution nodes that either aid or impede freight. Aside from designing facilities for truck types, loads, ease of movement and maneuverability, freight routes, and parking and loading zones at distribution nodes, design-based guidelines should be taken into account for routes within metropolitan areas connecting distribution nodes. Inefficient truck movements caused by poorly designed distribution nodes can have a similar negative net effect on the movement of goods, the economy, and the environment. Implementing design-based-guidelines at truck nodes can not only promote modern efficiencies but also increase safety for all modes of transportation, maintain truck mobility and access, and reduce negative environmental impacts.

To further ease movement between distribution nodes, this white paper also assesses the potential benefits of weigh-in-motion technologies. Traditionally, freight faces delays with the enforcement of weight limits. However, weigh-in-motion technology allows truckers to meet regulations while en route to their destinations. This not only eliminates travel time and the costs associated with it, but also increases overall freight safety, reduces equipment and highway damage, and curbs harmful air emissions. This White Paper concludes with recommendations that inform next steps in the development of the California Sustainable Freight Action Plan.



## Introduction

This White Paper presents best practices and recommendations on operational modernization at distribution nodes to increase the efficiency of California’s multimodal freight system. The Efficiency Strategies Development Group (EFDG) scope document states:

“This Think Tank will be focused on opportunities for Federal, State and local policies and the private sector to remove system-wide barriers to the efficient movement of freight.”

Toward that end, this document seeks to identify the interrelated factors that lead to congestion and bottlenecks at trade nodes that negatively impact the broader supply chain. Those challenges include, but are not limited to, obsolete infrastructure, lack of convenient access to optimal fuel and energy sources, technological barriers, funding difficulties, lack of industry engagement, and lapses in design and planning. After describing the obstacles preventing operational modernization, this paper will recommend strategies to address those challenges in ways that address the State of California’s goals to improve freight efficiency and environmental sustainability.

## Theme 1: Energy Efficiency At Marine Terminals

Port facilities require a tremendous amount of energy to power the broad range of transportation systems required to move freight in and out of terminals. As such, this puts a burden on legacy energy grids. To address the economic and environmental challenges facing California’s ports related to freight efficiency, the California Energy Commission and five ports spanning northern and southern California formed the Ports Energy Collaborative. The Ports Energy Collaborative provides a forum for the Commission and the ports to discuss important energy issues, mutual challenges, and opportunities for transitioning to alternative and renewable energy technologies (Ports Energy Collaborative California Energy Commission, 2016).

Using the Port of Long Beach’s Energy Island systems approach, and the Port of Los Angeles’s planned development of a port microgrid that is powered by the Los Angeles Department of Water and Power (LADWP) Harbor Generating Station (Port of Los Angeles, 2014), the ports seek to become self-sustaining facilities. Introducing microgrids into marine terminals is a new concept, therefore there is no significant body of literature addressing such implementation. To address this challenge, the research began with a careful review of Port of Long Beach Energy Island planning documents, the Port of Los Angeles’ planned development of a port microgrid, and correlated those findings with existing literature on the study of microgrids, which is a concept for which a larger body of research exists (particularly as a response to the damage and fallout connected to the struggling power grid on the East Coast after Hurricane Sandy). In this way, the forthcoming research on microgrids at marine terminals could also be applied to smaller marine terminals, airports, concentration terminals, and distribution centers.

## Statement of the Problem

The ports of Long Beach and Los Angeles have made commitments to use the best available technologies to avoid or reduce negative environmental impacts and promote sustainability, which has resulted in significant increases in electrical equipment. Reducing air emissions has become a priority for industry stakeholders across the supply chain, not just port operators. Industry stakeholders have made investments to meet the State’s Vessel at-berth regulations, and ocean-going vessels are required by law to reduce emissions while at-berth via shoreside power or an alternative method.

As the ports of Long Beach and Los Angeles move toward zero-emission goals, reliance on electrical power has dramatically increased, and on-terminal electricity usage is predicted to quadruple by 2030 compared to 2005 (Port of Long Beach, 2015). Thus, “electrical demands are increasing for management of the logistics of goods” (Parise, Parise, Martirano, Chavdarian, Su, and Ferrante, 2016). The Los Angeles and Long Beach ports require tremendous amounts of energy to power the broad range of transportation systems required to move freight in and out of terminals as shown in Table 1 which lists the energy consumptions of both ports in 2012.

TABLE 1  
ENERGY CONSUMPTIONS OF LOS ANGELES AND  
LONG BEACH PORTS IN 2012

Period 2012	Port of Los Angeles	Port of Long Beach
Total Annual Energy Consumption	200,000 to 250,000 MWh	150,000 to 200,000 MWh
Peak Hourly Average Demand	50 to 60 MW	40 to 50 MW
Minimum Hourly Average Demand	17 MW	15MW
Annual Average Demand	27 MW	21 MW
Total Annual Cost of Demand and Energy	\$28 to 32 MM	\$18 to 22 MM

(Parise, Parise, Martirano, Chavdarian, Su, and Ferrante, 2016)

Marine terminals put a tremendous burden on aging electrical energy grids, and ports face vulnerabilities to potential regional power outages that would hinder freight transportation. Therefore, it is imperative that the ports of Los Angeles and Long Beach develop a plan of action “to improve the overall power profile of Port operations in a manner that is protective of the natural environment and the Port’s continued economic viability and national competitiveness” (Port of Los Angeles, 2014). Furthermore, an adaptive, flexible action plan is needed due to advances and changes in technology and operations, making any “energy management” an “ongoing process” (Port of Los Angeles, 2014).

With the implementation of the Port of Long Beach’s Energy Island systems approach, ports can become “islands” of sustainable energy generation by using microgrids and energy storage systems. This solution will address the ports’ increasing demand for electricity as it transitions to more environmentally sustainable equipment. In addition, the development of an

organizational foundation and programs, policies, and studies similar to the “Energy Team” and the “Port Energy Policy” in the Port of Los Angeles will provide the necessary leadership and support to improve overall efficiency, reliability, and resiliency of energy operation and management (Port of Los Angeles, 2014).

### *Description*

The Port of Long Beach’s Energy Island Initiative seeks to “provide reliability, resiliency, and economic competitiveness to the Long Beach port complex and its marine terminal tenants via localized power generation and adequate fueling infrastructure to support clean transportation options” (Port of Long Beach, 2015). To accomplish this, the Initiative will create an “island” of renewable energy technologies with modular self-generation systems that utilize low carbon technologies, and load-controlling energy storage strategies (Port of Long Beach, 2015). A notable part of this Energy Island Initiative is the integration of intelligent storage systems in smart microgrids.

Microgrids are subsets of a greater grid and usually include their own energy generation, demand, and the ability to modulate priority energy distribution or storage (Chan, 2012). It can be as small as 100 kilowatts or as large as 100 megawatts. According to Parise, Parise, Martirano, Chavdarian, Su, and Ferrante (2016), smart microgrids are the “most revolutionary innovation” with the ability to reverse utilization of the shore-to-ship or ship-to-shore electrical power or storage, and in the future, docked ships may be local generators that can supply great quantities of energy<sup>1</sup> to the port grid or regional main grid. Smart microgrids are necessary for ports to optimally manage the energy flows and make grids efficient and self-sustainable systems (Martirano, Falvo, Sbordone, Arboleya, Gonzalez-Moran, Coto, Bertini, and Pietra, 2013). Below is an overview of the main components in a common microgrid:

---

<sup>1</sup> The creation of “great quantities” of energy is not conceivable in consideration of the purpose of the State’s at-berth regulations, which is to eliminate vessel emissions – regardless of the technical ability of vessels to do so or the desire to create energy independence.

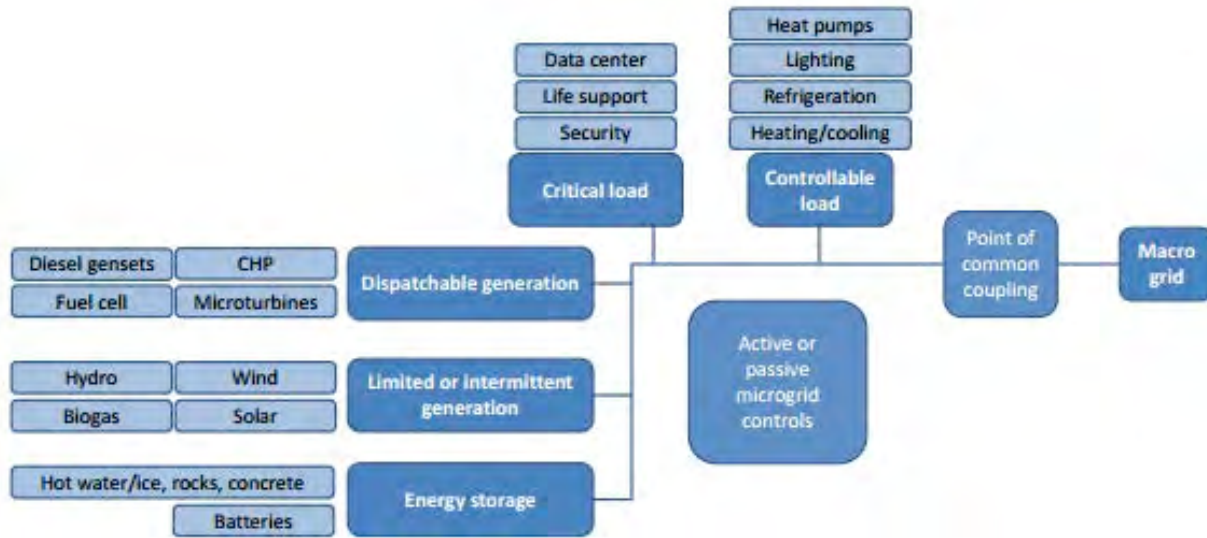

(Romankiewicz, Qu, Marnay, and Zhou, 2013)

Furthermore, smart microgrids are unique as they intelligently coordinate and balance different energy production technologies. When the microgrid detects a drop in solar generation for example, it can increase production elsewhere or reduce energy distributed in noncritical areas of the port to make up for the difference. Likewise, if wind generation exceeds demand, the microgrid can charge additional electrical vehicles or store the excess energy for later uses. “This intricate dance among supply, demand, and storage can enable a cleaner and more resilient future” (Chan, 2012). By using smart microgrids and storage systems, ports are able to take the form of an electrical “island” and ensure smooth production and distribution of electricity.

Developing sustainable sources of electricity are also featured in the Port of Los Angeles’s Energy Management Action Plan (2014). “Integration of energy management practices and renewable power generation to minimize the depletion of natural resources and provide economic, social, and environmental benefits,” is a stated goal. “Opportunities exist to strategically reduce greenhouse gas (GHG) emissions from terminal operations by either importing green electricity from LADWP renewable energy sources or generating clean energy at the Port. Local generation options that reduce GHG emissions can include natural gas-fired combined heat power (CHP), solar, wind, and offshore wind and wave energy.” Toward that end, the City of Los Angeles Harbor Department’s (Harbor Department) Photovoltaic (PV) Solar Power Program emerged from a partnership between the California Attorney General (AG), the Mayor of the City of Los Angeles, and the Harbor Department to reduce greenhouse gasses and support the Port of Los Angeles (Port) Clean Air Action Plan (CAAP). One of the goals of the partnership is for the Harbor Department to install 10 megawatts (MW) of PV solar power within the port, or other land owned by the Harbor Department, by the end of calendar year 2012 in two phases. Phase One would be the direct purchase of a one MW PV solar power system (PV System) by the Harbor Department for operation under the City of Los Angeles Department of Water & Power’s (LADWP) Net Energy Metering (NEM) Program. Phase Two

would be the installation of the remaining nine MW through a series of Request for Proposals (RFP) to solar power developers who would take advantage of federal, state, and LADWP incentives and operate the PV Systems under a future LADWP power purchase agreement (PPA) program.

As of February 2016, the Harbor Department has 1.6 MW of PV solar power installed within the Port's boundary. Since the Harbor Department was behind schedule to meet its 10 MW goal for various reasons, it requested and was granted an amendment to its partnership with the AG. The amendment details a path under which the Harbor Department would meet its 10 MW commitment by the end of calendar year 2018. At present, another 1.3 MW of PV solar power are under construction and 13.4 MW are under development through a combination of Harbor Department, Harbor Department tenant, and solar power developer projects. The Harbor Department anticipates it will both meet and exceed its 10 MW goal by the end of calendar year 2016.

With the implementation of microgrids, the architecture of the ports' electrical system must be considered as it significantly impacts the performance of the system. The structure can become increasingly complicated based on port area configuration, power sources (utility and renewable), and different power demands from varying equipment. There must also be plans for maintainability, flexibility, expandability (Parise, Parise, Martirano, Chavdarian, Su, and Ferrante, 2016).

Another part of the Port of Los Angeles' *Energy Management Action Plan (2014)*, is to form the "Energy Team" and establish the "Port Energy Policy." The main purpose of the Energy Team is to verify that projects and policies under the plan are implemented and followed. The Energy Team essentially serves as purveyors for the Port Energy Policy and the management of operations and energy at the Port. Under the plan, the team leader, or "project manager," is also responsible for creating plans to engage "key stakeholders" in the advancement of projects and other actions. To do so, the Energy Team consists of individuals from business development, engineering, government affairs, information technology, real estate, and legal, along with "experts knowledgeable in energy management and port operations" (Port of Los Angeles, 2014). Aside from the members' expertise in energy management and port operations, the Energy Team is strategically comprised of individuals with a range of skills and knowledge to accomplish a wide variety of tasks, such as:

- Coordinate with LADWP to plan, develop, finance, and implement energy infrastructure improvements;
- Collaborate with POLB on joint Port energy efforts;
- Develop and manage stakeholder outreach;
- Work with local, state and federal regulatory agencies;
- Oversee and manage studies and modeling efforts required to develop an Energy Master Plan;
- Manage energy-based technology programs;

- Develop and manage Port incentive plans;
- Serve as the Port interface with electricity and gas providers;
- Evaluate the findings and recommendations of energy-related studies;
- Develop education and outreach programs to increase energy awareness;
- Develop energy management best practices and training programs;
- Evaluate projects based on alignment with Port Energy Pillars;
- Identify and secure funding opportunities; and
- Adaptively manage the EMAP to take advantage of lessons learned, new technologies, and operational approaches” (Port of Los Angeles, 2014).

Aside from pushing the *Energy Management Action Plan* forward, the Energy Team is also responsible for improving collaboration with LADWP, port tenants, and other important stakeholders (Port of Los Angeles, 2014).

In terms of freight efficiency, this means the implementation of electricity-driven ports and greater terminal automation. This can increase freight efficiency and better address congestion management at distribution nodes. Also, with the implementation of an electrical port run by microgrids, there will be greater incentives and demand to use smarter vehicles that cause less traffic disruption and more efficiency through bottlenecks (American Highway Users Alliance, 2015). This is especially true when paired with an Energy Team that can manage energy and operations at ports and distribution nodes, and are already familiar with the research, evaluation, and implementation in the growing field of intelligent transportation systems (ITS) technologies in trucking. Furthermore, having a team of experts devoted to energy and freight will help ports like Los Angeles reach their goals in resiliency, availability, reliability, efficiency, and sustainability in freight efficiency.

### *Expected Benefits*

There are many benefits for ports and distribution nodes leveraging microgrids’ capability to balance one or more local power generation sources and self-sustaining nature. Benefits include:

- integration of renewable energy sources and reduced environmental impact,
- protection for critical infrastructure from power loss and maintaining operations during outages, and
- efficient management of energy production and consumption (Wartian & Putnam, 2013).

These benefits lend themselves to dependable, local energy efficiency and management, and enhanced safety and reliability. Real-world examples of microgrid reliability and resiliency are shown in Korea, Denmark, California, and Hawaii where microgrids have been stress-tested annually. This means that microgrids were disconnected from the greater or main regional grid,

and despite that, were able to meet peak power demands from its “island” of energy production and storage.

Another example occurred in 2009 in San Diego. When the rest of the San Diego utility grid was threatened by wildfires, the microgrid at the University of California, San Diego, continued to supply electrical energy to the university’s lighting system (Chan, 2012). The Halifax Port Authority announced its plan to be the first port in Atlantic Canada to provide shore power in 2013. Its goal was to provide shore power in 2014 and allow ships to plug in and turn off their auxiliary engines. Vessels are usually in port for approximately nine hours, and will emit no carbon dioxide, mono nitrogen oxides, sulfur oxides, or particulate matter from auxiliary generators while connected to shore power. This will dramatically reduce the Port of Halifax’s harmful air emissions (Sain, 2014).

A major expected benefit of implementing an Energy Team (as called for in the Port of Los Angeles *Energy Management Action Plan* [2014]), is that specific metrics and goals become viable for prioritization and tracking of various energy management and operation projects and studies. This will better position ports to reach their goals in resisting power outages, enhance recovery capabilities from natural disasters or grid outages, meet future power demands, minimize disruptions in operations, reduce energy usage and costs, and reduce harmful emissions. By assigning specific metrics of measurement to the selected criteria established in the energy management policy, specific, realistic, and obtainable goals can be determined. For instance, the Port of Los Angeles sets specific metrics to pinpoint when and where certain “power events” take place within the port. It also analyzes which individual tenants are affected by these power events, and how this effects the overall power system. The Port of Los Angeles encourages the Harbor Department and all the port’s tenants to record and track all data, so that benchmarks for energy consumption may be set and utilized for future planning (Port of Los Angeles, 2014).

### *How Microgrids Can Promote Freight Efficiency*

How can energy efficiency at marine terminals promote freight efficiency? The answer to this question requires a broad understanding of Gov. Jerry Brown’s executive order that calls for a new freight initiative that addresses three interrelated goals: economic competitiveness, a move toward zero emissions, and operational efficiency. If these three goals are to be reached, policy and planning efforts to bring those goals to fruition must be coordinated and reinforced rather than detract from each of the three individual goals.

In addition, implementation of microgrids may be cost-effective and improve the local economy by attracting new businesses, prompting quality jobs, advancing new technologies, and increasing customer retention (Port of Long Beach, 2013). For instance, Chevron Energy Solutions<sup>2</sup> installed a microgrid at Santa Rita Jail in Dublin, California, as part of the Department of Energy’s Office of the Electricity Delivery and Energy Reliability’s Renewable and distributed Systems integration program. The smart microgrid incorporated fuel cells capable of producing heat and power energy, solar photovoltaic system, wind turbine generators, battery energy

---

<sup>2</sup> Chevron Energy Solutions has been acquired by OpTerra Energy Services.

storage, and backup diesel generators. The incorporation of the microgrid reduced the jail's peak power load by 95 percent and reduced energy consumption during peak hours by 98 percent. The prison also annually saved \$110,000 on electricity bills (National Energy Technology Laboratory, 2014).

In terms of freight efficiency, the benefit of microgrids can be applied to hybrid and electric trucks. "A recent study found that the expansion of high-efficiency trucks can generate \$24 billion in net economic benefits and grow 124,000 jobs in the United States by 2030" (California Air Resources Board, 2010). In addition, this will have reduced long-term operating costs. Hybrid and battery-electric trucks have expanded body or chassis combinations that allow for greater freight efficiency, and the use of microgrids at distribution nodes can direct power to charge trucks (California Air Resources Board, 2010).

Furthermore, microgrids can support the industry's implementation of ITS in trucking to increase highway capacity, and utilization of cruise control in vehicles to allow safer platooning at closer distances and at higher speeds (American Highway Users Alliance, 2015). Already, "trucks with active emergency braking and blind spot warning systems are preventing rear-end and side swipe collisions that traditionally cause hundreds, if not thousands, of daily traffic jams" (American Highway Users Alliance, 2015). Microgrids can support these technological solutions and improve freight efficiency by providing power for these smart vehicles.

Other technological innovations in freight transportation that may need reliable resilient power provided by microgrids include: electrical toll collection, which greatly speeds traffic through toll booths, ramp metering, traffic signal coordination, automatic transmission shifting in trucks using advanced maps and real-time data to reduce fuel consumption and increase safety, and congestion pricing based on ITS technologies (American Highway Users Alliance, 2015).

Thus, with the continuous technological evolution in freight and demand for higher performances, it makes sense to develop an energy management team to meet operation efficiency. An energy management team, similar to the Port of Los Angeles' Energy Team, can organize and coordinate freight objectives and needs, operate controls, measures, and procedures to reduce energy consumption, and increase freight efficiency (Parise, Parise, Martirano, Chavdarian, Su, and Ferrante, 2016).

### **Expected Costs**

"A supply of reasonably priced and reliable power is the number one consideration for large scale electrification efforts at ports" (Sain, 2014). According to the Port of Long Beach fiscal report, it allocated \$750,000 for Energy Island Initiative planning activities (POLB, 2015). Since the Energy Island Initiative is specific to the Port of Long Beach and is still in its initial planning phase, expected costs for the initiative are unknown. However, as the Port moves forward with its Initiative Planning phase, specific milestones and funding will be clearer with the implementation of the initiative's three phases, shown below:





The Program Overview states that the Port anticipates Phase 1 of the program to be implemented over the next one or two years, and Phase 2 will be approximately three years. The Port of Long Beach plans on completing Phase 3 and overall implementation of the project in approximately ten years (Port of Long Beach, 2015).

Elsewhere, in a cooperative initiative between the Halifax Port Authority, the Government of Canada, and the Province of Nova Scotia, the Port of Halifax plans to provide shore power for parked vessels in 2014. Part of that cooperative initiative calls for the implementation of microgrids as a baseline to apportion the power needed for the marine terminal. This was a \$10 million cooperative initiative (Sain, 2014).

In an interview in March 2015, Gil C. Quiniones, the President and CEO of the New York Power Authority (NYPA) and Chairman of the Electric Power Research Institute announced NYPA's plans to utilize microgrids in their energy efficiency plans. Through the NY Prize initiative, New York plan to fund up to \$100,000 for up to 25 microgrid feasibility studies, and \$1 million for up to ten detailed designs, and \$7 million for construction of up to five projects (Quiniones, personal communication, 2016).

### *Role of the Public Sector*

According to Sara C. Bronin, professor of law and program director for the Center for Energy and Environmental Law at the University of Connecticut, "In nearly every state, the legal and regulatory challenges to implementing microgrids are by far the biggest hurdle" (Magill, 2013). Therefore, the Port of Long Beach's Energy Island concept requires full collaboration with tenants, city agencies, departments, environmental groups, labor organizations, local colleges and universities, and community members.

Other lessons can be drawn from the experience of microgrids in other locations. According to the New York State Energy Research and Development Authority (2010), microgrids are not defined in the New York State law governing the electric and steam industries. Therefore, in their implementation, ownership and service models are not illegal. However, microgrid features will vary depending on the technologies deployed, whether the system is located on private or public property, or whether serving residential or unaffiliated customers, and size of the distribution area (New York State Energy Research & Development Authority, 2010).

However, according to Quiniones (2016), the New York State Public Service Commission's Reforming the Energy Vision (REV) is "transforming how customer energy projects, including microgrids, participate in NY energy markets." This means that the New York State Public Service Commission has implemented not only policy regulations since 2010, but also regulations that add incentives to building microgrids. New York recognized the benefits from

microgrids' automated control technologies that enable local energy sources to seamlessly operate as part of a main grid or independently from it (Quiniones, personal communication, 2016). With regulations that will create a market for microgrids, New York is easing the public sector's burden to supply energy by making it possible for small businesses to build microgrids and generate revenue, thereby producing jobs and jump starting the local economy.

Romankiewicz, Qu, Marnay, and Zhou (2013) recommend policymakers "develop standards and processes for interconnection of microgrids" as soon as possible. This will require policymakers to proactively plan for short-term reviews, but also be able to evaluate the large scale impacts of a microgrid. Also, to increase incentives to monetize microgrids, policymakers should "consider modifications to electricity rate design" (Romankiewicz, Qu, Marnay, and Zhou, 2013). This means looking at pricing and demand charges on both the purchase and sale side of the microgrid transaction. Furthermore, the public sector must take stock of current incentive policies and analyze the barriers and opportunities to implementing microgrids (Romankiewicz, Qu, Marnay, and Zhou, 2013). This will allow the public sector to better enable the use of microgrids in various industries and communities.

### *Implementation Challenges*

A major challenge involved in the implementation of microgrids is assessing how the cost of microgrid technologies will change over time, and how vulnerable such facilities might be to changing fuel and energy grid costs. Onsite energy storage also needs to be assessed along with dependence on fuel supplies and deliveries. "While technology advancements are facilitating business and utility microgrid implementations, the integration of distributed generation into a utility system is not a trivial matter and facility and utility experts need to proactively get involved to address emerging issues" (Masiello, 2013).

According to Parise, Parise, Martirano, Chavdarian, Su, and Ferrante (2016), ports have the unique challenge of limited potential onsite renewable power generation. This is due to the fact that land area is comprised of marine terminals dedicated to maritime goods movement operations.

The most common technical barriers to microgrids include technology components, dual-mode switching from main grid connection to "island," power quality control, and protection issues. Also, regulatory barriers exist in interconnection rules with the main grid and the bi-directional power flow between the microgrid and the main grid. There are unfair cost distributions between entities utilizing microgrids and with shared local and regional power trade. So, despite the "push to build microgrids," the "laws and rules governing the sale and transmission of power" are too new to fully regulate the implementation of microgrids (Magill, 2013). According to Romankiewicz, Qu, Marnay, and Zhou (2013), "there is not a strong enough policy signal for widespread deployment of microgrids." So an international standard does not exist nor a general implementation plan for microgrids.

The main financial barrier, however, lies in the high investment needed to implement microgrids and replacement costs of the microgrid. Furthermore, there are stakeholder barriers with conflicting self-interests and expertise in managing microgrid operations (Soshinskaya, Graus, Guerrero, Vasquez, 2014).

Further challenges implementing microgrids in ports and distribution nodes reside in the complexity of related design requirements and operational specifications so that power systems may be efficiently built, operated, and maintained. Because microgrids are fairly new technology, the plan must allow for design revisions and experimental operational data as this will allow operators to identify and isolate issues in the complex system, adopt additional power sources, and efficiently configure power distribution. To fully leverage this data, however, requires an energy management team to measure, analyze, review, and coordinate projects to reduce energy consumptions and address inefficiencies (Parise, Parise, Martirano, Chavdarian, Su, and Ferrante, 2016).

### *Measuring Success*

The success of the Energy Island Initiative specifically for the Port of Long Beach hinges on whether the program accomplishes its five goals:

1. “Advance green power, both generated and purchased;
2. Use distributed self-generation with microgrid connectivity to provide energy security and sustainability;
3. Provide cost-effective, advanced fueling opportunities to port operators;
4. Improve energy and energy-related operational efficiencies; and
5. Attract new businesses, create new jobs, and produce higher revenues or cost savings” (Port of Long Beach, 2015).

In its Initiative Planning phase, the Port of Long Beach through its Energy Technology Advancement Program (ETAP) is seeking a funding partnership with Port tenants with emerging energy technology that may be applied to the seaport industry. The Port is particularly looking for technologies that will increase efficiency in port operations, improve energy reliability, and potential health and environmental benefits of reduced emissions (Port of Long Beach, 2015). This, along with the Port’s preliminary research on planning, studies, and pilot projects (e.g. large wind feasibility, port wide power-demand assessment, LNG siting, cost and demand, and distributed generation and microgrid feasibility among others) will determine whether the Port can successfully transition all of the Port’s power costs for terminal operations to renewable power sources, energy storages, and self-generation systems and controls.

To achieve this full transition, an energy management team is crucial to determine the success of fully implementing microgrids and to study its net effect on port operations and freight.

The successful transition may mean increased automation in port operations, and thus freight efficiency at distribution nodes. Also, leveraging the ports’ electrical power could result in increased use of hybrid or electrical trucks as the distribution node may also serve as charging station and incentivize the use of hybrid or electrical trucks. It could also encourage greater ITS implementation, leading to the automation and implementation of information-sharing technology that will make platooning more feasible.

## Energy Island

Benefits	Reduce environmental impact while providing high energy efficiency, reliability, and quality of the electricity service; self-generation allows hubs to “island” power source or to operate in isolation of main grid or supply power in event of natural or man-made disasters to community’s critical operations, cost-effective, attract new business, promote good jobs and advanced technologies, customer retention
Costs	For 2016, POLB will allocate \$750,000 for Energy Island Initiative planning activities; this includes research and pilot projects of advance marine terminal energy technologies
Public role	Collaboration with tenants, agencies, city departments, environmental groups, labor organizations, local colleges and universities, and community members; funding opportunities, energy evaluation, and incentive programs; regulatory changes to provide greater incentive for microgrids
Challenges	Limitation of potential onsite renewable power generation since land area is comprised of marine terminals dedicated to maritime goods movement operations; regulatory constraints (i.e. submeters not allowed) and lack of directives from energy management impede the necessary innovation to meet the new environmental and energy goals – need it for electric energy utilization; and existing rules and laws in area of cost for electrical power consumption and distribution of cost; high investment costs

## Theme 2: Improved Truck Access At Nodes

It is no secret that California is home to some of the most congested roadways in the nation. The American Transportation Research Institute (ATRI) and the Federal Highway Administration (FHWA, 2011) recently released a report on the top 250 worst bottlenecks in the country. Results from that study found that California was home to 15 of the 250 worst bottlenecks across the country. All 15 of those bottlenecks were among the top 160 worst bottlenecks, with seven in the top 100 and 13 in the top 150. In another bottleneck study released by the American Highway Users Alliance in 2015, California had 14 out of 50 of the worst bottlenecks in the nation. Although the two reports used different methodologies, both issued findings that pointed to the clear need for improved operational efficiencies across California’s supply chain. Truck congestion and bottlenecks lead to idling trucks that generate more toxic emissions, slowdowns in commerce, and congestion that impacts other modes of transportation—thus impacting quality of life for all Californians. To address truck congestion, this white paper recommends further investigation of a series of strategies to promote operational efficiencies at critical truck nodes. The first of those strategies is truck platooning.

### Truck Platooning

In addition to a need for improved velocity and efficiency within the transportation sector, environmental impact and cost reduction should also be major priorities. Transportation is

responsible for 28 percent of the nation's carbon emissions, second only to power plants at 31 percent (Davies, 2015). By nearly any measure, trucks play a significant role in contributing greenhouse gas, consuming more than 25 percent of the fuel burned annually. Fuel also accounts for 39% of overhead costs for the trucking industry with the average truck burning 20,500 gallons of fuel per year. New technologies and policies need to be embraced in order to improve fuel efficiency in trucks. An increase in fuel efficiency would allow for both savings in fuel costs, and reduction of emissions. Efforts have been made to increase the aerodynamics of truck fleets by utilizing fairings and other retrofitted accessories, but "there's so many electronics on there," Robinson [senior vice president of maintenance at flatbed carrier Melton Truck Lines Inc., Tulsa, Oklahoma] said. "You have to have a laptop with all the different software to check the engine, check the transmission, check the trucks, and so on and so forth (Clevenger, 2012)." This means that new ways to optimize fuel efficiency must be found, since there is push back against existing solutions.

### *Description*

One of the proposed methods to increase efficiency in the trucking industry is called truck platooning. Truck platooning is the process of tethering two or more trucks together with a wireless signal. "At the heart of platooning is a wireless electronic communications system, also connected to the internet, which tells the second truck when the first truck driver has braked. The second truck brakes almost instantaneously without driver intervention. In essence, both trucks brake at the same time (Kahaner, n.d.)." The front truck controls speed and braking for the whole chain of trucks, while the following vehicles remain engaged in steering. All trucks in the "train" are equipped with dash cameras and monitors that keep track of the road in front of the lead truck, as well as the road behind the rear truck. Though the concept has been touted for years as a remedy to high fuel costs and traffic congestion, it has not been until recently that technological advances have actually made it possible. With that said, there are still technological hurdles that need to be overcome before this practice can be used on a widespread basis. "It is envisioned that if a convoy needs to be joined, it would probably be a matter of driving to an entry ramp where the car would then poll vehicles on the motorway as it looks for a compatible convoy to mesh with for a required journey destination. (Fleming, 2012) It is still a nascent technology that is being tested in limited capacity trials in Europe as well as in the United States.

### *Expected Benefits*

Truck platooning impacts freight efficiency in multiple ways. When multiple vehicles are tethered together and heading in the same direction they can travel at higher speeds because drivers do not have to worry about predicting the moves of the other trucks. Furthermore, there are significant gains in aerodynamics as a result of truck platooning. There are essentially two kinds of drag: friction and pressure. Friction drag is the contact of air and the object moving through it. Pressure drag has to do with the low pressure created as the air moves around the object. In truck platooning, the lead truck eliminates a significant portion of the friction drag for the following truck(s). The following truck(s) help minimize the impact of pressure drag for the lead truck. This reduction in drag has been linked to up to 16% in fuel savings, reducing fuel costs and stops for fuel, which improves efficiency and shortens trips. The decreased fuel usage

also reduces the environmental impact of shipping, as less fuel is used and trucks give off fewer emissions when travelling at higher speeds.

Discussions of truck platooning have become increasingly ubiquitous as more research and related technology demonstrations reflect benefits in both shipping velocity and fuel efficiency. One such demonstration was carried out by Auburn University, in partnership with Peloton Technologies, a California based firm. The study was conducted at Auburn's GPS and Vehicle Dynamics Laboratory with the intent of testing a system of up to three trucks to convoy, tethered through a wireless driver assistive truck platooning system (DATP). The study found an estimated 7.5 percent increase in fuel efficiency, with the rear trucks using 10 percent less fuel, and the lead truck saving 5 percent (Auburn University, 2015). This result was in part due to achieving improved aerodynamics by decreasing the space between vehicles on the road, but also because trucks in the convoy can achieve uniform ideal speeds that give all participating trucks the benefit of added efficiency and reduced driving time (American Transportation Research Institute, 2015). Peloton estimates that if this model were to be applied to the entire trucking industry, companies could stand to save a combined \$6 billion worth of diesel per year (Peloton, 2016). When 40 percent of shipping fleets operating costs are in diesel, and the trucking industry accounts for ten percent of the nation's overall fossil fuel consumption and carbon dioxide emissions, the importance of increasing fuel efficiency is paramount.

In addition to the study that was carried out by Auburn University, Caltrans is carrying out a platooning test trial in conjunction with the UC Berkeley Partners for Advanced Transportation Technology (PATH) program. This technology demonstration will likely commence later this year. The test area will be centered in the Port of Long Beach/Port of Los Angeles area, and extend up to State Route 60. This new battery of trials intends to use pre-existing advances in platooning, and build off of them. One goal is develop and streamline the in-vehicle system that will control the tethering and speed regulation processes, as well the ability to tether up to three vehicles at a time. The other primary objective is to test and improve systems that will allow platoons to interact with traffic in a safe and consistent way, through maneuvers such as lane changing, merging, as well as joining and leaving a platoon mid-trip. The study also seeks to get driver feedback with regard to the preferred distances between platooning vehicles, and subsequently calculate the fuel savings for those distances (G. Larson, personal communication, March 1, 2016)

Overall, truck platooning research has been conducted regarding how systems like Peloton's can be deployed effectively on an industry-wide scale. Fleets and drivers who average trips of 500 miles or more have the most to gain from using DATP, while small fleets would still be able to reap benefits by using a "back office" system like Peloton's Network Operations Center to find other trucks to platoon with, potentially from other fleets. This type of model uses a central network and center for clients to log into, and get in contact with other users in order to collaborate on routes and create platoons. Small firms would be able to expect paying off their initial investment (hardware, software, installation) within ten months, whereas larger fleets could see payback in projected 18 months. The Auburn-Peloton study found that platooning systems at worst would only perpetuate the current levels of congestion, only having the ability to improve congestion. The report also found that, if market penetration were to reach 60%, there could be marked increases in efficiency and decreased traffic congestion across the

board, even for those not directly using platooning software. As increased trials produce greater amounts of quantifiable data, truck platooning will become a much more feasible option, and more palatable to both private and public decision makers.

The Auburn-Peloton technology demonstration and related analysis was funded by the Federal Highway Administration. A related business-case analysis on the demonstration was performed by the American Transportation Research Institute (ATRI), which addressed the users, sectors, and business models that are most likely to adopt the platooning approach. ATRI conducted an industry survey that solicited both carrier and driver cost and benefit expectations. Due to limited industry knowledge of platooning at this time, the survey should be viewed as an initial investigation that may be refined as stakeholders gain better understanding through demonstrations and pilot tests. Nevertheless, insights can be found from these early results. Findings from the survey include:

- The platooning concept is most advantageous when travel speeds are higher (because drag isn't a significant factor at lower speeds), truck trips are longer (i.e., benefits accrue over time/distance), and the likelihood of encountering similar trucks installed with DATP technology is high.
- Industry data derived from surveys and technical reports (e.g. ATA Trucking Trends 2013) indicate that over-the-road operations, with an emphasis on "truckload" (TL) and line-haul "less-than-truckload" (LTL) sectors would experience the highest likelihood of encountering the desired attributes. In particular, truckload operations often have pre-determined routes or corridors between large freight generators (e.g. business parks, manufacturing centers, warehouses, retail establishments).
- Truck routing: based on survey responses, 75% of the time the truck routing was determined in advance of the trip. Although the survey data shows that a meaningful number of these trips experienced unexpected route changes, the ability to potentially concentrate DATP-installed trucks through advance planning may increase industry interest, at least by those TL firms that have multiple DATP trucks and dedicated routes between freight generators.
- The largest percentage of TL trip mileage occurs on highways and interstates, which immediately improves the attractiveness of platooning to this sector. Based on the survey, 71% of the TL mileage was generated on limited access interstates and highways (ATA Technology and Maintenance Council, 2015)

In addition to domestic platooning research, there are also existing models of truck platooning tests that have been tested internationally, and which are being incorporated into developing systems for the U.S. The Safe Road Trains for the Environment (Sartre) program, founded by the European Commission under the Framework 7 program, emphasizes an approach that balances environmental impact, traffic safety issues, and congestion (Sartre, n.d.). It also investigates other possibilities of DATP, such as incorporating regular passenger vehicles into platoons, and of potentially allowing for platoons serving almost as mobile car pool lanes. This illustrates that not only are the regions in which platooning is being tested and refined diverse, but the approaches also vary in terms of objectives and scope.

The increasing volume of freight passing through transportation hubs and along transportation corridors over the past 10 years had created bottlenecks that are increasingly severe. With more material coming in, there need to be substantial changes to the way freight is moved in order to mitigate these bottlenecks. The trucking industry is essential to this effort, because without the ability to move goods more efficiently, the whole supply chain becomes compromised. As it stands, trucking corridors are highly vulnerable to traffic fluctuation, accidents, and infrastructure problems (either failures or construction projects).

This vulnerability is what creates a necessity for increased investment in ITS. “The implications of “smart mobility” and “connectivity” are therefore just as important for managers overseeing the flow of goods across oceans and rail lines as they are for the truck driver hoping to save half-an-hour of on-duty time by avoiding a crowded weigh station” (Cassidy, 2014). With more real time data coming from vehicles on the road, truck nodes such as ports and distribution centers will be able to anticipate and account for challenges while processing freight more efficiently and reflexively. Truck platooning may play a role in attaining this goal because it initiates the process of incorporating intelligent transport systems into the cab. For a larger quantity of up-to-date, descriptive data to be attainable, a mosaic of systems deployed simultaneously is required. Ideally, trucks would platoon through corridors to nodes, where they would be processed by peel-off systems, and would know which containers they would pick up well in advance due to coordination with virtual container yards. “As trucks travel interstate highways, onboard sensors are collecting, sending, and receiving information, with the lion’s share going to and coming from a fleet management system. But as technology advances, the truck is being knit into a broader, more open network” (Cassidy, 2014). Though each idea would improve operational efficiency in its own right, without combining multiple strategies the potential of each is diminished. Looking at the bigger picture, interconnectivity will be the new trend in transportation, meaning that what is happening at the port will affect movement on the highway, and vice versa. Therefore, truck platooning might be a corridor-focused practice, but its effects will influence the entire supply chain.

Testing of automated platooning has shown significant fuel economy benefits due to close-headway following enabled by the V2V communications link. A 2013 test of an early truck platooning implementation showed improvements on the order of 4.5% for the lead truck and 10% for the following truck, when traveling at (100 kph) 64 mph at (11m) 33 ft spacing.

In 2014, DOE’s National Renewable Energy Laboratory (NREL) conducted tests of platooning systems implemented by Peloton Technology. The SAE J1321 Type II Fuel Consumption Test Procedure was managed by NREL, using vehicles loaded at 65,000 lbs running at up to 70 mph. 20-75 foot inter-vehicle gaps were evaluated. The testing documented up to 5.3% fuel savings for the lead truck and up to 9.7% fuel savings for the trailing truck.

The Dutch research group TNO published an extensive study on two-truck platooning in early 2015. The authors note that the “political and economic climate is positive for a broad deployment of platooning as initial legislation amendments are proposed to allow testing and experimentation on Dutch roads” (Janssen, Zwijnenberg, Blankers, Kruijff, 2015). To maximize benefits, they introduce the concept of a Platooning Service Provider (PSP) to support ad hoc



formation of platoons. The PSP would help platoon partners find one another on the road, as well as certify participants:

“For on-the-fly platooning it is not necessary to know exactly where your platoon partner is going. However, for reasons of safety and trusting your platooning partner – especially if you are the driver of the Following Vehicle – you might want to know where your platoon partner is going, whether the leading driver took the required rests, and whether the Leading Vehicle is in good mechanical condition and is properly maintained. PSPs can establish quality schemes such that truck drivers can have the confidence that on-the-fly platoons are only formed with ‘trusted partners’. The PSPs also deal with administrative duties from the platooning activities, arrange insurances, and make sure that benefits of platooning are distributed fairly among the platooning partners” (Janssen, Zwijnenberg, Blankers, Kruijff, 2015).

They note that platooning “will allow a more optimal use of the available road capacity considering a normal situation with 2 trucks driving 80 km/h with a 2 seconds gap. With a truck length of 18.75 metres this results in a claim of 82 metre road, excluding the gaps in front of the first truck and behind the following truck. Using platooning, a 0.3 second gap would decrease the length of those two trucks with 46% to 44 metres. With platooning the existing roads will suffice longer without the need for additional lanes or roads, especially on road segments with a high percentage of trucks, so road investment projects could be delayed” (Janssen, Zwijnenberg, Blankers, Kruijff, 2015).

The TNO team provided a useful summary of overall benefits via this chart:

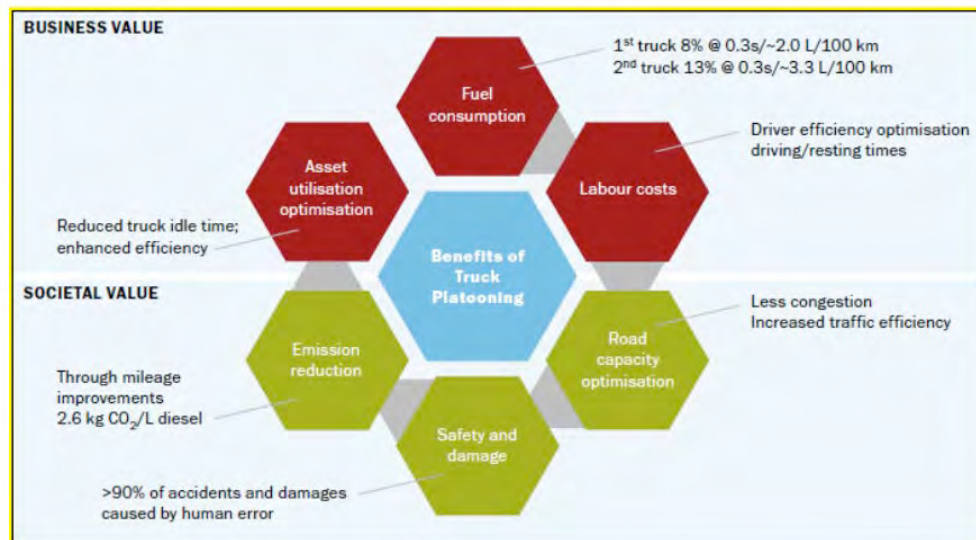

### Expected Costs

Due to the speculative nature of truck platooning’s development, it is all but impossible to give stable cost projections as much of the technology required is still in development, and there are different models being tested. There have been estimates of around “€ 1,500 per driver, based on experiences with LZV and SARTRE 14, including periodic re-examination,” but those can’t be

confirmed until technological concerns are settled (Janssen, 2015). Furthermore, depending on which model of truck platooning is employed, costs may fluctuate. Additionally, ““little attention has been paid to optimally coordinating the formation and dissolution of platoons to minimize total fuel use as many vehicles move throughout a road network” (Larsson, Sennton, and Larson, n.d.). This could pose major safety risks to both commercial and casual drivers on the road.

### *Role of the Public Sector*

Just as the costs are largely unknown, there are some major blind spots regarding what must be done on a state and federal level to ensure that this idea can be implemented. Regulations and laws wouldn't only be necessary for the feasibility of enacting a platooning regime, but also to allow for substantially “more efficiency... if we could convince the government to give drivers of autonomous vehicles a little more legal time on the road. (Considering the fact that our current hours of service regulations are still locked in unending cycles of litigation, I wouldn't hold my breath on that one)” (Lockridge, 2015). Regulations regarding distance between vehicles, cruise control, and sharing of information would need to be standardized across state borders.. Furthermore, there may need to be physical changes in infrastructure to allow for elongated chains of trucks travelling in unison (Janssen, 2015). Until the technology is solidified, tested, and there are tangible proposals on the table, it will be difficult to predict what must be done by the public sector.

### *Implementation Challenges*

There are numerous barriers to implementation that impact the feasibility of truck platooning. Unpredictable road conditions make the prospect of large trucks travelling at close proximity to one another a dangerous proposition, meaning that “automated vehicles will have to co-exist with manually driven vehicles as well as other road users (pedestrians, cyclists, etc.) [...]The literature reviewed indicates that this topic is somewhat neglected. (Azra, Englund, and Wedlun, 2013).” Fleet heterogeneity could also prove to be problematic, given that companies often have trucks of varying makes and ages in their fleets, some of which would be compatible and some that would not. Unforeseen maintenance costs would act as a deterrent to businesses implementing this strategy, especially without an established precedent or methodology. However, unpredictable road conditions, fleet heterogeneity, and unforeseen maintenance costs are self-evident challenges that legacy trucking firms also face. Viewed in this way those challenges should not be viewed as unique to only next generation platooning technology implementation. Alternatively, computational complexity does pose major concerns as to how wireless systems could account for potentially every truck in the United States being connected to their network. Yet, here again, this barrier to implementation should be viewed in the proper context—given that not all trucks are going to opt-in simultaneously. Such platooning networks will grow incrementally in a manner similar to the gradual buildout of wireless phone networks. That said, failures in wireless tethering systems could prove catastrophic in adverse weather or road conditions and safeguards must be developed.

## Virtual Container Yards

Densely populated freight nodes (e.g., LA-Long Beach, San Francisco Bay Area and New York-New Jersey regions) face trade imbalances between imports and exports which lead to significant increases in container traffic. It also worsens empty container management issues which include inefficient empty truck shipments to and from ports. (Theofani & Boile, 2007) Primarily, return trips carrying empty containers cause unnecessary congestion at terminals which not only affect overall flow efficiency, but increase CO2 emissions caused by idling (see figure below).

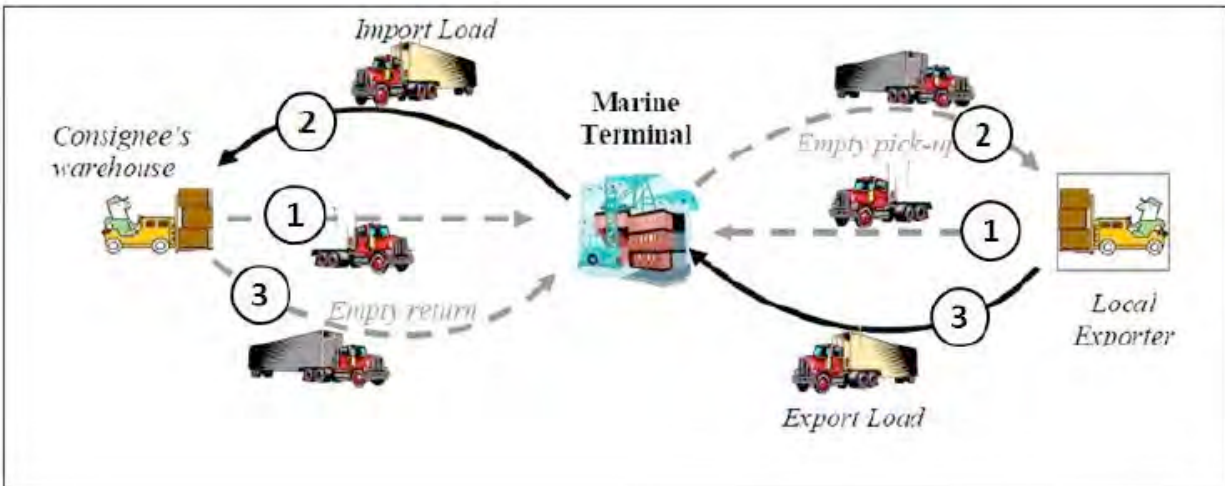

(Islam, Arthanari, Olsen, 2010)

Virtual Container Yards (VCY) are Internet-based systems that collect real-time information on the locations of empty containers to broker potential exchanges between participating parties without the need of a physical container yard. The key purposes of VCYS include:

- Posting critical information on cargo and containers locations statuses;
- Facilitate communication between participating businesses;
- Permit and document exchanges without moving containers to nodes; and
- Assist businesses in container logistic decision making (Hanh, 2003).

In essence, this would significantly alleviate congestion issues in addition to saving emissions and fuel consumption. Additionally, a private third-party would develop and facilitate potential transactions, diverting any implementation costs from the public sector. An example of the streamlined process is depicted below:

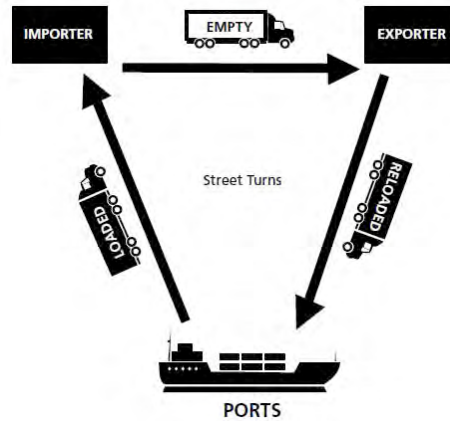

(Port of Long Beach, n.d.)

### Expected Benefits

Implementing VCYS benefit both freight nodes and participating businesses by reducing costs through gained efficient operations. Specific quantifiable benefits for freight nodes vary depending on the operational constraints of each node. For instance, the New York Metropolitan Committee determined that VCYS would eliminate approximately 1,100 vehicle trips to the New York and New Jersey ports per day. The burden would be on major economic centers to weigh benefits relative to their respective operations. However, freight nodes in general will avoid “additional gate transaction costs, grounding, storage and equipment costs,” and save carriers about \$200 per re-use transaction (Mongelluzzo, 2006).

From the participating business’ perspective, efficiencies created will translate into savings from reduced fuel costs and decreased time spent hauling empty containers. Both freight nodes and participants will benefit from low-start up and implementation costs since the third-party developer will be responsible for launching and maintaining VCYS software. Therefore, entities will only need to pay relatively nominal fees for software usage. VCYS implementation also aids reducing CO2 emissions by greatly reducing truck congestion and idling at major terminals (Gladstein, Neandross & Associate, 2013). The success of VCYS initiatives can only be made possible by company cooperation. Increased cooperation will exponentially amplify aforementioned benefits that affect nearly every part of the supply chain. Therefore, pushing for VCYS implementation will only strengthen overall economic vitality.

### Expected Costs

Cost considerations boil down to capital investments, annual operation costs, and annual maintenance costs. However, it is assumed that vendors will entirely cover maintenance and operating costs since they are the ones developing the software. Therefore, capital investments become the only cost concern for implementation. For instance, the following hypothetical capital investment alternatives were presented in a study investigating the feasibility of establishing VCYS in the New York-New Jersey region:

- The Port authority paying a percentage of the capital and the vendor pays the rest;
- The vendor paying the capital costs excluding installation/access fee; and
- The vendor paying the total capital costs, including the installation/access fee (Theofanis & Boile, 2007).

User costs will depend on the vendor's service. For an example of pricing and services, see eModal's company website: <http://welcome.emodal.com>.

There are also potential weaknesses to implementation that would do little to reduce current costs environmentally. First, congestion could move from freight nodes to VCY sites, therefore making overall emission reductions insignificant. Also, if current growth projections of VCY implementation hold, then respective initiatives will have negligible impacts on congestion, emissions, and fuel savings overall (Gladstein, Neandross & Associate, 2013).

### *Role of the Public Sector*

Industry-wide VCY acceptance is, in essence, a technological paradigm shift. Moreover, the technology depends on resource sharing mentality, which was already proven to be an issue since only 2% of container trips uses VCY services where available. (Gladstein, Neandros and Associates, 2013). Therefore, successful use of virtual container yards depends on addressing the following: 1) determining the main factors behind overall reluctance to participate in the virtual container yards and 2) spearheading collaboration and awareness efforts by highlighting the obvious economic benefits brought upon by increased port efficiencies.

Most failures can (at least) partly be explained through "weak project governance and limited partner participation" (Theofanis & Boile, 2007). Therefore, the role of the public sector includes engaging and accurately identifying general third-party reluctances that hinder implementation. Based on that, public sector entities should then develop a clear proposal that details compelling system governance that highlights the potential benefits of VCYs to economic vitality and how those benefits outweigh third-party concerns.

### *Implementation Challenges*

Virtual Container Yard software was launched nine years ago but proved ineffective due to a lack of demand for the service. Diminished demand could be related to implementation challenges with practical considerations. For instance, Le Dam Hanh, USC Department of Civil and Environmental Engineering, points out:

"... (to the extent that existing, or yet to be developed, Internet-based information systems can be successfully applied) successful applications of Web-based information depends on the willingness of all participants to share business information on a timely basis, and this particularly requires cooperation among ocean carriers. Without satisfying these basic conditions, the role of these systems in rationalizing empty container movements in the SCAG [Southern California Association of Governments] region would be limited."

Other considerations may include:

- "ocean carrier free time and per diem provisions;"
- "inspections and liability for damage on interchanged containers; [and]"

- “ocean carrier incentives for empty return versus export loading...” (The Tioga Group et al., 2009).

Finding export loads for inbound containers emptied at inland distribution centers may also prove difficult in heavy trade environments areas such as Southern California and New York-New Jersey where imports outnumber exports two or three to one (Mongelluzzo, 2006).

Overall, successful implementation depends on involvement from all key players within the system trying to be implemented. This emphasizes the necessity for understanding and responding to the inevitably varied needs and expectations of those players. However, renewed interest in the concept reemerged within recent years as evidenced by the development and growth of service provider [eModal](#). As aforementioned, only 2% of container trips use Virtual Container Yard services (where available) which suggests the demand problem persists (Gladstein, Neandros and Associates, 2013). That said, a 2% usage rate for Virtual Container Yard services should not be interpreted as an overall reluctance between companies to engage in cooperative arrangements but rather a slow evolution from traditional partnerships to next-generation technology driven partnerships. Intermodalism itself is based on cooperative arrangements and equipment interchange – these arrangements have only increased and become more dynamic over time. The lack of VCY use alone does not diminish these intermodal relationships or demonstrate a reluctance to engage in them; rather it is likely a more traditional market-based rationale. Regardless, significant growth opportunities exist for virtual containers yards and the burden is on the public sector to balance the costs and incentives to all commercial players and develop a compelling value proposition that includes and details the feasibility of implementation (including considerations any impeding information, institutional, and business-related barriers) (Theofanis & Boile, 2007).

### **Design-based Guidelines**

The White Paper research included a review of literature ranging from private-sector documents to Midwest and coastal state and city DOT plans that focus on design-based guidelines for truck access efficiency at nodes along the supply chain. Design-based guidelines, in this case, refer to the physical design elements that either aid or impede how trucks flow through nodes (e.g., ports, docks, airports, distribution centers). Portland’s Office of Transportation adopted its *Designing for Truck Movements and Other Large Vehicles in Portland* plan in 2008 which offered common examples of what these design guidelines may look like. For instance, when designing for truck traffic in any facility, designers need to adopt a “design for” mentality which means considering truck types and their movement capabilities. If a designer knows what truck types will be passing through an access point, they can evaluate track maneuvers of specific trucks using resources such as AASHTO turning templates of software such as AutoTURN (see Figure 1):

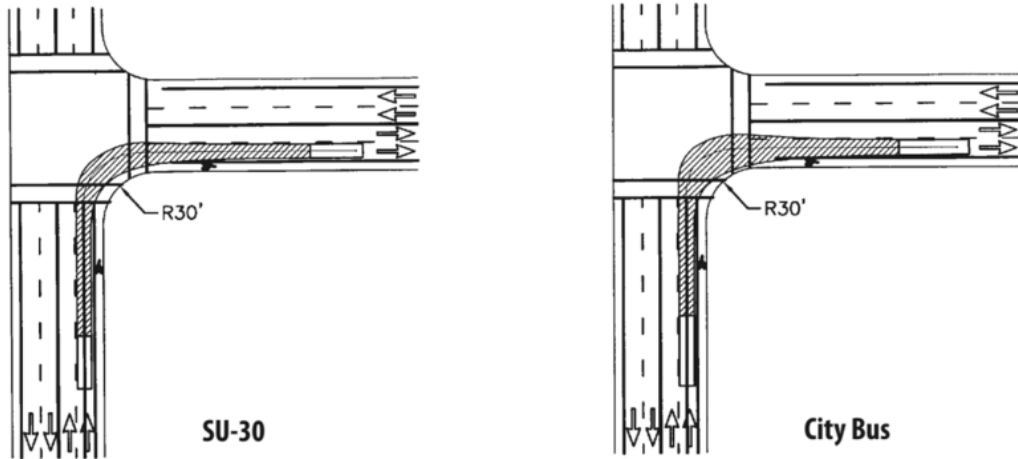

(Portland Office of Transportation, 2008)

NOVA Technology, a producer of loading dock equipment, published a document that offered design guidelines for safe and efficient docks. Like Portland’s document, NOVA presents practical guidelines for issues that identify best with design-based solutions. For instance, planning on-site traffic patterns serves towards efficient truck maneuverability within a dock. Patterns should be designed around buildings so that truck drivers are on the inside of each turn, giving them best control of the truck. Roads within a dock should also be separated so employee traffic does not interfere with truck movement (see Figure 2).

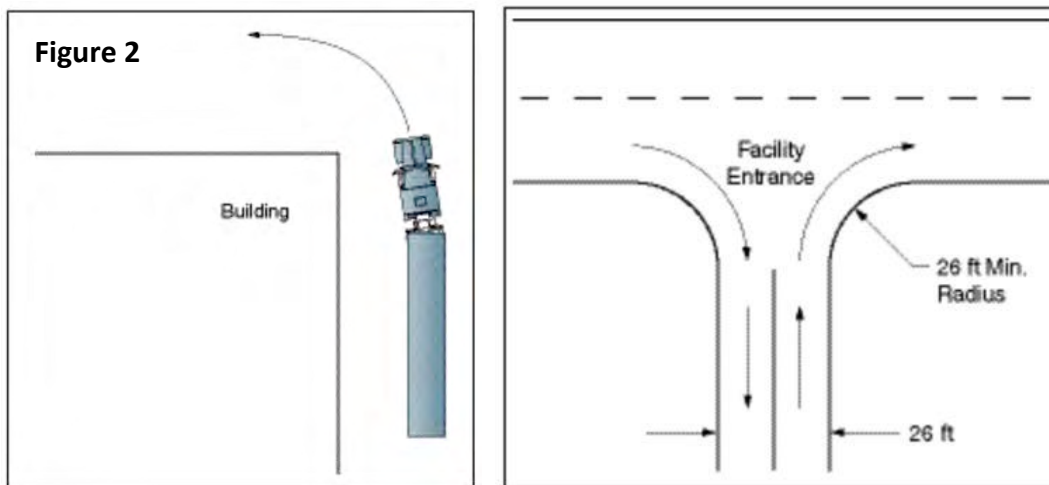

(NOVA Technology, 2013)

Other examples of common design-based guidelines for truck movement include (Washington State DOT, 2014):

- Designating truck freight routes for hazardous materials or oversize/overweight truck loads

- Managing curbside truck parking spaces/load zones
- Incentivize importers for adopting night delivery practices
- Providing truck parking and loading zones that match truck trip demand connecting to business districts and urban corridors

Note that while the examples from the Portland and NOVA documents address intersections and docks respectively, those guidelines provide transferable insight into possible solutions at other nodes such as ports or distribution centers. Moreover, the aforementioned examples help define design-based guidelines in context with issues covered within this white paper.

Truck access issues extend beyond the design elements of a specific node. Often times, access issues occur in routes connecting to the node within metropolitan areas. To demonstrate, the Chicago Metropolitan Agency for Planning (CMAP) points out:

“Compared to the 631 million tons moving by rail in the region, CMAP estimates that approximately 1.472 billion tons of freight was moved by truck in 2007 — more than 2.3 times the rail volume, and approximately 67 percent of the annual regional freight tonnage. Of this total, approximately 36 percent of all freight movements were through-traffic” (Chicago Metropolitan Planning Agency, 2010).

Furthermore, a 2013 study conducted by DKS Associates in 2013 focused on the outbound movement of goods from Westside C&E manufacturers to Portland International Airport’s (PDX) consolidation area. The study concluded that PDX is actually a critical freight hub along the company’s supply chain (see Figure 3) since most C&E freight moves out of PDX via truck. The study also found it is most efficient to truck goods to airports that have stronger links to overseas destinations. More importantly, the reliability of Portland’s roadway system (including rural roads with known deficiencies) is essential to C&E’s goods movement (DKS Associates, 2013).



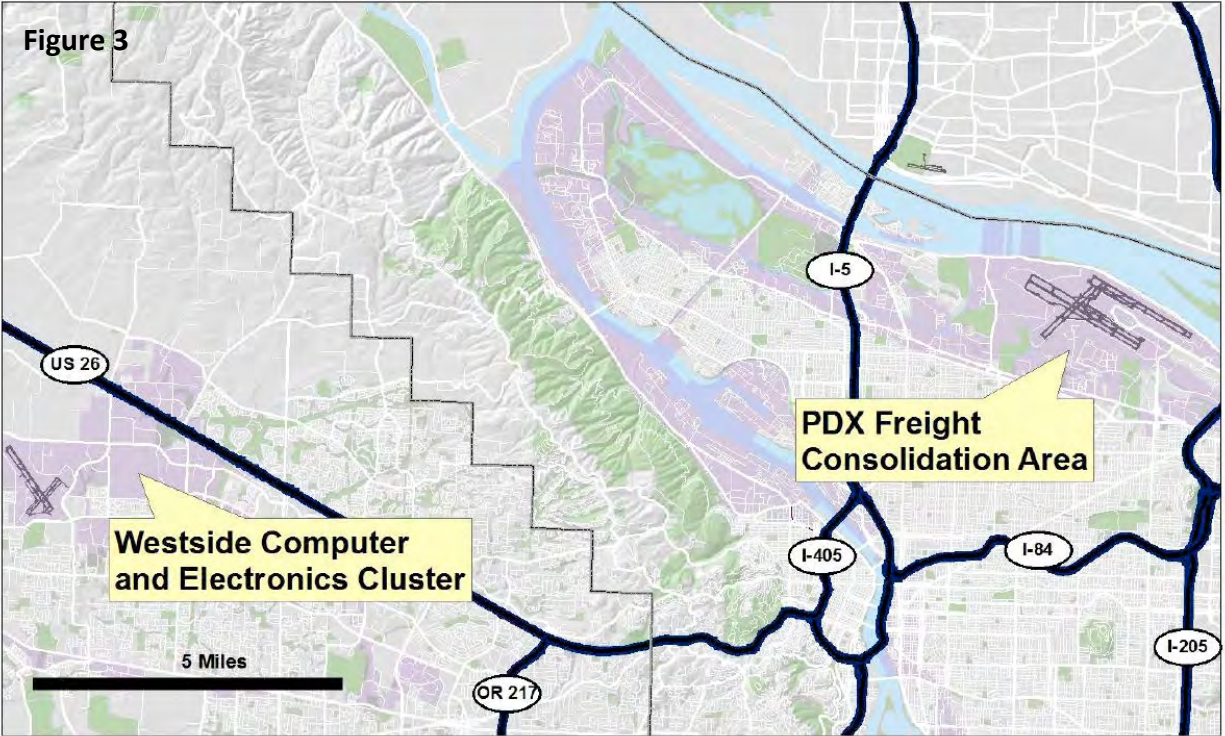

CMAP’s and DKS’s cases show the prominence of trucks within any given supply chain. Therefore, inefficiencies in truck movement have widespread consequences for the economic vitality of businesses and the communities they serve. While, several of these inefficiencies can be traced to truck access nodes, the interconnected nature of any supply chain cannot be ignored. Therefore, developing effective guidelines requires a systematic evaluation process. Specifically, answering questions such as: what inefficiencies impact truck access the most? Where are they occurring? How should projects addressing those issues be prioritized relative to other projects, and how much will the improvement process cost? Seattle’s Freight Access Plan exemplifies a structured approach that follows this line of questioning (see Exhibit 1):

**Exhibit 1**













(Seattle DOT, Port of Seattle, 2015)

Seattle evaluates every potential project within the framework of four potential goals (safety, mobility, connectivity, and environmental). Every project serves to improve environmental impacts. Moreover, each potential project could apply any number of improvement strategies (see Exhibit 2) that serve to achieve any of the aforementioned goals. This methodology develops a matrix that allows the city to “score” a pool of prospective projects and produce an effective prioritization list:

**Exhibit 2: Improvement Strategies, Project Goals, and Matrix**

• Maintenance and preservation	• ITS applications
• Capital investments	• Geometric improvements
• Intersection operations	• Freight management
• Wayfinding for trucks	

Goal	Objective	Performance Measures and Data
Safety	Increase safety for all modes	• Truck collision history
Truck Mobility, Reliability, & Throughput	Maintain and improve freight-truck mobility and access	• Volumes & vehicle classifications • Speed (from Chapter 3 & 4) • Buffer index*
Connectivity	Ensure network connectivity, especially for major freight inter-modal facilities	• Mobility constraints (e.g. railroad crossings, geometric constraints, intersection operations, over-legal limitations)
Environment*	Reduce environmental impacts	• Congestion/delay- from speed & travel time • Stormwater management

No.	Project Name	Project Need	Project Type						
		 SAFETY  MOBILITY  CONNECTIVITY	Maintenance & Preservation	Capital Investment	ITS Application	Intersection Operations	Wayfinding for trucks	Geometric	Ongoing Programs
<b>Ballard/Interbay Northend MIC</b>									
22	15th Avenue West Spot Improvements at W Dravus Street and W Emerson Street	 						✓	
52	BINMIC Truck Route Improvements	 				✓	✓	✓	
<b>Greater Duwamish MIC</b>									
5A	East Marginal Way South Roadway Rehabilitation	 	✓	✓	✓				
5B	E Marginal Way S / S Hanford Street Intersection Improvements	 	✓	✓		✓			

(Seattle DOT, Port of Seattle, 2015)

Many of the projects included in Seattle’s Freight Access Plan do not provide design guidelines for truck access at specific nodes. Some projects, however, provide a rich context as to how connections throughout metropolitan areas can affect truck movement to a particular node. For instance, the *15<sup>th</sup> Avenue West Spot Improvements* project addresses turn radii issues for trucks through small-scale geometric and intersection operational improvements (see Exhibit 3). The *East Marginal Way South Freight Roadway Rehabilitation* project evaluates the critical last-mile connector which provides access to Port of Seattle terminals, rail yards, and other industrial land uses in the Greater Duwamish manufacturing and industrial center. The route is also a vital route for trucks carrying over-sized or flammable cargo so the project also looks at optimizing safety within the route (see Exhibit 4). The project also seeks to rebuild the roadway to Heavy Haul route standards, upgrades signal hardware, and adds CCTV camera and dynamic message signs to improve overall truck travel conditions. Finally, the *Lower Spokane Street Freight Only Lanes Pilot Project* seeks to design, implement, and evaluate freight-only lanes on this major corridor that serves nearly 5,000 trucks daily in addition to connecting the Port terminals and providing other land uses to the regional highway system (see Exhibit 5).

# PROJECT AREA

## #22 – 15th Avenue West Spot Improvements W Dravus Street and W Emerson Street

### Exhibit 3



#### Freight Need

- ✓ Geometric constraints
- ✓ Recurring peak period congestion

#### Description

This project addresses turn radii issues for trucks through small-scale geometric and intersection operational improvements along 15th Avenue W. Trucks of all sizes experience challenges traveling on the elevated structures at W Emerson Street and W Dravus Street. 15th Avenue W, W Emerson Street, and W Dravus Street are vital connections for freight traveling to and from the Ballard/Interbay Northend Manufacturing and Industrial Center (BINMIC). This project includes two components to implement changes at these locations.

- The W Emerson Street ramp over 15th Avenue W serves trucks going to and from W Nickerson Street. This component includes moving the centerline on the ramp to provide a greater turning radius for trucks and making adjustments to the stop bars at the intersection on the west side of the ramp.
- W Dravus Street is used by trucks of all sizes, including over-legal vehicles unable to pass underneath the bridge on 15th Avenue W. Northbound trucks have particular difficulty turning left onto W Dravus Street from the off-ramp. This component of the project includes upgrading signal timing and hardware at the ramp terminals to ensure vehicle queues on the bridge clear to allow trucks adequate space to turn at the intersection.

#### Toolbox Treatments

Geometric Improvement

Intersection Operations

#### Project Elements

- ✓ Moving roadway centerline to improve turning radius
- ✓ Upgraded signal timing and hardware

#### Project Benefits

- ✓ Improved freight mobility
- ✓ Maintained connectivity
- ✓ Geometric improvements

#### Current Status

- ✓ Timeframe: 2015-2020
- ✓ Unfunded

#### Related Projects

- ✓ BINMIC Truck Route Improvements (#52)
- ✓ South End Ballard Bridge Bicycle Improvements



mobility  
reliability  
throughput



connectivity

(Seattle DOT, Port of Seattle, 2015)

## #24 – Lower Spokane Street Freight Only Lanes Pilot Project Harbor Island to Airport Way South

### Freight Need

- ✓ Recurring peak period congestion
- ✓ Heavy daily truck volumes

### Description

Lower Spokane Street is a primary freight route serving nearly 5,000 trucks daily and connecting the Port terminals and other land uses to the regional highway system. It currently experiences delays throughout the day caused by train crossings and intersection operations. This pilot project would design, implement, and evaluate freight-only lanes on the corridor. The first phase of the project would determine project limits; identify design options and new infrastructure needed to implement the pilot. The second phase would implement the modifications to roadway channelization for truck-only lanes, install signal and signage upgrades, and provide ITS equipment such as variable message signs and detection equipment. The project would evaluate time-of-day operations, while providing a contingency for allowing all traffic to use the lanes in the event of an incident on the upper bridge.

### Toolbox Treatments

Intersection Operations

ITS Applications

### Project Elements

- ✓ Signal and signage improvements
- ✓ Roadway delineation and restriping
- ✓ Variable message signs and detection equipment



mobility  
reliability  
throughput



connectivity

### Project Benefits

- ✓ Improved freight mobility
- ✓ Improved freight connectivity

### Current Status

- ✓ Timeframe: 2015-2017 (Study)
- ✓ Unfunded

### Related Projects

- ✓ S Spokane Surface Street ITS (#25)

## PROJECT AREA



(Seattle DOT, Port of Seattle, 2015)

## PROJECT AREA

### #5A – East Marginal Way South Freight Roadway Rehabilitation S Massachusetts Street to S Dakota Street (SR 99 ramps)

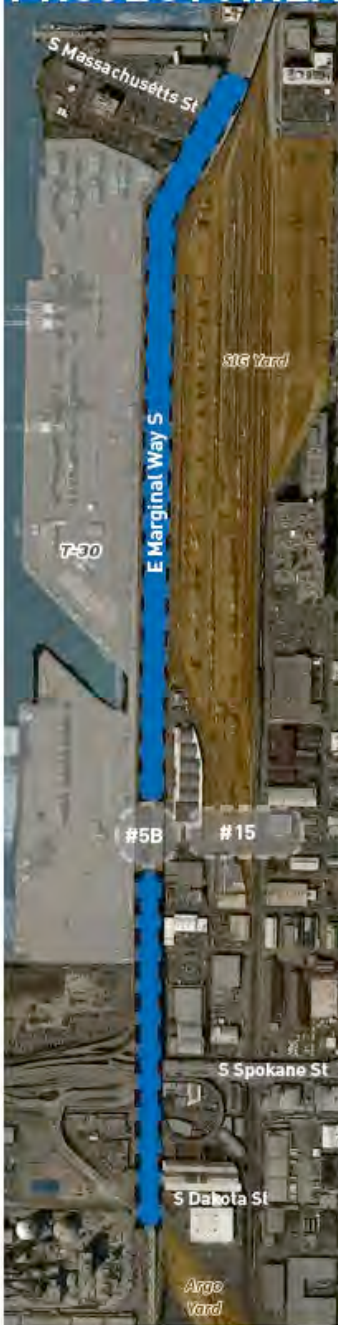

#### Freight Need

- ✓ Heavy truck volumes
- ✓ Recurring peak period congestion
- ✓ History of truck-bike collisions

#### Description

This roadway provides access to Port of Seattle terminals, rail yards, and other industrial land uses in the Greater Duwamish MIC. It is a critical last mile connector and a vital route for trucks carrying over-sized or flammable cargo. It serves as an important connection between the Greater Duwamish MIC and BINMIC areas. The roadway experiences recurring congestion during peak travel times. This project rebuilds the roadway to Heavy Haul route standards, upgrades signal hardware, and adds CCTV cameras and dynamic message signs to improve truck travel conditions.

#### Toolbox Treatments

Maintenance & Repair

Capital Investment

ITS Application



safety



mobility  
reliability  
throughput

#### Project Elements

- ✓ Heavy Haul route rebuild
- ✓ Roadway upgrades
- ✓ Upgrade signal timing and hardware (ITS)

#### Project Benefits

- ✓ Reduced travel time and increased roadway resiliency
- ✓ Last mile connector and Heavy Haul route
- ✓ Improved freight mobility
- ✓ Improved safety

#### Current Status

- ✓ Timeframe: 2015-2020
- ✓ Partially funded: ~\$250,000 (concept design)

#### Related Projects

- ✓ SDOT Multimodal Corridor Project
- ✓ E Marginal Way / S Hanford Street Intersection Improvements (#5B)
- ✓ Hanford & Main SIG Access Improvements (#15)

(Seattle DOT, Port of Seattle, 2015)

The importance of connecting both the broader scope of truck movements within metropolitan areas and design guidelines within truck access nodes cannot be understated. California faces

many of the same issues presented in the Seattle case studies: geometric constraints in designing truck routes, massive periods of congestion and heavy truck volumes in arterial routes connecting to major marine terminals such as the Los Angeles/Long Beach port complex; the push for active transportation initiatives; safety concerns; and overall efficiency in freight mobility and connectivity are but a few among a wealth of other concerns. Gaining perspective as to how much our economic vitality relies on trucking efficiency should create urgency in providing the resources necessary for ports, docks, airports, and distribution centers to optimize truck flow within their respective facilities.

### **Weigh-in-Motion**

Traditionally, static weighing was used to enforce weight limits. However, static weighing leads to freight inefficiencies in terms of delays and staffing demands. Staff is needed to intercept trucks in traffic flow to perform the weighing operation and to issue fines or apply other penalties to violators. Given that the static weighing process may take 10 to 30 minutes (sometimes more), the weighing area may be congested—causing delays. Further, overload trucks may bypass the check point, a violation that raises safety concerns.

To increase regulation and efficiency, technologies were developed to address the concerns listed above. Weigh-in-motion (WIM) technologies have been developed and implemented to address inefficiencies related to static weighing. “WIM technologies allow trucks to be weighed in traffic flow without any disruption to operations” (Jacob & Feypell, 2010).

WIM systems were first introduced in the United States in the mid-1950s. Since then, technological innovations have advanced the transportation system to include: low-speed WIM to high-speed WIM, road sensors, bending and load cell plates, strip sensors, multiple sensor, bridge WIM, video and automatic vehicle identification, among other applications, to increase freight efficiency and mitigate accidents and maintenance costs (Jacob & Feypell, 2010).

Furthermore, countries around the world are using WIM for enforcement. For instance, Taiwan implements high-speed WIM systems with large tolerances to enforce container weight regulations. Canada also operates high-quality and high-speed WIM systems to promote freight efficiencies as shown below:

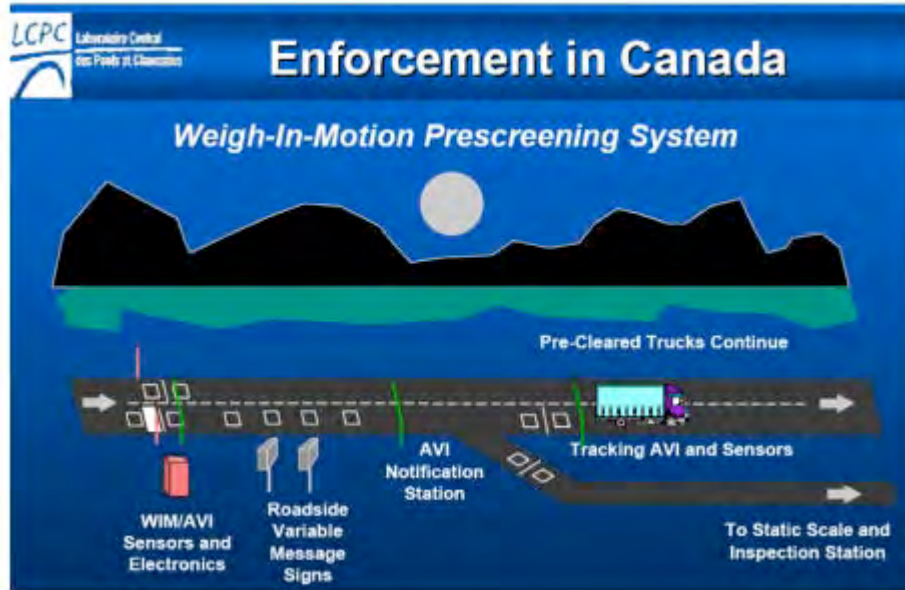

Due to the ensuring weigh pads implemented with the road surface to minimize vehicle dynamics (or bounce against the pavement), these high-speed WIM systems are very accurate in weighing trucks. Once the WIM system identifies a potentially overloaded truck, it diverts them to a weighing area. If the weigh station is not staffed, WIM only records for statistical purposes. Transportation systems in the Netherlands, France, Sweden, Japan, and other countries, however, use video cameras to constantly monitor overloads and send warnings to transport companies. Jacob and Feypell (2010) report that countries that implemented WIM technologies in 2007 experienced a reduction of up to 50 percent of the overloads observed. Although economic crisis and impact of road freight transport volume may have contributed to this reduction, this shows that this practice is very efficient in reducing overloading (Jacob & Feypell, 2010).

In terms of freight efficiency, implementing WIM systems will allow trucks to prove that they meet weight regulations without adding to their travel time. Trucks will be able to continue on their journey to distribution nodes without having to stop or wait in a queue to be weighed. With the WIM system, trucks are only required to drive over a pair of wired magnetic loops and a force sensor to be weighed as shown below:



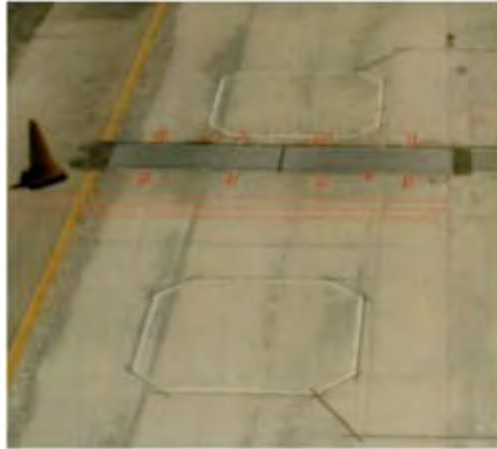

(Bajwa, 2013).

WIM technologies are effective in identifying trucks carrying overweight containers. “Trucks exceeding the legal mass limits increase the risk of traffic accidents and damage to the infrastructure. They also result in unfair competition between transport modes and companies” (Jacob, Feypell, 2010). In addition to being a danger on the road, overweight containers prove dangerous in port terminals and for the workers handling the containers.

According to the World Shipping Council (WSC) and the International Chamber of Shipping (ICS), overweight containers have proven challenging for industry, insurance, government, and the general public. After a joint industry-government research project regarding cargo securing that includes collapsing container stacks, the Maritime Research Institute of the Netherlands concluded that regulations for “compulsory weighing of containers prior to vessel loading” are needed (WSC and ICS, 2010).

This is because there is no reliable data that indicates how many containers are overweight. Some carriers report that it is not unusual for the total cargo weight aboard a ship to be three to seven percent greater than the declared weight. In a 2005 study by the Institute of Transportation Studies at the University of California, Berkeley, the average overload on freight trucks was more than five percent while the worst offenders averaged more than nineteen percent (ITS International, 2014).

The problems resulting from overweight containers include:

- Incorrect vessel stowage;
- Restowage of containers that result in delays and costs;
- Collapsed container stacks;
- Containers lost overboard;
- Cargo liability claims;
- Chassis damage;
- Damage to ships;
- Stability and stress risks for ships or mode of delivery;
- Risk of personal injury or death by workers;

- Impairment of service schedule integrity;
- Supply chain service delays;
- Exceed port draft limit;
- Lost revenue and earnings;
- Liability for accidents and fines;
- Time and costs with additional administrative efforts;
- Impairment of efficiency;
- Greater use of fuel;
- Greater vessel air emissions that is harmful to the environment and result in more fines (WSC and ICS, 2010);
- Disproportionate amount of road damage (ITS International, 2014);
- Accident risk and accident severity;
- Damage to infrastructure; and
- Unfair competition between transport modes and companies (Jacob & Feypell, 2010).

A reason for overweight containers is the switch from commodity pricing to container pricing (JOC Staff, 2016). This means that despite how full or empty a container is, companies are charged by the container.

In addition, Cottrell found that some truck drivers with overweight vehicles tend to bypass stationary weigh stations to avoid being cited for weight violations or motor carrier safety violations (1992). For example, in California, there are more than 125 weigh stations operated by the California Highway Patrol. The majority of the weigh stations are classified as mini-sites and are often unstaffed; however, when staffed and in operation, the California Highway Patrol found that “weight or loading violations are observed on a regular basis” (ITS International, 2014). The 2005 study by the Pavement Research Center estimates that between one and two percent of 78 million trucks are overloaded (2014). It is difficult to safely perform checks on heavily trafficked highways, and with high-traffic volume and number of heavy vehicles, the probability of being weighed is low (Jacob & Feypell, 2010).

Bypassing regulations leads to unfair competition between transport modes and companies that do obey the law and this impacts the economy. In France, it was estimated that a truck operating with a 20 percent overload all year round, generates an additional 25,000 euros every year. The illegal benefits of moving overloaded containers include tax evasion and additional profits. And while the operators benefit from such illegal practices, the burden falls on the state which must take on unaccounted for infrastructure and maintenance fees associated with overloaded containers (Jacob, & Feypell, 2010) and (ITS International, 2014).

To address the issue of overweight containers, “new technologies are being developed for more efficient overload screening and enforcement” (Jacob & Feypell, 2010). The Federal Highway Administration (FHWA) recommends an increase in the number of weigh-in-motion systems on highways to monitor truck loads.

### *Expected Benefits*

There are many benefits to implementing WIM systems as it discourages overloaded trucks by allowing states to enforce container weight limitation regulations. For example, it is shown that

an overloaded truck is more likely to be involved in an accident and result in greater damage to other vehicles or infrastructure as depicted below:



(Jacob & Feypell, 2010).

Such hazards are due to truck instability due to the braking system being unable to respond to the excess load, loss of maneuverability, or tire overhead, and increase risk of fire and severity of fire due to an accident or loss of control. WIM systems can mitigate chances of traffic accidents by decreasing the number of overloaded trucks. This will reduce costs for transport companies and states as it reduces travel time for many transport companies which may be caught in traffic accidents or delays to clean the road of the cargo and remove the vehicle, and damage to roads and highways (Jacob & Feypell, 2010).

In addition, states will also have less maintenance costs. The California Department of Transportation calculated that 10 percent axle overload results in 40 percent increase in road damage. This means that overloading containers have a major impact on the life of road's service (ITS International, 2014).

Furthermore, overloading leads to significant distortions in freight transport competition. This is true between different transport modes, e.g., rail, waterborne, and road, and between road transport companies and operators as overloading is a violation of taxation rules, such as vehicle registration fees, axle taxes, and toll infrastructure fees (Jacob & Feypell, 2010). By allowing some companies to overload their containers, bypass regulations, and skirt penalty fees, state agencies create an unfair industry market that may impede competition and encourage a monopoly in the transport industry.

By implementing WIM systems, states are addressing the problem of overloaded containers. In terms of freight efficiency, costs from overloaded containers, such as collapsed container stacks, cargo liability claims, chassis damage, risk of personal injury or death by workers, impairment of service schedule integrity, supply chain service delays, lost revenue and earnings, liability for accidents and fines, time and costs of additional administrative efforts and fuel are decreased or eliminated. Furthermore, WIM systems can significantly reduce the time

spent weighing containers to zero as it is done while the truck is travelling to its next destination.

As recommended by the Federal Highway Administration, the WIM system also helps ports decrease harmful air emissions from idling trucks in the weigh station queue (FHWA, 2015).

### *Expected Costs*

According to Bajwa (2013), current technologies for high quality WIM are too expensive to maintain and for widespread deployment. A unit with a lifetime of 10 years costs about \$497,000 for installation and \$6,240 for operation and maintenance (Caltrans, 2007). The high cost is due to the large and expensive load sensors and special pavement construction around those sensors.

An alternative WIM system that is less than a tenth of the cost is a vibration-sensor-based platform for an alternative intelligent transportation system technology. However, the lifetime for this is only two years (Bajwa, 2013). Therefore, there is a need for further research and development of inexpensive but accurate WIM systems that may be installed on new or existing roads.

### *Role of the Public Sector*

In response to the negative effects of overloaded containers, the International Maritime Organization created a new regulation under the Safety of Life at Sea (SOLAS) mandating that all containers must have verified gross mass (VGM) documents if they are to be loaded onto a ship. The document must also be signed either electronically or in hard copy by the shipper with the verified weight. This regulation came about after incorrect weight documentation contributed to maritime casualties on the southern U.K. coast in 2007 and the partial capsizing of a feeder ship in the Spanish Port of Algeciras in June, 2015 (JOC Staff, 2015).

Although this regulation focuses on containers loaded on ships, there are many transport companies that use multimodal transport. Therefore, this regulation helps prevent overloaded containers on trucks and railways as well.

However, details pertaining to the law are unclear, e.g., enforcement, margin of error allowed, and directions to handle containers that arrive at a port without the necessary documentation or the incorrect VGM. At this time, what is known is that the law provides two options to meet regulations:

1. “Weigh the container on a truck as it passes over a weigh station, subtracting the weight of the truck, chassis and fuel to determine the weight of the loaded container; or
2. Weight each item going into a container and add the sum of all the goods loaded to the tare weight of the container” (JOC Staff, 2015).

The U.S. Federal Maritime Commission needs to create clear and well-defined laws so transport companies and government agencies are better able to meet container weight regulations. Elsewhere, Japan has drafted guidelines and revised ministry ordinances that outline penalties and variations between the VGM and actual weight of a container, which includes administrative punishments such as fines for violators of the new international rules scheduled to be promulgated on April 1, 2016 (JOC Staff, 2016).

### *Implementation Challenges*

In addition to the high costs of high quality WIM systems, implementation challenges include a range of high maintenance costs, e.g., sensor durability under heavy loads, road damage, and pavement management as the sensor may be greatly affected by pavement temperature (Bajwa, 2013). Furthermore, there are problems for transport companies and government agencies in meeting the International Maritime Organization's new regulation.

According to the Journal of Commerce (2015), too many transport companies and government agencies are unprepared for the implementation of the new law, which goes into effect on July 1, 2016. Although weight information is required for the safe operation of vessels, some shippers say that it is not clear how to meet the options provided by the mandate.

In addition, the United States Coast Guard declares that it will not be responsible for policing the container weight mandate, and that enforcement will go to the ports. The Coast Guard will only be involved if it "boards an incoming vessel and finds it doesn't have VGM for each box" (JOC Staff, 2016). This means that ports must develop policies to enforce the mandate, and transport companies and government agencies must anticipate how ports will enforce it this coming July.

### *Measuring Success*

In terms of freight efficiency, the success of implementing WIM systems widespread may be gauged in terms of time, vehicles gas mileage, and how air emissions are reduced or negated. Further benefits—e.g. reduced overloading containers, infrastructure maintenance costs, highway traffic accidents, among other metrics—may need further study and research after the new weight limitation mandate. Also, the benefits of WIM systems depend on how strict the public sector and ports regulate weight restrictions on containers. The stricter they are, the more beneficial and important WIM systems become to freight efficiency.

## **Conclusion**

After reviewing a wide range of technological and planning strategies to promote operational modernization at distribution nodes, the White Paper suggests a series of next steps to inform the development of the California Sustainable Freight Action Plan.

- Installing microgrids at marine terminals and other large distribution nodes makes possible not only the obvious environmental and energy self-sufficiency benefits but also operational modernization. Similarly, microgrids can also support the industry's implementation of intelligent transportation systems (ITS) in trucking to promote other technological innovations that would benefit from the reliable and resilient power provided by microgrids. Such technologies include electrical toll collection, which greatly speeds traffic through toll booths, ramp metering, and traffic signal coordination. Given the expense and potential difficulties related to integrating microgrids into legacy infrastructure, this White Paper recommends that future research on this technology focus on incentive programs to expedite its implementation into traditional energy markets.

- Like microgrids, other innovative technologies that hold the promise of promoting operational efficiencies at truck nodes, should also be pursued in an integrated rather than siloed manner. Truck platooning is recognized as technology capable of reducing congestion on truck corridors. However, using new ITS applications to promote real-time information sharing of data gathered via platooning applications to truck nodes such as ports and distribution centers could empower future transportation professionals to anticipate and account for challenges while processing freight more efficiently. Truck platooning may play an important role in attaining this efficiency goal because it initiates the process of incorporating ITS into the cab.

For larger quantities of up-to-date, descriptive data to be attainable, a mosaic of systems deployed simultaneously is required. In this integrated and modernized future, truckers could presumably platoon through corridors to nodes, where they would access weigh-in-motion technology to eliminate a truck move, access a virtual container yard, or tap into an online supply chain scheduling system to determine the containers they were picking up long before they arrived at a marine terminal.

In the end, it will not be any one technology that will drive operational efficiency at trade nodes but rather a connected suite of integrated technologies that will be accounted for early in the planning phases and further enhanced by best practices in designed based guidelines.

It is important to understand that any recommendations for operational modernization at distribution nodes must account for the three interrelated goals outlined in Gov. Brown's executive order, which calls for: economic competitiveness, a move toward zero emissions, and operational efficiency. If all three of these goals are to be achieved, each must reinforce the other. For example, if zero-emission electric trucks are required in the future, it is imperative that distribution nodes—such as marine terminals, airports, border crossings, and distribution centers—are equipped with the electrical charging facilities to ensure that those zero-emission vehicles are able to recharge in a seamless manner that does not contribute to slower truck turns or extra truck moves to gain access to such facilities. Said another way, every strategy in the California Sustainable Freight Action Plan must engage the three-pronged focuses on economic competitiveness, environmental sustainability, and operational efficiency in an integrated rather than siloed manner.

## References

- Alcántar-Ruiz, R., Orue-Carrasco, F., & Martínez-Flores, J. (2014). Statistical model predicting freight transport fuel efficiency. *Global Conference on Business & Finance Proceedings*, 9.1, 537.
- American Highway Users Alliance. (2015). Unclogging America's arteries 2015 prescriptions for healthier highways. *CPCS Transcom Inc*. Retrieved from <http://www.highways.org/wp-content/uploads/2015/11/unclogging-study2015-hi-res.pdf>.
- American Transportation Research Institute. (2015). New research assesses potential for driver-assistive truck platooning. Retrieved from <http://atri-online.org/2015/05/27/new-research-assesses-potential-for-driver-assistive-truck-platooning>.
- American Transportation Research Institute & Federal Highway Administration. (2011). ATRI and FHWA release bottleneck analysis of 250 freight significant highway locations. Retrieved from <http://atri-online.org/2011/09/21/atri-and-fhwa-release-bottleneck-analysis-of-250-freight-significant-highway-locations>.
- Auburn University. (2015). Auburn university participates in heavy duty truck platooning study. Retrieved from <http://www.truckinginfo.com/news/story/2015/05/truck-platooning-report-shows-fuel-economy-gains.aspx>.
- Azra, H., Englund, C., & Wedlun, J. (2013). Current gaps, challenges and opportunities in the field of road vehicle automation. Retrieved March 7, 2016, from [http://www.vinnova.se/PageFiles/751290059/2013-05620\\_EN.pdf](http://www.vinnova.se/PageFiles/751290059/2013-05620_EN.pdf)
- Bajwa, R. (2013). Wireless weigh-in-motion: Using road vibrations to estimate truck weights (Doctoral dissertation). Available from University of California at Berkeley (UCB/EECS-2013-210).
- Bourgeois, T., Gerow, J., Litz, F., and Martin, N. (2013). Community microgrids: Smarter, cleaner, greener. *Pace Energy and Climate Center Pace Law School*.
- Bureau of Transportation Statistics, (2004). National Transportation Statistics 2004, 4. Retrieved from [http://www.rita.dot.gov/bts/sites/rita.dot.gov.bts/files/publications/national\\_transportation\\_statistics/2004/pdf/entire.pdf](http://www.rita.dot.gov/bts/sites/rita.dot.gov.bts/files/publications/national_transportation_statistics/2004/pdf/entire.pdf).
- California Air Resources Board. (2010) Making the Case for Hybrid and Electric Trucks and Buses. *Calstart*. Retrieved from <https://www.californiahvip.org/making-the-case>.
- California Energy Commission. (2016). Ports energy collaborative. Retrieved from [http://www.energy.ca.gov/highlights/documents/ports\\_energy\\_collaborative.pdf](http://www.energy.ca.gov/highlights/documents/ports_energy_collaborative.pdf).

- Caltrans. (2007). Unit cost element - Mainline (highway speed) WIM scale. *U.S. Department of Transportation*. Retrieved from <http://www.itscosts.its.dot.gov/its/benecost.nsf/ID/D0C88FEAAD07C62585257745003F15DB?OpenDocument>.
- Cassidy, W. (2014). Trucking enters new era of supply chain connectivity. *Journal of Commerce*. Retrieved from [http://www.joc.com/trucking-logistics/trucking-enters-new-era-supply-chain-connectivity\\_20140818.html](http://www.joc.com/trucking-logistics/trucking-enters-new-era-supply-chain-connectivity_20140818.html).
- Chan, A. (2012). Nation's largest microgrid online. *Rocky Mountain Institute*. Retrieved from [http://www.rmi.org/nations\\_largest\\_microgrid\\_online\\_esj\\_article](http://www.rmi.org/nations_largest_microgrid_online_esj_article).
- Chicago Metropolitan Planning Agency, (2010). Go to 2040: Comprehensive regional plan, 305. Retrieved from [http://www.cmap.illinois.gov/documents/10180/17842/long\\_plan\\_FINAL\\_100610\\_web.pdf/1e1ff482-7013-4f5f-90d5-90d395087a53](http://www.cmap.illinois.gov/documents/10180/17842/long_plan_FINAL_100610_web.pdf/1e1ff482-7013-4f5f-90d5-90d395087a53).
- Clevenger, S. (2012, July 30). Fleets enjoy fuel efficiency gains in new trucks, but express concerns on maintenance costs. Retrieved from <http://www.ttnews.com/articles/printopt.aspx?storyid=29837>.
- Cottrell Jr., Ben H. (1992). The avoidance of weigh stations in Virginia by overweight trucks. *Virginia Transportation Research Council & Federal Highway Administration*. Retrieved from [http://www.viriniadot.org/vtrc/main/online\\_reports/pdf/93-r2.pdf](http://www.viriniadot.org/vtrc/main/online_reports/pdf/93-r2.pdf).
- Davies, A. (2015, June 24). Making trucks more efficient isn't actually hard to do. Retrieved from <http://www.wired.com/2015/06/making-trucks-efficient-isnt-actually-hard/>.
- DKS Associates. (2013). Portland region Westside freight access and logistics analysis. 2-4. Retrieved from [https://www.portofportland.com/pdfpop/Trade\\_Trans\\_Studies\\_Westside\\_Freight\\_Access.pdf](https://www.portofportland.com/pdfpop/Trade_Trans_Studies_Westside_Freight_Access.pdf).
- eModal. [company website]. Retrieved from <http://welcome.emodal.com/?ReturnUrl=%2fDefault.aspx#ports>.
- Evans, M. (2016). Align efficiency programs, incentives and capital improvements with emerging microgrid projects [Press release]. Retrieved from <http://www.marketwired.com/press-release/align-efficiency-programs-incentives-capital-improvements-with-emerging-microgrid-projects-2092364.htm>.
- Federal Highway Administration. (2015). Freight and air quality handbook. *U.S. Department of Transportation*. Retrieved from <http://ops.fhwa.dot.gov/publications/fhwahop10024/sect3.htm>.



- Fleming, B. (2012). New automotive electronics technologies [automotive electronics]. *IEEE Vehicular Technology Magazine*, 7.4, 4-12.
- Gladstein, Neandross & Associates, (2013). Moving California forward: Zero and low-emission goods movement pathways, 61. Retrieved from [http://www.ucsusa.org/sites/default/files/legacy/assets/documents/clean\\_vehicles/Moving-California-Forward-Report.PDF](http://www.ucsusa.org/sites/default/files/legacy/assets/documents/clean_vehicles/Moving-California-Forward-Report.PDF).
- Giuliano, G., O'Brien, T., Dablanc, L., & Holliday, K., (2013). NCFRP report 23: Synthesis of freight research in urban transportation planning. *Transportation Research Board*, 6, 49. Retrieved from [http://onlinepubs.trb.org/onlinepubs/ncfrp/ncfrp\\_rpt\\_023.pdf](http://onlinepubs.trb.org/onlinepubs/ncfrp/ncfrp_rpt_023.pdf).
- Hanh, L., (2003). The logistics of empty cargo containers in the southern California region: Are current international logistics practices a barrier to rationalizing the regional movement of empty containers. *Freight Works*, 27, 28. Retrieved from: <http://www.freightworks.org/Documents/Logistics%20of%20Empty%20Containers%20in%20the%20Southern%20California%20Region.pdf>.
- Islam, S., Arthanari, T., Olsen, T., (2010). Empty container-truck movement problem: At ports of Auckland. *University of Auckland, New Zealand*, 242-244. Retrieved from: [https://secure.orsnz.org.nz/conf45/program/Papers/ORSNZ2010\\_Islam.pdf](https://secure.orsnz.org.nz/conf45/program/Papers/ORSNZ2010_Islam.pdf).
- ITS International. (2014). Weigh in motion helps Caltrans minimize road damage. Retrieved from <http://www.itsinternational.com/categories/classification-data-collection/features/weigh-in-motion-helps-caltrans-minimise-road-damage>.
- Jacob, B. & Feypell-de La Beaumelle, V. (2010). Improving truck safety: Potential of weigh-in-motion technology. *International Association of Traffic and Safety Sciences*, 34(1), 9-15. doi:10.1016/j.iatssr.2010.06.003.
- Janssen, R., Zwinjnenberg, H., Blankers, I., & Kurijff, J. (2015). Truck platooning: Driving the future of transportation. *TNO*. Retrieved from [publications.tno.nl/publication/34616035/dLijFM/janssen-2015-truck.pdf](http://publications.tno.nl/publication/34616035/dLijFM/janssen-2015-truck.pdf).
- James, R., & New York Metropolitan Transportation Coordinating Committee, (2006). The virtual container yard (VCY): A springboard for advancing port efficiency and environmental stewardship, 13. [Presentation]. Retrieved from [http://www.nymtc.org/project/freight\\_planning/Meetings/FTWG112806%20NYMTTC%20VCYPres%20%20PP-final.pdf](http://www.nymtc.org/project/freight_planning/Meetings/FTWG112806%20NYMTTC%20VCYPres%20%20PP-final.pdf).
- JOC Staff. (2015). Shippers' guide to the container weight mandate. *Journal of Commerce*. Retrieved from [http://www.joc.com/regulation-policy/transportation-regulations/international-transportation-regulations/jocs-container-weight-mandate-guide\\_20151214.html](http://www.joc.com/regulation-policy/transportation-regulations/international-transportation-regulations/jocs-container-weight-mandate-guide_20151214.html).
- JOC Staff. (2016). Solas enforcement goes to the ports. *Journal of Commerce*.

- Kahaner, L. (2015). Platooning is closer than you think – just like the trucks. Retrieved from <http://fleetowner.com/driver-management-resource-center/platooning-closer-you-think-just-trucks>.
- Knowler, G. (2015). New SOLAS rules have port equipment makers weighing options. *Journal of Commerce*. Retrieved from [http://www.joc.com/maritime-news/new-solas-rules-have-port-equipment-makers-weighing-options\\_20151218.html](http://www.joc.com/maritime-news/new-solas-rules-have-port-equipment-makers-weighing-options_20151218.html)
- Klemick, H., Kopits, E. , Wolverton, A. , & Sargent, K. (2015). Heavy-duty trucking and the energy efficiency paradox: Evidence from focus groups and interviews. *Transportation Research Part A: Policy and Practice*, 77, 154-166.
- Magill, B. (2013). Microgrids: A new kind of power struggle in New York and Connecticut. *Greentech Media*. Retrieved from <http://www.greentechmedia.com/articles/read/microgrids-a-new-kind-of-power-struggle>.
- Larsson, E., Sennton, G., & Larson, J. (2015). The vehicle platooning problem: Computational complexity and heuristics. *Transportation Research Part C: Emerging Technologies*, 60, 258-277. doi:10.1016/j.trc.2015.08.019.
- Lewis, P. (2013). Preparing a nation for autonomous vehicles: Opportunities, barriers and policy recommendations. *The Eno Center for Transportation*. Retrieved from <https://www.enotrans.org/etl-material/preparing-a-nation-for-autonomous-vehicles-opportunities-barriers-and-policy-recommendations/>.
- Lockridge, D. (2015, June). Commentary: The reality of autonomous trucks. Retrieved from <http://www.truckinginfo.com/article/story/2015/06/commentary-the-reality-of-autonomous-trucks.aspx>.
- Martirano, L., Falvo, M.C., Sbordone, D., Arboleya, P., Gonzalez-Moran, C., Coto, M., Bertini, I., & Di Pietra, B. (2013). Zero network-impact buildings and smart storage systems in micro-grids. *Environment and Electrical Engineering (EEIC)*, 284-289. doi: 10.1109/EEEIC-2.2013.6737923.
- Masiello, R. (2013). Microgrids introduce issues for utilities. *Intelligent Utility*. Retrieved from <http://www.intelligentutility.com/magazine/article/329471/microgrids-introduce-issues-utilities>.
- Mongelluzzo, B., (2006). IAS upgrades virtual container yard system. *Journal of Commerce*. Retrieved from [http://www.joc.com/maritime-news/ias-upgrades-virtual-container-yard-system\\_20061112.html](http://www.joc.com/maritime-news/ias-upgrades-virtual-container-yard-system_20061112.html).
- Mongelluzzo, B., (2006). Virtual container yard. *Journal of Commerce*. Retrieved from [http://www.joc.com/maritime-news/virtual-container-yard\\_20061001.html](http://www.joc.com/maritime-news/virtual-container-yard_20061001.html).

- National Cooperative Freight Research Program. (2009). Project 14 - Truck drayage practices. *University of Texas Center for Transportation Research, & University of South Carolina*. Retrieved from [http://onlinepubs.trb.org/onlinepubs/archive/NotesDocs/NCFRP14\\_Task3LiteratureReview.pdf](http://onlinepubs.trb.org/onlinepubs/archive/NotesDocs/NCFRP14_Task3LiteratureReview.pdf).
- National Energy Technology Laboratory. (2014). How an NETL-managed microgrid demonstration project reduced peak power loads and improved power reliability at one of the nation's largest jails. *U.S. Department of Energy*. Retrieved from <http://netl.doe.gov/newsroom/news-releases/news-details?id=2b5bada1-4f12-44e5-bb69-5b5e1b706cfb>.
- Nasir, M., Noor, R. , Kalam, M. , & Masum, B. (2014). Reduction of fuel consumption and exhaust pollutant using intelligent transport systems. *The Scientific World Journal*, 1-13.
- New York State Energy Research & Development Authority. (2010). Microgrids: An assessment of the value, opportunities and barriers to deployment in the New York state. Retrieved from <http://www.ourenergypolicy.org/wp-content/uploads/2013/08/10-35-microgrids.pdf>.
- NOVA Technology. (2013). Dock planning standards, 5. Retrieved from <http://docslide.us/documents/nova-dock-planning-standards-guide.html>.
- Parise, G., Parise, L., Martirano, L., Chavdarian, P., Su, C., & Ferrante, A. (2016). Wise port and business energy management: Port facilities, electrical power distribution. *IEEE Transactions on Industry Applications*, 52.1, 18-24. doi: 10.1109/TIA.2015.2461176.
- Peloton. (2016). Peloton technology. Retrieved from <http://www.peloton-tech.com/about>.
- Ploeg, J., Serrarens, A., & Heijen, G. (2011). Connect & drive: Design and evaluation of cooperative adaptive cruise control for congestion reduction. *Journal of Modern Transportation*, 19(3), 207-213.
- Port of Long Beach, (n.d.). Port Launches Virtual Container Yard. Retrieved from <http://www.polb.com/civica/filebank/blobload.asp?BlobID=3755>.
- Port of Long Beach (2015). Program overview: Port of Long Beach energy island initiative. Long Beach, CA. Retrieved from <http://www.polb.com/civica/filebank/blobload.asp?BlobID=13097>.
- Port of Los Angeles. (2014). Energy management action plan. Burns & McDonnell Engineering Company, Inc. Retrieved from [https://www.portoflosangeles.org/DOC/DRAFT%20POLA%20E-MAP\\_July%202014.pdf](https://www.portoflosangeles.org/DOC/DRAFT%20POLA%20E-MAP_July%202014.pdf).
- Port of Long Beach. (2015). Energy island. Retrieved from <http://www.polb.com/environment/energyisland.asp>.

- Port of New York, & Port of New Jersey, (2014). A Collaborative effort for a collective change, 21. Retrieved from: <https://www.panynj.gov/port/pdf/pptf-final-report-june-2014.pdf>.
- Portland Office of Transportation, (2008). Designing for truck movements and other large vehicles in Portland. 11,13. Retrieved from <https://www.portlandoregon.gov/transportation/article/357099>.
- Romankiewicz, J., Qu, M., Marnay, C., and Zhou, N. (2013). International microgrid assessment: Governance, incentives, and experience (IMAGINE). *China Energy Group*. Lawrence Berkeley National Lab.
- Sain, S. (2014). Electrification at ports: Plug-ins enabled. *American Association of Port Authorities Seaports*. Retrieved from <http://www.aapaseaports.com/index.php/2014/06/18/plug-ins-enabled/>.
- Sartre. (n.d.) Project partners. Retrieved from <http://sartreproject.eu/en/partners/Sidor/default.aspx>.
- Steenken, D., Voß, S., & Stahlbock, R., (2004). Container terminal operation and operations research - a classification and literature review. *OR Spectrum*, 26(1), 3-49.
- Seattle Department of Transportation & Port of Seattle, (2015). Seattle industrial areas freight access project. Retrieved from [http://www.seattle.gov/transportation/freight\\_industrialareas.htm](http://www.seattle.gov/transportation/freight_industrialareas.htm).
- Slack, B. (1990). *Intermodal transportation in North America and the development of inland load centers*. *Professional Geographer*, 42(1), 72-83.
- Soshinskaya, M., Graus, W., Guerrero, J. M., & Vasquez, J. C. (2014). Microgrids: experiences, barriers and success factors. *Renewable & Sustainable Energy Reviews*, 40, 659-672. doi: 10.1016/j.rser.2014.07.198.
- Sulbaran, T., & Sarder, M.D. (2013). Logistical impact of intermodal facilities. *American Society for Engineering Education*, 1(2), 4. Retrieved from: <http://se.asee.org/proceedings/ASEE2013/Papers2013/183.PDF>.
- Tindall, C. (2014). Autonomous platoons would reduce costs. *Commercial Motor*, 222(5610), 8.
- Theofanis, S., & Boile, M., (2007). Investigating the feasibility of establishing a virtual container yard to optimize empty container movement in the NY-NJ region. *Rutgers Center for Advanced Infrastructure and Transportation*. Retrieved from <http://www.utrc2.org/sites/default/files/pubs/Investigating-Feasibility-of-Establishing-Virtual-Container-Yard.pdf>.
- Wartian, M., Lyte, W., & Putnam, E. (2013). Electrical grid continuity in California port operations. [Presentation]. *Presented at METRANS International Urban Freight*

- Conference*. Long Beach, CA. Retrieved from <https://www.metrotrans.org/sites/default/files/WartianElectricEnergy.pdf>.
- Washington State Department of Transportation, (2014). Freight Mobility Plan. Retrieved from [http://www.wsdot.wa.gov/NR/rdonlyres/75650145-A0E9-4069-9FFC-148B2134CB72/0/AppG\\_UrbanGoodsMovementStrategy.pdf](http://www.wsdot.wa.gov/NR/rdonlyres/75650145-A0E9-4069-9FFC-148B2134CB72/0/AppG_UrbanGoodsMovementStrategy.pdf).
- Winter, K. & Campbell, B. (2009). Technology helps us do things better: Virtual weigh stations, other new methods for enforcing the law prolong highway life and increase vehicle citations. *Virginia Department of Transportation*. Retrieved from <http://vtrc.viriniadot.org/rsb/RSB22.pdf>.
- World Shipping Council & International Chamber of Shipping. (2010). Solving the problem of overweight containers. [Public address]. Retrieved from [http://www.worldshipping.org/public-statements/solving\\_the\\_problem\\_of\\_overweight\\_containers\\_for\\_release.pdf](http://www.worldshipping.org/public-statements/solving_the_problem_of_overweight_containers_for_release.pdf).
- Zhang, W., Huang, J., Tok, A., Chang, C., & Ritchie, S. (2014). The requirements and recommendations for development of a California weigh-in-motion test facility. State of California Department of Transportation. Retrieved from [http://www.dot.ca.gov/newtech/researchreports/reports/2014/final\\_report\\_task\\_1798.pdf](http://www.dot.ca.gov/newtech/researchreports/reports/2014/final_report_task_1798.pdf).

# PLANNING AND POLICY

March 2016

A White Paper from the Freight Efficiency  
Strategies Development Group

**Lead Authors:**

Thomas O'Brien, California State University Long Beach

Tyler Reeb, California State University Long Beach

**Working Group Members:** **Fran Inman**, Majestic Realty; **Annie Nam**, Southern California Association of Governments; **Will Kempton**, California Transportation Commission; and **Kerry Cartwright**, Port of Los Angeles



National Center  
for Sustainable  
Transportation



## **About the Freight Efficiency Strategies Development Group**

In July 2015, Governor Jerry Brown issued Executive Order B-32-15, directing several state agencies to work together in developing an integrated action plan that will “establish clear targets to improve freight efficiency, transition to zero-emission technologies, and increase competitiveness of California’s freight system” and that the plan should “identify state policies, programs, and investments to achieve these targets”. In response, an interagency group was formed to oversee the development of the California Sustainable Freight Action Plan (CSFAP). Members of the interagency group include the California Air Resources Board, the California Department of Transportation (Caltrans), the California Energy Commission (CEC), and the Governor's Office of Business and Economic Development (GO-Biz). As part of developing the plan, the interagency group has solicited feedback from a broad range of stakeholders through a variety of engagement activities and outreach efforts. A component of this engagement was the development of the Freight Efficiency Strategies Development Group (FESDG) made up of freight experts from academia, industry, and government. The purpose and main task of this group was to produce a series of white papers that identify promising strategies for increasing the efficiency of the freight system. A series of six papers were developed over the course of six months. Each paper focuses on a specific theme for increasing freight efficiency within the larger freight system.

## **About the National Center for Sustainable Transportation**

The National Center for Sustainable Transportation is a consortium of leading universities committed to advancing an environmentally sustainable transportation system through cutting-edge research, direct policy engagement, and education of our future leaders. Consortium members include: University of California, Davis; University of California, Riverside; University of Southern California; California State University, Long Beach; Georgia Institute of Technology; and University of Vermont.

## **Disclaimer**

The content of the white papers produced by the group represents discussions among many individuals representing various freight industry stakeholders. It may not reflect consensus on the part of all of the participants, nor do these papers necessarily represent the official opinion or policy of the represented organizations, but rather a range of thinking that might be used to inform and build consensus for the development of the California Sustainable Freight Action Plan. Given the perspective of the various freight stakeholders, paper authors have attempted to include dissenting opinions and areas of concurrence where they may exist. This document is disseminated under the sponsorship of the United States Department of Transportation’s University Transportation Centers program, in the interest of information exchange. The U.S. Government and the State of California assumes no liability for the contents or use thereof. Nor does the content necessarily reflect the official views or policies of the U.S. Government and the State of California. This report does not constitute a standard, specification, or regulation.

## **Acknowledgments**

This study was funded by a grant from the National Center for Sustainable Transportation (NCST), supported by USDOT and Caltrans through the University Transportation Centers program. The authors would like to thank the NCST, USDOT, and Caltrans for their support of university-based research in transportation, and especially for the funding provided in support of this project. The authors and working group members are grateful for the assistance of the following California State University, Long Beach students who conducted research and provided information in the development of this white paper: Esteban Barbosa and Daniel Magno, California State University Long Beach

[page left intentionally blank]



# TABLE OF CONTENTS

EXECUTIVE SUMMARY .....	iii
Introduction .....	1
Theme 1: Strategic Statewide and Interregional Freight Planning .....	1
Statewide Freight Planning .....	6
Theme 2: Truck Routes and Integrated Corridor Management As Examples Of Statewide Planning .....	10
GA Truck Lane Needs Study .....	12
Colorado RoadX .....	16
Illinois Truck Route Grant Program .....	16
Identifying and Prototyping Integrated Corridor Management Strategies for Application in Virginia .....	17
Conclusion .....	18
References .....	20

# Policy and Planning

## EXECUTIVE SUMMARY

The importance of freight transportation networks and other critical supply chain considerations are all too often buried in the planning functions of local government. Efforts such as the National Freight Strategic Plan are addressing this trend but coordination between state, regional, and local leaders remains challenging. To establish a broad perspective on ways that state departments of transportation (DOT) are facilitating interregional and statewide freight planning efforts, this white paper begins with a comparative analysis of state DOT organizational charts to identify where the freight planning functions are housed. This analysis features a historical comparison of how current organizational charts differ compared to earlier pre-2009 versions of state DOT structures.

Organizational structures and the internal freight priorities of state DOTs are critical, but so too are the modes of engagement used to gain comprehensive feedback from every stakeholder in the statewide supply chain. This outreach component includes strategic messaging, public information dissemination, public events, and in-person and online stakeholder engagement. To promote strategic statewide and interregional planning initiatives, public- and private-sector leaders must work together to address trends that have hindered such efforts for decades. Such trends include decentralized planning efforts, the deregulation of the transportation sector, a lack of coordination between local government leaders to plan for regional and statewide freight corridors, and failure to plan for inevitable conflicts between freight and commuter vehicles, transit operations as well as bicyclists and pedestrians.

On the most basic level, remedies for all of these above challenges will only be developed if civic coalitions of leaders from the public sector and the private sector find ways to make freight efficiency a top priority in the planning and policy stages of projects. Such agents of change correctly understand that if operational and technological innovations are to achieve their fullest potentials, planning and policy efforts must not only account for historical best practices but also respond to projected increases in freight volume and related technological challenges and opportunities.

To facilitate a process that drives statewide and interregional freight planning in California, this white paper identifies recommendations related to criteria that authors of the California Sustainable Freight Action Plan can use to benchmark the adoption of best practices. These best practices serve to elevate freight as a statewide priority within the organizational structure of state departments of transportation. This white paper also offers recommendations related to outreach best practices that leverage traditional in-person meetings and technology-driven methods.

## Introduction

This White Paper presents best practices and recommendations on planning and policy efforts that could increase the efficiency of California’s multimodal freight system. The Efficiency Strategies Development Group (EFDG) scope document states:

“This Think Tank will be focused on opportunities for Federal, State and local policies and the private sector to remove system-wide barriers to the efficient movement of freight.”

Toward that end, this white paper seeks to serve as a synthesizing document that provides an overview of how coordinated planning efforts can make the movement of freight more efficient in California. Analysis of those planning efforts will draw from best practices in other U.S. states and reference the land-use sections of the National Freight Strategic Plan and offer commentary that translates those national perspectives to state, county, and municipal jurisdictions. At every stage of analysis, this white paper will recognize policy limitations and offer recommendations that factor in the appropriate role of state governance.

## Theme 1: Strategic Statewide and Interregional Freight Planning

Although the movement of goods throughout our nation’s corridors determines the livelihood of people in every community—and comprises the lifeblood of the domestic economy—freight has long been buried in the planning functions of local government with insufficient attempts to coordinate efforts across jurisdictional boundaries and different levels of government. This trend is gradually changing with efforts like the National Freight Strategic Plan, but significant coordination between state, regional, and local decision-making bodies remains a challenge. Every obstacle preventing meaningful freight efficiency innovations on the national level is exhibited in California, a state with the seventh largest economy in the world and goods movement challenges more formidable than those faced by most nations.

To begin with, “there is little design guidance for developing land around freight facilities or corridors and land-use planners in local governments are generally not taught about freight as part of their standard educational curriculum. Smaller MPOs and local government planning departments may have staffs of only a few people and may find it difficult to obtain budgets to specialize in areas such as freight. Lack of a dedicated source of freight funding could also reduce MPO demand for dedicated freight staff” (U.S. Department of Transportation [USDOT], 2015, p.47). Further complicating matters is the reality that “while State DOTs and MPOs play a predominant role in planning public freight transportation infrastructure, local governments largely control land-use decisions that are critical to undertaking transportation projects or alleviating conflicting development patterns. The difficulty of coordinating among these participants has been frequently cited as a barrier to improved freight system performance, most recently by the U.S. DOT’s National Freight Advisory Committee (USDOT, 2015, p. 51).

To establish a broad perspective on ways that state DOTs are (or are not) attempting to promote interregional and statewide freight planning efforts, the research began with a comparative analysis of state DOT organizational charts to identify where the freight planning functions are housed. This analysis also featured a historical comparison of how current organizational charts differ compared to earlier pre-2009 versions of state DOT structures. This

review revealed that a majority of state DOTs have not changed their organizational structures in ways that demonstrate freight planning and policy is an elevated priority.

In California, for example, the Caltrans organization structure has changed in recent years, but not with regard to freight. The office of freight planning is housed within the Transportation Planning unit which is a division of Planning & Modal Programs. The Arizona DOT added an “Enforcement and Compliance Division,” but its freight plan is still housed within the state’s Multimodal Planning Division. Similarly, other states including Michigan, Minnesota, Georgia, and Illinois DOTs kept their freight planning elements housed within traditional planning divisions.

However, there were also some noteworthy examples of state DOTs that changed their organizational structures with regard to freight planning functions. The Florida DOT signaled a new focus on freight by changing the name of its freight planning division from “State Public Transportation and Modal” to “State Freight & Logistics” as shown here:

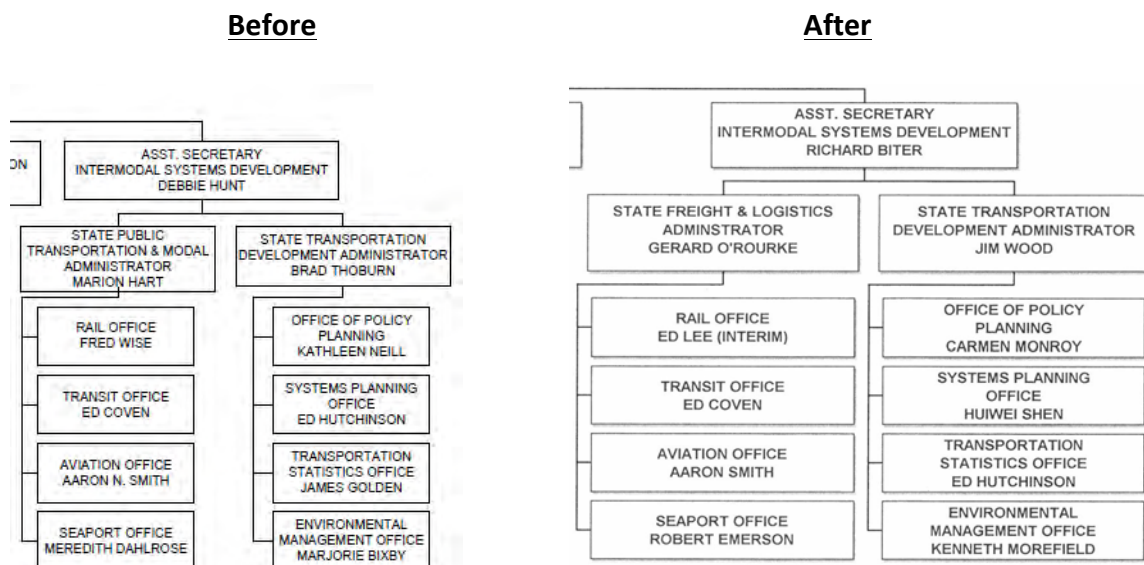

The New Jersey DOT also changed its “Capital Program Management” division in 2009 to “Capital Investment Planning & Grant Administration” in 2015. The latter now contains a Multimodal Service subdivision with a Freight Planning & Services department. The change is reflected below.

**BEFORE**



**New Jersey Department of Transportation  
Organization Chart  
June 2009**



**Capital Program Management**

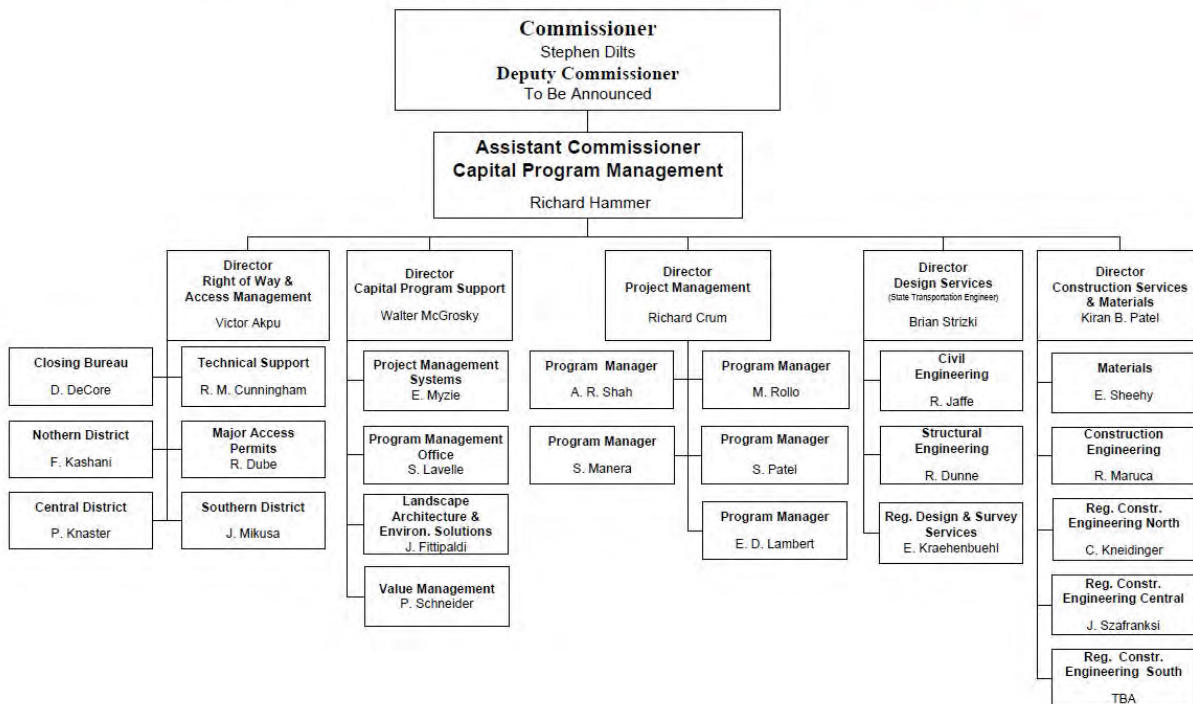

**AFTER**



**New Jersey Department of Transportation  
Organization Chart**  
December 2015  
**Capital Investment Planning & Grant Administration**

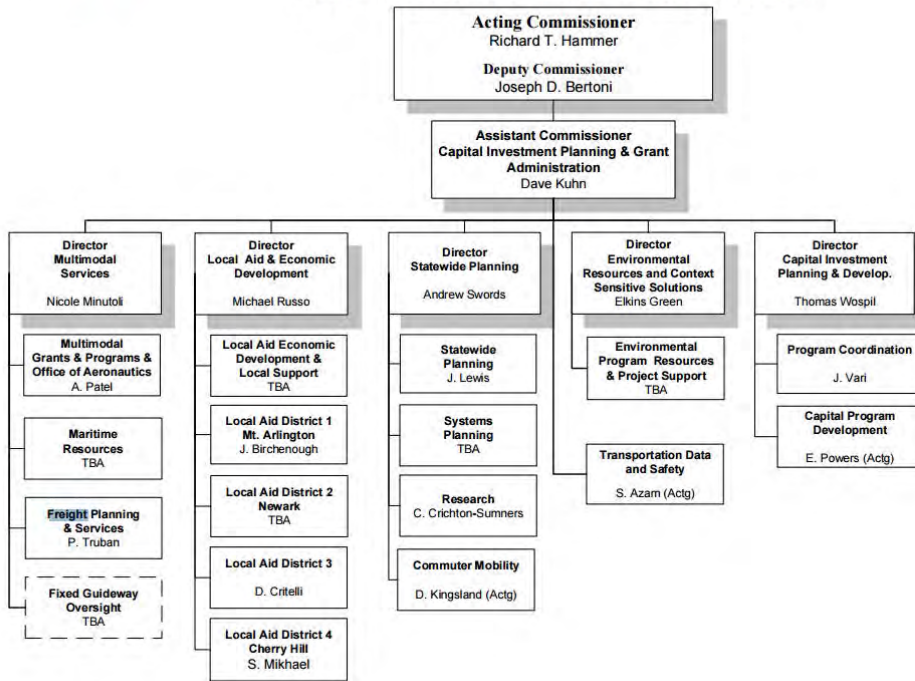

The New York DOT 2015 organizational chart also reflects a more prominent role for freight planning. As shown below, compared to 2009, the New York DOT added a new “Freight Rail Bureau” within its Office of Integrated Modal Services under the Policy and Planning Division.

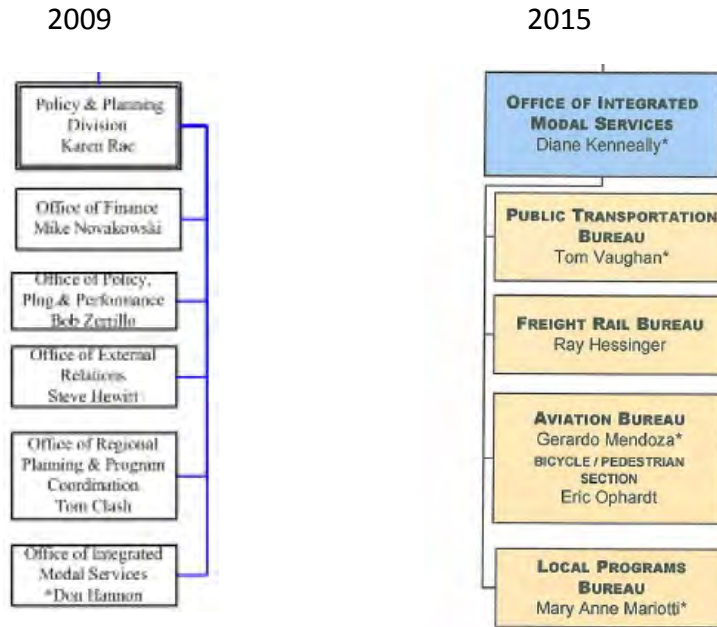

The Maine DOT addresses freight through its Office of Freight and Business Services, which signals via organizational structure and in name that the worlds of freight/supply chain logistics and business development are interrelated (Cambridge Systematics Inc, 2014). Other state DOTs like Texas did not feature freight as a priority on organizational charts, but other aspects of their planning documentation demonstrated a business-facing approach to freight planning and policy that represent approaches that public- and private-sector leaders may consider as they develop new freight efficiency initiatives (Texas Department of Transportation, 2016).

Organizational structures and the internal freight priorities of state DOTs are critical, but so too are the modes of engagement used to gain comprehensive feedback from every stakeholder in the statewide supply chain. This outreach component includes strategic messaging, public information dissemination, public events, and in-person and online stakeholder engagement. To promote strategic statewide and interregional planning initiatives, public- and private-sector leaders must work together to address trends that have hindered such efforts for decades. Such trends include:

- decentralized planning efforts, the deregulation of the transportation sector;
- lack of coordination between local government leaders to plan for regional and statewide freight corridors; and
- failure to plan for inevitable conflicts between freight and commuter vehicles, transit operations as well as bicyclists and pedestrians.

On the most basic level, remedies for all of these above challenges will only be developed if civic coalitions of leaders from the public sector and the private sector find ways to make freight efficiency a top priority in the planning and policy stages of projects. Such agents of change correctly understand that if operational and technological innovations are to achieve their fullest potentials, planning and policy efforts must not only account for historical best

practices but also respond to projected increases in freight volume and related technological challenges and opportunities.

To facilitate a process that drives statewide and interregional freight planning in California, this white paper will identify best practices implemented in relevant states. Particular attention will be devoted to innovative examples of strategic planning and management of freight corridors in other states.

### **Statewide Freight Planning**

In order to implement coordinated strategic freight planning efforts throughout California, it is critical that key stakeholders within the supply-chain continuum are engaged in an integrated and ongoing discussion/planning effort. Such engagement will ensure that State leaders are developing freight policy that is as comprehensive and relevant as possible. The white paper research included a review of a wide range of state DOT freight plans and found that public engagement (beyond the legally required public comment review process) was a feature in every state freight plan. However, the methods used and the degree to which state DOTs engaged the business communities affiliated with the state supply chain varied. Given their populations, ports, and blend of urban, suburban, and rural realities similar to California, the review focused on the Florida and Texas plans as useful comparisons for the development of a new freight optimization initiative in this state.

The Florida Department of Transportation's 2013 Freight Mobility and Trade Plan (FMTP) provides a valuable approach to broad-based supply-chain engagement. From the outset, the FMTP seeks to "develop a collaborative and transparent project prioritization process to match funding for short-term and long-term requirements to ensure maximum return on investment (ROI)" (Florida Department of Transportation [FDOT], 2013, p.2).

A clear strength of the Florida plan is its strategic engagement and messaging efforts to target the state's supply-chain community. This mode of outreach is worth highlighting as a best practice given that freight planning requires more coordination than other modes of transportation. This focus on supply-chain outreach was evident in Florida's FMTP and its related executive summary, which are very clearly designed to be accessible for policy makers and the general public. "Well over 750 members from Florida's private businesses and agency partners were involved in the process. Participation was all encompassing, ranging from local community planners and freight users, to business leaders, and even the Honorable Rick Scott, Governor of the State of Florida," (FDOT, 2013, p.13). According to the FMTP, outreach efforts focused on:

- lack of workforce technical skills in logistics;
- freight flow imbalances;
- need for greater efficient intermodal infrastructure;
- expanding energy sources; and
- need for better integration among transportation, trade, and energy.

Those abovementioned focuses were addressed in "five stages of direct engagement," which were titled: Regional Listening Forums; the 1st Florida Freight Leadership Forum; Business Forum I: Scenario Planning; Business Forum II: Plan Development; and Business Forum III: Plan



Review” (FDOT, 2013, p.11). Beyond the stages of engagement that informed that creation of the FMTP, Florida leaders emphasized that outreach would continue after the completion of the initial plan. The FMTP authors described the need for a “dynamic document that will be updated as needed, and will demonstrate that, when all stakeholders communicate and collaborate, maximum effort can be energized to propel Florida forward as the nation’s freight leader” (FDOT, 2013, p.2).

The ongoing outreach methods outlined in the Florida FMTP are useful touchstones for future California outreach. “Following an industry participation approach, rather than a government-only focus, better reflects the needs of freight stakeholders, allows the state to be more proactive and responsive, and streamlines freight investments. This collaborative process provides venues and opportunities for significant interaction with those who utilize, provide, and plan for the freight transportation system” (FDOT, 2013, p.12).

The Florida FMTP offers a valuable perspective on the importance of strategic messaging and supply-chain stakeholder engagement. Given that freight planning and policy is more complicated and less discussed than other modes of transportation in states across the nation, communications and public awareness campaigns are critical elements in any attempt to make interregional and statewide freight planning efforts a top priority. Further, strategic and unified messaging campaigns can also serve as a means to offer a consistent freight narrative to local decision makers who largely determine land-use decisions that impact, for better or worse, the fate of interregional and statewide planning efforts. Local elected officials often view the regulations from various state agencies as disparate and unrelated. The State of California could greatly enhance its outreach and communication efforts with local decision makers if leaders in the California State Transportation Agency, the California Environmental Protection Agency, the Natural Resources Agency, the California Air Resources Board, the California Department of Transportation, the California Energy Commission, and the Governor’s Office of Business and Economic Development found ways to articulate a consistent and integrated freight narrative. Said another way, the July 2016 integrated action plan called for in Gov. Jerry Brown’s executive order will be far more effective if it calls upon leaders in agencies throughout the State of California to reinforce a consistently strategic message about the importance of freight to the State’s well-being.

For the reasons just stated, Florida’s FMTP is a valuable point of reference for any state leader looking to develop a comprehensive stakeholder outreach campaign and consistent messaging strategy to promote more effective statewide freight planning efforts. For California’s purposes, it is worth noting that the Florida plan does not make the environmental and community impacts of freight movement as high a priority as is called for in Gov. Brown’s executive order. However, incorporating such environmental targets into an integrated California freight plan are feasible if those considerations are identified as top priorities upfront in the process.

It is also important to note that Florida is not the only state to employ such a comprehensive outreach strategy to supply-chain stakeholders. Although more planning driven than the Florida plan, the Texas Department of Transportation (TxDOT) Texas Freight Mobility Plan offers another very recent and instructive example of an industry-facing approach to stakeholder engagement. In both cases, the Florida and Texas plans demonstrate how strategic engagement

and targeted messaging are effective tools for encouraging and maintaining industry involvement and public awareness, which is essential if freight is going to be elevated to a top-tier priority in statewide planning efforts moving forward.

The Texas plan emphasizes the value of institutional coordination with calls for:

- increased collaboration with neighboring states to ensure a seamless transition of the system across state lines;
- collaboration and partnerships between public and private sectors ... needed to better align planning timelines, and improve project development processes; and
- improved collaboration and coordination with federal and state agencies, local governments, and MPOs is necessary to leverage infrastructure improvements, and increase support for freight issues (Texas Department of Transportation[TxDOT] , 2016, p.4).

TxDOT's proactive engagement with "state and federal agencies, MPOs, local governments, private sector entities such as railroads and ports, and other organizations" (TxDOT, 2016, p.217) represents a model practice for states looking to develop their own freight optimization efforts. As with most states and in response to MAP-21 guidance, the Texas Transportation Commission established the Texas Freight Advisory Committee (TxFAC) in January 2013 as part of the development of its freight plan. TxFAC members included "private-sector business leaders, modal representatives and elected officials," (TxDOT, 2016, p.197), who were responsible for, in part:

- Promoting the logistics industry and freight movement needs to enhance Texas' economic development.
- Educating the public and elected officials on how freight is directly tied to the economy (TxDOT, 2016, p.197).

Similar to the Florida freight plan, the Texas plan drew insights from a series of "listening sessions" that were "designed to engage a cross section of public- and private-sector freight stakeholders in urban, suburban and rural communities across Texas with the goal of incorporating local issues and concerns into the Freight Plan"(TxDOT, 2016, p. 198). TxDOT also solicited input from commercial vehicle operators and motor carriers to ensure that perspectives from "front-line operators" were incorporated into the freight plan. "In September 2013, 1,195 commercial vehicle operator interviews were conducted by TxDOT representatives at 10 locations across Texas" (TxDOT, 2016, p.199). Those interviews provided TxDOT with insights on freight flow locations throughout the state. "The interviews also supported data analysis from previously conducted research and modeling as it relates to the origins and destinations of truck freight, equipment, cargo type and areas of congestion" (TxDOT, 2016, p.199). This knowledge helped the state analyze its supply chains by commodity (e.g. automotive, cotton, beef) and the plan presents each product's focused supply chain accompanied by its own process flow.

TxDOT also hosted a range of educational and public outreach events to engage and inform the public about the State's new emphasis on improving its supply chain efficiency. As a means of engaging "private-sector strategic visionaries, decision-makers, advocacy groups and business leaders in a forum conducive to maximizing private corporate-sector involvement" (TXDOT, 2016, p.200), TxDOT partnered with North America Strategy for Competitiveness to hold a summit that would help TxDOT identify:

- an ideal Texas multimodal freight transportation system in 2040;
- needs to enhance the state's growth and economic competitiveness; and
- other strategic initiatives (such as policies, projects and funding) to promote improvements in Texas' freight transportation system (TXDOT, 2016, p.200).

TxDOT also developed the website [www.MoveTexasFreight.com](http://www.MoveTexasFreight.com) as another method of outreach and engagement with stakeholders. TxDOT described the website as valuable in promoting two-way communication via the comment feature on the site. Overall, TxDOT reported that the site proved a valuable tool "as it enabled fast, convenient distribution of information to all stakeholders and allowed for input to be received outside of an in-person meeting" (TXDOT, 2016, p.201). TxDOT's practical assessment of the value of online stakeholder engagement should not be overlooked. Indeed, online and network-driven information technology are powerful tools state leaders can leverage to connect strategic stakeholders, inform the public about the importance of the supply chain, and convey a consistent message about freight optimization best practices that local leaders can implement within their local jurisdictions to promote interregional and statewide operability.

Another insightful aspect of the Texas freight plan is its insights drawn from not only external stakeholders but also internal TxDOT and Texas Department Motor Vehicles staffers. This internal review "included staff from planning, aviation, rail, traffic and safety, maritime, toll operations, design, construction, bridge, state legislative affairs, federal affairs, and international relations" (TXDOT, 2016, p.201). The stated goals for the internal review were to:

- open the lines of communication among different divisions and staff members;
- build advocacy for integrating freight issues throughout TxDOT;
- highlight process improvements to enhance the integration of freight within TxDOT;
- improve, integrate and institutionalize freight planning within TxDOT and provide informational support to the TxFAC; and
- develop a structure to describe how freight planning activities fit within existing TxDOT planning(TXDOT, 2016, p.201).

Other TxDOT public engagement efforts included speaking engagements with a range of economic development, transportation, and metropolitan planning organizations.

Beyond best practices in stakeholder outreach and public outreach, the Florida and Texas plans demonstrate the importance of one operative word: education. As previously stated, freight and the value of the supply chain has been misunderstood and undervalued on many levels for decades. The only way to elevate freight as a statewide priority is through the formation of public- and private-sector partnerships to implement public education initiatives that communicate the importance of freight in compelling ways that will lend themselves to

dissemination on social media networks as well as through academic channels that shape the development of new curriculum across the academic continuum. Only after local elected officials and business and community leaders understand ways to support rather than impede supply chain efficiency will comprehensive statewide and interregional freight planning efforts be possible.

A final note about stakeholder engagement: dynamic networks of business, government, academic, and community leaders are brought together to create freight plans but are not often engaged in follow up activities. Given the rise of enterprise resource planning software platforms, these networks may more easily be maintained and cultivated for future initiatives seeking further freight/supply chain innovations.

## **Theme 2: Truck Routes and Integrated Corridor Management As Examples Of Statewide Planning**

Establishing interregional and statewide truck routes is a key step for not only making goods movement throughout California more efficient, but also in reducing negative impacts on local communities. The Planning and Policy white paper team reviewed a range of statewide and interregional truck route planning efforts and identified some common themes. The first obvious point is that leaders in transportation understand that statewide freight efficiency will not be possible until local jurisdictions throughout California are able to coordinate planning efforts in such a way that accommodates truck routes that improve efficiency at every stage in the supply chain—from pick-up to last-mile delivery.

As established earlier in this paper, statewide and policy efforts require a consistent outreach narrative paired with robust stakeholder engagement. The white paper team reviewed a range of statewide planning documents from relevant state DOTs to identify best practices to inform California’s freight efficiency efforts. That process revealed that a range of statewide and interregional truck route and integrated corridor planning efforts have been conducted in California and other states over the last decade. However, large-scale implementation has not yet occurred.

The National Freight Strategic Plan offers a basic rationale for the value of truck route planning:

An effective way for local governments to mitigate adverse community impacts is to preclude them from occurring in the first place. At the local level, this can often be accomplished through informed land-use decisions and communication with the affected communities. If local land uses, including residential demographics, are well understood and mapped, placement of freight and non-freight facilities can be done with allowances for appropriate buffer zones and freight routes. This effort necessarily requires a look into the future. Planning today for the inclusion of future freight movement and its interaction with population growth in urban areas can lead to far fewer adverse impacts to local residents and the environment. As noted previously, however, local government decisions to re-zone land are often made without information about current freight activity and needs, much less future freight traffic flows or supply chain requirements. Gaining information of this type will in almost all cases require coordination with MPO, State, and national-level forecasts (USDOT, 2015, p. 64).

In the circulation element of its General Plan, the City of Arroyo Grande, California, included a simple declarative sentence: “Truck routes should coordinate with County and adjoining cities

designated routes and avoid traversing residential areas” (City of Arroyo Grande). Prosaic as it may seem, inclusion of this sentence signals a commitment to mitigating adverse impacts of truck movements in Arroyo Grande and an awareness that a “municipal truck route network should be coordinated with neighboring jurisdictions to avoid areas containing sensitive land uses” (Federal Highway Administration [FHWA], 2012, p.56). If every municipal General Plan in California included language that highlighted the value of truck trip coordination in local planning efforts, it would create an environment in California that promoted statewide and interregional planning efforts. This notion is reinforced with the emphasis placed on freight education in the first portion of this white paper and is an important point to foreground in the discussion of any truck route implementation.

One very recent attempt by California policy makers to promote the development of a statewide truck route was presented in California Assembly Bill (AB) 2432. Introduced on February 19, 2016, AB 2432 called for Caltrans to “prepare an inventory of all state and locally designated truck routes and services” that would be published in a “statewide Truck Route Network” website. AB 2432 also called for the preparation of “a plan and schedule for addressing all inefficiencies and truck transportation network gaps, including an estimate of the annual cost and the total cost of carrying out the plan.” Such a website and related plan to address gaps and inefficiencies in the current “patchwork of truck routes throughout the state” could serve as a valuable tool to convene local decision makers and industry stakeholders to establish regional and statewide truck routes that would improve the efficiency and sustainability of California’s supply chain.

Caltrans like other state DOTs has access to archives of past and current local truck routes throughout the state—as presented here:

<http://www.dot.ca.gov/hq/traffops/trucks/truckmap/local-truck-routes.htm>. The challenge is how to coordinate and connect.

One way to engage local leaders to take on regional and statewide planning efforts is to begin with outreach efforts that directly relate to transportation concerns in their own local areas. To better understand traffic congestion and its effects on the efficiency of freight transportation, the American Transportation Research Institute (ATRI) and the Federal Highway Administration (FHWA) developed an online form (see below) that local stakeholders from across the country can use to submit information about bottlenecks within their respective regions. The online form serves as a valuable method to solicit information pertaining to traffic congestion. An enhanced version of that tool could prove beneficial in establishing regional planning coalitions. For example, if local decision makers from Pasadena and Burbank, California submitted information to the state concerning a certain bottleneck on the bordering Glendale area, those local leaders could be engaged by state leaders to support a regional planning initiative to address that bottleneck. This tool could aid in promoting the improvement of state and local planning efforts.



Please submit details regarding locations that you feel should be monitored by the Freight Performance Measures program using the form below. Thank you

	City	State	Highway(s)	Description
Location 1	<input type="text"/>	Select: ▾	<input type="text"/>	<input type="text"/>
Location 2	<input type="text"/>	Select: ▾	<input type="text"/>	<input type="text"/>
Location 3	<input type="text"/>	Select: ▾	<input type="text"/>	<input type="text"/>

[Submit Information>>](#)

Another good example of local stakeholder engagement is reflected in the Washington State Department of Transportation’s freight advisories, which alert stakeholders throughout the state about important weather and safety warnings that impact the movement of goods. Here is an example:

**WSDOT ALERT:** SR 14 closed in Klickitat County due to tanker truck crash and fuel spill

**DATE/TIME:** Feb. 28, 2016 2:45 p.m.

**DESCRIPTION:** Both directions of SR 14 are closed due to a rolled over tanker truck and fuel spill near Roosevelt, (milepost 133.5). Westbound SR 14 is closed at SR 221 in Paterson, and eastbound is closed at US 97 near Maryhill. It will take crews approximately 8 hours to clean up several thousand gallons of spilled fuel and remove the vehicle. The Washington State Patrol and the Washington State Department of Transportation are on-scene. Drivers should avoid the area and add extra time for their trips.

**LOCATION:** SR 14, Roosevelt, Klickitat County

**START:** Feb. 28, 2016 11:34 a.m.

**Estimated END:** Feb. 28, 2016 11 p.m.

Both the Freight Performance Measures and the Washington State DOT freight advisories reflect a service-driven approach to stakeholder engagement. By directly appealing to the local and operational needs of stakeholders, state transportation leaders are able to gather data about engaged local leaders and supply chain stakeholders. Using that data, state leaders can conduct outreach efforts with locally invested public- and private-sector leaders to form strategic coalitions and promote regional and statewide planning efforts.

Following are some examples of models from other states with lessons for California.

### **GA Truck Lane Needs Study**

In 2006, the Georgia Department of Transportation (GDOT) conducted a “Truck Lane Needs Identification Study” to determine the feasibility of “a truck-only lane system in Georgia and to identify locations where truck only lanes can be feasible from the standpoints of engineering,

operations, and economics” (Georgia Department of Transportation[GDOT], 2006, p.1) The GDOT study derived findings from a meeting with a range of stakeholders from FHWA, GDOT, Florida DOT, Norfolk Southern, the GA Chamber of Commerce, GA Port Authorities, GA Power Company, GA State Road and Tollway Authority, GA Motor Trucking Association, among other stakeholders. During that meeting GDOT staffers facilitated a breakout session where one public-sector and one private-sector group each responded to the same set of questions regarding the implementation of a truck-only lane system in Georgia. The questions are useful points of reference for California leaders seeking to conduct stakeholder outreach to support the development of interregional and statewide truck routes. The GDOT breakout session aligned with the basic outreach approach noted in the Florida and Texas DOT plans with balanced outreach to both public- and private sector leaders. The value of that balance is illustrated in the response to this question:

Besides traffic congestion, what are the most significant issues impacting truck travel in Georgia?

Public-sector representatives gave the following responses:

- Reliability
- Enforcement
- Safety
- Air Quality
- Comfort Level
- Reduces capacity
- Land Use

Private-sector representatives gave some responses that overlapped with the public-sector group, but they also raised other issues, including:

- Reliability/unreliability of travel times
- Interactions between cars and trucks
- Public awareness of truck issues (i.e. how long it takes to stop a truck, etc.)
- Safety – mixed travel streams
- Fuel costs
- Role of “just in time” delivery systems
- Congestion – impacts on shippers’ business decisions
- Trucks desire continuous through movement with as little delay as possible
- Understanding the truck movements (local vs. through/long haul)
- Permitted moves (i.e. oversize loads) (GDOT, 2006, p.3).

The public- and private-sector groups also provided instructive responses to this question:

What factors should be considered in determining whether truck only lanes should be built in Georgia?

Public-sector representative responses:

- What kind? Segments? Systems?

- Access and configuration
- Financing
- Truck volumes
- Congestion
- Truck generators
- Pricing
- Demand forecasts
- Vehicle classifications
- Time-of-day traffic/truck volumes
- Safety
- Costs/benefits
- Policies
- Education
- Freight mode choice
- Economics of freight
- Intermodal connectivity
- Needs of shippers/receivers
- Hours of service regulation
- Needs of consumers
- Roadway design
- Infrastructure maintenance
- Urban circumferentials

Public-sector representative responses:

- Customers with no inventory (they rely on timely truck deliveries)
- Strategic Industry Task Force
- Logistics are critical
- Incentives to attract business
- Infrastructure costs (related/leading to load limits that restrict route choice)
- Requirement for large truck pools – impacting local land uses
- Larger local markets (within large urban areas like Atlanta)
- Population growth
- Cost/who pays?
- Recognize truck issues in project design phase – design considerations that are
- appropriate for trucks
- Express lanes for through trucks
- Dispatching capacity – assigning traffic to lanes (like railroads control their operations)
- Incident management
- Separate cars and trucks
- Safety
- Traffic volumes
- Congestion



- Need for better access in urban areas
- Rural areas as TOL candidate areas (due to right-of-way availability and easy maintenance) (GDOT, 2006,p. 3-4)

The questions used by the Georgia DOT to gain broad-based stakeholder perspective on the implementation of truck-only lane systems serve as practical templates of inquiry for California-based engagement with public- and private-sector supply-chain stakeholders. Other Georgia DOT questions worth reviewing are listed below. While reviewing these questions, it is valuable to consider how these questions could be adapted to relate more directly to the implementation of interregional and statewide truck routes in California.

Who should be involved in developing public policies on truck only lanes?

- *California: What public- and private-sector stakeholders should be involved in developing interregional and statewide truck routes in California?*

How familiar are you with the concept of Truck Only Lanes?

- *California: How familiar are you with the concepts of interregional and statewide truck routes?*

Besides traffic congestion, what do you see as the three greatest transportation issues or concerns regarding Truck Only Lanes?

- *California: Besides traffic congestion, what do you see as the three greatest transportation issues or concerns regarding interregional and statewide truck routes?*

What transportation corridors and areas of the State are of most interest to you in terms of truck and freight-related traffic?

- *California: no adaptation necessary.*

Do you believe Truck Only Lanes are needed in Georgia? Where? Why?

- *California: Do you believe interregional and statewide truck routes are needed in CA? Where? Why?*

Has your business been impacted by truck-related accidents?

- *California: no adaptation necessary.*

Other difficulty in transporting goods and/or services on Georgia's interstate highways and other important routes?

- *California: Other difficulty in transporting goods and/or services on California's interstate highways and other important routes?*

Overall, how efficiently do you think Georgia's freight mobility is?

- *California: Overall, how efficiently do you think California's freight mobility is?*

What advice do you have for the project team for exploring the feasibility of truck only lanes in Georgia?

- *California: What advice do you have for the project team for exploring the feasibility of interregional and statewide truck routes in California?*

It is a self-evident statement, the insight is sometimes lost: Comprehensive and inclusive stakeholder engagement leads to comprehensive and inclusive policy formation and related planning development. That sentiment was reinforced by the exit comments of the GDOT breakout session. When asked for feedback and ways to improve stakeholder engagement, respondents stated that GDOT must find new ways “to involve more industry representatives at the stakeholder meetings, especially national shippers and carriers” (GDOT, 2006, p.8).

### Colorado RoadX

The Colorado DOT’s RoadX initiative strives to guide the integration of technology into Colorado’s transportation system with a positive impact on corridor-wide truck traffic. Colorado acknowledges the potential of technology as a means to achieve social prosperity. As such, CDOT is investing \$20 million into both starting funds for RoadX and congestion and safety optimization technologies. Cooperation and collaboration are both critical with projects of this scope. CDOT recognizes this as they begin convening the RoadX InnoVisers Council comprised of local and international leaders, advisors, and innovators from both the public and private sectors (Colorado Department of Transportation[CDOT], 2014).

Projects under RoadX include:

**Interoperable Data Platform:** Deploy a web-based, open source safety, traffic and transportation system data platform capable of communicating with a diverse collection of drivers, cellular/mobile applications, and connected and autonomous vehicles to deliver critical real-time, actionable information and safety voice alerts such as multi-vehicle pileups, rock falls, avalanche slides, white-out/fog-out low visibility, wrong-way drivers, runaway trucks, stopped vehicles, incident advisory, icy roads, emergency vehicles, curve speed warnings, intersection hazards, work zone warnings, sun glare warnings.

**I-70 Connected Vehicle Pilot Deployment:** Maximize safety and mobility on the I-70 mountainous corridor through probe data collection, vehicle-to-infrastructure (V2I) communication, and related decision support analysis to enable real time traffic management and traveler information and safety applications.

**Technology Planning Process:** Develop NEPA/environmental evaluation process that effectively includes technology and operation innovations as a significant part of the alternatives analysis. For projects already past the environmental evaluation process, develop a “RoadX” clearance process to ensure all alternatives are incorporated as a project moves into design (CDOT, 2014).

### Illinois Truck Route Grant Program

The Illinois Truck Access Route Program (TARP) is intended to help local governments upgrade roads to accommodate 80,000 pound truck loads. Additionally, the routes are intended to provide access to points for both loading and unloading and to facilities for food, fuel truck repair and driver rest. Any projects under the program must connect to a truck route and end at another truck route or truck generator.

The TARP annual appropriation is \$7.0 million. The program will provide \$45,000 per lane mile and \$22,000 per eligible intersection for selected projects. The state participation cannot exceed 50% of the total construction costs or \$900,000 (whichever is less). Additionally, if the project is done in conjunction with a state Economic Development Project (EDP), the project will be capped at \$150,000. Each fall the Illinois DOT solicits local projects that can be constructed during the upcoming fiscal year (Truck Access Route Program, Illinois Department of Transportation, 2015)

### **Identifying and Prototyping Integrated Corridor Management Strategies for Application in Virginia**

The Virginia Center for Transportation Innovation and Research sponsored a study that sought to identify and analyze current issues with the state's corridor management practices as a means to address issues relating to highway congestion and its negative impacts on urban transportation. Several subsystems comprise a greater corridor management system such as arterial signal control systems and transit systems. The study attributes institutional barriers and traditional practices as causes for the subsystems operating in isolation from one another. Therefore, the goal would be to develop a system that coordinates and forces subsystems to work collaboratively (otherwise known as Integrated Corridor Management (Asare & Smith, 2014).

The study was broken up into eight main tasks:

1. Literature review on ICM
2. Selection of site to test prototype ICM strategies
3. Identification of best practices and potential ICM strategies
4. Development of ICM evaluation methodology
5. Development and validation of simulation network
6. Evaluation of proposed ICM strategies
7. Analysis of results
8. Development of recommendations (Center for Transportation ).

Three critical success factors were identified that demonstrate the potential for ICM application through eight of Virginia's "pioneer" states (sponsored by the USDOT ICM Initiative):

1. A robust Intelligent Transportation Systems (ITS) infrastructure.
2. The need for Stakeholder partnerships which work toward the development of institutional frameworks within which the ICM will be implemented and operated.
3. The need to adopt standard and protocols through which information will be disseminated.

An experiment was also conducted to further explore the effectiveness of ICM. The experiment involved prototyping several ICM strategies within a simulated environment using a segment of the I-95/I-395 corridor as a test bed. Results of simulation revealed:

- Corridor person flow per hour could be potentially increased by 14% under non-incident traffic conditions, compared to 38% during incident conditions.
- The I-95 general purpose lanes could experience (in terms of average travel time) a reduction of 48% and 58% under non-incident and incident traffic conditions respectively.

- Average travel times on the primary arterial (U.S. 1N) improved by 29% under both non-incident and incident conditions.
- Fuel usage was reduced by 34% and 33% during non-incident and incident conditions respectively.
- Benefit cost ratios of 4:1 and 6:1 were obtained for non-incident and incident conditions respectively (Asare & Smith, 2014).

Overall, the study concluded that the most promising ICM strategies Virginia could implement were: variable speed limits, increased transit and parking capacities, HOV bypass lanes, and HOV/HOT lanes.

## Conclusion

After reviewing a range of state DOT organizational charts and related outreach methods used to engage strategic stakeholder groups, the Planning and Policy team has established recommendations to inform the development of the California Sustainable Freight Action Plan.

The first series of recommendations relates to criteria that authors of the California Sustainable Freight Action Plan can use to benchmark the adoption of best practices related to elevating freight as a statewide priority within the organizational structure of state DOTs. Toward that end, the following best practices should be considered:

1. The freight functions within a state DOT should be prominently featured on organizational charts so that members of the public can easily identify which division carries out those functions. That organizational chart should also state the name of the director for the freight division. Presenting freight as its own transportation division with a clear leadership structure sends a clear message that goods movement is a statewide priority. Signaling that freight functions are an organizational priority will also help with related public outreach as well as stakeholder engagement with leaders in the state and national supply chain.
2. Given that freight functions require constant engagement with members from the goods movement industry, state DOT leadership should also consider housing freight functions within a business services division of the organization. Alternatively, DOT leadership can house freight functions within more traditional transportation organizational structures but create a business services subdivision. State DOTs can also build business-facing approaches into other related planning documentation to better engage industry leaders.

The second series of recommendations relates to outreach best practices. Within goods movement and logistics circles, it is understood that freight planning and policy is more complicated and less discussed than other modes of transportation. However, this notion is largely not understood by local decision makers and members of the general public. This is why communications and public awareness campaigns are critical elements in any attempt to make interregional and statewide freight planning efforts a top priority. It is essential that public- and private-sector leaders communicate the invaluable role that the goods movement industry plays in the domestic economy and, more importantly, in getting essential food and goods to communities throughout the nation. Failure to communicate this message makes it more likely

that local elected officials and the constituents they serve will take for granted the value of the local, state, and national supply chain while complaining about negative effects related to what is ultimately a failure to make freight planning and policy a priority.

This White Paper recommends the following outreach best practices:

1. Develop and conduct strategic and unified messaging campaigns to offer a consistent freight narrative to local decision makers who largely determine land-use decisions that determine interregional and statewide planning efforts.
2. Engage local leaders to take on regional and statewide planning efforts by using outreach methods that directly relate to transportation concerns in their own local areas. One simple and cost-effective way to conduct such outreach is to use an online form that local decision makers can use to report bottlenecks in their respective region of influence. Local decision makers who submit information to the state concerning bottlenecks could then be engaged by state leaders to support a regional planning initiative to mitigate congestion related to how that bottleneck connects to the larger statewide transportation network. Using that data, state leaders can conduct outreach efforts with locally invested public- and private-sector leaders to form strategic coalitions and promote regional and statewide planning efforts. Data gathered from this online form of engagement could also be used to develop regional and statewide plans to address gaps and inefficiencies in the State freight transportation network.

## References

- Asare, S. K., & Smith, B. L. (2014). *Identifying and Prototyping Integrated Corridor Management (ICM) Strategies for Application in Virginia*. Charlottesville, VA: Virginia Center for Transportation Innovation and Research.
- California Legislature 2015-2016 Regular Session. (2016, February 19). *AB-2432 Designated state and local truck routes and services*. Retrieved from California Legislative Information:  
[http://leginfo.ca.gov/faces/billNavClient.xhtml?bill\\_id=201520160AB2432](http://leginfo.ca.gov/faces/billNavClient.xhtml?bill_id=201520160AB2432)
- Cambridge Systematics Inc. (2014). *Maine Integrated Freight Strategy Final Report*. Maine Department of Transportation.
- Center for Transportation . (n.d.). Retrieved from University of Virginia :  
<http://www.cts.virginia.edu/identifying-and-prototyping-integrated-corridor-management-icm-strategies-for-application-in-virginia/>
- City of Arroyo Grande. (n.d.). *Circulation Element*. Retrieved from Document Center:  
<http://www.arroyo grande.org/DocumentCenter/View/472>
- Colorado Department of Transportation. (2014). *Colorado's Vision: RoadX-Where Transportation and Technology Intersect*.
- Federal Highway Administration. (2012). *FHWA Freight and Land Use Handbook*. U.S. Department of Transportation .
- Florida Department of Transportation. (2013). *Freight Mobility and Trade Plan*.
- Georgia Department of Transportation. (2006). *Summary of Statewide Advisory Committee Meeting*. Atlanta.
- Illinois Department of Transportation. (2015). *Economic Development Program*.
- Texas Department of Transportation. (2016). *Texas Freight Mobility Plan: Executive Summary. Truck Access Route Program (TARP)*. (n.d.). Retrieved from Illinois Department of Transportation: <http://www.idot.illinois.gov/transportation-system/local-transportation-partners/county-engineers-and-local-public-agencies/funding-opportunities/truck-access-route-program>
- U.S. Department of Transportation. (2015). *National Freight Strategic Plan*.

# INFORMATION TECHNOLOGY

March 2016

A White Paper from the Freight Efficiency  
Strategies Development Group

**Lead Author: Genevieve Guiliano**, University of Southern California

**Working Group Members: Matthew Barth**, University of California, Riverside; **Kerry Cartwright**, Port of Los Angeles; **Christina Casgar**, San Diego Association of Governments; **Mike Christensen**, Port of Long Beach; **James Jack**, Coalition for Responsible Transportation; **David Libatique**, Port of Los Angeles; and **Chris Shimoda**, California Trucking Association



National Center  
for Sustainable  
Transportation



## **About the Freight Efficiency Strategies Development Group**

In July 2015, Governor Jerry Brown issued Executive Order B-32-15, directing several state agencies to work together in developing an integrated action plan that will “establish clear targets to improve freight efficiency, transition to zero-emission technologies, and increase competitiveness of California’s freight system” and that the plan should “identify state policies, programs, and investments to achieve these targets”. In response, an interagency group was formed to oversee the development of the California Sustainable Freight Action Plan (CSFAP). Members of the interagency group include the California Air Resources Board, the California Department of Transportation (Caltrans), the California Energy Commission (CEC), and the Governor’s Office of Business and Economic Development (GO-Biz). As part of developing the plan, the interagency group has solicited feedback from a broad range of stakeholders through a variety of engagement activities and outreach efforts. A component of this engagement was the development of the Freight Efficiency Strategies Development Group (FESDG) made up of freight experts from academia, industry, and government. The purpose and main task of this group was to produce a series of white papers that identify promising strategies for increasing the efficiency of the freight system. A series of six papers were developed over the course of six months. Each paper focuses on a specific theme for increasing freight efficiency within the larger freight system.

## **About the National Center for Sustainable Transportation**

The National Center for Sustainable Transportation is a consortium of leading universities committed to advancing an environmentally sustainable transportation system through cutting-edge research, direct policy engagement, and education of our future leaders. Consortium members include: University of California, Davis; University of California, Riverside; University of Southern California; California State University, Long Beach; Georgia Institute of Technology; and University of Vermont. More information can be found at: [ncst.ucdavis.edu](http://ncst.ucdavis.edu).

## **Disclaimer**

The contents of this report reflect the views of the authors, who are responsible for the facts and the accuracy of the information presented herein. This document is disseminated under the sponsorship of the United States Department of Transportation’s University Transportation Centers program, in the interest of information exchange. The U.S. Government and the State of California assumes no liability for the contents or use thereof. Nor does the content necessarily reflect the official views or policies of the U.S. Government and the State of California. This report does not constitute a standard, specification, or regulation.

## **Acknowledgments**

This study was funded by a grant from the National Center for Sustainable Transportation (NCST), supported by USDOT and Caltrans through the University Transportation Centers program. The authors would like to thank the NCST, USDOT, and Caltrans for their support of university-based research in transportation, and especially for the funding provided in support of this project. The IT Group is grateful for the assistance of the following USC students who



conducted research and provided information in the development of this White Paper: Ling Feng (Master of Planning), Nathan Hutson (PhD planning), Sanggyun Kang (PhD planning), Arnold Valdez (Master of Planning), Quan Yuan (PhD planning), and Wenhao Zheng (Master of Planning). Matt Barth was assisted by Kanok Boriboonsomsin (Associate Research Engineer, UC Riverside). Christina Casgar and Scott Strelecki (SANDAG) provided information on the Border Region ITS Strategy.

[page left intentionally blank]

# TABLE OF CONTENTS

- ABSTRACT..... iv
- INTRODUCTION ..... 1
  - Theme 1: Information Problems in the Goods Movement Supply Chain ..... 1
  - Theme 2: Information Problems in Statewide Trucking ..... 3
- ACCELERATE AND EXPAND FRATIS PROGRAM..... 4
  - Statement of the Problem ..... 4
  - Description ..... 4
  - Expected Benefits ..... 7
  - Expected Costs ..... 8
  - Role of the Public Sector ..... 9
  - Implementation Challenges ..... 9
  - Measuring Success ..... 10
- SYSTEM-WIDE APPOINTMENTS AT MAJOR SEAPORTS ..... 13
  - Statement of the Problem ..... 13
  - Description ..... 13
  - Expected Benefits ..... 15
  - Expected Costs ..... 18
  - Role of the Public Sector ..... 18
  - Implementation Challenges ..... 19
  - Measuring success ..... 20
- LOAD TRACKING SYSTEM ..... 21
  - Statement of the Problem ..... 21
  - Description of the Strategy ..... 22
  - Expected Benefits ..... 22
  - Expected Costs ..... 23
  - Role of the Public Sector ..... 24
  - Implementation Challenges ..... 24
  - Measuring Success ..... 26
- STATEWIDE SMART PARKING..... 26
  - Statement of the Problem ..... 26
  - Description ..... 27
  - Expected Benefits ..... 29
  - Expected Costs ..... 30
  - Role of the Public Sector ..... 30
  - Implementation Challenges ..... 30
  - Measuring Success ..... 31
- PUSH FREIGHT TRAFFIC INFORMATION SYSTEM ..... 32
  - Statement of the Problem ..... 32
  - Description of the Strategy ..... 32

Expected Benefits .....	34
Expected Costs .....	35
Role of the Public Sector .....	35
Implementation Challenges .....	35
Measuring Success .....	36
<b>STATEWIDE FREIGHT INFORMATION PLATFORM .....</b>	<b>36</b>
Statement of the Problem .....	36
Description .....	37
Role of the Public Sector .....	38
Expected Benefits .....	38
Expected Costs .....	38
Challenges .....	38
Measuring Success .....	39
<b>BORDER REGION ITS STRATEGY .....</b>	<b>39</b>
Statement of the Problem .....	39
Description .....	40
Expected Benefits .....	41
Expected Costs .....	42
Role of the Public Sector .....	42
Implementation Challenges .....	43
Measuring Success .....	44
<b>FREIGHT-FOCUSED TRAFFIC MANAGEMENT .....</b>	<b>44</b>
Statement of the Problem .....	44
Description of the Strategy .....	45
Expected Benefits .....	47
Expected Costs .....	47
Role of the Public Sector .....	48
Implementation Challenges .....	48
Measuring Success .....	49
<b>CONCLUSIONS .....</b>	<b>49</b>
References .....	51
Appendix .....	59

# Efficiency Strategies Development Group: Information Technology

## ABSTRACT

This White Paper presents recommendations for using information technology solutions to increase the efficiency of California’s multimodal freight system. These recommendations resulted from a consensus based process by working group committee members. We address two problems: information problems in the goods movement supply chain, and information problems in statewide trucking. Regarding the goods movement supply chain, we recommend the following strategies: 1) accelerate and expand the FRATIS program; 2) implement ports-wide appointment systems at the state’s major ports; 3) develop and implement a transparent supply chain wide load tracking system. Regarding statewide trucking, we recommend the following strategies: 4) statewide smart parking system; 5) “push” freight information system; 6) statewide freight information platform; 7) border region ITS strategy; and 8) freight focused traffic management.

## INTRODUCTION

This White Paper presents recommendations for using information technology solutions to increase the efficiency of California’s multimodal freight system. We follow the Efficiency Strategies Development Group (EFDG) scope document, which states:

“This Think Tank will be focused on opportunities for Federal, State and local policies and the private sector to remove system-wide barriers to the efficient movement of freight.”

The IT Group framed the problem as one of delay. There can be delay due to 1) congestion on roads or at docks, 2) uncertainty of when a load can be delivered or picked up, where a parking place may be, etc., 3) queuing at weigh stations, borders, or terminal gates, 4) limited time windows for deliveries.

Typically, delays are due to a combination of institutional problems and/or information problems. An example of institutional-driven delay is road congestion. Road traffic demand is high during the day and low at night because most businesses do not operate at night. Local truck traffic is concentrated during daytime hours in part because deliveries are constrained to those hours, either by the businesses themselves or by local regulation. Examples of information problems include the uncertainties associated with when or where a load is ready for pickup or delivery, weight or other restrictions on local roads, or unanticipated road or bridge closures.

There are numerous barriers to reducing delay, some of which cannot be avoided. For example, despite the increased prevalence of flex time for certain employment categories, the typical workday schedule is not going away. Others can be avoided or at least mitigated through policy intervention, as in the example of smart parking systems that reduce the delay associated with finding a space. Our task is to identify barriers that can be addressed, and show how IT can be used to overcome them.

In accordance with the State’s goals of increased fuel efficiency and reduced GHG emissions, the IT Group focused on strategies that generate eco-efficiencies: freight system efficiency is improved while environmental benefits are achieved. We have organized our strategies around two themes: 1) Information problems in the goods movement supply chain, and 2) Information problems in statewide trucking.

### **Theme 1: Information Problems in the Goods Movement Supply Chain**

In the goods movement system, a major barrier is the lack of information and managing the flow of information flows across the supply chain. Supply chains are systems, but in most cases there is no system manager. Each part of the supply chain has limited information and/or may not receive information early enough in the process about the other parts, and each actor is optimizing their component independently. Examples abound: terminal operators may not

receive information on the incoming cargo sufficiently in advance of the vessel arriving; many BCOs have limited information on when their cargo may be available or may not be aware of where to obtain such information; the trucking community may not receive load information in a timely manner for various reasons, warehouses do not know exactly when the next load will arrive, etc. A system manager would optimize across the entire system, but such management requires information and cooperation.

A second problem is measurement and data. Different parts of the supply chain use different measures. For example, “turn time” for a trucker can sometimes include queuing at the gate, but more often only tracks time spent within the terminal. It also does not capture how truck delays impact the marine terminal operator (MTO). It follows that data on ‘turn time’ will be inconsistent and not comparable across terminals. Even within the same segment of the supply chain, firms may use different information systems that are incompatible, and as firms or public agencies invest in new technologies, they face problems in interfacing with legacy systems.

IT makes it much easier to collect and share information. Various types of sensing devices allow for passive collection of data (e.g. cellphone GPS traces, vehicle GPS traces, tracking of containers via sensors), making the data collection far more efficient. Real-time or near real-time data systems reduce uncertainty about traffic conditions, container location, or border delays. The potential benefits of IT systems compound as data sources and linkages increase (e.g. linking vessel, container, yard and chassis data, as in some of the newer terminal operations systems software), because information problems are typically at the interface of supply chain links.

We are seeing an explosion of proprietary tools to address information problems in the supply chain. From the early days of eModal to the many tools emerging today, there are more and more choices of management tools (e.g. truck assignment and routing software, inventory management systems), and more new tools to solve specific problems (e.g. empty container matching). This proliferation of proprietary tools, mostly focused on specific problems or segments of the supply chain, will continue. IT entrepreneurs have every incentive to create software that is targeted to a specific market and captures the customer.

However, it does not appear that there is an incentive to create the equivalent of “open source” systems, or interoperable systems. Open source could reduce profits, and interoperable systems could in the short run reduce competitive advantage. Nor do system users necessarily wish to share data. Nearly every participant in the supply chain is in intense competition, and some users may be concerned about the regulatory implications of data sharing. Thus, while these tools are increasing efficiency in all sorts of ways, it is not clear that the “system manager” ideal will be achieved simply by “letting the market work.”

The IT Group recommends three strategies for generating eco-efficiencies by reducing information problems in the supply chain:

1. Accelerate and expand the FRATIS program

2. Implement a system-wide appointments system at California's major seaport
3. Design a fully transparent tracking system across the supply chain

## **Theme 2: Information Problems in Statewide Trucking**

Given that the states have primary responsibility for the highway system and the interstate commerce that takes place on the system, it seems quite appropriate for the IT Group to examine potential efficiency improvements on the state highway system. Traffic congestion is a major source of delay. Absent major infrastructure investment, there are traffic management solutions, such as signal priority for trucks in heavy truck traffic corridors, or improved real-time information and routing systems. In addition, there are many sources of delay on the highway system, aside from recurrent traffic congestion:

- Weigh stations, inspection processes, permitting
- Limited availability of real-time accident/incident/event data
- Security-related delays at border crossings
- CV parking and facility shortages

IT could play a greater role in all the above problems. California has at least one "virtual weigh station" on I-80; it would be helpful to understand whether it has improved traffic conditions in the corridor, or improved weight compliance, and hence makes a case for broader implementation. There are other issues associated with special permits, and interstate traffic. For example, California is part of PrePass, but Oregon and Washington are not, so interstate truckers need two different permits to bypass weight stations amongst the three states.

In some ways, California is at the leading edge in real-time information, but some parts of the system have better access than others. One of the most advanced FRATIS (Freight Advanced Traveler Information System) demonstrations is taking place in Los Angeles. At the same time, California does not have an advanced freight traveler advisory system. Border crossing delays are a significant impediment to commerce, yet there is currently no program in place that is taking action to reduce these delays. Finally, the issue of truck parking and rest area provision is becoming more important as a result of both constantly increasing truck traffic and restricted hours of service requirements. California has one of the most severe truck parking shortages in the US.

The IT Group recommends five strategies for generating eco-efficiencies by reducing information problems in statewide trucking:

1. Develop and implement a statewide smart parking system and increase the supply of truck parking
2. Develop and implement a "push" freight traffic information system
3. Develop and implement a statewide freight information platform
4. Implement the Border Region ITS Strategy
5. Develop and implement freight priority traffic management in high volume truck corridors



The eight recommended strategies are discussed in the following sections of the White Paper.

## **ACCELERATE AND EXPAND FRATIS PROGRAM**

### **Statement of the Problem**

The Freight Advanced Traveler Information System (FRATIS) has been a successful and promising program for generating eco-efficiencies. Its success has been shown in recent demonstrations, and there will be increasing benefits with a further expansion of the program. According to Butler (2014), the lack of Freight Advanced Traveler Information has negative effects on both economic efficiency and environmental sustainability. The FRATIS Program can produce society-wide benefits including promoting efficient movement of freight transportation, planning of freight daily work activities and logistics management systems. It would also help improve the environment of neighboring communities and safety of the traveling public, as well as reduce energy consumption.

For different freight movement stakeholders, FRATIS can enhance communication, improve efficiencies and reduce costs. It can help trucking companies improve productivity and efficiency of the fleet, empower dispatchers with real-time information for faster and better decisions, generate near optimal trucks itinerary with real time information and provide dispatchers access to real time terminal waiting times and turn-times. With the information system, drivers will be able to navigate to their destinations and be rerouted in case of heavy traffic, incidents and congestion in their current route (Butler, 2014).

FRATIS can help Intermodal Facilities receive pre-notifications containing details for trucks coming to perform transactions in their facilities and real time notifications of trucks heading towards their facilities with estimated time of arrival. The notifications ahead of time would help the facilities reduce waiting time, turn-around time and unproductive pickups/drop-offs by enabling better container turns and reuse. With FRATIS, intermodal facilities are able to communicate directly with dispatchers to notify about terminal closures, incidents, or any other operational status in order to mitigate congestion in their facilities (Butler, 2014).

In terms of public benefits, FRATIS can help promote better transportation planning and policy, and improve air quality by reducing CO2 emissions and quality of life of the region. It provides a platform to support economic development in the region and contribute to better utilization of existing infrastructure and capacity. With more information about safer routes for trucking operations provided by FRATIS, local communities can effectively protect residents from truck-related accidents (Butler, 2014).

### **Description of the Strategy**

According to Figure 1 below, the FRATIS framework has three components: 1) data collection from different public and private sources, 2) FRATIS IT Toolkit used to pull and integrate data,

and 3) FRATIS data application to two basic application bundles and their value added versions. (Jensen et al., 2012).

The FRATIS system integrates data from multiple sources. Overseen by a regional public-private partnership, FRATIS will pull data from various sources using web services and/or application programming interfaces (API). Note that at this early stage, FRATIS is envisioned as a regional/urban system rather than a national one, due to the significant disparities between available ITS and freight data among regions. Data sources include Regional ITS data, truck movement data, intermodal terminal data and the future U.S. Department of Transportation (DOT) Connected Vehicle data (Jensen et al., 2012). Regional ITS data contains real-time freeway/arterial speeds and traffic volumes, incident data, truck parking locations and availability, and route restrictions. Truck movement data is from third parties such as truck speeds and position data from Global Positioning System (GPS) devices in trucks. Intermodal terminal data includes real-time queue lengths and container availability updates. The Future U.S. Department of Transportation (DOT) Connected Vehicle data includes data outputs expected from the U.S. DOT Connected Vehicle program, such as road-level weather information and probe data from Vehicle-to-Infrastructure and Vehicle-to-Vehicle technologies currently under development.

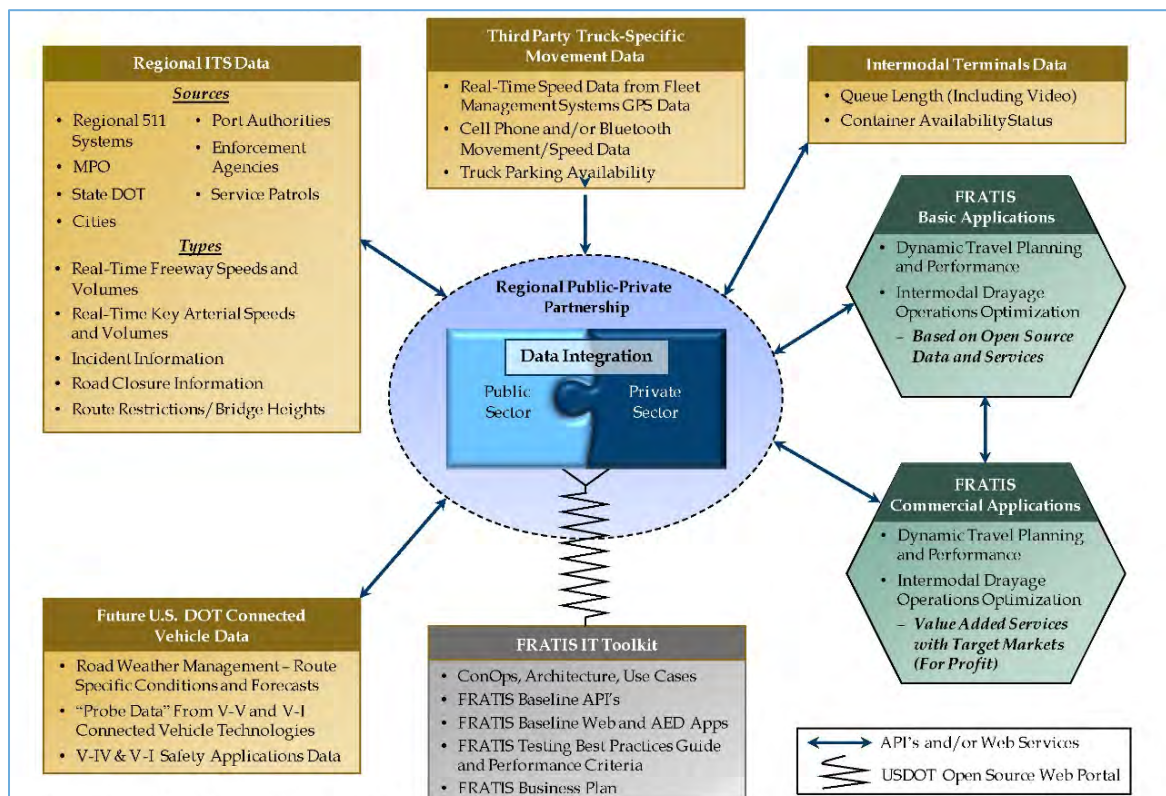

Figure 1 Proposed High-Level FRATIS System Concept (Jensen et al., 2012)

Two FRATIS application “bundles” contain Freight-Specific Dynamic Travel Planning and Performance and Intermodal Drayage Operations Optimization. The Freight-Specific Dynamic Travel Planning and Performance application bundle includes all of the traveler information, dynamic routing, and performance monitoring elements identified in the development of user needs for this project. The application will leverage existing data in the public domain, as well as emerging private sector applications, to provide benefits to both sectors. Relevant data includes wait times at intermodal facilities (e.g. ports), incident alerts, road closures, work zones, routing restrictions (hazmat, oversize/overweight). The Intermodal Drayage Operations Optimization application bundle will combine container load matching and freight information exchange systems to fully optimize drayage operations, thereby, minimizing bobtails/dry runs and wasted miles and spreading out truck arrivals at intermodal terminals throughout the day. Individual trucks are assigned time windows for pick-up or drop-off. These improvements would lead to corresponding benefits in terms of air quality and traffic congestion. (Jensen et al., 2012)

For instance, Figure 2 shows a full process view of the steps involved in the used of the LA-Gateway FRATIS system by PLG dispatching staff, and including information exchange with YTI terminal.

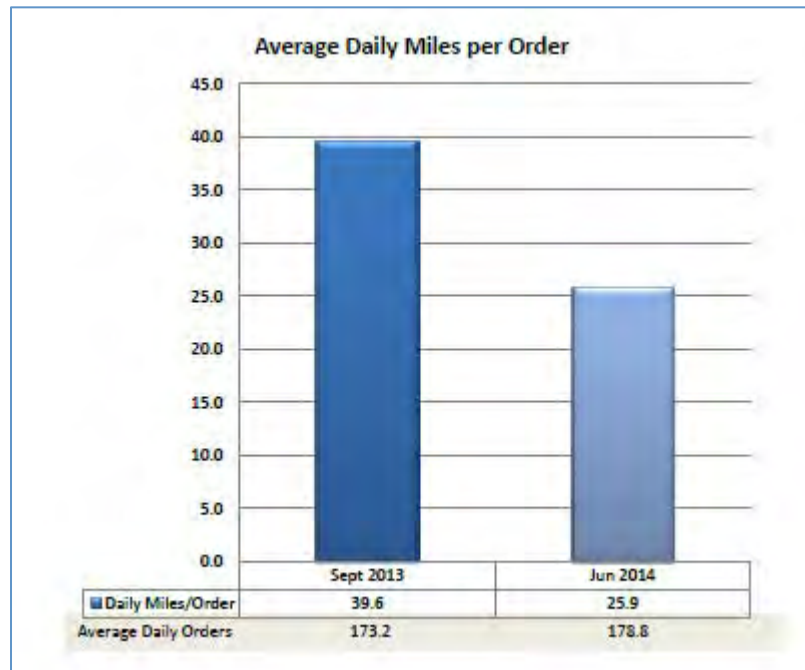

**Figure 2 Overview of FRATIS system 10-step process for uses in the LA-Gateway FRATIS Demonstration (Jensen, Fayez and DeSantis, 2015)**

## Expected Benefits

Based on the successful conduct of a previous analogous test of FRATIS-like technologies in Memphis, Tennessee, in 2009, under the U.S. DOT's Cross-Town Improvement Program (C-TIP), Jensen, Fayez and DeSantis (2015) identify and quantify a number of benefits. The program reduced the number of bobtail trips (i.e., empty-return loads) by 10 percent, terminal queue times by 20 percent, travel times by 15 percent, fuel consumption by 5 percent and level of criteria pollutants and GHG by 5 percent. Given that the C-TIP test was of relatively small scale, the results are promising for substantial benefits on larger scale implementation.

CDM Smith along with Booz Allen and North River Consulting (Troup, 2014) provided some preliminary assessment results for LA-Gateway demonstration case. They compared test data with baseline data and calculated several indicators related to efficiency of system. Figure 3 shows the average daily miles per order before and after the installation of the FRATIS system (Jan to Feb 2014). The daily mileage per order has dropped significantly within less than one year.



**Figure 3 Average miles per order before and after the installation of the FRATIS system**

Figure 4 shows the average daily miles, trip time and stop time per order before and after the installation of the FRATIS system. All the three indicators have dropped significantly within less than one year.

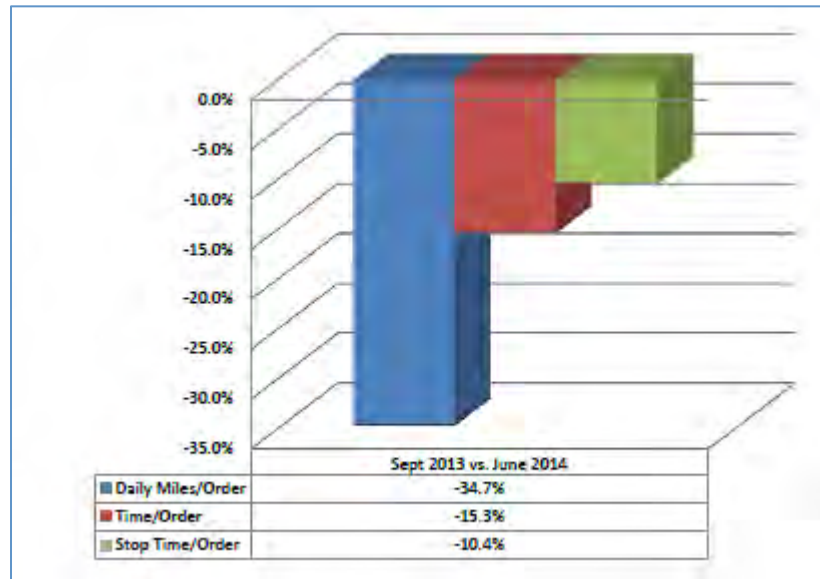

**Figure 4 Daily mileage, time and stop time per order before and after the installation of the FRATIS system**

### Expected Costs

Operations costs will be borne by three primary entities including trucking companies, transportation agencies and fleet information private sector vendors (Jensen et al., 2012).

Trucking company dispatchers/operations managers will need to install FRATIS at both their offices and on the Application Enabled Devices (e.g., smartphones) of their drivers. Internal training will also be required for both the web and mobile FRATIS platforms. The companies may also elect to purchase value-added commercial versions of FRATIS applications that may be available from fleet management/routing/traveler information private sector vendors.

Transportation agencies will need to include a component of TMC operations dedicated to the FRATIS system data exchange. These agencies will also need to provide for implementation and continued operations and support of any freight-specific ITS sensors (e.g., key freight arterials volume/speed sensors). Agencies responsible for integrated corridor management on freight-intensive routes will need to work together to make sure all relevant data are available and feeding into FRATIS (this could include local traffic signal systems, state DOT freeway management systems, route restrictions, commuter rail train management systems, and other data streams for a particular corridor). Also, these agencies will need to operate the continuous collection and assessment of freight performance information derived from FRATIS.

Fleet management/routing/traveler information private sector vendors will need to assign appropriate internal operations resources to manage the data integration associated with open-source data exchange with the regional public sector transportation agencies. It is assumed that companies will recoup the cost of participation in FRATIS through the development and marketing of commercial value-added FRATIS applications which would likely

require paid subscriptions or other pricing/cost recovery methods. For example, a fleet management vendor could conceivably develop a specialized version of FRATIS that would be designed to serve drayage reefer operations for seafood companies.

### **Role of the Public Sector**

Taking the LA-Gateway demonstration as an example, Public-Sector Test Participants/Stakeholders mainly include LA Metro, Gateway Cities Council of Governments and Port of Los Angeles and Port of Long Beach (Jensen, Fayez and DeSantis, 2015). Among them, LA Metro is the public-sector test partner that is interested in examining FRATIS data outputs to potentially help plan for infrastructure improvements in the region to facilitate movement. LA Metro is also the major transportation agency that funds a significant portion of the County's network infrastructure. Gateway Cities Council of Governments is a key public-sector sub-MPO (covering the port region and the I-710 freeway, and encompassing two million citizens living in Southeast Los Angeles) stakeholder which developed the Gateway Cities Technology Plan for Goods Movement. This plan lays the institutional groundwork for the LA-Gateway FRATIS test. As the largest port complex in North America, Port of Los Angeles and Port of Long Beach are both supporters and stakeholder for this project. Port personnel have been working closely with U.S. DOT and YTI concerning potential deployments of FRATIS and related ITS in the region.

A key institutional enabling element to deploy FRATIS in a given region will be the creation or use of a Public-Private Partnership (PPP). For the FRATIS concept to succeed, public and private sector freight movement and other data will need to be integrated and managed so as to support the specific data needs of the FRATIS applications. This will require organized cooperation between public sector organizations (e.g., MPOs, DOTs, cities) and private sector companies. The FRATIS PPP will be responsible for data and system integration (i.e., "standing up" FRATIS in the region) and project development and ongoing operations (Jensen, Fayez and DeSantis, 2015).

It is anticipated that the FRATIS regional public-private partnership will administer the operations and maintenance of FRATIS, with the private partners primarily acting as data providers with public sector agencies providing labor and physical plant (e.g., server space) to stand up the system. This approach is preferred because it is unlikely private partners will do this on their own, and may need guidance/assistance from transportation agencies. Operations and maintenance may be completed using in-house staff and IT resources, or it may be performed by a government contractor (Jensen, Fayez and DeSantis, 2015).

### **Implementation Challenges**

There are several challenges to be overcome if FRATIS or a similar system is widely deployed within the state. The first is cost. To date, the FRATIS demos have received significant funding from USDOT. It is unlikely that federal support would be provided for an ongoing program in the current federal fiscal environment. Thus state and local agencies would need to identify funding both for capital investment and the ongoing operation and maintenance of the system.

The FRATIS demonstration evaluations have generated some suggestions for addressing operational challenges (Jensen, Fayez and DeSantis, 2015; Williamson et al., 2015; Newton et al., 2015):

- Developing an early and consistent involvement of public and private freight stakeholders;
- Leveraging innovation to improve the relationship between the port trucking community and the port terminals community;
- Identifying stakeholders that see the value in innovation as a means to improve their operations is critical to maximizing the benefits of a deployment;
- Selecting appropriate partners who have the ability and willingness to participate in the optimization system;
- Setting up a framework that have the support and commitment of senior management at the onset to communicate to the organization that participation is supported and expected.
- Dealing with the fact that Small scale demonstrations, by definition, may not demonstrate enough benefit to maintain necessary stakeholder involvement.

Several operational constraints for FRATIS deployment and operation need to be overcome according to Jensen et al. (2012). First, FRATIS should be deployed on a regional basis and require a metropolitan regional-level focus. Based on the findings from the User Needs assessment, the primary target market for FRATIS applications is local and regional intermodal trucking drayage carriers, with a secondary market being small- and medium-sized local and regional truck carriers (non-intermodal). In addition, the public sector information sources that will be utilized and integrated into FRATIS by the private sector vary greatly between major metropolitan regions in the U.S., and even within some states.

Second, FRATIS relies heavily on public-private partnerships. Public and private sector freight movement and other data will need to be integrated and managed so as to support the specific data needs of the FRATIS applications. This will require organized cooperation between public sector organizations (e.g., MPOs, DOTs, cities) and private sector companies, which are expected to deploy applications based on FRATIS. Third, the geographic coverage of FRATIS will be limited. In a given metropolitan region, it would be unreasonable to expect that every single possible route that could be used by a truck would have real-time information available to it; FRATIS will need to focus primarily on critical and major freight freeways, arterials and intermodal connectors. The operational capabilities of FRATIS in a given region will thus be constrained by the data sharing/integration framework that is utilized by the public and private sector. Legal Agreements, Memorandums of Understanding, and Private Sector Return of Investment (ROI) will all need to be addressed by regional data sharing/integration frameworks.

### **Measuring Success**

Each of the demonstration cases has developed a set of system testing framework to evaluate the effectiveness of the FRATIS system. For instance, the Figure 5 below provides a summary of the focus of which elements of FRATIS were tested, and relates these to the expected benefits

hypotheses that were developed early on based on user needs and expected benefits to the users (Jensen, Fayez and DeSantis, 2015).

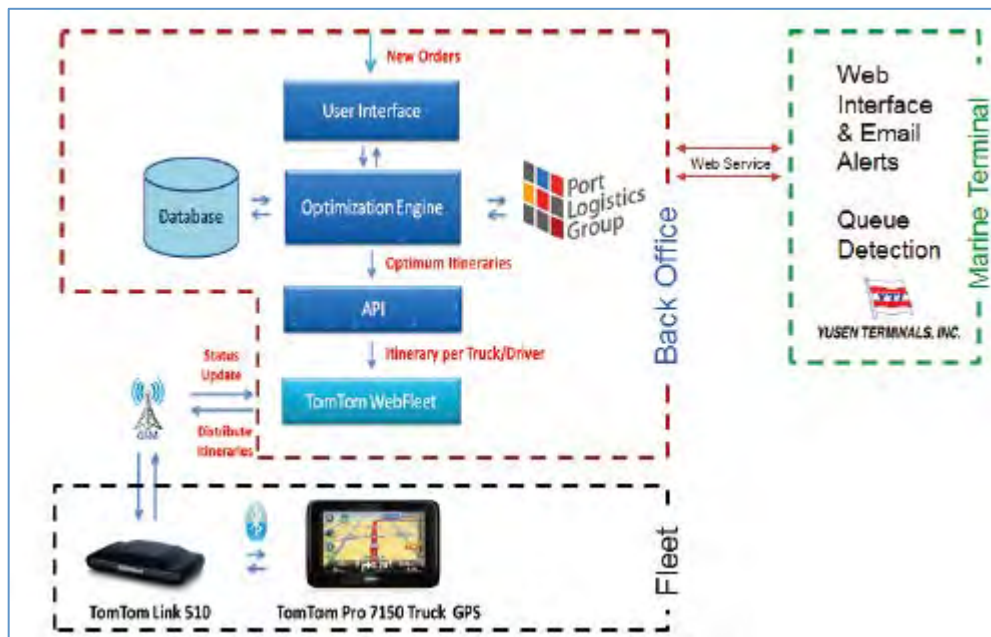

**Figure 5 FRATIS system testing overview**

Table 1 shows the data needed for the testing and the test hypotheses used to evaluate the success of each component of the system (Jensen, Fayez and DeSantis, 2015). However, none of the three demonstration cases has provided real data for testing the effectiveness of the FRATIS system yet.



**Table 1: Data Needed for Evaluation**

System	Data needed	Elements	Test Hypotheses
Drayage optimization	<ul style="list-style-type: none"> <li>Daily orders from the drayage company.</li> <li>Optimization algorithm using the order data to optimize drayage moves</li> </ul>	<ul style="list-style-type: none"> <li>Order Entry—simple Excel spreadsheet to be populated manually.</li> <li>Optimization algorithm—Runs through the spreadsheet and provides a daily plan that will maximize productive moves and minimize nonproductive ones, accounting for historical traffic and terminal waiting times.</li> <li>Dispatch—PLG dispatchers can accept or reject algorithm-recommended moves based on business needs; they will communicate instructions as they do now or using TomTom devices.</li> </ul>	<ul style="list-style-type: none"> <li>The drayage optimization algorithm will provide an optimized plan for the day’s moves that will accomplish all required moves in the most efficient manner possible, accounting for the business constraints—this will result in reduced miles traveled, reduced trips, fewer bobtails, less bobtail miles, and corresponding reductions in emissions.</li> </ul>
Freight traveler information dissemination	<ul style="list-style-type: none"> <li>Traveler information Web site ‘one-stop shop’ with real-time route and marine terminal operators (MTO) information</li> <li>Dynamic route guidance based on real-time traffic and route data</li> </ul>	<ul style="list-style-type: none"> <li>Traveler information Web site ‘one-stop shop’ with real-time route and marine terminal operators (MTO) information for dispatchers and drivers.</li> <li>Dynamic route guidance for drivers—routing, including real-time truck-friendly dynamic routing.</li> <li>Public-sector freight performance monitoring—Web site with freight movement data compiled throughout the test.</li> </ul>	<ul style="list-style-type: none"> <li>Truck drivers will use dynamic route guidance feature to route around congestion, saving travel time and potentially reducing emissions.</li> <li>Public agencies will use data generated by FRATIS to assist in freight planning and investment decision making.</li> </ul>
Drayage-to-marine terminal operators communication	<ul style="list-style-type: none"> <li>Predictive queue-time information by drayage operators</li> <li>Real time route recommendation.</li> </ul>	<ul style="list-style-type: none"> <li>Dray advance estimated time of arrival notification messages to the marine terminal operators.</li> <li>Dray 10-minute en route real-time advance notification message to marine terminal operators.</li> <li>Marine terminal operators queue time information and alerts to dray dispatcher.</li> <li>Marine terminal operators general messaging and alerts communication to drayage companies while trucks are in terminal.<sup>1</sup></li> <li>A basic web interface for drayage dispatcher, and either a web interface or an email-driven solution for the marine terminal operator.</li> </ul>	<ul style="list-style-type: none"> <li>This system will develop an effective communications linkage between the drayage dispatchers and the Yusen terminal operators at the port.</li> <li>PLG dispatchers will use the predictive queue-time information to avoid sending trucks to YTI during the most congested times of the day, resulting in shorter overall turn times for participating trucks.</li> <li>MTO operations staff will use dray approach advance notification features to better plan labor and equipment orders, and container stacking in the yard (proof of concept only).</li> </ul>

(Source: Cambridge Systematics, Inc.)

<sup>1</sup> Due to liability concerns, both YTI and PLG determined at the start of testing that they did not want to have direct communications between MTO staff and truck drivers.

## SYSTEM-WIDE APPOINTMENTS AT MAJOR SEAPORTS

### Statement of the Problem

There are many delays in the drayage process: congestion on roadways, queuing at terminal gates, queuing or waiting to drop off or pick up, queuing or waiting at the destination. Appointment systems are intended to reduce truck queuing, increase velocity of container movement, and reduce container dwell time. Appointment systems target productivity and efficiency at port terminals via the implementation of information and communication technologies (Giuliano, et al. 2008; Morais & Lord, 2006).

### Description of the Strategy

An appointment system provides time windows for drayage transactions (pick up, drop off). The basic system would have an information platform that informs shippers of container, chassis and space availability. Shippers select a time window for the transaction, and a truck is dispatched to arrive during the time window.

Appointment systems have potential benefits for both terminal operators and truckers and shippers. Appointments allow terminal operators to optimize utilization of resources. If terminal operators know in advance which containers are being picked up or dropped off, they can better manage truck flows and container moves within the terminals. This information is particularly useful during the evening and on weekends when labor costs are higher. The ability to predict gate moves allows for the more efficient ordering and use of longshore labor. Appointments would also translate to shorter turn times for truckers, as less time would be spent waiting for a container to be available. Appointments could also be used to meter truck arrivals to prevent congestion on the dock.

### *The Ideal Appointment System*

In order to generate maximum benefits, an appointment system would have the following attributes:

- A universal system consistently applied across all terminals in the port complex
- A single information platform accessible to all users
- Priority gates at each terminal so that truck incurs no delay at gate
- Coordination of gate entries and dock transaction (e.g. container fully ready for pickup at the time of truck gate entry)
- The capability to generate appointment windows and fill them at least one day in advance
- High rate of compliance

There are many actors involved in an appointment system, including ports, terminal operators, shippers, drayage truckers, and BCOs

There are several examples of appointment systems planned or in operation. We describe examples from North America and Australia.

### ***Appointment Systems in Response to AB 2650, California***

In 2002 AB 2650 sought to reduce vehicle emissions and highway congestion by reducing truck queuing at marine terminal gates and distributing truck traffic over a greater period of time throughout the day. The legislation permitted terminals to adopt either gate appointments or off-peak operating hours as a means of avoiding fines for truck queues. Given the costs and difficulties of implementing off-peak operating hours, most terminals chose to implement appointment systems. An evaluation found that 1) use of the appointment system depended upon operating policies of individual terminals; 2) perceptions of the appointment system's effectiveness differed across user groups; 3) there was no evidence that the appointment system affected queuing at marine terminal gates; 4) while a majority of the terminals did implement an appointment system in response to the legislation, most did so in order to avoid paying the high labor costs associated with extending operations to off-peak hours, and hence had little incentive to develop an effective system (Giuliano et al, 2008).

### ***APL Terminal, Los Angeles***

APL terminal implemented an appointment system and expanded gate hours in response to a container volume surge that made it necessary to shift from an all "on wheels" pickup system to a partial stack system (JOC, 7/31/14). The terminal did not have sufficient cargo handling equipment or longshore labor to manage stack moves. The system required truckers to make a container appointment 24 hours in advance with a four-hour window to account for possible delay. Containers were assured to be on chassis when truckers arrived at the terminal. Having the container ready for pickup guaranteed expedited treatment, and hence incentivized compliance by drayage truckers. As a result, the average transaction time decreased from 100 to 60 minutes.

### ***Port Botany, Sydney, Australia***

Port Botany implemented a "vehicle booking system" (VBS) in 1999 in order to maintain a "high level of terminal efficiency and maintain acceptable turn times for trucks" (Davies, 2009). The VBS has been a success. The percentage of trucks processed within a 60 minute turn time (measured from in-gate to "truck complete" – truck loaded or unloaded) increased from 73% in 2005 to 85% in 2006. (Davies, 2009, p. 13) Davies (2009) reports that the average in gate to out gate time was 51 minutes from January 2001 to June 2007, much less than was experienced in the early 1990's before introduction of the VBS.

### ***Napoleon Avenue Container Terminal, New Orleans***

Napoleon Avenue container terminal at the Port of New Orleans, LA, adopted the appointment system in 2003 in order to better use terminal space and reduce gate congestion. Similar to APL terminal's case, it is designed to intervene and solve problems before trucks arrive at the terminal. The terminal is relatively small; It handles 1,100 gate moves per day.

### ***Port Metro Vancouver***

Port Metro Vancouver: The Vancouver port has implemented a number of strategies to reduce truck queuing and improve port operations efficiency. An appointment system began in 2001 and has been continuously refined since. The appointment system is part of a suite of strategies, including a rigorous truck licensing policy, fines on terminal operators if turn times

exceed a specified maximum cap, and a PierPass like off-peak congestion management fee (Heaver, 2009).

### *Ports of Los Angeles and Long Beach*

The operator of PierPass has initiated an effort to organize a ports-wide appointment system. As of August 2015, 10 of the 13 container terminals “adopted a trucker appointment system action plan with the goal of establishing a system of appointments throughout the harbor beginning in 2016.” (JOC, 8/27/15). As currently envisioned, each terminal would have its own system, but will comply with 3 rules: (1) appointments will be mandatory; (2) they will apply to imports only; (3) the appointment system will be operated via links from the PierPass website. Appointments are seen as part of a comprehensive program of efficiency improvements at the ports.

Although many appointment systems are either operating or being planned, none of them have the full list of attributes required for a maximally effective, system wide appointment system as described in the previous section. The Port Authority of New York and New Jersey (PANYNJ) is scheduled to launch a common portal appointment system in 2016 that may provide guidance on development of the California systems.

### **Expected Benefits**

There are many potential benefits from a ports wide appointment system. The literature identifies increased throughput, reduced wait and turn times, increased gate efficiency, increased equipment utilization, and the capacity to plan truck moves across the day (Moras and Lord, 2006; Huynh and Walton, 2008; Namboothiri and Elera, 2008; Huynh, 2009)

Most studies of appointment systems are based on various types of simulation, and these studies consistently show productivity benefits. The only comprehensive empirical study is Giuliano et al. (2008). The Giuliano et al study is not likely to be transferable, due to the conditions under which appointment systems were implemented.

### *Simulation Studies*

With a simulated model based on queuing theory, Zhao and Goodchild (2013) tested the effectiveness of a truck appointment system and truck appointment information on container terminal yard efficiency. The model quantified the interaction between arriving trucks and a yard crane when trucks retrieve containers. The model tested the appointment system configuration – duration of appointment time window, container dwell time, and appointment lead time – in terms of the import container retrieval operation and container re-handling. The authors report an increase in terminal yard operation efficiency. The appointment system improved yard crane productivity and truck transaction time. The terminal could enhance system performance in these cases: (1) a longer appointment lead time (two days vs. one day) could ensure better scheduling of yard crane, (2) in case of a short container dwell time, reduced duration of appointment window could enhance yard efficiency, but the effect diminishes as the dwell time increases, and (3) the yard crane performance could be resilient against the use of inaccurate information or missing appointments if the early/late arrival is within the 4 hour window. It is because the yard crane operation algorithm makes a container location decision in a way that minimizes re-handling of containers.

Huynh and Walton (2008) combine mathematical formulation and computational simulation to seek a solution that optimizes the number of trucks entering the container yard with respect to truck turn time and yard crane operation efficiency. The optimum solution must benefit both the terminal and the truckers and be robust against late or missing appointments. The authors conducted experiments using data collected in May, 2003 at the Barbour Cut Container terminal, Port of Houston. The simulation and experiments documented that the appointment system could allow terminals to plan truck moves per day based on capacity and resources. Smoothing – reassigning of trucks that exceed the terminal cap in the next hour period – is beneficial in that it could enhance yard crane utilization and decrease truck turn time.

Using a drayage operations planning approach, Namboothiri and Erera (2008) develop an integer programming heuristic to evaluate the container pickup/delivery sequences that minimize transport costs in order to test the potential productivity gain of the appointment system. A minor change in gate appointment configurations can significantly affect the productivity of drayage firms. Terminal operators should provide enough appointment capacity for effective drayage. According to the authors, a 30% increase in appointment capacity brings about 10-24% improvement in vehicle productivity. An improper selection of appointments could result in up to 4% decrease in the number of serviced customers. A 50% reduction in the appointment window duration necessitates a 4% increase in total terminal capacity.

Using data from field observations, Guan and Liu (2008) develop and test a multi-server queuing model to evaluate gate congestion and its impact on the truck waiting cost. Data were drawn from a terminal at Port of NY-NJ. The optimization model aims to minimize terminal gate congestion and truck waiting time/costs, and does not consider transaction time within the terminal. If optimized, a small increase in gate capacity could 'drastically' reduce truck waiting time. An appointment system could be 'the most viable way' to increase system productivity and decrease terminal gate congestion, because it does not require a large expenditure or adjustment of manpower and land expansion. Coordination among shipping lines, shippers, terminal operators, and trucking companies, and all stakeholders is necessary.

Huynh (2009) uses a simulation model to test scheduling rules that might affect truck turn times and ultimately system resource utilization. He also evaluates factors that might influence scheduling performance. The scheduling rules are adopted from the health care sector: individual appointment system (IAS) and block appointment system (BAS), and compared to a no scheduling baseline. Relative to no scheduling, IAS does not increase productivity of yard cranes, but reduces internal yard turn time by about 44%. BAS increases crane productivity, but imposes longer turn times on truckers. IAS is superior to BAS because IAS is robust in the case of walk-ins, late or missing appointments. IAS benefits both the terminal operator and truckers. With caution, the terminal operators must minimize the number of walk-ins, as IAS is sensitive to it. Or an increased spacing between the appointments is necessary.

### *Empirical Study*

Using data from 3 terminals, Giuliano et al. (2008) examined use of appointments, compared turn times with appointments, and used data from 2 terminals to estimate turn time savings at

different levels of appointment use. Use of appointments varied greatly across terminals and reflected practices of the individual terminals (see figure 6 below). On average, about 63% of appointments were kept by truckers, with the most frequent reason for missing appointments being delays at the marine terminal. There was no significant difference in turn times between those using appointments and those not using appointments. There was no data available to quantify impacts on terminal operations. Potential total turn time savings (including gate queue time) for imports only was estimated based on data from two terminals. Depending upon the amount of queue and transaction time savings associated with appointments, and on the extent to which appointments are used, savings range from 2% to over 10% of total turn time across all daily transactions (see figure 7).

The Giuliano et al. study is not likely to be transferable, due to the conditions under which appointment systems were implemented. Appointment systems were implemented in response to state legislation which required terminals to either extend gate hours or implement an appointment system in order to reduce emissions from drayage trucks waiting at gates or in terminal yards.

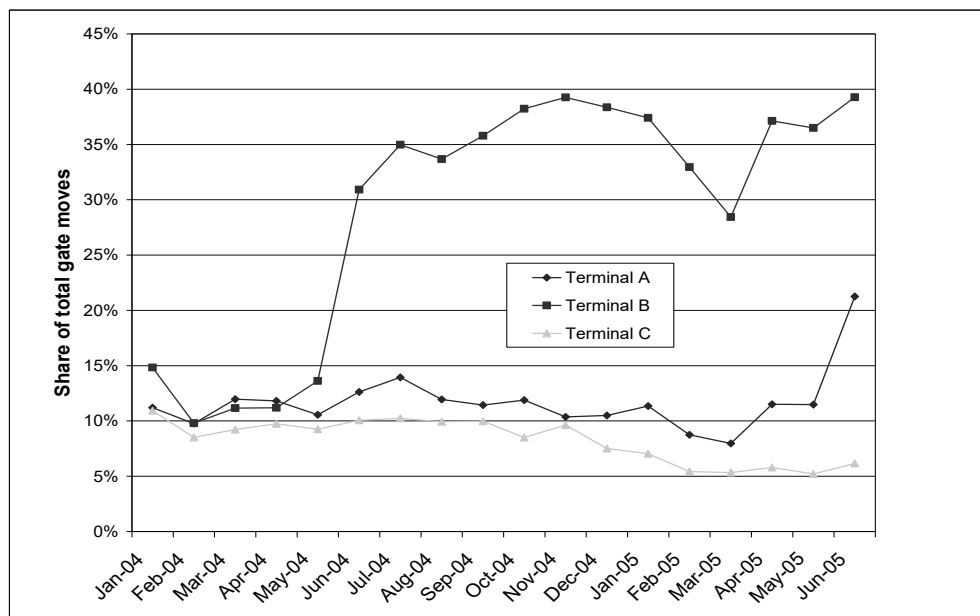
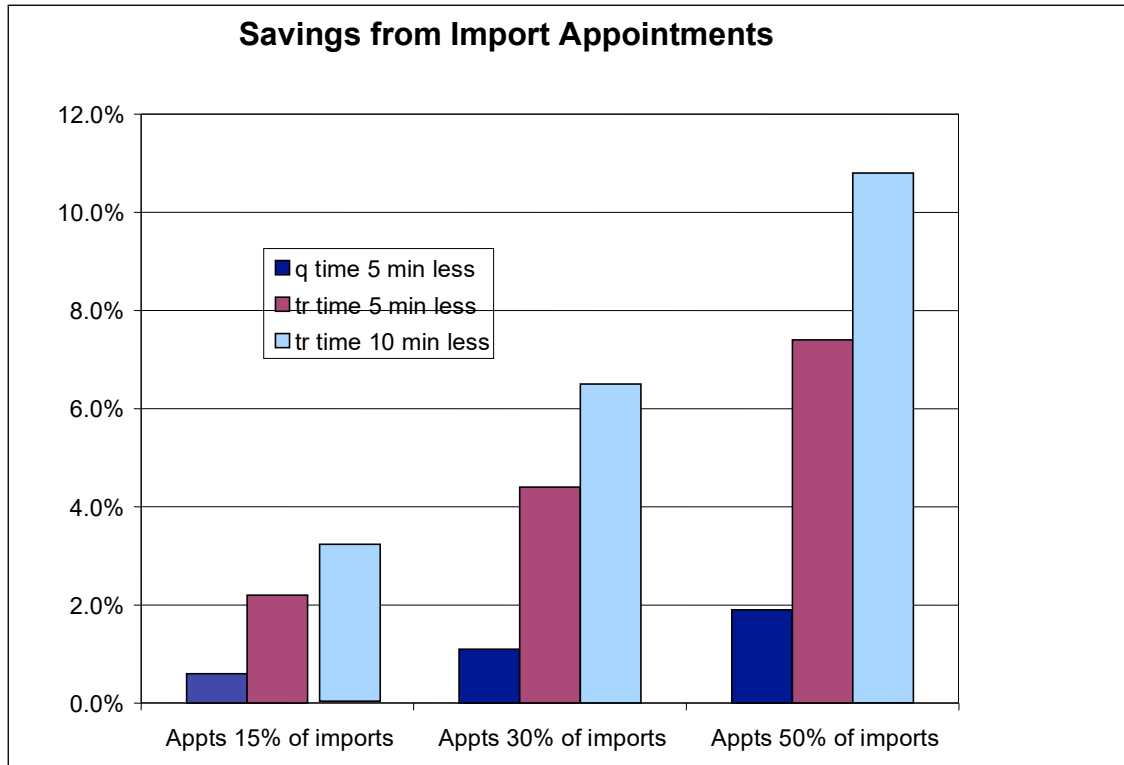

Figure 6 Appointments as share of gate moves (Giuliano et al, 2008)



**Figure 7 Estimated turn time savings under different assumptions (Giuliano et al, 2008)**

### Expected Costs

There is no information on the financial costs of developing and operating an appointment system. In the case of a ports wide system, there would have to be an information and communications system to collect data from terminals, generate appointment windows, and allocate windows. The system would need real-time capability to adjust to unanticipated delays (trucker stuck in traffic, trucker delayed at previous stop, container not located, etc.).

A system wide appointment system would involve substantial transactions costs to design a system that would be acceptable to all stakeholders.

A system wide appointment system would generate winners and losers. Some shippers/truckers would not get preferred time windows, and appointments that are optimal for the terminals are not necessarily optimal for shippers/truckers. Although some research has been done on joint optimization, whether such tools are sufficiently developed for large scale implementation is uncertain.

### Role of the Public Sector

Appointment systems at the individual terminal level have been implemented in ports around the world. We have fewer examples of port wide systems, with Vancouver one notable case in North America. In Vancouver the government has played a strong role via regulation of the drayage industry (e.g. the truck licensing policy) and of the terminals (e.g. the fine system for

long gate wait times or turn times). In California, the port authorities, as managers of the port, would be a logical entity to manage a port wide system. Port authorities understand port operations and have interactions with the key stakeholders that would be involved in developing and operating an effective system. Another possibility is a multi-terminal group such as PierPass, with the port authorities setting policy and framework, and the terminal group implementing the program. The argument for a terminal group is that direct market participants who receive the benefits and costs have more incentive to develop an effective program.

The public sector may play a key role in incentivizing participation, serving as a “neutral forum” for developing an appropriate and effective appointment system, and possibly funding the upfront information infrastructure that would be required.

### **Implementation Challenges**

There are many implementation challenges to a port wide appointment system. First, there is a “supply side” and “demand side” of appointments. From the MTO perspective, the objective is to use equipment, labor, and terminal space as efficiently as possible. Ideally the MTO would issue a series of “calls” (time windows for specific pickups) that would maximize the total number of daily pickups. From the shipper/trucker perspective, the objective is to use the fleet as efficiently as possible (typically using optimal route sequencing). It is not necessarily the case that both objectives lead to the same outcome. That is, the appointment problem is a multi-objective optimization problem subject to constraints. Under such conditions, although the “system” outcome is the best possible, it will not be the best possible for at least some TOs or shippers/truckers (from their individual perspectives). Some form of compensation would likely need to be developed in order to achieve full participation in the system.

Second, benefits of the appointment system must be evident to all participants. MTOs must be convinced that appointments will lead to efficiency gains, or they have no incentive to implement or operate an effective system. Shippers/truckers must be convinced that appointments will lead to shorter and more reliable turn times, or they have no incentive to use or keep appointments.

Third, a port wide system requires some common infrastructure and operational practices. A port wide appointment system would require a common information platform. Currently, there are several different information exchange platforms, and they are not interoperable. Also, an effective appointment system requires coordination of gates and yard, which may require priority gates, new logistics practices, and other changes in terminal operations. MTOs vary in the type of product, a number of ships served, customer requirements, dock space, etc. It, therefore, would be difficult to implement a uniform system across all MTOs. At the same time, however, shippers/truckers operate across multiple terminals. Thus, the basic structure of the appointment system would have to be common, and the extent of variation in appointment practices (e.g. policies for selecting appointments, variability of turn times, etc.) would need to be limited. These issues are evident in the current PierPass effort.



Fourth, the extensive road congestion that prevails in both Los Angeles and the San Francisco Bay Area generates significant unreliability in truck travel times. While shorter time windows increase the effectiveness of appointment systems, the uncertainty generated by road congestion will force longer time windows, especially during daytime hours.

Morais and Lord (2006) conducted terminal operator interviews in 2005. Participating stakeholders included Port Authority of the Port of Montreal, Cast Racine Terminals at Port of Montreal, Port of Long Beach, Port Authority of New York-New Jersey, Port of Oakland and TransBay Container Terminal, Vancouver Port Authority, and Port of Seattle. The authors made the following observations.

First, the integration of the appointment system into the terminal operating system – that manages information of all container location, schedule of terminal operation, and the business rules – is critical. Second, it is essential that the system provides clear incentives and benefits for terminal operators and truck drivers, such as productivity enhancement via faster turnaround time. Terminal operators regard it important that they be capable of planning container moves on a daily basis according to their capacity. Third, extended gate hours (e.g. PierPass) and technologies (e.g. OCR, RFID, and CCTV camera) operated along with the appointment system significantly improved success rates. Fourth, successful implementation is critical in order to overcome human reluctance to new business practices. Lastly, a system based on the container is preferable to one based on reserving time, due to duplicate appointments on a container and/or greater cancellations. The former system allows better flexibility for truck drivers and shorter lead time between the moment truckers make appointment and the actual pick up. It eliminates the chance to overbook a container pickup.

The authors suggest several requisites for a working appointment system: it handles and reassigns cancellations; it allows appointments arranged during the day; it allows a short arrangement lead time prior to picking up; it prevents overbooking for the same container; it levies a penalty for a missed reservation (no-show); it allows tolerance for delayed show-up; it makes appointment based on containers, rather than on trucks; and it allows telephone reservations.

There are many aspects of a port wide system that would have to be worked out. Issues include 1) scope of the appointment system (e.g. pickups only, all container moves, or all truck moves, and over what part of the day); 2) how to integrate with other efficiency strategies such as “peel off pile” operations; 3) how and to what extent should each MTO determine system rules; 4) how to discourage missed appointments.

### **Measuring Success**

Conceptually, measuring success is straightforward, as a before/after analysis could be done, provided the necessary data are available. A baseline would be needed in order to measure success. This would require a substantial data gathering exercise before implementation. The data to measure gate-to-gate turn time is available from MTO records. Queuing outside the gates is more difficult; it requires some form of truck tracking system, or some form of field sampling.

It will be important to develop metrics for both MTOs and truckers so that stakeholders on “both sides of the gates” have information on the progress and benefits of the appointment system.

## **LOAD TRACKING SYSTEM**

The concept of a system-wide load tracking system is to make the status (location, contents, origin, destination) of every shipment transparent, meaning readily available in near real-time to all relevant supply chain participants, including ocean carriers, ports, MTOs, rail and trucking, BCOs, etc. We present this as a “stretch goal” that would take several years to accomplish. If accomplished, such a system could generate significant efficiency benefits, and reduce fuel consumption and GHG emissions.

### **Statement of the Problem**

It is difficult to improve freight efficiency without knowing where freight is in the supply chain. Investments to improve supply chain efficiency, such as improved berths, roads and railroads are intended to make the supply chain more efficient and more reliable, yet without understanding the experience of individual loads, it is difficult to determine the extent to which such investments are actually improving the situation. A small minority of errant loads tend to cause a disproportionate degree of delay within the supply chain. When loads are missing, when they are misidentified, or when they arrive earlier or later than expected, delays can accrue not only for the problematic load but also for the other loads within the system.

While brokers and 3PLs arrange each leg of cargo’s journey, they have traditionally had little control or insight into the exact routes chosen by transportation providers in moving from origin to destination. Through tracking technologies, most of which are currently cell phone based, brokers for the first time have the ability to know with precision how a load moves from origin to destination. This may allow 3PL’s to more reliably optimize routing as they will have a better understanding of weaknesses within the supply chain by studying each load’s “bread crumb path”. Tracking can provide documentary evidence of the net effect of congestion on individual loads which can be useful evidence for policymakers who are considering options for improvement.

At present, a system to track cargo from end to end exists, however it exists in a piecemeal fashion and in most cases has yet to be stitched together. There is evidence that greater supply chain coordination is now occurring at all levels in order to expedite clearance for terminals that are capacity constrained. For example, steamship lines now coordinate vessel stowage of individual containers at the port of origin and port of departure to expedite unloading and processing. (Mongelluzzo, 2016) On the next step of the supply chain, vessel unloading of individual boxes (or, alternatively, blocks of containers) can be coordinated to expedite on-dock rail deliveries. This technique has been used in Seattle-Tacoma. (Mongelluzzo, 2015)

## **Description of the Strategy**

To date, there has been no coordinated national effort to track cargo in a systematic way. A number of proprietary programs have been developed by the private sector that utilize driver's cell phones to track cargo. Some use apps and thus can only be used with smartphones whereas others can be used with any mobile phone. As these technologies proliferate, a major concern is avoiding redundancy. At present, as cargo travels through the supply chain, it is tracked in different ways by multiple parties, to varying degrees of precision. One question is whether the proposal should advocate a single method of tracking that would stay with the cargo through multiple steps.

The ideal concept is an end-to-end system with information available to the relevant supply chain participants: ocean carriers, ports, MTOs, BCOs, rail and trucking, etc. With technology allowing for ever smaller and cheaper sensors, it is technically feasible to add a "sensor ID" to every shipment. The sensor would have communications capability with information on contents, origin, destination, and other essential data. It would have GPS-type capability, so that its location could be tracked in real- or near real-time. The conceptual model is based on Fedex or UPS, expanded to include multiple users.

The load tracking system would require a common information platform that includes a central server that stores the data, database tools to manage and update data; a streaming capability to receive and process data in real-time, and APIs (application program interface) for interacting with the database to allow for web service querying of the data. It would require a manager and set of protocols regarding what data are stored and for how long, who gets access to the system, protection of proprietary data, storage of the data, data security, who pays to develop, maintain and operate the system, and other operating considerations. It would need a host acceptable to and trusted by all parties.

Another possible approach is to connect and integrate the various specialized information systems that are being developed and sold by private vendors. There would be many challenges to integration, including incompatible data structures and software, differences in data, lack of control over software and hardware changes, difference in access policies, etc.

## **Expected Benefits**

Cargo transparency by itself does not provide direct benefits, but there are many instances in which time savings could be realized if this information is intelligently acted upon. For example, a load tracking system tied to individual containers could allow dispatchers to know when a container has been moved from the stack and will likely be ready for pickup. This would allow a driver to be dispatched as soon as the cargo is available, thereby lowering dwell time on the yard. It would also facilitate an effective appointment system.

If patterns of shipments are evaluated, it could lead to more effective load matching both for LTL trucking options as well as for train assembly. Load tracking would increase the predictability of shipments which would potentially benefit the slower and more carbon efficient modes of freight transportation such as rail.

As most current tracking technologies are tied to individual drivers, technologies used for transparent load tracking can be used to better utilize existing trucking capacity and better match loads with transportation providers. Technologies such as Cargo Chief can notify dispatchers if drivers divert from their routes (Cassidy, 2015). This is not a new concept, but has been discussed since the introduction of Electronic Data Interchange (EDI) in the 1980s (Siedeman, 1989). The following is a description of a system currently under evaluation at the Ports of Seattle and Tacoma.

...“there’s the rugged, portable *tracking* device, battery-operated and weighing about five or six pounds that was designed by Safefreight originally for truck trailers and vehicle fleets. The SecurityGuard SG212 uses *GPS*, wireless and Internet technologies to provide data on location, speed, direction, starts, stops and other measures. The port can trace the exact location of a container, virtually in real-time, through a Web map portal that’s similar in appearance to Google Earth. It measures 5 inches by 3 inches by 3 inches deep and transmits data wirelessly through cellular communications to a Safefreight server” (Dibenedetto, 2009).

The main immediate benefits from load tracking include the elimination of “check calls” that are basically aimed at gauging an ETA from the driver. There are few estimates that attempt to quantify the net gains from automated load tracking, however the following quote seems to suggest that savings could be significant:

“We expect to gain over 50% in efficiency in our Traffic Management and Dispatch operations. (from installation of Geotracking software)” - John Huggins, Chief Commercial Officer at FX Logistics. (Fleetowner, 2016)

Load tracking could also aid in inventory management. Increased predictability reduces uncertainty, which in turn reduces the need for extra stock. Problems further upstream in the supply chain, such as a customs delay, could be transmitted to downstream receivers in time to make adjustments and hence avoid shortages.

### **Expected Costs**

The costs of implementing cargo tracking depend in large part of the extent to which such a system is truly “universal”. For certain loads, the costs of cargo transparency have already proven to be justifiable given the precious status of the cargo, yet for low valued non-time sensitive shipments this calculation will produce a different result. As cargo tracking becomes more widely available, the cost of the service is expected to decrease, particularly for areas of the country that have reliable 3G coverage.

Given the fact that the tracking technologies work off software based on a smartphone or cell phone platform, their cost to enter the market can be quite low. In some cases, tracking solutions are even provided for free. For example, a firm called FourKites CarrierLink will

provide load tracking for up to 2500 loads per month for free. (Fleet Owner, 2015) It bears noting that a sensor-based tracking system would go beyond the truck or rail trip, provided information on where the load is at the terminal or at a distribution center.

In addition to start ups, the major institutional players are also developing their own proprietary tracking technologies. For example, in late 2014 JB Hunt launched JB Hunt 360. The smartphone based app allows real time load tracking for any JB Hunt customer. This adoption shows that real time tracking is no longer a niche application for specialty loads but is becoming a standard feature for all types of cargo. (JB Hunt, 2016) The JB Hunt 360 application works for multimodal shipments as the rail carrier transmits location data to JB hunt which displays this information on the same dashboard used to track truck shipments. In this sense, the JB Hunt 360 application comes closer to the concept of a universal system.

### **Role of the Public Sector**

In most cases, the data collected by load tracking software is private and proprietary. As noted earlier, there might be numerous benefits that would emerge from compiling this data into a single database to give a complete real time picture of the flows of freight shipments on the various networks (road, rail and river systems). If a system could be developed that would delay release to governmental agencies until the information is no longer considered sensitive, release only a sample (akin to the carload waybill sample) or release in real time with certain elements of the data (such as ownership) suppressed. Furthermore, as the collection of real time data on cargo status and location becomes more commonplace, the tendency of freight providers to view the location or status of their assets as proprietary may partially abate.

With the advent of companies such as Cargomatic, more 3PLs are viewing cargo visibility as an essential productivity tool (Cargomatic, 2016). Unlike most cargo visibility applications that target long haul trucking, Cargomatic has focused on the drayage industry and has coordinated its efforts with the Ports of Los Angeles and Long Beach to improve cargo visibility within the terminal. (Cargomatic, 2016) While the government has not yet mandated any type of in terminal tracking technology, this may change if the technology proves to show overall efficiency gains, particularly in terms of gate productivity.

### **Implementation Challenges**

A major implementation challenge is how to translate the long term management of the load tracking information system into economic benefits, which requires acting upon the information. Supply chain actors will need to be convinced that information sharing generates benefits to them, and incentives may be required to promote acting upon the information.

Any system of universal load tracking will necessarily develop as a phased implementation. As illustrated above, there are a number of technologies that are already being implemented at different levels of the supply chain. Given the proliferation of technologies, it may be too late in the game for a government imposed mandate that would specify a single technology and system of information gathering to be feasible. On the other hand, as noted above, there would be significant challenges in integrating disparate systems.

If the government hopes to use the wealth of data that is currently being gathered for broader freight planning purposes, it must develop incentives to induce the private sector to share the data. In certain areas, for example when load tracking correlates with a potential national security concern, there may be a stronger case for compelling shippers to turn over data on load tracking. The major incentive, however, is the benefit to the data owner in making his/her business more efficient.

Different governmental agencies have to determine what constitutes “Universal” for their purposes. The standard will likely differ depending on whether transportation logistics professionals or security parties are setting the criteria. If transportation planners are setting the terms, the definition would likely be looser, i.e. the point where marginal cost would exceed marginal benefit would occur sooner. Conversely, if the determination is made for security purposes, they will be more likely to insist on a 100% scanning criteria, however if they deviate from this standard they would be more likely to not require tracking for domestic shipments, cross border shipments from Canada and from any other foreign party that is considered secure.

One clear area where tracking may dovetail with security is the ongoing effort to scan and secure imports of containerized trade entering the US. The US Congress has repeatedly delayed implementation of 100% container scanning. In July of 2014, the Department of Homeland Security announced another two-year extension of the deadline for scanning all containers bound for the United States at the port of origin, as was originally mandated by 2007 modifications to the 2006 SAFE Port Act. The legislation has produced controversy since the time of its passage due to uncertainties regarding its technical feasibility and impact on international trade.

There must be provisions for sharing data between private and public sector and the risk of data security. For the purpose of security, it is important for the data to be made available in close to real time. However, if the data is for transportation planning purposes, it could be received much later and partially redacted.

At present the vast majority of investment is going into smart phone GPS apps. Yet, this strategy has many limitations. Currently approximately a third of drivers carry smart phones (Macropoint, 2016). In addition, most technologies are aimed at long haul carriers. When cargo is handed off to multiple drivers, a cell phone-based tracking system could be difficult to sustain - particularly in the drayage sector which (outside of the San Pedro ports) tends to operate using older trucks and more basic IT.

Another complication in load tracking is its role in multimodal shipments. For rail, the delays in shipment delivery time can occur for multiple reasons that are not encountered by trucks. In addition, rail yard dwell time is a major concern for truck competitive cargo. Even if the rail operator is able to provide information to the beneficial cargo owner (BCO) that the load is “in

yard”, there is still a question of whether or not that information is useful to the BCO in determining when a load will make it to its eventual destination.

Another issue comes from the question of “load integrity”, i.e. what is the smallest unit of cargo that can be tracked? While there has been some attempt to track containers separately from the vehicles that escort them, it is difficult to track cargo through the transloading process as the load is subdivided or moved from a container to a trailer.

### **Measuring Success**

As the benefits do not derive directly from load tracking but are based on what is done with this information, it is premature to determine specific metrics. In the beginning, provided a system could be implemented, anecdotal evidence on supply chain efficiency enhancements could be publicized. In addition, if the data was used to support infrastructure investments, this could be seen as another measure of success.

## **STATEWIDE SMART PARKING**

### **Statement of the Problem**

Truck parking has been a problem of particular seriousness in California. According to a 2011 survey by the American Transportation Research Institute (ATRI), hours of service was identified as the 2<sup>nd</sup> most pressing trucking issue. In 2012, California was ranked 1<sup>st</sup> in commercial vehicle parking shortage among all states in the U.S., as demand exceeds capacity at all public rest areas and 88% of private truck stops along 34 of California’s corridors with the highest volumes of truck travel (California Department of Transportation, 2012). FHWA data suggests that in 2015, California has only 55 truck parking spaces per daily 100,000 truck VMT, which is the 3<sup>rd</sup> worst shortage in the nation only behind Hawaii and Rhode Island; the problem is most significant on the I-5 (Sells, 2015).

The results of a survey conducted on the I-5 suggest that most truck drivers frequently encounter parking shortage and have expressed need for improved service (Martin and Warner, 2012). 51% of respondents indicate truck stops were full or too crowded when they liked to park, mostly for overnight parking. The frequency of parking shortage experience was generally high, which nearly 1/3 of respondents encountering shortage situation on a daily basis. It is also worth noting that 48% kept going in such situations. In terms of attitude towards 72% of respondents believed that smart parking would definitely or probably be useful in finding parking at truck stops, while 81% believed smart parking would definitely or probably be useful to the trucking industry overall.

Additionally, studies show that often times even when parking is available, drivers have no knowledge of the availability due to unfamiliarity with the area or previous experience (Sells, 2015).

Some of the most critical issues related to delay of truck parking include: trucker safety, as fatigue is a factor in 16% of truck crashes and 8% of fatal crashes; Illegal parking; air quality and public health issues related to extra diesel emissions; driver productivity lowered due to time lost searching for parking.  
(Martin and Warner, 2012)

### **Description of the Strategy**

There are two smart truck parking projects currently in California. One is the Smart Truck Parking (STP) project conducted by Caltrans; the other is the Reduced Emissions through Efficient Parking for Trucks (REEPT) recently launched by CARB. The two projects are described below. We recommend a more ambitious and coordinated program that would include the entire state and address the truck parking shortage.

#### ***Smart Truck Parking (STP) Project***

The following paragraphs are taken from the research notes of “Program Steering Committee (PSC): Transportation Safety and Mobility” by Hanson M. (2014). It appears that Caltrans was granted FHWA funding to develop a prototype smart truck parking system in California focusing on the I-5.

#### ***Brief Description of Project & Parties Involved***

The Smart Truck Parking (STP) project is a collaborative implementation and research effort among the Federal Highway Administration, Caltrans, the University of California, Berkeley, and other partners. The project, sponsored by the Federal Highway Administration, is designed to demonstrate real-time parking availability at truck stops. The premise is that if you give truckers access to timely accurate information, they will make better travel decisions. Better information will discourage the use of highway ramp idling, enhance safety, and reduce lost time and fuel while truckers search for available parking. Truck drivers will be able to check for real-time parking availability at selected truck stops that are participating in this project on a website or using a mobile device, such as a smart phone or tablet. The project is a five-year pilot with an initial focus on the I-5 corridor in California.

There are three phases to the project:

1. Systems Engineering and development and deployment of a prototype smart truck parking system that includes truck parking availability from two sites;
2. Expansion of the system to six additional sites;
3. Evaluate system performance and economic sustainability

The overall goal is the development of truck parking system that will help to better manage existing truck parking spaces by providing accurate and timely information to truckers.

#### ***What Does It Do & How Does It Do It***

This project will demonstrate and evaluate an ITS-based solution to address parking shortages that exist for long haul truck drivers, provide truckers access to real-time parking availability



and the options to make parking reservations, and investigate and develop a self-sustaining business model that can be scaled and made available at truck stops across the country.

The smart truck parking system has four major components:

Truck parking space availability information systems at truck parking facilities;

1. An aggregator that collects and stores the truck counts and space availability for the sites that generate this information;
2. A database of truck parking facility attributes for the truck stops and rest areas along the I-5 corridor including SR 99; and
3. A web-based user interface that allows truck drivers and fleet operators to access truck parking information from a computer or mobile device such as a smartphone

### ***Reduced Emissions through Efficient Parking for Trucks (REEPT)***

In November 2015, Truck Smart Parking Services, Inc. submitted a pilot project to the California Air Resources Board. Similar to the Smart Truck Parking (STP) project, Reduced Emissions through Efficient Parking for Trucks (REEPT) will locate on the I-5 initially at ten locations. REEPT will target these problems and costs through a strategy that builds on existing and proven intelligent transportation technologies and services (ITS), and installs a network that connects locations where trucks park to meet HOS regulations. This network will serve as the backbone for a statewide service that will optimize commercial vehicle productivity, meet HOS requirements, and reduce GHG emissions. The network will achieve the following:

1. Enable delivery of real-time parking availability and reservations;
2. Incorporate real-time information with HOS requirements to predict parking location availability for truck drivers and routes;
3. Connect to ports and terminals to alert drivers of parking opportunities, and;
4. Ultimately, provide an optional trip planning service for shippers and truckers using big data analytics.

REEPT will collect and transfer real-time parking availability, real-time traffic, trucker HOS requirement, terminal queuing, and trucker/shipper origin and destination data to the cloud. Real-time parking availability and traffic information will be wirelessly communicated to variable message signs (VMS), websites, and/or smart phone apps. Big data analytics will produce a number of services including parking reservations, predictive parking, predictive traffic, and terminal arrival times. All the data and services integrated by REEPT will provide truckers guaranteed parking to ensure adequate rest AND the shortest possible travel times, including routes, departure times, and avoided queuing at terminals (Sells, 2015).

### ***Statewide, integrated smart parking***

In order to be as effective as possible, a smart parking system must be statewide, use common technology, and address the state's parking shortage. The I-5 survey results document a serious safety problem, if nearly half of all truckers who reach the HOS limit continue driving because there is no place to park. If there is no parking and truckers abide by the HOS rules,

they have little choice but to park illegally, often on highway shoulders. A comprehensive study to determine how to address this problem and an implementation plan, if not done already, should be a top priority. The study should include the entire state, meaning within and outside the major metropolitan areas. Within metropolitan areas, port-area satellite parking and staging areas should also be considered.

Integrated smart parking requires a common information and technology platform so that truckers will need only one “app” to access all parking options, public or private. It would appear that currently there are at least two platforms in development. If truckers must invest in learning and using multiple systems, they are less likely to use them at all. Integration is important as the heavy duty vehicle fleet changes; it will be important to distribute power stations, etc., according to demand, and to make such information easily accessible.

Given the extent of implementation in other states, it appears that California could accelerate its current programs, moving much more quickly to statewide scale.

### **Expected Benefits**

Potential benefits of smart truck parking are reflected mainly in three aspects: safety benefits, economic benefits, and environmental benefits. With regard to safety benefits, smart truck parking allows for safe parking decisions while reducing fatigue related crashes. It also removes trucks from ramps and shoulders to avoid illegal parking and related safety hazards. In terms of economic benefits, since drivers and carriers are more efficient, profitability of companies are likely to increase. In addition, business for truck stops would also grow. Last but not least, the greatest environmental benefit would be reduction in greenhouse gas emissions and energy consumption, as 2 gallons of diesel can be saved with 15 minutes less of truck driving (Miller and Morris, 2015).

A smart truck parking precedent in Michigan along the I-94 suggests considerable economic and environmental benefits. In that specific case, with the average operating cost of a truck nearly \$120 per hour, saving each truck driver 15 minutes during their regular parking routine could save \$4.4 billion each year across the 400,000 parking events that occur daily. Moreover, each driver could save two gallons of diesel and reduce greenhouse emissions by nearly 45 pounds per parking search, more than 3.3 million tons of CO<sub>2</sub> each year (O’Connell J., 2014).

In the specific case of California, a smart truck parking system can also help improve the state’s competitive edge in freight transportation. With one of the highest truck volumes and one of the worst parking shortages in the U.S., California incurs over \$1 billion in yearly costs from parking-search travel, fatigue-related truck crashes, and terminal queuing and idling, which significantly reduce the competitiveness of California ports. . In order to keep freight transportation competitive, it is necessary to invest in new technology and services to optimize routing and parking options for trucks to maximize the use of existing resources and minimize truck transportation costs to both the industry and society (Sells, 2015).

## **Expected Costs**

As reported in the Mid-America Freight Coalition TPMS Synthesis (Perry, Oberhart and Wagner, 2015) 2015), the costs to implement truck parking management systems ranged between \$2.04 million (Minnesota) to \$4.4 million (Michigan) and \$4.8 million (I-95 corridor). Detailed costs of the Michigan include: \$1,711,055.00 for detection, \$616,450.00 for communication, \$2,080,719.00 for other costs. The project's annual maintenance cost include: \$247,500.00 for detection, \$20,315.00 for communication.

In the proposed REEPT project for California, the expected total cost is comparable to that of the Michigan project. It will cost \$4.8 million at 10 locations over 3 years to install REEPT, establish the network; provide system enhancements, operate and maintain the system and network for two years after launch, develop and perform third party evaluations, and recruit users through an aggressive public relations and outreach campaign. In addition, REEPT will provide in-kind support of between \$1 and 2 million in licensing and labor. Additional data services defined and developed during years two and three will support operational expenses (Sells, 2015).

## **Role of the Public Sector**

A major role of the public sector, in particular the federal and state authorities, is to provide leadership in establishing a regional smart truck parking system. All previously mentioned examples (proposed or implemented) of statewide smart truck parking required the leadership from state transportation authorities (MDOT-Michigan, Caltrans-California, etc.) and the support from FHWA. It may be the most effective and efficient for the government to lead such projects. Although installation, operation and management of a smart truck parking system can be done by a private firm with the expertise (TSPS, ParkingCarma, etc.), it is still necessary for the public sector to be involved in the process.

Another important role that the public sector plays is to provide funding. For instance, USDOT announced in October 2015 a \$25 million grant to the Regional Truck Parking Information and Management System Project to implement technology that alerts drivers to available truck parking in eight Midwestern states (CCJ Staff, 2015). In the case of REEPT in California, it also notes that the proposed project needs government funding for initial installation and operations. The level of funding could be reduced by support from interagency partners to assist with outreach and the marketing of system availability. REEPT will become the foundation for other services that generate revenues. Signs on any government facilities will be the responsibility of the agency to acquire and install. REEPT will provide connectivity and data feeds (Sells, 2015).

## **Implementation Challenges**

There are several implementation challenges to a statewide smart truck parking system. First, California currently has a mix of public and private truck parking facilities that are managed and operated differently. A statewide system would require establishment of standards and oversight, as well as participation in a single information system, or interoperable systems.

Second, there is a question regarding the state’s capacity to lead and contribute to funding a major technology development and implementation project.

Third, the truck parking shortage is so severe, especially near or within the major metropolitan areas, that increasing the supply of parking would have to be part of any smart parking plan. There are innovations emerging in response to the shortage, such as logistics facilities providing overnight parking; these would have to be incorporated into the smart parking information system. Fourth, charging for parking is likely to be necessary to generate the funds to operate a smart parking system. Truckers may be reticent to pay for parking, and without sufficient enforcement may park illegally rather than pay. Thus incentives would need to be developed, for example security and specialized services.

### Measuring Success

At the moment, most states only collect data about crashes and fatalities. The handful of states that already collect customer satisfaction information could easily develop a customer segmentation approach to address truck operator satisfaction and use with a truck smart parking system. States wishing to pursue such a system should establish measures prior to system design and implementation. Baseline levels for these measures should be collected before a system is implemented.

Recommended performance measures include:

- Level of awareness of facilities
- Acceptance and use of parking information system
- Changes in search time and difficulty in locating parking
- Changes in truck-related crashes
- Changes in illegal parking
- Changes of utilization of parking facilities

Table 2 below provides a more detailed explanation of the metrics.

**Table 2 Truck Parking Performance Measures (Perry, Oberhart and Wagner, 2015)**

Measure	Importance	Data Requirement	Collection Strategy	Difficulty
Level of awareness, acceptance and use of TPMS	★★★★	Truck drivers' attitudes toward system	Questionnaires at parking facilities	★★★★
Change in parking search time and difficulty	★★★★★	Parking search time	Questionnaires at parking facilities	★★★★
Changes in truck-related crashes and fatalities	★★★★	Truck-related crash and fatality records	Police crash reports	★★
Changes in amount of illegal parking	★★★	Number of illegally-parked trucks	On-road observations	★★★
Change in utilization of facilities in system	★★★	Count of trucks parked	Automatic counting via detection tech	★★★★

## **PUSH FREIGHT TRAFFIC INFORMATION SYSTEM**

### **Statement of the Problem**

Freight shipment reflects positive growth, and through the last few years, globalization, competitive industry trends, and new technologies are all pushing freight volumes up in throughout the U.S. For example, in Washington, freight has grown twice as fast as its overall population and traffic growth (Washington State Department of Transportation, n.d.). California (especially Southern California) is home to the nation's largest container port complex, a major air cargo center, a West Coast rail hub, and numerous regional distribution centers.

As the second largest metropolitan area in the U.S., Southern California also represents one of the largest local markets for freight services in the country. Regional and local distribution, domestic trade and national distribution, and international trade all contribute to the increasing volume of freight movement in the Greater Los Angeles area: Based on the Freight Analysis Framework, FHWA estimated that over 223 million tons of freight were shipped internally within the Southern California region – approximately 30 percent of the total freight shipped in the region; Southern California is also one of the leading manufacturing centers in the nation, generating shipments for domestic trade with the rest of the U.S; Shipments between Southern California and the rest of the country account for 447 million tons, or over 60 percent of freight shipped in the region. Southern California is also a large gateway for international trade. Over 11 percent of the nation's trade (by value) passes through the region and it collects over 37 percent of the nation's import duties.

As a major population and employment growth region, Southern California is facing great demand growth for freight transportation services, too. According to the Southern California Association of Governments, freight transportation demand is expected to grow by 80 percent between 1995 and 2020, which would further lead to congestion and air quality issues. (Federal Highway Administration, n.d.)

At the same time, freight has its own travel difficulties: truckers are faced with many restrictions like height, weight, length, width, roundabouts, etc. and their travel affected by weather and construction conditions. Real-time or near real-time traffic information is widely available, but most of the time there's no specific sites for truckers to obtain freight-specific information, not to mention that access usually requires action on the part of the traveler. As a result, the trucking community is not fully aware of the available traveler information that is already available. (Freight Mobility Strategic Investment Board and Washington State Department of Transportation, 2008)

### **Description of the Strategy**

A push information system is a subscriber system: All trucks licensed to do business could enroll in a "freight advisory service", which would push out relevant traffic information as it becomes available, rather than having the trucker "pull" or seek out such information. A push system seeks to reduce travel time by alerting truckers on rail crossing, accident or other delays, and on

road closures, weather alerts, etc. A more sophisticated system that allows for real-time truck location communication could also provide alerts for oversized trucks and loads regarding routes. Some states have set some good examples in providing freight-specific traveler information and taking the lead to develop “push information systems” for truckers.

Washington developed “Freight Alerts”, which is an automated e-mail and text message system that sends notification to subscribers about high value predictive information that allows them to plan their routes, staffing and equipment needs, and stage inventory. This system informs freight shippers and carriers on what will happen to freight corridors during planned construction disruptions, and during unplanned, emergency disruptions. (Washington State Department of Transportation, 2013)

WSDOT developed this system in 2007 and implemented it in 2009. Individuals can sign up to receive e-mail on the status of closures and other activities affecting freight, and by 2014, 30000 people have signed up. The alert system has been an effective practice for enhancing communications within this distinct and important sector. (Baglin, 2014) The following information is covered by this notification system: Permits for oversized and overweight vehicles; Information related to the legal weight limits and calculators to determine truck weights; Information to obtain a transponder to bypass state weight stations through the Commercial Vehicle Information System and Networks (CVISN); News related to major construction; Links to traveler information for the three-state I-5 Corridor. (Freight Mobility Strategic Investment Board and Washington State Department of Transportation, 2008)

Minnesota has a one-stop-shop site for truckers to get restriction information specifically tailored for freight. It is imbedded in the 511 website (<http://tr.511mn.org/index.jsp>), and includes information on winter driving, road reports, restrictions, and weather stations. It has a similar feature of a “push information system” called “Personalize Your 511” that allows users to create up to 20 various routes and get e-mail and text message alerts.

CommuterLink is Utah’s Intelligent Transportation System (ITS), which is a network of resources designed to maximize the efficiency of transportation in the state and help residents “Know Before You Go” a transportation services information program designed to keep travelers updated about road conditions and delays (Cisco Systems Inc., 2004). It enables registered users to receive notification alerts of incidents on freeways. The alerts can be sent to any device capable of receiving e-mail or text messages, such as personal computers, cellular phones, PDAs, and text pagers. Users can customize their alert profiles by indicating the type of incidents they are interested in and the time of day they want to receive alerts. (Kimley-Horn and Assoc., Inc. and Cambridge Systematics, Inc., 2009)

Components of a push information system are as the following graph shows (Figure 8). The information source provides new data for a specific channel to the broadcaster. The broadcaster applies filters on the data to limit data transfers and sends the data (in parallel or iteratively) to a set of repeaters (for scalability reasons) for which the filters succeeded. The repeaters then redistribute the data to receivers. For higher scalability, additional levels of repeaters may be necessary. Every broadcaster can send to multiple channels and every

receiver can receive from multiple channels. In Figure 8 some of the arcs representing channels and backchannels cut through components of the transport system to motivate that these components are necessary for scalability purposes but are transparent to the channels and the dissemination process. (Hauswirth and Jazayeri, 1999)

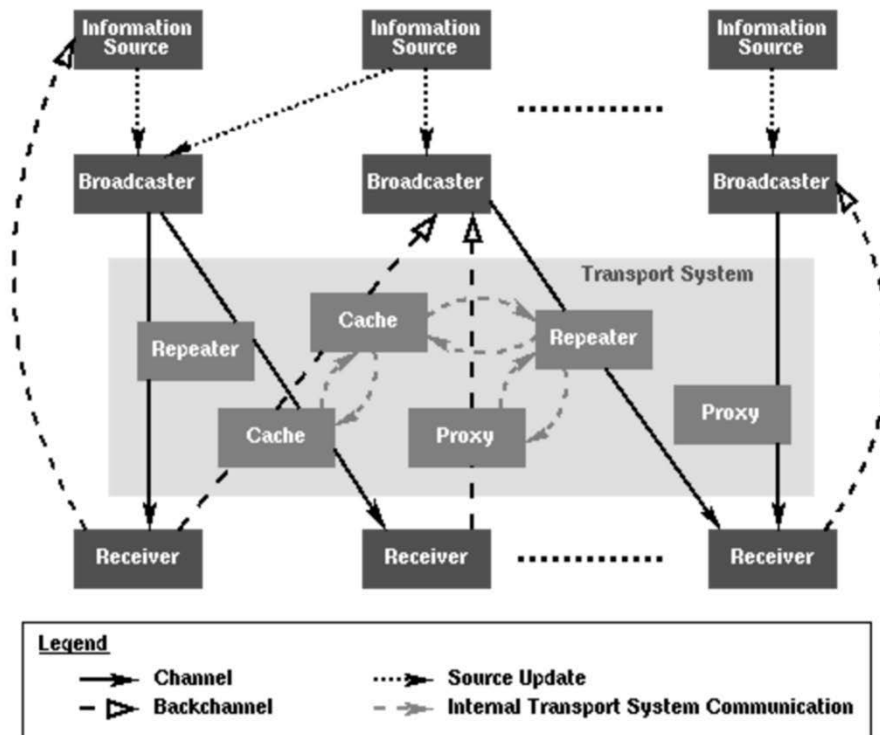

**Figure 8 Components of Push Information System (Source: XXXXX)**

To build such a freight push information system, the following data would be necessary: Location of roads; Status of roads (e.g., road quality or temporary construction on the roads); Types of vehicles that can utilize the road; Limitations and congestion; Real-time information (congestion, accident, etc.). (Ranaiefar, 2012)

### Expected Benefits

A push information system for freight is beneficial: It provides easier access for truckers with relevant information; It minimizes traffic by helping freight avoid construction areas; It also minimizes additional traffic disruptions by avoiding oversize/over-height/over-width loads that might add more delays or problems; It improves truck mobility by increasing knowledge of construction activity, incidents, and border congestion that allows trucks to plan routes and schedule travel; It reduces local impacts; It also improves safety by increasing compliance with weight and permitting restrictions. (Washington State Department of Transportation, 2008)

Based on ITS successes in other cities, UDOT developed three primary goals for the ‘Know Before You Go’ initiative. First they wanted to reduce freeway delays by 20 percent, increase peak-hour freeway speeds by 15 percent, and reduce signal stops and intersection delays by 20 percent. Second, they wanted to enable emergency personnel to identify and respond quicker to traffic incidents. And third, they wanted to provide traffic, weather, and accident information to Utah travelers via radio, television, the UDOT Website, electronic message signs, and a toll-free telephone travel information line. (Cisco Systems Inc., 2004)

### **Expected Costs**

Washington State’s Freight Alerts system’s cost estimate is \$380,000, and it requires 1 Full-time Equivalent (FTE) to consolidate and maintain web-based information, and 1/2 FTE to develop and implement training program for trucking industry. (Washington State Department of Transportation, 2008)

Utah DOT spent approximately \$1 million initially to develop the ATMS and ATIS software that form the core of CommuterLink. Annual software support costs for CommuterLink are approximately \$50,000. The 511 phone system costs approximately \$275,000 annually in usage charges. UDOT has six full-time staff dedicated to operating and maintaining CommuterLink at UDOT’s TOC. UDOT periodically implements enhancements to CommuterLink. The cost of designing and implementing these enhancements varies, but it is typically in the \$200,000 to \$300,000 range. UDOT spent \$50,000 setting up the mobile web capabilities and has a \$25,000 annual maintenance contract. (Kimley-Horn and Assoc., Inc. and Cambridge Systematics, Inc., 2009)

Minnesota’s Trucker Info’s upfront cost is \$150,000, and annual maintenance and operations cost is \$10,000.

### **Role of the Public Sector**

The state government has the responsibility to ensure the provision of traveler information to the public, especially information that will assist in preventing, avoiding or minimizing travel-related crashes and incidents, and make sure that the transportation system operates efficiently, especially in terms of reducing congestion and delay. (Minnesota State Department of Transportation, n.d.) The State DOT should also encourage the development of public/private sector partnerships, for example, WSDOT is currently contracting with a third-party subscription alert system that could be used to disseminate truck information. (Washington State Department of Transportation, 2008) The State DOT should provide funding for development and operations for the strategy, too. And finally, the government should also plan an outreach and public information effort to inform the trucking industry of the tools and information available.

### **Implementation Challenges**

The freight push information system is a relatively simple concept, and there are examples in other states to help guide an implementation plan. The state of California, through Caltrans,



state highway patrol, and state emergency services have the information that would be part of a push system. Most of this information is available now on websites or via 511 services. Thus the main challenge would be developing the system and finding the funds to pay for it. Longer term, the system could be expanded beyond the state highway network. In addition, the push system could become of a larger freight information platform, as discussed in the next strategy section.

### **Measuring Success**

Several metrics could be used to measure the success of this strategy. Travel Time Delay is an important measure, as the main purpose of this strategy is to provide better access to information and reduce congestion. Connectivity is another useful measure, since the ultimate goal is to increase connectivity and efficiency. Crashes – Truck and Reliability is also a good measure as it is focused on safety issues. Emission measures the eco-efficiency of the strategy, and is meaningful in the long run. (Alameda County Goods Movement Plan Task 4B: Strategies Evaluation)

## **STATEWIDE FREIGHT INFORMATION PLATFORM**

### **Statement of the Problem**

Freight trucks serve the important function of delivering goods to communities. Often these communities plan their transportation networks without freight in mind. Conflicts with land use and design burden the trucking industry in regards to routing. (United States Department of Transportation, 2012) Communities want to separate freight activity from residential uses. They also design roads for personal vehicles, bicycles, pedestrians, and even transit but disregard freight compatibility. As a result many roads are not suitable for large trucks. Communities legislate which roads truck are and are not permitted to navigate. There is pressure on the industry side as well, for example the Port of Los Angeles has language on their concession agreement requiring licensed motor carriers to abide local truck route and prohibitions. (Port of Los Angeles, 2016) Carriers in violation could face penalties that can have devastating impact on their already thin margins.

The process of avoiding restricted routes can be costly as well. Searching for legal routes has many of the same drawbacks of searching for parking. Delay in delivery because of route searching increases VMT and emissions compared to an optimized route. (Suzuki, 2011) Time lost searching is a burden for multi-destination freight trips. Even when a route is not labeled as restricted a driver may find that the design of the road geometry may not be suitable due to clearance over head or at intersections. Oversight in signage or policy on part of the community may lead to damaged property due to inadequate turning radius or low clearance on bridges. This uncertainty can hinder real time routing efforts if the data on which it is based is not reliable.

Institutional and Informational barriers to truck route data exist. In California CALTRANS hosts state level trucking information for the state as a whole. However they can only advise to

contact local municipalities regarding the existence and location of legal truck routes through municipalities. (CALTRANSa, 2016) Even then, many cities in California do not have easily accessible route maps or information on their websites. (CALTRANSb, 2016) The only method available is to confirm the existence of a truck route on-site which leads to inefficiencies.

### **Description of the Strategy**

Resolving the local route dilemma will require a statewide effort. Other states have already pioneered efforts to resolve these issues. Illinois and Connecticut for example have centralized truck route information. Florida passed legislation that ensure land use and design compatibility of local truck routes. Lessons can be learned from these states to develop a strategy for California.

In Connecticut the state legislates truck prohibitions. (CTDOT, 2012) The head authority on this matter is the state traffic administration OSTA. They have jurisdiction over every city, town or borough within the state in regards to freight traffic. Municipalities must request non-delivery truck prohibitions from the Executive Director of the OSTA for review and consideration. OSTA initiates an investigation and informs the municipality of their findings. The municipality must be in agreement before a through truck prohibition is enacted. The state maintains a list of roads with truck prohibitions in pdf format. (OSTA, 2012)

In 2012 Illinois required local public agencies to report all local truck routes under their jurisdiction to the state DOT. (Illinois General Assembly, 2012) The DOT is responsible for the collection and publishing of the data. Currently the DOT displays the data on their website in the form of an ESRI hosted map. (Illinois Department of Transportation, 2016) This map contains permitted truck routes at the state and local levels all in one location.

Florida took another approach to protect existing truck routes. In 1995 the state passed legislation requiring the creation of corridor management plans. (The Florida Senate, 2016) These plans are administered locally and require the city to map and protect truck routes by checking developments/road improvements for compatibility. Any changes to the transportation corridors that could negatively impact freight compatibility were to be reported to FDOT. (Williams & Frey, 2003) While this only applied to major truck routes it demonstrates a method by which local municipalities were made accountable to catalog and ensure exiting routes stay accessible.

California could adopt a hybrid strategy that can take portions of what these states have done. The state of California does have the challenge of a large population and geography. Data gathering will likely be best carried out at the regional level. In order to be cost effective, the data gathering should be coupled with an existing data gathering process. An existing practice that could incorporate truck route data could be through Regional Transportation Plans. The guidelines for RTPs call for a Goods Movement element. (California Transportation Commission, 2010) This element could incorporate plans on preserving and identifying truck routes. A map of local truck routes would be a natural addition. Lead agencies would then pass the data to the state, specifically CALTRANS.

It may be noted that the information platform for routes could be extended to other types of information and could be linked with the push information system described in the previous section. Should these recommendations be implemented, coordination would be helpful.

### **Role of the Public Sector**

Local municipalities will need to dedicate some effort into collecting their truck route regulations into a deliverable format. Currently, cities have publicly available data in various formats. Some have it only in their municipal code as text, others as a pdf image in their general plan. The standardization could take place at the local level or the lead agencies over RTPs can take on that task. Shapefiles with attributes specifying restrictions details such as weight, type, height, or axels would be adequate.

Once the local data is centrally located along with the state level data there are a couple of strategies that can be taken to distribute it. The simplest approach is taking the open data approach. The hope is that private entities take the raw data and incorporate it into applications that can be used by freight carriers in routing. Alternatively CALTRANS could develop the routing platform themselves or bundle it with other freight services.

### **Expected Benefits**

Having local route information will effectively address the issues of route searching and re-routing. Carriers can confidently optimize their routes and minimize VMT. Efficient routes could have modest emissions reductions. (Robinson & Foytik, 2014) Reduction in violations fines will reduce operating costs. Additionally hazardous freight can be safely navigated through proper routes.

### **Expected Costs**

Expected costs can be kept to a minimum. By appending the data gathering process to an existing practice, only additional labor hours will be needed to meet the objective. Conversely legislating a new mandate could be costly in time and drafting. Data hosting costs are variable depending on the format. FTP would be cost effective while having a visual tool to go along with it would be less so. A hosted map with visual capabilities, similar to the one Illinois has, cost varies depending on the licensing agreement CALTRANS has with mapping services. Developing a custom routing application again varies depending on software development contracts but certain types can cost hundreds of thousands. (USDOT Intelligent Transportation System Joint Program Office, 2016)

### **Implementation Challenges**

There are a few challenges to implementation. First, providing data for public use requires reliability. Information that is outdated, incorrect or incomplete undermines the goal of the endeavor. There could be legal liability where carriers following route data provided in good faith but are fined for a local violation. A disclaimer should be provided similar to that of Illinois web service. (Illinois Department of Transportation, 2016) Second, the data must be consistent. Municipalities may have differing definitions in their legal codes as to permit vehicle types. Having a unified statewide coding convention for truck routes can reduce errors and mistakes in

routing. Third, given the fiscal constraints facing local governments, cities may resist a mandate from the state, and/or seek reimbursement for any costs associated with providing the information.

### **Measuring Success**

To measure the success of the effort we can look at a couple of metrics. This system is expected to improve efficiency. Those saving should be evident in the financial saving of freight carriers. Optimal routing reduces VMT and travel time while increasing productivity. Tracking these changes in the financials of trucking firms could provide insight. Alternatively we can track the loss revenue of cities due to increased truck compliance. However possibly the best way is to use GPS technology to measure impacts before and after implementation. There are priors to using such a method to measure the success of freight infrastructure improvements. (McCormack & Hallenbeck, 2006)

## **BORDER REGION ITS STRATEGY**

### **Statement of the Problem**

The San Diego Association of Governments (SANDAG), working in partnership with U.S. Customs and Border Protection (CBP), the U.S. Department of Transportation (USDOT), the California Department of Transportation (Caltrans) and the U.S. General Services Administration (GSA), is undertaking the State Route 11 (SR11) and Otay Mesa East (OME) Port of Entry (POE) project. Mexican government agencies are advancing the companion project known as Mesa de Otay II POE and connecting roadways, which will develop a border crossing facility in Mexico as a partner to the new OME POE.

The purpose of this project is to decrease wait times, alleviate border traffic congestion, and reduce emissions by adding capacity to the regional border-crossing infrastructure<sup>1</sup>. This project would create a link between the U.S. regional highway system and roadway system in Mexico. This link will ensure the continued flow of \$39B in cross border trade (2014) through the California/Baja California region. The need for this project is clear since trade and travel in this area is forecasted to continue to grow rapidly in the region and border delays are expected to increase correspondingly. These delays have economic impacts at the regional, state, and national levels.

### ***The SR11 Project***

The goal of the project is to reduce delays caused by traffic congestion and associated impacts while also accommodating projected trade and travel demand. This project will subsequently stimulate economic growth and job opportunities on both sides of the border.

To meet this goal, the vision for the project, is to develop a new cross-border facility and associated transportation facility, SR11, which will be a “state-of-the-art” border-crossing

---

<sup>1</sup> There are currently three ports of entry in the region: San Ysidro, Otay Mesa and Tecate. Otay Mesa East will be the fourth.

facility. The proposed POE facility will be located approximately two miles east of the current OME POE and will ultimately be the third border crossing along the San Diego region's border with Tijuana, as well as the fourth crossing between Mexico and San Diego County.

Key objectives of the proposed POE include:

- Optimizing the efficiency of the new POE by using state-of-the-art ITS and cutting-edge operating concepts.
- Financing the facility through self-sustaining cash flows derived primarily through tolls.
- Integrating a toll-pricing demand management model at the border that is based on crossing time and focused on congestion management and emissions reduction.
- Designing the project as a national model of public/public partnering.
- Developing a project that serves as an example for both environmental and economic benefits.

### **Description of the Strategy**

The ITS strategy will serve three primary purposes.

- First it will provide the underlying infrastructure and hardware and software applications to support entire toll collection system for the new port of entry. This will be developed through a Concept of Operations (ConOps) and establishment of system requirements to feed into the project alternatives analysis, design and implementation stages.
- Second, the ITS strategy through the ConOps and system requirements, will provide the required process and suggested applications (a "blueprint") to be integrated into a Regional Border Management System (RBMS). The RBMS will provide for binational communication and coordinated traffic management between the existing Caltrans Transportation Management Center (TMC) and a new Tijuana/Mexico Regional TMC.
- Lastly, the ITS strategy will involve multiple facets related to enhanced traffic flow (reduced congestion) goals for U.S./Mexico port of entry operations including the management of the lanes used to approach the port of entry and advanced traveler information to be made available directly for users. Advanced technologies to facilitate flow will include license plate reader (LPR), Wi-Fi, RFID, among others with the capability to serve the needs of Customs operations for both the U.S. and Mexico, as well as inform passenger and commercial users about wait times. Other flow enhancements include automated signage and/or changeable constructed barriers to allow for optimal management prior to entering the port of entry.

### ***Other Similar Sustainable Freight Applications Using ITS Advanced Technologies***

Two examples that relate to the Border Region ITS Strategy include the FRATIS demo (greater Los Angeles) project and the existing Interstate 15 Express Lanes in San Diego County. Similar to the FRATIS system, The Border Region ITS Strategy will rely upon the exchange of data and

information between the Caltrans TMC, and newly developed RBMS and Tijuana/Mexico TMC. Concepts as a part of this include traveler information for both passenger and commercial users, messaging signage for all users, as well as potential integration into shipping industries where dispatchers may be involved through the process for commercial activities.

The Interstate 15 Express Lane facility currently utilizes a variable toll system which is priced to facilitate demand management. The I-15 toll road toll transponder technology is integrated with other Southern California regions by the FastTrack technologies. The toll rates vary with traveler demand, and have proven to be effective with congestion management in the region. Users of the system are able to access information to determine the value of their trip based upon a variable toll. This system also serves as part of the region’s Integrated Corridor Management System (ICMS) which has dynamic routing for incident management. Additionally, this I-15 system is integrated into the Caltrans TMC with all other Interstate/Highway facilities. The combined experience of SANDAG and Caltrans District 11 for tolling and TMC operations will be leveraged for the regional border systems directly through the Border Region ITS Strategy.

### Expected Benefits

The travel environment that exists in the San Diego border region is unpredictable and time consuming with wait times as long as over two to three hours. The Border Region ITS will serve as a critical component for the goal of achieving a 20-minute wait time at the new Otay Mesa East border crossing. The added capacity of a new border crossing incorporating the ITS strategy will provide users with an option to efficiently use this extra capacity.

In addition to congestion relief at the border, reductions in greenhouse gas emissions and particulate matter pollutants will potentially be a resulting benefit as passenger and commercial vehicles spend less time idling on the approach roads leading to the POEs.

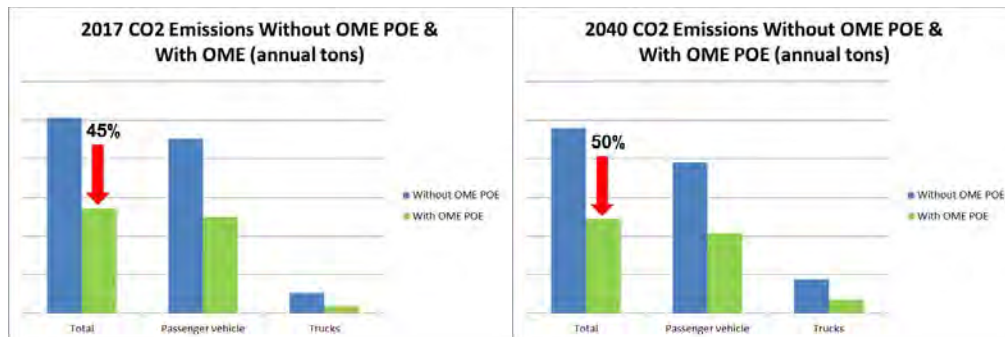

**Anticipated CO2 Reduction Benefits by Border Region ITS Strategy (Source: SANDAG)<sup>2</sup>**

<sup>2</sup>The difference between CO2 emissions is primarily driven by assumptions from implementing the SR 11 facility and OME new border crossing. This is due to the fact that the Traffic & Revenue Study assumes a rate of traffic diversion that occurs once the new POE is operational. This diversion rate reduces the number of passenger and commercial vehicles crossing at San Ysidro and Otay Mesa which reduces the respective existing delays at those crossings. The SR 11 OME border crossings provides new capacity, which is managed by a toll system which generates a wait time much lower than the existing border crossing delays. In addition to the diversion and estimated travel time savings, idling emission rates were used from the 2008 EPA report below. Combined there is a systemwide reduction of CO2 emissions.



At the binational level there is a Memorandum of Understanding signed in July 2014 between Mexico and California and binational, multi-agency oversight committee has been formed to expedite the Border Region ITS Strategy and ultimate construction of the SR 11/Otay Mesa East Project. The committee held its first meeting in November 2014 and meets regularly to work on key project milestones.

Terms of the federal ITS Pre-deployment Study (USDOT Sponsored) indicate that all the ITS Border Strategy should fully scope intelligent systems on both the US and MX side of the border; it must be fully integrated and coordinated in order to improve traffic flows. Border traffic optimization must occur with bi-national authorities.

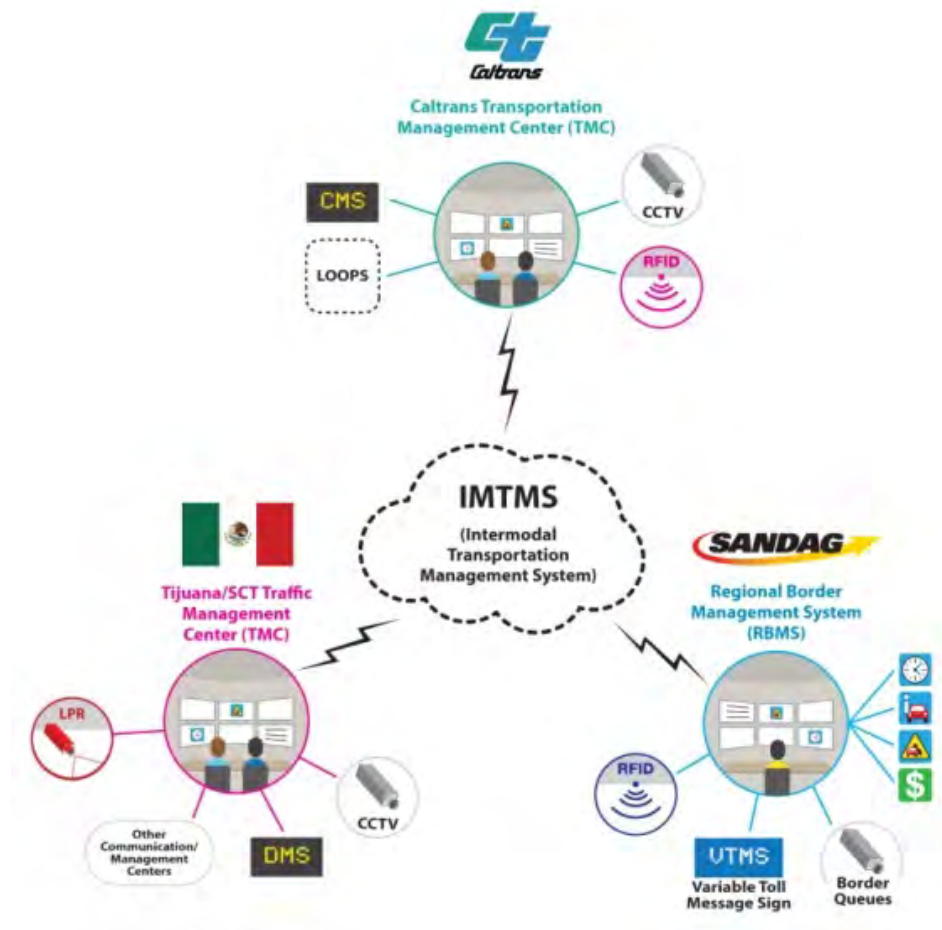

**Figure 10 Basic operation and coordination concept between Regional Border Management System and Traffic Management Centers in US and MX (Source: IBI Group, 2014)**

### Implementation Challenges

As a binational project, there are implementation challenges for the project. These include coordination with local, state and federal partners in the United States, coordination with local, state and federal partners in Mexico, integrated data collection and information sharing across



two different countries, and timely execution and implementation of the project based upon toll revenue generated financing.

Working through all levels of government within the United States is no easy task and the project has many responsibilities to ensure that this process is successful. Duplicating all processes with Mexico is a substantial undertaking and requires significant resources. The bilateral coordination across 30 border related agencies the border requires significant time and resources.

The project has been elevated to the High Level Economic Dialogue at the federal level with support from both the State of California and Mexico; so for all purposes this project has become federalized by both the US and MX. Despite major achievements to date, the remaining schedule of the project will require the same level of effort as the project progresses towards implementation. These risks will be managed until the project is constructed and opened to traffic. The project sponsors will look to build on past success to continue moving the project forward.

### **Measuring Success**

These strategies are aimed at achieving the State's Sustainable Freight objectives (GHG reductions, emissions reductions, economic competitiveness and application of advanced technologies).

The Border Region ITS Strategy will provide for a reduction in travel times which will allow for the opportunity to reduce GHG emissions, while improving the throughput of both passenger and commercial users providing for economic competitiveness. The wait time information which will be provided through the ITS strategy will be able to accurately measure the time it takes users to cross through the border crossing; including from Mexico to the California State Highway system. This information will inform economic competitiveness directly as SANDAG has multiple studies that provide information of the economic impact from border wait times.

Additionally, SANDAG is close to updating the economic impacts from border wait times and will also be looking impacts to GHG. So an updated border wait time study is being launched to provide information for analyzing wait times and their impacts on to both economic competitiveness and GHG emissions.

## **FREIGHT-FOCUSED TRAFFIC MANAGEMENT**

### **Statement of the Problem**

The majority of freight movement in California is made by trucks, which account for a significant portion of traffic on the state's highway systems, especially along major freight corridors such as I-710 and I-5. These freight trucks both cause and suffer from delays due to traffic congestion on highways. They also contribute to and experience traffic congestion on surface streets on their way to pick up and make delivery, especially in urban areas.

There are several traffic management strategies that can mitigate traffic congestion, reduce travel delay, and improve trip time reliability. Most of the strategies in use today are focused on the general needs and characteristics of passenger cars. However, the physical characteristics and operational needs of freight trucks are different from those of passenger cars. Therefore, there are opportunities to improve existing traffic management strategies by giving more consideration to the needs and characteristics of freight trucks, and to develop new freight-focused traffic management strategies that can be deployed in areas where the share of truck traffic is high.

### **Description of the Strategy**

Freight-focused traffic management strategies consider the physical characteristics and operational needs of trucks, and place greater weight on reducing their travel delay for, for example, in signal timing at intersections and ramp meters. Doing so would increase travel efficiency, save fuel, and reduce emissions for both the trucks and the overall traffic. Some freight-focused traffic management strategies can be implemented in the near term with the use of existing technologies. Others that look to take advantage of Connected and Automated Vehicle technologies may take longer time to develop and deploy. Examples of freight-focused traffic management strategies are given below.

#### ***Freight Signal Priority***

Freight signal priority (FSP) allows freight vehicles approaching a traffic signal, at signalized intersections and ramp meters, to request signal priority. It considers the vehicle's location and speed to determine whether priority should be granted. With the Connected Vehicle technology that enables communications between vehicles and infrastructure (e.g., traffic signal), information collected from freight vehicles approaching the traffic signal, such as the vehicle's adherence to its delivery schedule, weight carried, vehicle type (e.g., alternative fuel vehicles), and its fuel consumption and emissions may also be considered in granting priority (see Figure 11). If priority is granted, the traffic signal would turn green sooner or staying green longer, allowing the freight vehicle to pass through more quickly.

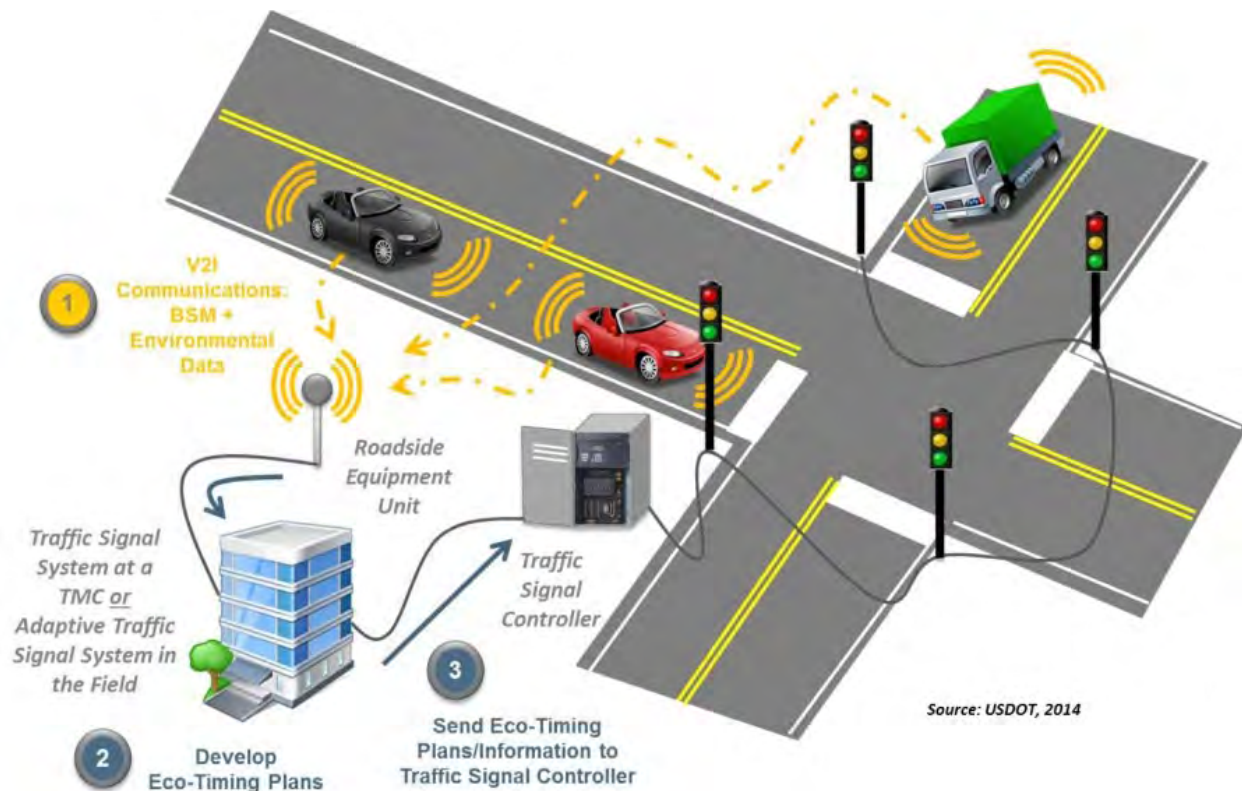

**Figure 11 Freight Signal Priority in Connected Vehicle environment (USDOT, 2014b)**

### **Truck Eco-Routing**

Many existing fleet management systems utilize route planners that minimize travel distance or travel time. A shortest or fastest route is often not the route with lowest fuel consumption or emissions, particularly in areas with hilly terrain or heavy traffic congestion. On the other hand, truck eco-routing calculates the most environmentally friendly travel route for a truck considering its engine size, weight carried, road grade, and real-time traffic condition (Scora et al., 2013). If applicable, it can also take into account time window to ensure that the pick up or delivery will be made on time. Truck eco-routing provides trucking companies and truck drivers with an additional route planning option (see Figure 12), which they can use to improve the efficiency of their trucking operations.

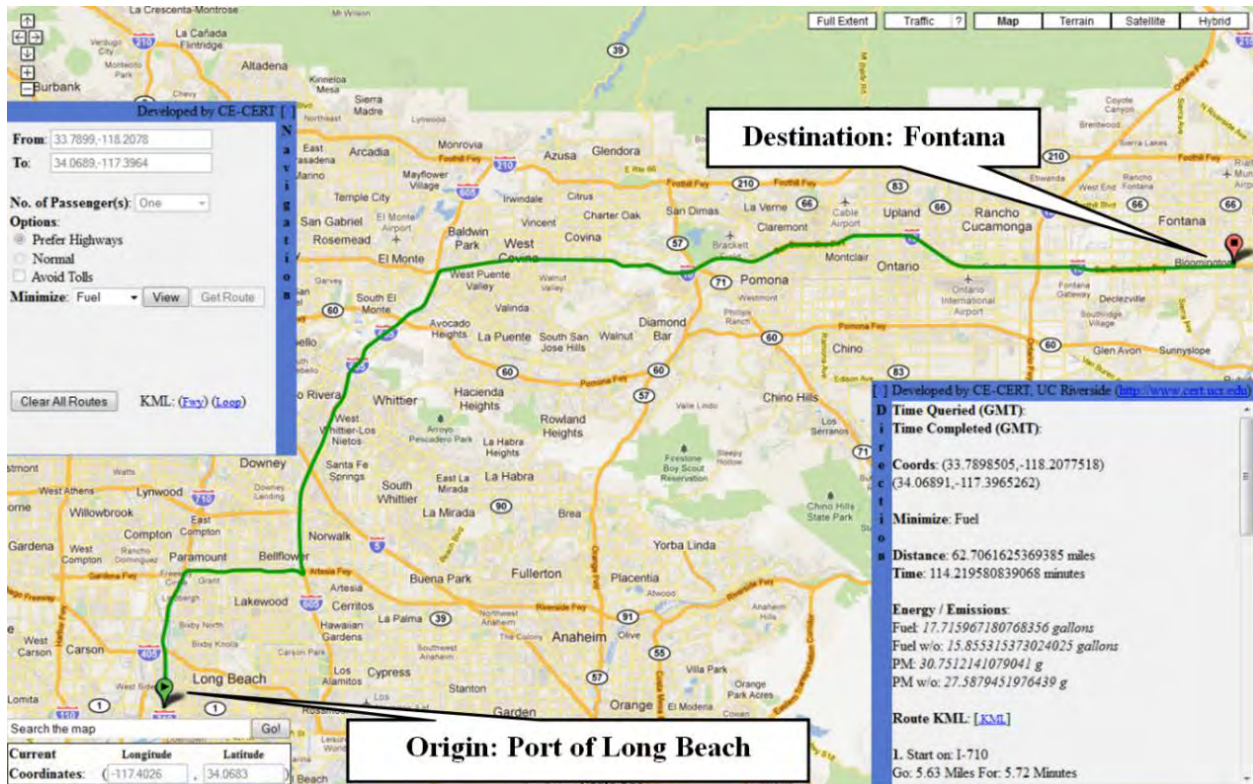

**Figure 12 Truck eco-routing application**

### Expected Benefits

In the case of FSP, a simulation modeling study (Yelchuru et al., 2014) shows that a FSP scheme that is geared towards reducing fuel consumption (referred to as “Eco-FSP”) provides up to 4% fuel savings for freight vehicles that are equipped with Connected Vehicle technology. This is equivalent to \$649,000 annual savings for a fleet of 1,000 delivery vehicles driving 30,000 miles on arterials each year. Another simulation modeling study (Kari et al., 2014) show that Eco-FSP reduces travel delay of freight vehicles equipped with Connected Vehicle technology by up to 26%. This study notes that passenger vehicles and unequipped freight vehicles also gain fuel saving benefits, resulting in a system-wide fuel reduction in the order of 5%-10%.

In the case of truck eco-routing, a comparative evaluation of route options for truck (Scora et al., 2015) shows that on average the most fuel-efficient route could save fuel by 9%-18% compared to the fastest route, but taking 16%-36% longer travel time. Despite such tradeoff, the eco-route option may make economic sense if the truck will still arrive at the destination within the required time window (if any). The eco-route option is especially attractive when the truck carries heavy loads or when the fuel prices are high. Thus, truck drivers or fleets can strategically choose to use truck eco-routing for parts of their operations depending on circumstances.

### Expected Costs

FSP can be implemented with existing technologies that are used in a similar system called transit signal priority, which costs \$8,000 to \$35,000 per signal depending on system design and

functionality, and type of equipment (USDOT, 2002). Note that these estimates were made in 2002 and the technology costs may be much lower at present. Also note that these estimates include the costs for necessary equipment both at the traffic signals and on the vehicles, which in the case of transit signal priority, are typically paid by the transit agency implementing the system. If FSP is to be implemented with Connected Vehicle technology that utilizes Dedicated Short-Range Communication (DSRC) devices, the capital costs would range from \$48,000 to \$51,600 (in 2013 dollars) per traffic signal (USDOT, 2014c) while the annual operations, maintenance, and replacement costs would range from \$1,950 to \$3,050 per traffic signal (USDOT, 2014a). These infrastructure-related costs would likely be paid by the public agency responsible for the traffic signal. On the vehicle side, the capital costs would be around \$4,150 while the annual costs would vary (USDOT, 2014d). These costs are presumably the responsibility of the vehicle owner.

For truck eco-routing, the implementation costs are expected to be minimal. Most truck drivers and truck fleets are already using some forms of route planning system. The eco-routing option would likely be offered by developer as an added feature to the existing route planning system.

### **Role of the Public Sector**

Government agencies at all levels have a significant role to play in the freight-focused traffic management strategies in the same way as in the existing traffic management strategies. As owners of roadway facilities, state and local transportation agencies will manage their facilities in a way that achieves their safety, mobility, and sustainability goals. They will serve as the entity responsible for the planning, design, and implementation as well as the operations and maintenance of the freight-focused traffic management strategies. The federal government will lead research and development of new strategies, coordinate technology transfer activities, and provide financial and technical support for the deployment.

### **Implementation Challenges**

Challenges to the implementation of freight-focused traffic management strategies may include:

- *Finance* – Implementing these strategies will require financial outlays. In the operating environment of many transportation agencies where resources are limited, it may be difficult for freight-focused traffic management projects to compete with other agency needs, especially if freight traffic in the area is not high.
- *Perception* – Since these traffic management strategies are geared towards freight vehicles, there could be perceptions by the general public that their personal mobility is sacrificed. Managing these perceptions could be a challenge.
- *Private-Public Partnership* – Some freight-focused traffic management strategies such as FSP also require an investment by vehicle or fleet owners. Transportation agencies will need to get their buy-in before the implementation.

## Measuring Success

Key performance metrics in measuring the success of freight-focused traffic management strategies include:

- Reduction in travel delay
- Increase in trip time reliability
- Reduction in fuel consumption
- Reductions in vehicle emissions

Data needed for the calculation of these performance metrics will be collected in real-world before and after the implementation of any specific strategies. Note that the performance metrics should be calculated for both freight vehicles and all vehicles in the traffic. It is important that improvements for freight vehicles are not at the cost of other vehicles in the same traffic stream.

## CONCLUSIONS

This white paper has presented eight possible IT strategies to address the Governor's order to increase the efficiency and sustainability of California's freight system. Our approach was to frame the problem as one of delay from congestion or uncertainty. Our goal was to identify strategies that generate eco-efficiencies; strategies that both increase efficiency by reducing delays and generate environmental benefits (reduced fuel consumption and GHG emissions). We organized our strategies around two themes: 1) Information problems in the goods movement supply chain, and 2) Information problems in statewide trucking.

We identified eight strategies that are recommended for consideration of implementation. Because of the short time frame of this study, we relied entirely on the existing literature. Some strategies have been tested and studied more than others, hence the information presented here varies from one strategy to another. In no case was there sufficient information to quantify the costs or benefits of implementing the strategy as discussed in this paper. All strategies require additional study before their contribution to efficiency or GHG reduction can be estimated.

Our assessment of the eight strategies are summarized in Table 3 below. Our assessment criteria include cost, implementation time frame, degree of difficulty, potential for efficiency gains, and potential for GHG reductions. We use general rankings of high, medium, and low, except for implementation time frame. All assessments are relative to one another (e.g. "high" means high relative to the other strategies). We stress that these are highly subjective ratings based on very limited information. In general, the highest cost strategies have the longest time frames, the most challenges, and the greatest potential gains. The lowest cost strategies are easier to implement, but due to their limited nature are not expected to have major impacts on efficiency or GHG reductions. These strategies provide a useful starting point for developing a statewide freight efficiency program to achieve California's efficiency goals.

**Table 3: Assessment of IT Strategies**

Strategy	FRATIS	Appts	Load tracking	Smart parking	Push info system	Info platform	ITS border	Traffic mgmt
Criterion								
Cost	M+	M-	H	H	L	M-	M+	H
Time	3-5	1-3	5-10	5	1-3	1-3	3-4	5-10
Difficulty	M	M	H	M	M-	M-	M+	M+
Efficiency	H	M	M	M	M	M-	M+	M+
GHGs	M	M	H	M	M-	L	M+	M

## References

Baglin, C. (2014). Response to Extreme Weather Impacts on Transportation Systems. NCHRP Synthesis 454. Retrieved from [http://onlinepubs.trb.org/onlinepubs/nchrp/nchrp\\_syn\\_454.pdf](http://onlinepubs.trb.org/onlinepubs/nchrp/nchrp_syn_454.pdf)

Baglin, C. (2014). Response to Extreme Weather Impacts on Transportation Systems. NCHRP Synthesis 454. Retrieved from [http://onlinepubs.trb.org/onlinepubs/nchrp/nchrp\\_syn\\_454.pdf](http://onlinepubs.trb.org/onlinepubs/nchrp/nchrp_syn_454.pdf)

Barnard, B. (2014, July 28). Congestion worsens at Rotterdam, spreads to Antwerp. Journal of Commerce.

Bonney, J. (2015, August 28). LALB port truckers: Terminal appointments must be backed by data. Journal of Commerce.

Bonney, J. (2015, June 7). New Orleans can offer lesson in truck appointment systems. Journal of Commerce.

Butler R. (2014). Using Freight Advanced Traveler Information Systems to Promote Urban Freight Mobility. Presented in FHWA TalkingFreight Seminar. Retrieved from [http://www.fhwa.dot.gov/planning/freight\\_planning/talking\\_freight/july\\_2014/talkingfreight07\\_16\\_14rb.pdf](http://www.fhwa.dot.gov/planning/freight_planning/talking_freight/july_2014/talkingfreight07_16_14rb.pdf)

California Department of Transportation. (2012) Fast Freight Facts: Commercial Vehicles (Trucks). California Department of Transportation. Retrieved from: [http://www.dot.ca.gov/hq/tpp/offices/ogm/fact\\_sheets/Fast\\_Freight\\_Facts\\_Trucks\\_bk\\_040612.pdf](http://www.dot.ca.gov/hq/tpp/offices/ogm/fact_sheets/Fast_Freight_Facts_Trucks_bk_040612.pdf)

Caltrans, University of California, Berkeley, Parking Carma and NAVTEQ. (2011). Smart Truck Parking – Improving the Parking Experience. Retrieved from: [http://tsrc.berkeley.edu/sites/default/files/ITS%20World\\_Smart%20Truck%20Parking.pdf](http://tsrc.berkeley.edu/sites/default/files/ITS%20World_Smart%20Truck%20Parking.pdf)

Cambridge Systematics, Inc. (2015) Alameda County Goods Movement Plan Taks 4B: Strategies Evaluation. Prepared for Alameda County Transportation Commission. Retrieved from [http://www.alamedactc.org/files/managed/Document/17391/FR2\\_AlamedaCTC\\_GoodsMvmt\\_DvlpStrtgs\\_Task4b\\_20151027.pdf](http://www.alamedactc.org/files/managed/Document/17391/FR2_AlamedaCTC_GoodsMvmt_DvlpStrtgs_Task4b_20151027.pdf)

Cambridge Systematics, Inc. (2015) Alameda County Goods Movement Plan Taks 4B: Strategies Evaluation. Prepared for Alameda County Transportation Commission. Retrieved from [http://www.alamedactc.org/files/managed/Document/17391/FR2\\_AlamedaCTC\\_GoodsMvmt\\_DvlpStrtgs\\_Task4b\\_20151027.pdf](http://www.alamedactc.org/files/managed/Document/17391/FR2_AlamedaCTC_GoodsMvmt_DvlpStrtgs_Task4b_20151027.pdf)

Cargomatic (2016, February 1) Cargomatic: Key Benefits. Retrieved from <https://www.cargomatic.com/shippers/>



Cargomatic (2016, January 24) "Solutions at the Ports" Retrieved from <https://www.cargomatic.com/drayage/>

Cassidy, William. (2015). Technology seen as key to unlocking 'hidden' truck capacity for shippers. Journal of Commerce

CCJ Staff (2015, November 4) Midwest gets \$25 grant to help with "smart" truck parking system. CCJ.com. Retrieved from: <http://www.ccjdigital.com/midwest-gets-25m-grant-to-help-with-smart-truck-parking-system/>

Cisco Systems, Inc. (2004) Utah Department of Transportation Creates CommuterLink to Help Utah Residents "Know Before You Go", Cisco Systems. Retrieved from [http://www.cisco.com/c/dam/en\\_us/solutions/industries/docs/trans/utah\\_dept\\_transportation.pdf](http://www.cisco.com/c/dam/en_us/solutions/industries/docs/trans/utah_dept_transportation.pdf)

Cisco Systems, Inc. (2004) Utah Department of Transportation Creates CommuterLink to Help Utah Residents "Know Before You Go", Cisco Systems. Retrieved from [http://www.cisco.com/c/dam/en\\_us/solutions/industries/docs/trans/utah\\_dept\\_transportation.pdf](http://www.cisco.com/c/dam/en_us/solutions/industries/docs/trans/utah_dept_transportation.pdf)

Davies, P. (2009) Container Terminal Reservation Systems. 3rd Annual METRANS National Urban Freight Conference, Long Beach CA. Retrieved from <http://dtci.ca/wp-content/uploads/2011/10/Container-Reservation-Systems-Web.pdf>

Dibenedetto, B. (2009). Logistics Tacoma Tests Rail Tracking. Pacific Shipper

Dupin, C. (2015, October 17). Vancouver cuts truck wait times. American Shipper.

Dupin, C. (2015, September 3). Manila container terminal to implement truck appointment system. American Shipper. 9/3/15.

Federal Highway Administration. (n.d.) Southern California Regional Freight Study, FWHA. Retrieved from [http://www.ops.fhwa.dot.gov/freight/freight\\_analysis/reg\\_ind\\_studies/so\\_cal\\_study.htm](http://www.ops.fhwa.dot.gov/freight/freight_analysis/reg_ind_studies/so_cal_study.htm)

Federal Highway Administration. (n.d.) Southern California Regional Freight Study, FWHA. Retrieved from [http://www.ops.fhwa.dot.gov/freight/freight\\_analysis/reg\\_ind\\_studies/so\\_cal\\_study.htm](http://www.ops.fhwa.dot.gov/freight/freight_analysis/reg_ind_studies/so_cal_study.htm)

Fleet O. (2015, November 24) MyGeoTracking platform integrates with Aljex. Retrieved from <http://fleetowner.com/technology/mygeotracking-platform-integrates-aljex>

FourKites (2015). FourKites offers free load tracking to brokers, Fleet Owner

Freight Mobility Strategic Investment Board and Washington State Department of Transportation (2008). FREIGHT MOBILITY: Joint Report on Washington State Freight Highway and Rail Projects. Retrieved from <http://www.wsdot.wa.gov/NR/rdonlyres/0F2FF705-5927-45F3-B7CD-309291F57ABD/0/FreightMobilityJointReportweb.pdf>

Freight Mobility Strategic Investment Board and Washington State Department of Transportation (2008). FREIGHT MOBILITY: Joint Report on Washington State Freight Highway and Rail Projects. Retrieved from <http://www.wsdot.wa.gov/NR/rdonlyres/0F2FF705-5927-45F3-B7CD-309291F57ABD/0/FreightMobilityJointReportweb.pdf>

Giuliano, G., & O'Brien, T., (2007) Reducing port-related truck emissions: The terminal gate appointment system at the Ports of Los Angeles and Long Beach. *Transportation Research Part D: Transport and Environment* 12(7): 460-473.

Giuliano, G., O'Brien, T., Dell'aquila, P., & Hayden, S. (2008). Evaluation of the Terminal Gate Appointment System at the Los Angeles/Long Beach Ports. METRANS Transportation Center, Project 04-06. Final Report. University of Southern California.

Globalterminals.com (2014, June 11). TSI Terminal Systems Inc. and DP World (Canada) Inc. set daytime reservation fee to partially pay for night gate operations at Port Metro Vancouver Terminals. Global Container Terminals

Guan, Chang Qian, and Rongfang (Rachel) Liu. (2008). Modeling Marine Container Terminal Gate Congestion, Truck waiting cost, and optimization. *Transportation Research Board*, 1-15.

Hanson, M. (2014) Truck Access and Parking: Improved Parking Information and Reservations for Truckers. Research Notes – Program Steering Committee (PSC): Transportation Safety and Mobility. Retrieved from: [http://www.dot.ca.gov/hq/research/researchreports/current\\_research/TransportationSafety&Mobility/docs/1831\\_ResearchNotes.pdf](http://www.dot.ca.gov/hq/research/researchreports/current_research/TransportationSafety&Mobility/docs/1831_ResearchNotes.pdf)

Hauswirth, M., & Jazayeri, M. (1999). A component and communication model for push systems. In *Software Engineering—ESEC/FSE'99* (pp. 20-38). Springer Berlin Heidelberg.

Hauswirth, M., & Jazayeri, M. (1999). A component and communication model for push systems. In *Software Engineering—ESEC/FSE'99* (pp. 20-38). Springer Berlin Heidelberg.

Heaver, T. (2009). Co-ordination in multi-actor logistics operations: challenges at the port interface. A Paper for the Workshop on Integrating Maritime Transport in Value Chains, Montreal.

Huynh, N. (2009). Reducing Truck Turn Times at Marine Terminals with Appointment Scheduling. In *Proceedings of Transportation Research Board 09*, Washington.

Huynh, N. and Walton, C.M. (2008) Robust scheduling of truck arrivals at marine container terminals. *Journal of Transportation Engineering* 134(8): 347–353.

IBI Group (2014) State Route 11/Otay Mesa East Port of Entry ITS Predeployment Study, Bi-National Concept of Operations Version 3.0 San Diego, CA, San Diego Association of Governments.

JB Hunt. (2016, January 26) J.B. Hunt 360 Shipment Tracking. Retrieved from [http://www.jbhunt.com/transportation\\_management/track\\_shipments/](http://www.jbhunt.com/transportation_management/track_shipments/)

Jensen M., Fayez S. and DeSantis S. (2015). Los Angeles-Gateway Freight Advanced Traveler Information System – Demonstration Team Final Report. FHWA-JPO-14-197. Retrieved from [http://ntl.bts.gov/lib/54000/54800/54838/FHWA-JPO-14-197\\_la\\_dtfr.pdf](http://ntl.bts.gov/lib/54000/54800/54838/FHWA-JPO-14-197_la_dtfr.pdf)

Jensen M. et al., (2012). Freight Advanced Traveler Information System – Concept of Operations. FHWA-JPO-12-065. Retrieved from <http://ntl.bts.gov/lib/54000/54100/54104/12-065.pdf>

Kari, D., Wu. G., and Barth, M. (2014). Eco-Friendly Freight Signal Priority using connected vehicle technology: A multi-agent systems approach. *Proceedings of the 2014 IEEE Intelligent Vehicles Symposium Proceedings*, Dearborn, MI, June 8-11.

Kimley-Horn and Assoc., Inc. and Cambridge Systematics, Inc. (2009) Advanced Traveler Information System Study: Task 3 Findings, Prepared for Mid-Ohio Regional Planning Commission. Retrieved from [http://www.morpc.org/trans/Task\\_3\\_final\\_report.pdf](http://www.morpc.org/trans/Task_3_final_report.pdf)

Kimley-Horn and Assoc., Inc. and Cambridge Systematics, Inc. (2009) Advanced Traveler Information System Study: Task 3 Findings, Prepared for Mid-Ohio Regional Planning Commission. Retrieved from [http://www.morpc.org/trans/Task\\_3\\_final\\_report.pdf](http://www.morpc.org/trans/Task_3_final_report.pdf)

Macropoint.(2016, February 2) Automated Track & Trace for Shippers & Freight Brokers. Retrieved from <http://www.macropoint.com/>

Maria, B., Eleftherios, S., Afroditi, A. (2014). Evaluating strategies to improve access to marine container terminals and streamline gate operations. *Transport Research Arena 2014*, Paris.

Martin and Warner (2012). I-5 Smart Truck Parking in California: Public-Private-Academic Collaboration to Aid Truckers in Finding Safe, Legal, and Available Parking Through ITS Technology. Retrieved from: [http://tsrc.berkeley.edu/sites/default/files/TRB\\_Smart%20Truck%20Parking%20in%20California.pdf](http://tsrc.berkeley.edu/sites/default/files/TRB_Smart%20Truck%20Parking%20in%20California.pdf)

Miller and Morris (2015). HNTB Smart Truck Parking. Retrieved from: <http://www.itsheartland.org/2015mtg/Presentations/Session2.Miller.pdf>

Minnesota State Department of Transportation (1998) Minnesota State-wide Plan for Advance Traveler Information System, Minnesota DOT. Retrieved from [http://www.dot.state.mn.us/guidestar/1996\\_2000/statwide\\_atis/2871execsummd.pdf](http://www.dot.state.mn.us/guidestar/1996_2000/statwide_atis/2871execsummd.pdf)

Minnesota State Department of Transportation (1998) Minnesota State-wide Plan for Advance Traveler Information System, Minnesota DOT. Retrieved from [http://www.dot.state.mn.us/guidestar/1996\\_2000/statwide\\_atis/2871execsummd.pdf](http://www.dot.state.mn.us/guidestar/1996_2000/statwide_atis/2871execsummd.pdf)

Minnesota State Department of Transportation (n.d.) Advance Traveler Information System Report, Minnesota DOT. Retrieved from [http://www.dot.state.mn.us/guidestar/2001\\_2005/tripusa/atisreport.pdf](http://www.dot.state.mn.us/guidestar/2001_2005/tripusa/atisreport.pdf)

Minnesota State Department of Transportation (n.d.) Advance Traveler Information System Report, Minnesota DOT. Retrieved from [http://www.dot.state.mn.us/guidestar/2001\\_2005/tripusa/atisreport.pdf](http://www.dot.state.mn.us/guidestar/2001_2005/tripusa/atisreport.pdf)

Mongelluzzo, B. (2011, July 4). The PierPass Puzzle. Journal of Commerce.

Mongelluzzo, B. (2011, October 10). PierPass Gets Passing Grade. Journal of Commerce.

Mongelluzzo, B. (2014, July 29). Vancouver penalty system cutting truck turn times. Journal of Commerce.

Mongelluzzo, B. (2014, July 31). Appointment system helps APL clear LA terminal congestion. Journal of Commerce.

Mongelluzzo, B. (2015, August 27). LALB terminals move toward truck appointments. Journal of Commerce.

Mongelluzzo, B. (2015). Tacoma uses on-dock rail as a competitive advantage. Journal of Commerce

Mongelluzzo, B. (2015, September 1). LALB truckers fear appointment systems won't reduce congestion enough. Journal of Commerce.

Mongelluzzo, B. (2016) Port of LA: 'Flawless' handling of largest mega-ship to call US shows effort paying off. Journal of Commerce

Morais, P. and Lord, E. (2006). Terminal Appointment System Study. Transport Canada. Retrieved from <https://www.tc.gc.ca/media/documents/policy/14570e.pdf>

Namboothiri, R. & Erera, A.L. (2008). Planning local container drayage operations given a port access appointment system. Transportation Research Part E, 44, 185-202

Namboothiri, R. & Erera, A.L. (2008). Planning local container drayage operations given a port access appointment system. *Transportation Research Part E*, 44, 185-202.

Newton D. et al. (2015). Dallas-Fort Worth Freight Advanced Traveler Information System – Demonstration Team Final Report. FHWA-JPO-15-220. Retrieved from [http://ntl.bts.gov/lib/55000/55300/55302/fratis\\_dfw\\_final\\_6\\_23\\_15.pdf](http://ntl.bts.gov/lib/55000/55300/55302/fratis_dfw_final_6_23_15.pdf)

O’Connell J. (2014, September 8) Smart Truck Parking Moves toward National Deployment. PRWeb.com. Retrieved from: <http://www.prweb.com/releases/2014/09/prweb12151321.htm>

Perry E, Oberhart, E and Wagner, S. (2015) Truck Parking Management Systems: A Synthesis of Projects, Research, and Resources for MAASTO Decision Makers (2015). Mid-America Freight Coalition. Retrieved from: [http://midamericafreight.org/wp-content/uploads/MAFC\\_TPMS\\_Synthesis\\_07012015.pdf](http://midamericafreight.org/wp-content/uploads/MAFC_TPMS_Synthesis_07012015.pdf)

Ranaiefar F. (2012) Intelligent Freight Transportation Systems. Institute of Transportation Studies. Retrieved from [http://freight.its.uci.edu/sites/default/files/cee298\\_presentations/rfatemeh/Intelligent%20Freight%20Transportation%20Systems\\_Fatemeh.pdf](http://freight.its.uci.edu/sites/default/files/cee298_presentations/rfatemeh/Intelligent%20Freight%20Transportation%20Systems_Fatemeh.pdf)

Ranaiefar F. (2012) Intelligent Freight Transportation Systems. Institute of Transportation Studies. Retrieved from [http://freight.its.uci.edu/sites/default/files/cee298\\_presentations/rfatemeh/Intelligent%20Freight%20Transportation%20Systems\\_Fatemeh.pdf](http://freight.its.uci.edu/sites/default/files/cee298_presentations/rfatemeh/Intelligent%20Freight%20Transportation%20Systems_Fatemeh.pdf)

Scora, G., Boriboonsomsin, K., and Barth, M. (2013). Eco-friendly navigation system development for heavy-duty trucks. Proceedings of the 92nd Annual Meeting of the Transportation Research Board, Washington, DC, January 13-17.

Scora, G. Boriboonsomsin, K., and Barth, M. (2015). Value of eco-friendly route choice for heavy-duty trucks. *Research in Transportation Economics*, 52, 3-14.

Seideman, T. (1989). EDI May Help End Truck Driver Shortage, *Journal of Commerce*

Sells J. (2015) California Sustainable Freight Action Plan: Pilot Project Idea – Reduced Emissions through Efficient Parking for Trucks. California Air Resources Board. Retrieved from: <http://www.arb.ca.gov/gmp/sfti/sfpp/sfpp-020.pdf>

Troup, K. (2014). FRATIS Assessment Update. CDM Smith Assessment Team, North River Consulting Group, and Booz Allen Hamilton. Retrieved from [http://www.fhwa.dot.gov/planning/freight\\_planning/talking\\_freight/july\\_2014/talkingfreight07\\_16\\_14kt.pdf](http://www.fhwa.dot.gov/planning/freight_planning/talking_freight/july_2014/talkingfreight07_16_14kt.pdf)

USDOT (2002). Implementation costs for transit signal priority range from \$8,000 to \$35,000 per intersection. U.S. Department of Transportation, <http://www.itscosts.its.dot.gov/its/benecost.nsf/ID/478B21EDD18C9EAE85256DB100458929?OpenDocument&Query=CApp>.

USDOT (2014a). Estimated annual DSRC site operations, maintenance and replacement costs range from \$1950 - \$3050. U.S. Department of Transportation, <http://www.itscosts.its.dot.gov/ITS/benecost.nsf/SummID/SC2014-00329?OpenDocument&Query=Home>.

USDOT (2014b). Preliminary Eco-Traffic Signal Priority (for transit and freight) and Connected Eco-Driving modeling results. U.S. Department of Transportation, [http://www.its.dot.gov/aeris/pdf/Eco-TrafficSignalPriority\\_ConnectedEco-Driving.pdf](http://www.its.dot.gov/aeris/pdf/Eco-TrafficSignalPriority_ConnectedEco-Driving.pdf).

USDOT (2014c). Total potential connected vehicle DSRC deployment costs at signalized intersections needing controller upgrades may cost on average \$51,600 per site. U.S. Department of Transportation, <http://www.itscosts.its.dot.gov/ITS/benecost.nsf/SummID/SC2014-00328?OpenDocument&Query=Home>.

USDOT (2014d). Unit Costs for DSRC-based Data Collection Equipment costs can range from \$4150 - \$9200. U.S. Department of Transportation, <http://www.itscosts.its.dot.gov/ITS/benecost.nsf/SummID/SC2014-00330?OpenDocument&Query=Home>.

Washington State Department of Transportation (2013, October). WSDOT Newsletter. Retrieved from <http://www.wsdot.wa.gov/NR/rdonlyres/3A730638-51AE-4284-B494-2229C618F8FD/0/FreightSystemsDivision.pdf>

Washington State Department of Transportation (2013, October). WSDOT Newsletter. Retrieved from <http://www.wsdot.wa.gov/NR/rdonlyres/3A730638-51AE-4284-B494-2229C618F8FD/0/FreightSystemsDivision.pdf>

Washington State Department of Transportation. (n.d.) 2007-2026 Highway System Plan, WSDOT. Retrieved from [http://www.wsdot.wa.gov/NR/rdonlyres/E799F5C8-4621-4353-8CE0-B71FAF4C7385/0/HSPChapter\\_EconomicVitality.pdf](http://www.wsdot.wa.gov/NR/rdonlyres/E799F5C8-4621-4353-8CE0-B71FAF4C7385/0/HSPChapter_EconomicVitality.pdf)

Washington State Department of Transportation. (n.d.) 2007-2026 Highway System Plan, WSDOT. Retrieved from [http://www.wsdot.wa.gov/NR/rdonlyres/E799F5C8-4621-4353-8CE0-B71FAF4C7385/0/HSPChapter\\_EconomicVitality.pdf](http://www.wsdot.wa.gov/NR/rdonlyres/E799F5C8-4621-4353-8CE0-B71FAF4C7385/0/HSPChapter_EconomicVitality.pdf)

Williamson M. et al. (2015). South Florida Freight Advanced Traveler Information System – Demonstration Team Final Report. FHWA-JPO-15-216. Retrieved from [http://ntl.bts.gov/lib/55000/55200/55223/sf\\_dtfr.pdf](http://ntl.bts.gov/lib/55000/55200/55223/sf_dtfr.pdf)

Yelchuru, B., Fitzgerald, S., Murari, S., Barth, M., Waller, T., Dixit, V., Wu, G., Xia, H., Singuluri, S., Duell, M., Boriboonsomsin, K., He, S., Wijayaratna, K., and Mao, T. (2014). AERIS: Applications for the Environment and Real-Time Information Synthesis - Eco-Signal Operations operational scenario modeling report. Report No. FHWA-JPO-14-185, December, 267 pp.

Zhao, W. and Goodchild, A. (2013). Using the truck appointment system to improve yard efficiency in container terminals. *Maritime Economics & Logistics*, 15, 101-119.

## Appendix

From the presentation “Smart Truck Parking – Improving the Parking Experience” (Caltrans, University of California, Berkeley, Parking Carma and NAVTEQ, 2011)

### PRECEDENTS IN CALIFORNIA (As of 2011)

#### Goal – to provide truckers with:

- Truck stop attributes.
- Real-time information of parking availability.
- Capability to make advanced parking reservations.

#### The Team:

- **UC Berkeley TSRC** will provide data collection for evaluation (including focus groups, surveys, and outreach) and the evaluation of the system performance. TSRC will research and highlight the energy and environmental benefits of the project.
- **NAVTEQ** will maintain a database of public and private truck parking with features of importance to truckers.
- **ParkingCarma** will integrate real-time truck parking availability & reservation capabilities with NAVTEQ’s customized truck parking mapping & routing services. The company will also customize an interface for truck drivers to access truck parking information as well as directions to parking facilities by VOICE (511 or 800 number), internet (PC or mobile devices), and possibly satellite radio.
- **Caltrans** will provide overall project management and coordination, grant access to public roads and public parking facilities, and provide recruiting support for public outreach.

#### Two Precedents:

Logistics Terminal, Lathrop CA (sensor testing)

- A drop and hook depot for trucks to deposit and pick up trailers.
- Has spare parking capacity usable by trucks, but is currently not known as an overnight truck parking facility.
- An ideal environment for testing sensor performance for having a single secure gate used for bot entrances and exits.

Flying J (Pilot), Lodi, CA

- Private truck stop with two entrances and 187 spaces that frequently fills up at night.
- Multiple sensing systems would be used and evaluated side-by-side.