

ADA Notice

For individuals with sensory disabilities, this document is available in alternate formats. For information call (916) 654-6410 or TDD (916) 654-3880 or write Records and Forms Management, 1120 N Street, MS-89, Sacramento, CA 95814.

1. REPORT NUMBER CA08-0564	2. GOVERNMENT ASSOCIATION NUMBER	3. RECIPIENT'S CATALOG NUMBER
4. TITLE AND SUBTITLE Airport Managers' Guide for the Maintenance of Asphalt Pavements of General Aviation Airports		5. REPORT DATE January 2009
7. AUTHOR Thomas L. Moses, J. Leroy Hulsey and Billy Connor	8. PERFORMING ORGANIZATION REPORT NO. INE/AUTC08.19	
9. PERFORMING ORGANIZATION NAME AND ADDRESS Transportation Center University of Alaska, Fairbanks 245 Duckering Fairbanks, AK 88775	10. WORK UNIT NUMBER 11. CONTRACT OR GRANT NUMBER 65A0173	
12. SPONSORING AGENCY AND ADDRESS California Department of Transportation Division of Research and Innovation, MS-83 1227 O Street Sacramento CA 95814	13. TYPE OF REPORT AND PERIOD COVERED 14. SPONSORING AGENCY CODE	
15. SUPPLEMENTARY NOTES		

16. ABSTRACT
 Hot asphalt pavement (HAP) is used as a surface material on many General Aviation (GA) airports in California. Currently there are 251 public use airports in California. An understanding of the proper design, construction and maintenance of the hot mix asphalt is critical to achieve optimum long-term performance. This guide provides the basics of pavement design, construction and maintenance. It is written for General Aviation Airport Managers with limited experience in asphalt pavements. Key topics include: 1) pavement distress; 2) maintenance strategies; 3) asphalt pavement construction; 4) pavement design and 5) asphalt mix design.

17. KEY WORDS Airport, asphalt, pavement, maintenance	18. DISTRIBUTION STATEMENT No restrictions. This document is available to the public through the National Technical Information Service, Springfield, VA 22161	
19. SECURITY CLASSIFICATION (of this report) Unclassified	20. NUMBER OF PAGES 81	21. COST OF REPORT CHARGED

DISCLAIMER STATEMENT

This document is disseminated in the interest of information exchange. The contents of this report reflect the views of the authors who are responsible for the facts and accuracy of the data presented herein. The contents do not necessarily reflect the official views or policies of the State of California or the Federal Highway Administration. This publication does not constitute a standard, specification or regulation. This report does not constitute an endorsement by the Department of any product described herein.

For individuals with sensory disabilities, this document is available in Braille, large print, audiocassette, or compact disk. To obtain a copy of this document in one of these alternate formats, please contact: the Division of Research and Innovation, MS-83, California Department of Transportation, P.O. Box 942873, Sacramento, CA 94273-0001.

**Airport Manager's Guide for the Maintenance of Asphalt Pavements of
General Aviation Airports**

Prepared by

Thomas L. Moses, P. E.
J. Leroy Hulseley, PhD., P.E.
Billy Connor, P.E.

Alaska University Transportation Center

For

State of California
Department of Transportation
Sacramento, California, 95814

January 2009

Final Report
Report No. INE/AUTC08.19
STATE OF CALIFORNIA DEPARTMENT OF TRANSPORTATION Report
Number CA08-0564

University of Alaska - Fairbanks
Fairbanks, Alaska, 99775-5900

Acknowledgements

The contents of this report reflect the views of the authors who are responsible for the facts and accuracy of the data presented herein. The contents do not necessarily reflect the official views or policies of the State of California or the Federal Highway Administration. This report does not constitute a standard, specification, or regulation.

This work was funded by the State of California Transportation Department of Transportation (CALTRANS).

Background

Initially this project was funded by CALTRANS to conduct a field investigation of representative General Aviation asphalt runway pavements. This was to be followed by a laboratory investigation and the results were to be reported from that study. The project name of that study (CALTRANS research task #0564, contract 65A0173) was CGAR Durability of Asphalt Pavement in General Aviation Airports in California under Different Weather and Traffic Conditions. As the project progressed both the CALTRANS managers and researchers realized that the needs of CALTRANS could be better met by modifying the scope.

The revised study better meets CALTRANS needs and was agreed upon by those who reviewed and were responsible for recommending funding. This project began approximately a year after the initial funding. The new work was conducted under the initial funding contract with a no-cost time extension.

TABLE OF CONTENTS

Chapter 1 INTRODUCTION	4
Chapter 2 PAVEMENT DISTRESS	5
2.1 General	5
2.2 Cracking	5
2.3 Disintegration	15
2.4 Distortion.....	17
2.5 Loss of Skid Resistance.....	20
2.6 Other Sources of Information.....	21
Chapter 3 MAINTENANCE	23
3.1 Pavement Preservation	23
3.2 Repair Methods	25
Chapter 4 CONSTRUCTION	30
4.1 Surface Preparation	30
4.2 Plant Operations	32
4.3 Asphalt Mix Transportation	35
4.4 Asphalt Mix Placement	35
4.5 Compaction	36
4.6 Construction Problems	39
4.7 Summary.....	41
Appendix A PAVEMENT DESIGN.....	42
A.1 General	42
A.2 Asphalt Pavement Structure	44
A.3 Pavement Design Parameters	45
A.4 Pavement Design Procedures	50
Appendix B APHALT MIX DESIGN	52
B.1 Asphalt Mix Types	52
B.2 Aggregate	52
B.3 Asphalt Binder.....	56
B.4 Asphalt Mix Design	60
Appendix C SUMMARY OF FAA ADVISORY CIRCULARS.....	66
Appendix D DEFINITIONS	70
Appendix E PAVEMENT CONDITION SURVEY	78

LIST OF FIGURES AND TABLES

Figure 2-1. Longitudinal cracks along paving joint.....	6
Figure 2-2. Longitudinal cracks along paving joints.	7
Figure 2-3. Longitudinal crack along paving joint and reflective crack.....	8
Figure 2-4. Wheel path crack.....	9
Figure 2-5. Transverse cracks.	10
Figure 2-6. Block cracking.	11
Figure 2-7. Reflection transverse cracking.	12
Figure 2-8. Reflective cracking.	12
Figure 2-9. Beginning stages of alligator cracking.....	13
Figure 2-10. Alligator cracking.	14
Figure 2-11. Alligator cracking and block cracking.	14
Figure 2-12. Slippage cracks.	15
Figure 2-13. Raveling. (<i>PASER Manual for Asphalt Airfield Pavements</i>).....	16
Figure 2-14. Potholes. (<i>PASER Manual for Asphalt Airfield Pavements</i>).....	17
Figure 2-15. Patched depressed area.....	19
Figure 2-16. Depressed area caused by aircraft parking on HMA before it cooled.	19
Figure 3-1. Comparison of traditional pavement rehabilitation	24
Table 3-1. Summary of sealant/filler specifications, cost and performance life.	26
Figure 3-2. Schematic of Slurry Surfacing Machine.	27
Figure 4-1. Large milling machine.	32
Figure 4-2. Asphalt Batch Plant. (AC 150/5370-14A).....	33
Figure 4-3. Asphalt Drum Mix Plant. (AC 150/5370-14A)	34
Figure A-1. Transfer of Wheel Load to Subgrade in concrete pavements.	43
Figure A-2. Distribution of Wheel Loads in Asphalt Pavements.	43
Figure A-3. CBR test.	47
Figure A-4. Formation of ice lenses in a pavement structure.	48
Figure A-5. Typical deflections illustrating seasonal pavement strength changes.....	49
Table A-1. Summary of pavement structural layers. (AC 150/5320-6D)	51
Figure B-1. Gradation chart of fine graded asphalt mix and maximum density line.	54
Figure B-2. Asphalt binders recommended by CALTRANS.	60
Figure B-3. Schematic of stability-durability relationship of hot mix asphalt.	61
Table B-1. Summary of Marshall Mix Design Criteria	63

Chapter 1

INTRODUCTION

Hot asphalt pavement (HAP) is used as a surface material on many General Aviation (GA) airports in California. Currently there are 251 public use airports in California. An understanding of the proper design, construction and maintenance of the hot mix asphalt is critical to achieve optimum long-term performance.

This guide provides the basics of pavement design, construction and maintenance. It is written for General Aviation Airport Managers with limited experience in asphalt pavements. Key topics include: 1) pavement distress; 2) maintenance strategies; 3) asphalt pavement construction; 4) pavement design and 5) asphalt mix design.

This guide is not intended to be a comprehensive report describing all aspects of asphalt pavements but it is intended to provide a brief summary of the key topics necessary to understand asphalt pavements with references to other sources for more in-depth information.

Chapter 2

PAVEMENT DISTRESS

2.1 General

There are numerous forms of pavement distress with different causes for failure. Understanding the type of pavement failure is essential in selecting the appropriate type of pavement rehabilitation or pavement preservation.

Trained personnel should perform a detailed inspection of airfield pavements at least once a year. If a history of recorded pavement deterioration in the form of a Pavement Condition Index (PCI) survey as set forth in ASTM D 5340, *Standard Test Method for Airport Pavement Condition Index Surveys*, is available, the frequency of inspections may be extended to 3 years.

In addition, a drive-by inspection should occur at least once per month to detect unexpected changes in the pavement condition.

The primary types of pavement distress in asphalt pavements include: 1) cracking, 2) disintegration, 3) distortion, and 4) loss of skid resistance.

2.2 Cracking

There are a number of different causes of cracks in asphalt pavements. Cracks usually start as very thin cracks that widen and erode with age. If the cracks are not sealed in a timely fashion, they can ravel and develop into multiple cracks which will require more extensive repair and may produce foreign object debris (FOD).

There are basically six different types of cracks in asphalt pavements: longitudinal, transverse (thermal), reflective, block, alligator (fatigue) and slippage cracks. Some will expand and contract with changes in temperature; cracks that expand at least ¼ inch wide (FHWA criteria is 1/8" wide) during a year are considered "working cracks." Cracks with less movement are considered "nonworking cracks."

2.2.1 Longitudinal Cracks - Longitudinal cracks are straight cracks parallel to centerline or the direction of paving. These cracks are generally caused by either:

- Poorly constructed paving joints due to inadequate bonding between the paving panels and poor compaction during construction. (Figures 2-1 & 2-2)
- Reflection of longitudinal cracks or joints in the underlying asphalt/concrete pavement surface that reflects through the top pavement layer. (Figure 2-3)
- Reflection cracks can also occur at the contact zone where the runway has been widened.

- Wheelpath cracking is a load induced crack in the wheel paths which evolves into alligator cracking. (Figure 2-4)

Longitudinal cracks that are 1/4" to 3/4" wide should be filled to: 1) prevent water from penetrating into the base course, 2) prevent filling the cracks with incompressible material (which prevents contraction during the summer), 3) prevent further degradation of the crack, and 4) extend the pavement life.

Longitudinal cracks can also occur in conjunction with transverse cracks as thermal cracks. If the spacing between the transverse cracks is less than the width of the pavement, longitudinal cracks can develop due to the shrinkage (contraction) of the asphalt surface. This pavement contraction is due to low temperatures or hardening of the asphalt binder. These cracks are considered "working" cracks that shrink during the summer and expand in the winter.

Longitudinal cracks associated with transverse cracks should be routed to create a 1/2" by 1/2" reservoir for the elastomeric sealant. These cracks should be sealed spring or fall when the cracks are still relatively wide. This will allow the crack to remain sealed as it expands in the winter and contracts during the summer. Periodic slurry seals or surface treatments will slow the age hardening of the asphalt binder and retard the development of the thermal cracks.

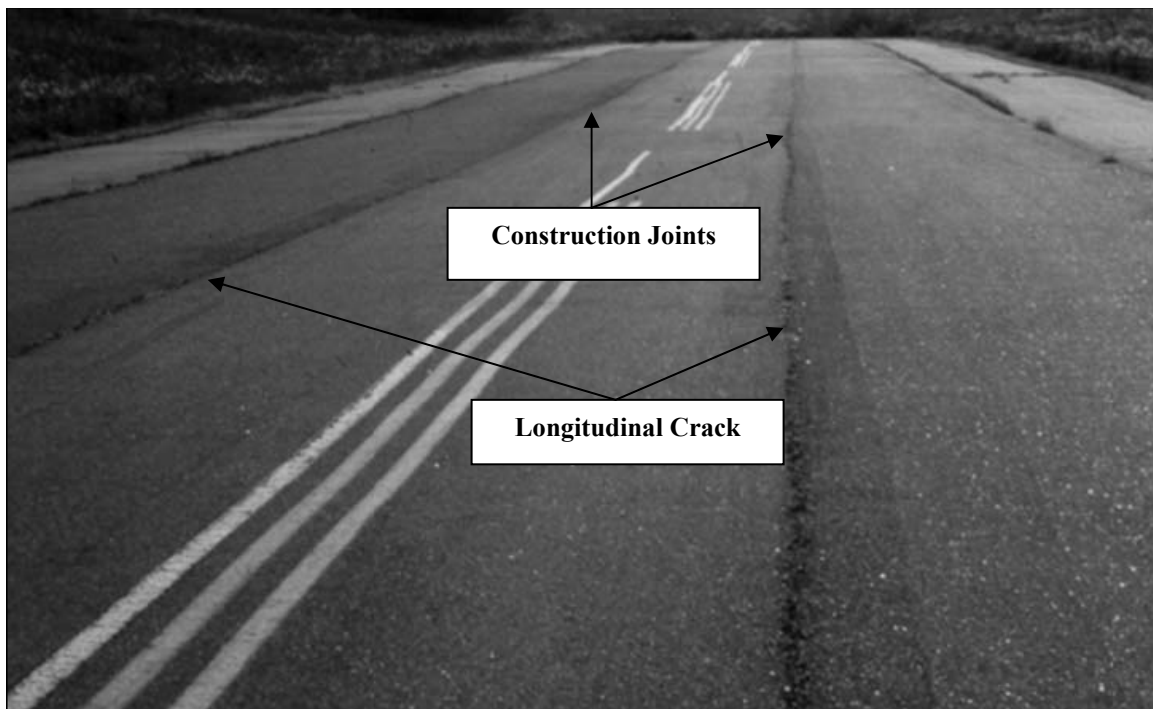

Figure 2-1. Longitudinal cracks along paving joint.
(PASER Manual for Asphalt Airfield Pavements)

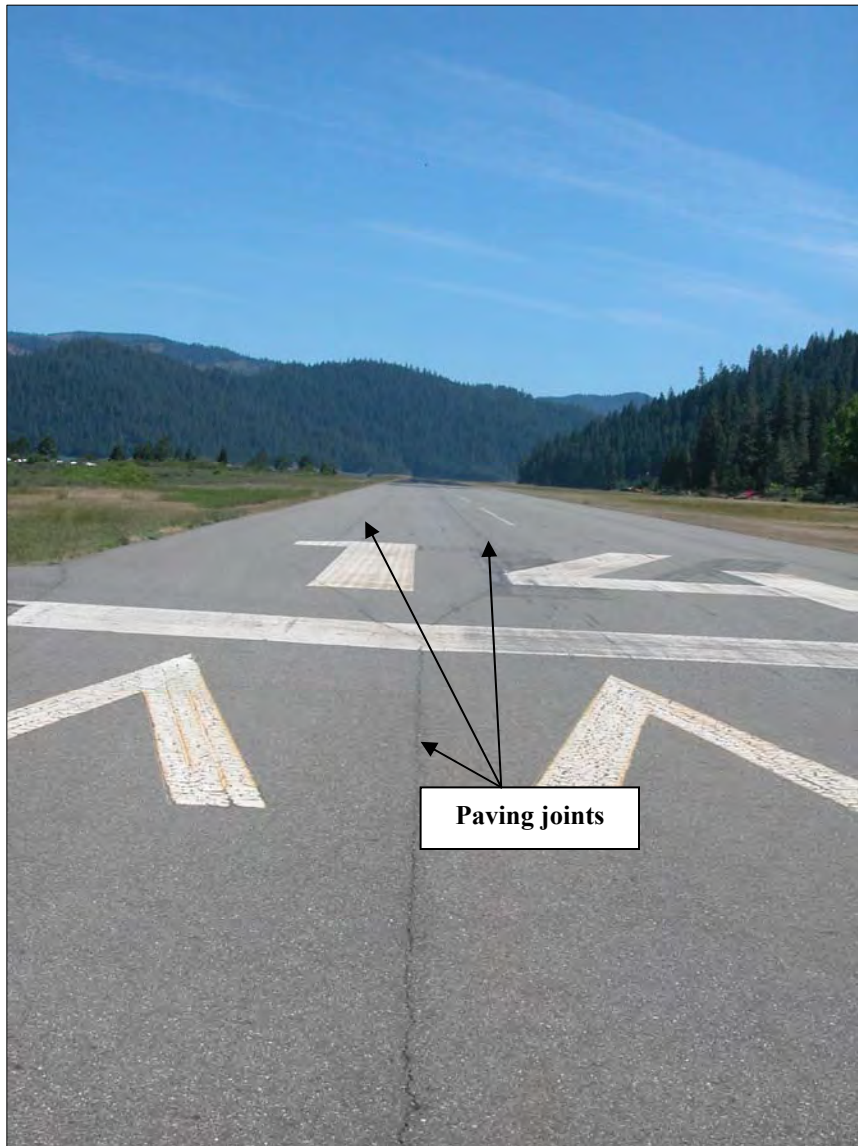

Figure 2-2. Longitudinal cracks along paving joints.
(Trinity Center Airport)

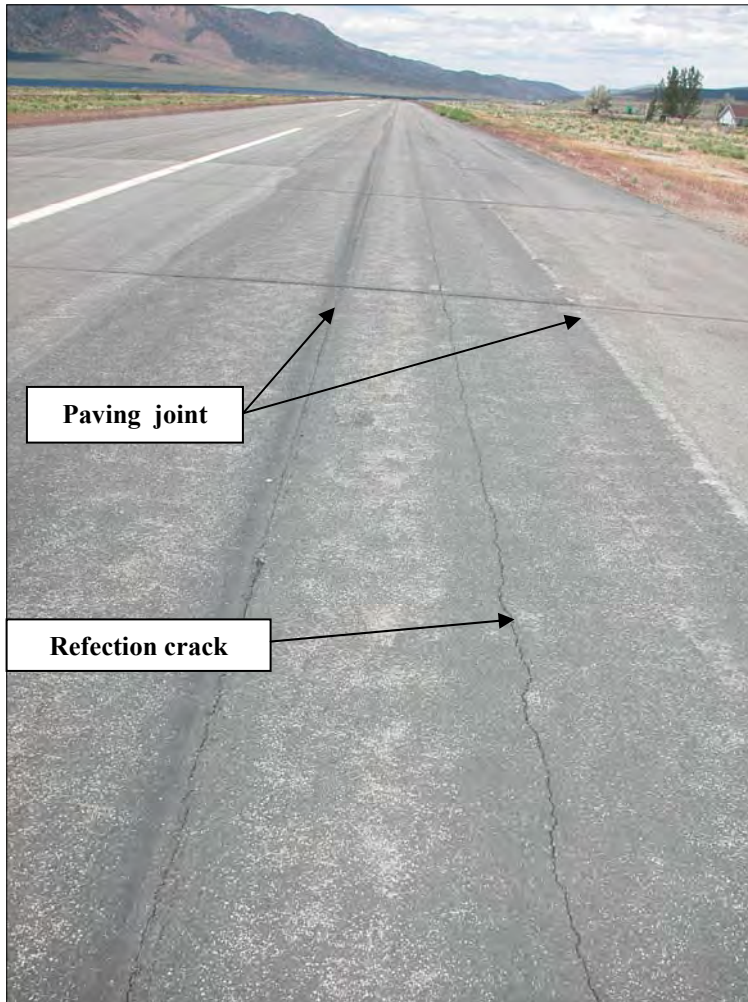

Figure 2-3. Longitudinal crack along paving joint and reflective crack.
(*Bryant Field*)

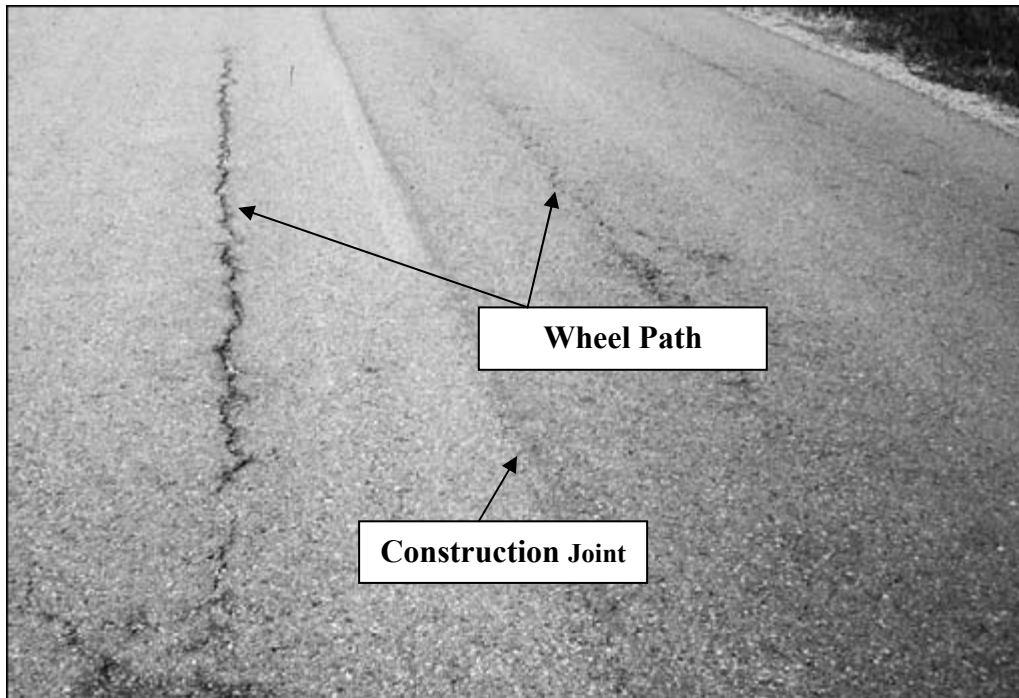

Figure 2-4. Wheel path crack.
(*PASER Manual for Asphalt Airfield Pavements*)

2.2.2 Transverse Cracks - Transverse cracks are relatively straight cracks that extend across the pavement at approximately right angles to the pavement centerline. Transverse cracks are either thermal cracks (Fig. 2-5) or reflection cracks from the underlying pavement. (Fig. 2-6)

The thermal cracks are caused by contraction of the asphalt pavement due to cold temperatures and not by aircraft loading or traffic (Fig. 2-5). The primary factors affecting thermal cracks are the asphalt binder grade, age of the asphalt pavement and pavement temperature.

Transverse cracks generally develop 2 to 7 years after construction. They initially occur at long (100' to 200') consistent spacing intervals. As the pavement ages, it oxidizes and hardens, which changes the thermal contraction properties of the asphalt. Further, as the pavement ages, the spacing between the transverse cracks decreases. For example, the transverse cracks may initially develop at two hundred foot intervals. As the pavement ages, additional transverse cracks will develop at half (100') the spacing of the initial transverse cracks. As the pavement continues to age, transverse cracks will continue to develop at half (50', 25', etc.) the spacing of the previous transverse cracks. If the spacing is 10' or less, the cracks are considered block cracking.

Transverse cracks are considered “working” cracks that shrink during the summer and expand in the winter. Transverse cracks should be routed to create a 1/2” by 1/2” reservoir for the elastomeric sealant. These cracks should be sealed in the spring or fall,

when the cracks are still relatively wide. This will allow the crack to remain sealed as it expands in the winter and contracts during the summer. Periodic slurry seals or surface treatments will slow the age hardening of the asphalt binder and retard development of thermal cracks.

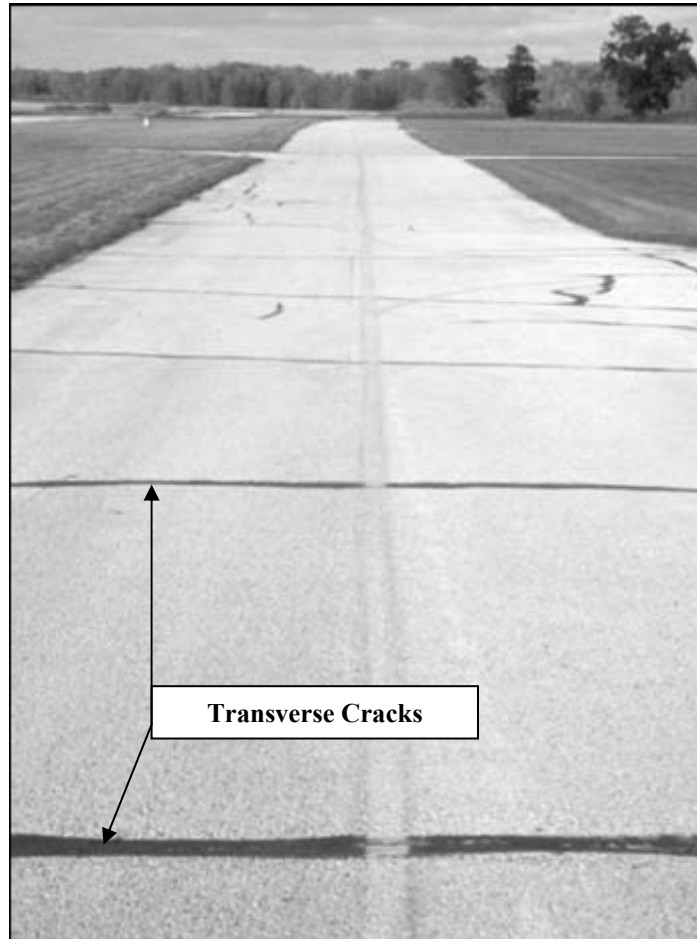

Figure 2-5. Transverse cracks.
(*PASER Manual for Asphalt Airfield Pavements*)

2.2.3 Block Cracking - Block cracks are interconnected cracks that divide the pavement into approximately rectangular pieces. The blocks may range in size from approximately 1 ft. by 1 ft. to 10 ft. by 10 ft. If the crack spacing is larger than 10 feet, it is normally classified as longitudinal and transverse cracks. Block cracking is not traffic or load related and normally occurs over a large portion of the runway/apron in non-traffic areas.

Block cracking is caused primarily by contraction of the asphalt during cold weather. The occurrence of block cracking usually indicates that the asphalt has hardened with age. This type of distress differs from alligator cracking in that the alligator cracks form smaller, many-sided irregular pieces with sharp angles.

Cracks that are 1/4" to 3/4" wide should be sealed similar to longitudinal cracks.



Figure 2-6. Block cracking.
(*PASER Manual for Asphalt Airfield Pavements*)

2.2.4 Reflection Cracking - Reflection cracks are caused by cracks or other discontinuities in an underlying pavement surface that propagates up through the overlying pavement. These cracks reflect the crack pattern of the underlying pavement and are caused by movement of the underlying pavement due to expansion and contraction caused by temperature and moisture changes. Reflection cracks occur most frequently in asphalt pavement overlays on top of jointed concrete pavements or on top of asphalt pavement that showed longitudinal transverse or block cracking.

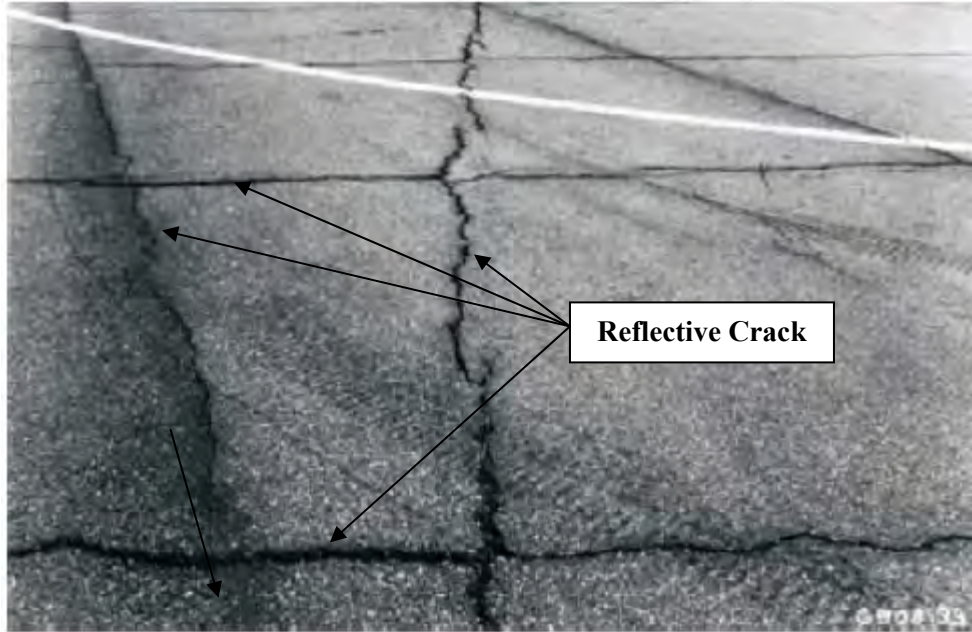

Figure 2-7. Reflection transverse cracking.
(Paver - Asphalt Surfaced Airfields)



Figure 2-8. Reflective cracking.
(Paver - Asphalt Surfaced Airfield)

2.2.5 Alligator (Fatigue) Cracking - Alligator or fatigue cracking is a series of interconnecting cracks caused by fatigue failure of the asphalt pavement surface under repeated traffic loading. It may also be caused by weak or saturated subbase or subgrade

courses. Alligator cracking occurs in wheel paths and other areas subjected to repeated aircraft loadings.

The cracking initiates at the bottom of the asphalt pavement surface where the tensile stress and strain are highest under a wheel load. The cracks propagate to the surface initially as a series of parallel cracks (wheel path cracking). After repeated traffic loading or by excessive deflection of the pavement surface over a weak foundation, the cracks connect, forming many-sided, sharp-angled pieces that develop a pattern resembling chicken wire or alligator skin. The pieces are less than 2 feet on the longest side.

Small areas of localized alligator cracking should be repaired by removing and replacing the asphalt pavement and subgrade. If a large area of the pavement has extensive alligator cracking, it should be overlaid with hot asphalt pavement. Since pavement with extensive alligator cracking has no structural value, the hot asphalt pavement overlay should be designed to support all of the anticipated loading. To prevent reflective cracking, the cracked pavement should either be removed or reconditioned by milling and blending with the underlying material.

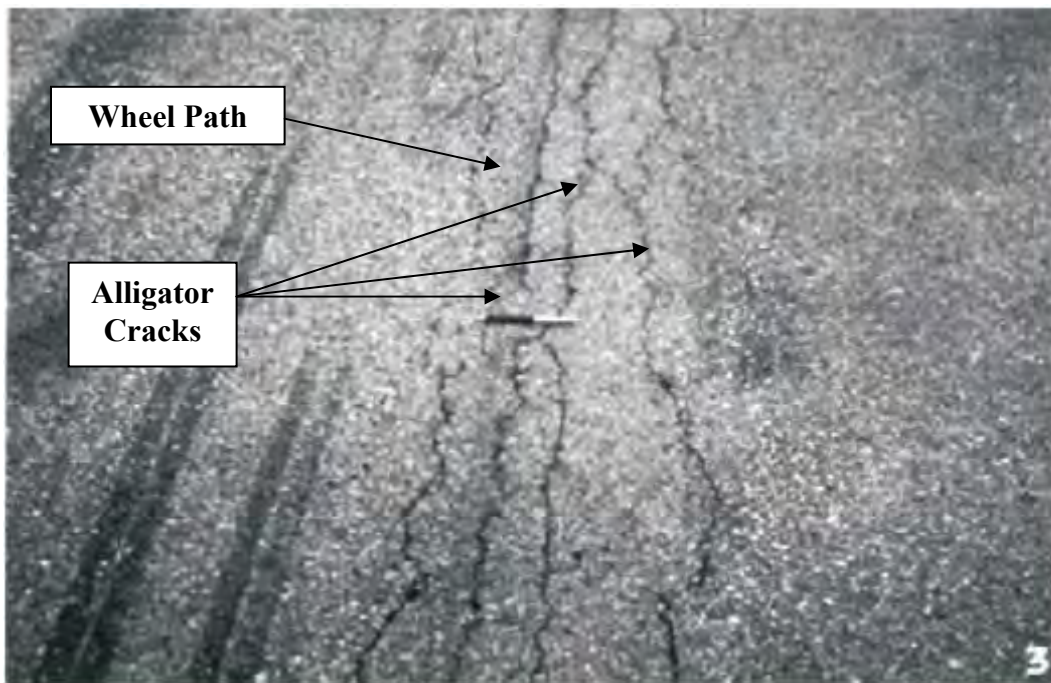

Figure 2-9. Beginning stages of alligator cracking.
(*PASER Manual for Asphalt Airfield Pavements*)



Figure 2-10. Alligator cracking.
(*PASER Manual for Asphalt Airfield Pavements*)

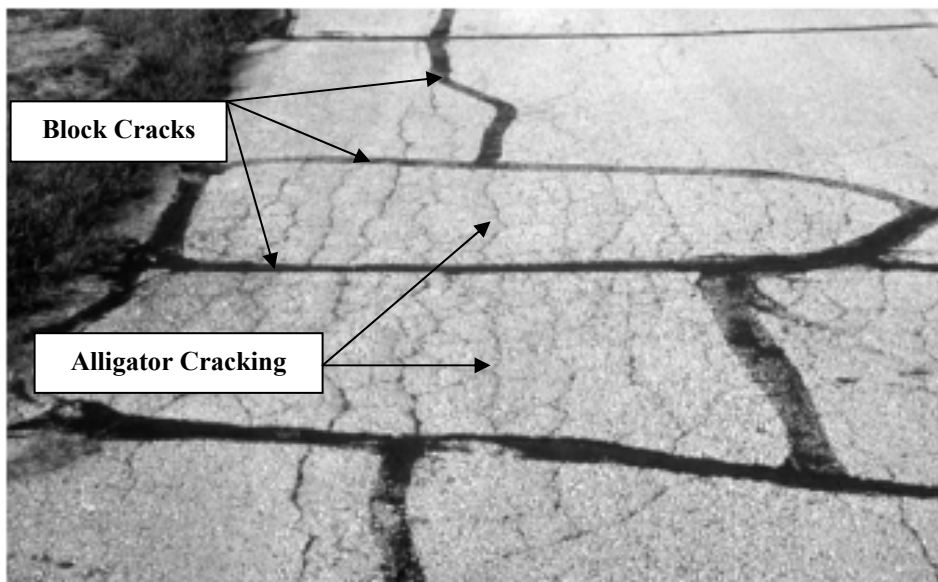

Figure 2-11. Alligator cracking and block cracking.
(*PASER Manual for Asphalt Airfield Pavements*)

2.2.6 Slippage Cracks - Slippage cracks are crescent-shaped cracks that appear when braking or turning wheels cause the pavement surface to slide and deform. This usually occurs when there is a low-strength surface mix or a poor bond between the surface and the next layer of the pavement structure. The crescent-shaped cracks have the ends pointing away from the direction of traffic.

Small areas of slippage cracks can be repaired by removing and replacing the asphalt pavement.



Figure 2-12. Slippage cracks.
(*PASER Manual for Asphalt Airfield Pavements*)

2.3 Disintegration

Disintegration is caused by: 1) insufficient compaction of the pavement; 2) insufficient asphalt binder in the mix; or 3) loss of adhesion between the asphalt coating and aggregate particles.

2.3.1 Raveling - Raveling is the progressive dislodgement of aggregate from the pavement surface. The primary causes of raveling are:

- Inadequate compaction during construction does not permit the development of sufficient cohesion of the asphalt pavement.
- Aggregate segregation causes concentration of coarse particles. In these areas, the fine particles are missing which reduces the contact area that binds the aggregate together.
- Dust coating on the coarse aggregate that forces the asphalt binder to adhere to the dust coating and not the aggregate.
- Aging of the asphalt binder reduces the adhesion between the binder aggregate particles.

Fog seals applied at the early stages of pavement deterioration will retard continued raveling for short periods of time.

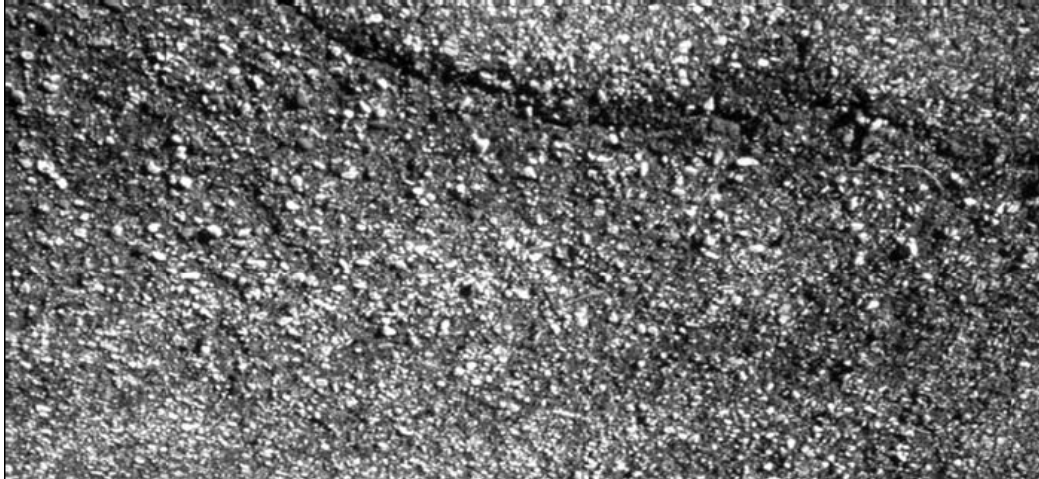

Figure 2-13. Raveling. (*PASER Manual for Asphalt Airfield Pavements*)

2.3.2 Potholes - A pothole is a small localized bowl-shaped depression of the pavement surface that extends the entire depth of the asphalt pavement. They generally have sharp edges and vertical sides near the top of the pot hole. Potholes often appear after rain or during thaw periods when pavements are weaker. Potholes are caused by:

- Raveling, stripping or cracking of the pavement surface.
- Fatigue cracking of the pavement results in interlocking pieces of pavement which are eventually worked loose by vehicle traffic.
- Freeze/thaw action may cause the base and subbase material to be saturated during thawing periods which reduces the strength of the pavement structure and results in cracking.

Potholes should be patched by removing the asphalt pavement and replacing with asphalt material. Potholes will continue to grow if not repaired. Potholes are not a common form of distress at airfields.



Figure 2-14. Potholes. (*PASER Manual for Asphalt Airfield Pavements*)

2.3.3 Asphalt Stripping - Asphalt stripping is the loss of bond between the asphalt binder and aggregate; it generally starts at the bottom of the pavement and progresses upwards.

Stripping is caused by poor chemical compatibility between the aggregate and asphalt binder. Stripping can be minimized or eliminated with the use of a proper anti-strip additive in the asphalt mix.

2.3.4 Jet Blast Erosion - Jet blast erosion is defined as a darkened area of pavement surface where the bituminous binder has been burned or carbonized. Localized burned areas may vary in depth up to approximately 1/2-inch (13 mm).

2.3.5 Patching and Utility Cut Patch - A patch is defined as an area where the original pavement has been removed and replaced by a filler material. A patch is considered a defect in the pavement, regardless of how well it is performing. Deterioration of patch areas affects the riding quality and may produce foreign object debris (FOD).

2.4 Distortion

Distortion in asphalt pavements is caused by foundation settlement, insufficient compaction of the pavement courses, instability in the bituminous mix, poor bond between the surface and the underlying layer of the pavement structure, and swelling soils or frost action in the subgrade. Five types of pavement distortion commonly occur on asphalt pavements:

2.4.1 Rutting - A rut is characterized by a surface depression in the wheel path. In many instances, ruts become noticeable only after a rainfall when the wheel paths fill with water. This type of distress is caused by a permanent deformation in any one of the pavement layers or subgrade, resulting from the consolidation or displacement of the materials due to traffic loads. Rutting does not normally occur on General Aviation airport pavements.

2.4.2 Corrugation - Corrugation results from a form of plastic surface movement typified by ripples across the surface. Corrugation can be caused by a lack of stability in the mix and a poor bond between material layers. Corrugation does not normally occur on General Aviation airport pavements.

2.4.3 Shoving - Shoving is the localized bulging of the asphalt pavement surface. It can be caused by lack of stability in the asphalt mix.

2.4.4 Depression - Depressions are localized low areas of limited size. In many instances, light depressions become noticeable only after a rain, when ponding creates "birdbath" areas. Depressions may result from localized settlement of the underlying pavement layers, poor construction methods or heavier-than-anticipated aircraft. Depressions may also be caused by not allowing newly laid pavement to cool before opening for traffic (Figures 2-14).



Figure 2-15. Patched depressed area.



Figure 2-16. Depressed area caused by aircraft parking on HMA before it cooled.

2.4.5 Swelling - An upward bulge in the pavement surface characterizes swelling. It may occur sharply over a small area or as a longer gradual wave. Both types of swelling may be accompanied by surface cracking. A swell is usually caused by frost action surrounding dissimilar material types in the subgrade or by swelling soil.

These sections should be repaired by removing and replacing the pavement and subgrade.

2.5 Loss of Skid Resistance

Hydroplaning and/or unacceptable loss of traction can result in poor braking performance and possible loss of directional control. Factors affecting the skid resistance of the pavement are aggregate size, resistance to polish & wear, aggregate texture, and aggregate shape. The larger aggregate provides a rougher pavement surface texture and better skid resistance. Friction loss can also be decreased due to rubber deposits, dust particles, fuel spillage, snow, ice and slush.

Techniques for improving skid resistance are grooving, porous friction course (PFC), chip seals and aggregate slurry seals. PFC should not be used on runway surfaces with high traffic due to accumulation of rubber. Chip seals provide temporary improvement in surface friction. Fog seal should be applied to the top of the chip seal to minimize loose chips and prevent aircraft damage. Aggregate slurry seals provide temporary (2 to 5 years) improvement in skid resistance but do not hold up well in cold climates where snow removal operations may damage the seal. To avoid loss of directional control the skid resistance properties of the painted surfaces must be similar to those of the unpainted pavement surfaces.

Friction surveys should be conducted to identify areas where water ponds during rain storms. If the average water depth exceeds 1/8 inch over a longitudinal distance of 500 feet, the pavement surface should be corrected.

Continuous friction measuring equipment (CFME) is used to measure the frictional values (Mu) of the pavement at airports used by turbojets. The frictional values are measured at two speeds. Friction values measured at 40 MPH determine the overall macro-texture/contaminant/drainage condition of the pavement surface. Friction values measured at 60 MPH determine the micro-texture of the pavement surface. The approved CFME are listed in Appendix 4 of AC 150/5320-12C; this table is updated periodically. At the time of this report, the last update was Change # 8 (dated 2/7/07). The Mu requirements are listed in Table 3-2 of AC 150/5320-12C.

If the Mu does not meet the criteria in Table 3 of AC 150/5320-12C, the pavement texture depth should be measured. The pavement texture depth (in inches) is measured by spreading a known volume of grease on the pavement surface. Texture depth is calculated as the volume of grease (cubic inch) divided by the area (sq. inch) covered by grease.

More information on skid resistance is available at AC 150/5320-12C and http://www.faa.gov/airports_airtraffic/airports/resources/advisory_circulars/media/150-5320-12C/150_5320_12c.PDF.

Factors that decrease the skid resistance of a pavement surface and can lead to hydroplaning include: 1) too much asphalt in the bituminous mix; 2) too heavy a tack coat; 3) poor aggregate subject to wear; and 4) buildup of contaminants. The skid resistance can be increased by applying a seal coat.

In asphalt pavements, a loss of skid resistance may result from the following:

2.5.1 Polished Aggregate. Polished aggregate is present when the portion of aggregate extending above the asphalt is either very small or poor quality such that there are no rough or angular particles to provide good skid resistance.

2.5.2 Contaminants. Accumulation of rubber particles, oils, or other external materials on the pavement surface will reduce the skid resistance of a pavement. Buildup of rubber deposits in pavement grooves will reduce the effectiveness of the grooves and increase the likelihood of hydroplaning.

2.5.3 Bleeding. Bleeding is characterized by a film of bituminous material on the pavement surface that resembles a shiny, glass-like, reflecting surface that usually becomes sticky in hot weather. It is caused by excessive amounts of asphalt binder in the mix and/or low air-void content; it occurs when asphalt binder fills the voids in the mix during hot weather and then expands out onto the surface of the pavement. Bleeding may also result when an excessive tack coat is applied prior to placement of the hot-mix asphalt (HMA) surface. Since the bleeding process is not reversible during cold weather, asphalt binder will accumulate on the surface. Extensive bleeding may severely reduce skid resistance.

2.5.4 Fuel/Oil Spillage. Continuous fuel/oil spillage on a HMA surface will soften the asphalt. Areas subject to only minor fuel/oil spillage will usually heal without repair, and only minor damage will result.

2.6 Other Sources of Information

Other sources of information of asphalt pavement distress are:

- ASTM D 5340, *Standard Test Method for Airport Pavement Condition Index Surveys*, provides detailed examples of each form of distress and presents the method for determining the Pavement Condition Index based on the type and severity of pavement distress.
- *PASER Manual for Asphalt Airfield Pavements* is a pavement surface evaluation and rating manual and is included in AC 150/5320-17 (http://www.faa.gov/airports_airtraffic/airports/resources/advisory_circulars/media/150-5320-17/150_5320_17_part2.pdf).

- *Paver Asphalt Surfaced Airfields Pavement Condition Index (PCI)*
(http://www.wbdg.org/ccb/DOD/UFC/ufc_3_270_06.pdf) from the Department of Defense Unified Facilities Guide includes examples of the various types of pavement distress.
- *Airfield Pavement Condition Survey Procedures Pavements*
(http://www.wbdg.org/ccb/DOD/UFC/ufc_3_260_16fa.pdf) from the Department of Defense Unified Facilities Guide also include examples of the various types of pavement distress.
- CALTRANS *Maintenance Technical Advisory Guide*
(http://www.dot.ca.gov/hq/maint/MTA_Guide.htm)
- Washington State DOT Pavement Guide
(http://training.ce.washington.edu/wsdot/modules/09_pavement_evaluation/09-7_body.htm)
- Washington Asphalt Pavement Association Asphalt Pavement Guide
(http://www.asphaltwa.com/wapa_web/modules/11_guidance/11_surface_distress.htm#block_cracking)

Chapter 3

MAINTENANCE

Deterioration of pavements due to traffic and adverse weather conditions cannot be prevented. Pavement distress such as cracks, potholes and depressions severely affects the structural integrity, ride quality, safety and serviceability of the airport pavement. Early detection and repair of pavement distress areas is the most important preventive maintenance procedure. Maintenance and repair programs can significantly reduce the rate of deterioration, minimize pavement damage and extend pavement life.

3.1 Pavement Preservation

Pavement Preservation is a proactive approach to preventative maintenance which extends the life of asphalt pavement and reduces the need for expensive and time-consuming pavement rehabilitation and reconstruction projects.

All asphalt pavements harden and become brittle as they age. This hardening is primarily due to changes in the chemical composition of the binder (oxidation), loss of dispersed gasses (volatilization) and other aging mechanisms. Hardening of an asphalt film takes place at different rates according to the amount of exposure to moisture and air. Temperature conditions in the pavement also affect the rate of hardening of the asphalt binder. Permeable pavements or pavements with high void contents with open surfaces age faster. Water infiltrating the pavement carries dissolved oxygen and trace elements that promote aging.

As the pavement ages, it becomes susceptible to thermal transverse cracking and eventually block cracking. The asphalt binder also experiences fatigue cracking due to cohesive binder failures under traffic loads. The asphalt pavement may also experience stone loss or raveling as it ages.

Pavement Preservation is the maintenance approach to treating and preserving the pavement before it shows significant signs of failure. This approach allows the advantage of minimizing user complaints and reduces the overall cost of the asphalt pavement. The Pavement Preservation approach uses a series of low-cost preventative maintenance techniques, each of which lasts only a few years, to extend pavement life. This translates into a more cost-effective use of limited funds. FHWA reports that the Pavement Preservation approach to maintenance could save from four to six dollars for pavement reconstruction costs for each dollar spent on preservation.

Figure 3-1 illustrates the differences between traditional pavement rehabilitation approaches and a proactive strategy of Pavement Preservation. The traditional approach of pavement maintenance allows the original pavement to deteriorate to fair to poor condition, at which point structural damage has occurred that triggers the need for expensive and time-consuming pavement rehabilitation. In contrast, a Pavement Preservation strategy, in

which relatively low-cost preventive maintenance treatments are triggered at more frequent intervals, results in a much greater interval between pavement rehabilitations.

Pavement preservation strategies are not well suited for pavements requiring major rehabilitation or reconstruction. Types of pavement preservation vary with pavement conditions, climatic, environmental, and other regional factors. No form of pavement preservation treatment can ward off pavement deterioration forever. However, the strategies and techniques of pavement preservation can significantly slow the deterioration rate.

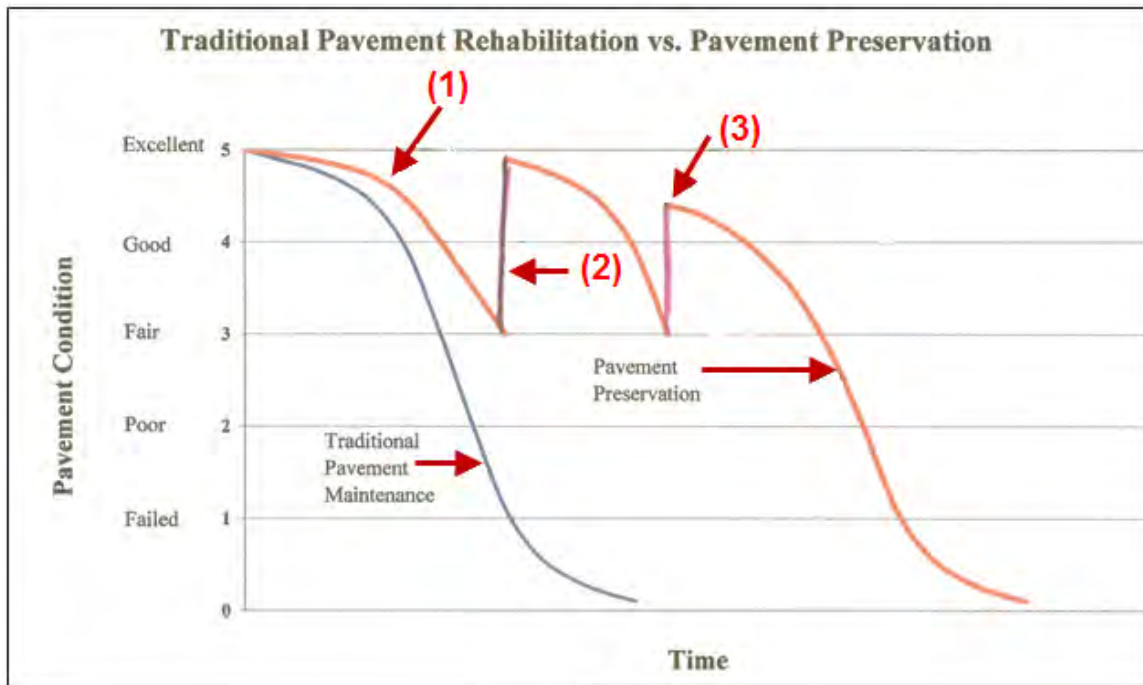

Figure 3-1. Comparison of traditional pavement rehabilitation and pavement preservation maintenance strategies.

To be effective, a pavement program must take a coordinated, budgeted, and systematic approach to both preventive and remedial maintenance. The first step in pavement maintenance is to determine the cause of the pavement distress. The Airport Manager can select a repair method that will not only correct the present damage, but also prevent or retard further pavement deterioration. Airports should perform repairs at early stages of distress. Failure to perform routine maintenance during these early stages will eventually result in more serious pavement problems and that could affect safe aircraft operations and require expensive repairs.

Weather conditions may limit repair measures undertaken to prevent further pavement damage. For example, rehabilitation by crack filling is more effective in cool and dry weather conditions, whereas pothole patches, seal coats, and other surface treatments

require warm, dry weather for best results. This does not mean that resurfacing work cannot be performed under cold and damp conditions or that crack filling cannot be done in warm weather. Rather, these repairs just require much greater care when made during such periods.

All maintenance activities must include quality control monitoring to assure that repairs are conducted properly and clean-up activities undertaken to remove this potential. The current version of AC 150/5380-5, *Debris Hazards at Civil Airports*, provides additional guidance to help eliminate debris hazards associated with maintenance activities.

3.2 Repair Methods

3.2.1 Crack Sealing and Crack Filling - Moisture entering the lower layers of the pavement structure will weaken the pavement structure and is the primary cause of pavement deterioration. An effective crack filling/sealing program will prolong pavement life by preventing moisture and incompressible material from filling the crack.

The FAA AC 150/5380-6B considers crack sealing and filling as the same procedure. This AC provides four guide specifications for crack filling:

- M-361, Hot–Applied Joint and Crack Sealants for Rigid (Portland Cement Concrete) and Flexible (Bituminous) Pavements.
- M-462, Cold-Applied Joint and Sealants for Flexible (Bituminous) Pavements.
- M-362, Silicone Joint and Crack Sealants for Rigid and Flexible (Bituminous) Pavements.
- M-461, Hot-Applied Crack Sealants/Fillers with Fibers for Flexible (Hot-Mix Asphalt) Pavement Overlays.

In contrast, CALTRAN’s *Maintenance Technical Advisory Guide (TAG)* considers crack sealing and crack filling as two different maintenance methods. The two methods vary in the amount of crack preparation and type of sealant. Crack sealing is more expensive and lasts longer than crack filling. Table 3-1 summarizes the various crack sealants and fillers with approximate costs and service lives.

Crack sealing is a localized treatment method that places specialized material in “working cracks” – primarily transverse cracks and longitudinal cracks that expand during the winter and contract during the summer. The key characteristics of the crack sealant material are: 1) adherence to the walls of the crack over a range of service temperatures and 2) ability to stretch during periods of crack contraction and recover to original condition without rupture. The cracks are either sawed or routed (which is not commonly done in California) to create a reservoir 1/2 to 3/4 inches wide and approximately 3/4” deep for the sealant.

Crack filling is also a localized treatment method that places specialized material in “nonworking cracks” – primarily block cracks and most longitudinal fissures. Crack filling involves less crack preparation and less expensive sealant material.

Table 3-1. Summary of sealant/filler specifications, cost and performance life.
(CALTRANS Maintenance Technical Advisory Guide (TAG))

Material	Specification (CT/AASHTO)	Application Type	Approximate Cost (\$/kg) (2003 dollars)	Approximate Life (Years)
Asphalt Emulsion	CT section 94/ M140, M208	Filling	0.15-0.30	2-4
Asphalt Cements	CT section 94/ M20, M226	Filling	0.03-0.15	2-4
Fiber Modified Asphalt	No Specification	Filling	0.35-0.60	6-8
Polymer Modified Emulsion (PME)	CT section 94/ M140, M208	Filling (Minor Sealing)	0.80-1.20	3-5
Asphalt Rubber (AR)	CT SSP 37-400	Sealing	0.45-0.60	6-8
Specialty AR Low Modulus	CT SSP 37-400	Sealing	0.75-1.40	5-9
Silicone	CT SSP 41-200, SSP 51-740	Sealing	5.75-6.75	4-6

Other Sources of Information

- CALTRANS *Maintenance Technical Advisory Guide (TAG)* – Provides guidance on material and construction procedures - http://www.dot.ca.gov/hq/maint/mtag/ch3_crack_sealing.pdf
- FAA AC 150/5380-6B - *Guidelines and Procedures for Maintenance of Airport Pavements* - http://www.faa.gov/airports_airtraffic/airports/resources/advisory_circulars/media/150-5380-6B/150_5380_6b.pdf

3.2.2 Slurry Seals - A slurry seal is a mixture of asphalt emulsion, fine aggregate and mineral filler that has a creamy fluid like appearance. The slurry seal material is mixed and placed on a continuous basis in a slurry mixture machine (Fig 3-1) over an existing pavement. The slurry material flows over and bonds with the existing pavement to form a thin (1/8”) hard surface. Slurry seals are used to seal small cracks, correct surface conditions, and improve the skid resistance of pavement surfaces. Slurry seals are a mixture of asphalt emulsion, graded aggregate, mineral filler, water and other additives. Microsurfacing is an advanced form of slurry seal that also includes a polymer additive.

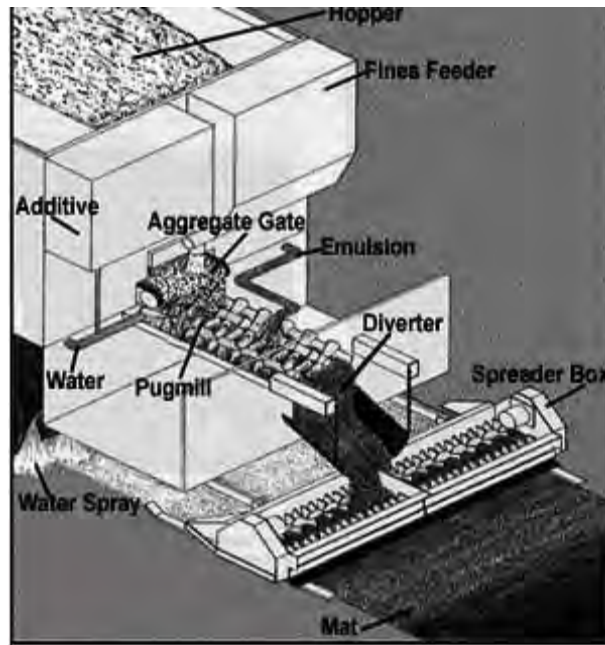

Figure 3-2. Schematic of Slurry Surfacing Machine.
 (CALTRANS Maintenance Technical Advisory Guide (TAG))

Slurry seals are effective in prolonging pavement life. The primary benefit of slurry seals is for pavement preservation as part of a program of periodic surfacing before serious pavement distresses appear. Slurry seals are especially effective in sealing pavements, retarding raveling, improving skid resistance and slowing the aging process (oxidation and volatilization) of the pavement. Slurry seals are not effective in pavements with extensive wide cracks, alligator cracks, extensive potholes and base failure. Slurry seals last approximately 5 to 7 years.

Other Sources:

- CALTRANS *Maintenance Technical Advisory Guide (TAG)* provides guidance on materials and construction procedures – http://www.dot.ca.gov/hq/maint/mtag/ch7_slurry_surfacing.pdf
- FAA AC 150/5380-6B - Guidelines and Procedures for Maintenance of Airport Pavements - http://www.faa.gov/airports_airtraffic/airports/resources/advisory_circulars/media/150-5380-6B/150_5380_6b.pdf

3.2.3 Fog Seals - Fog seals are a light spray application of dilute asphalt emulsion to rejuvenate the surface of an asphalt pavement. Emulsion is a combination of asphalt cement, water and additives. Minute asphalt globules are suspended in water. During the curing process, commonly called “breaking,” the water evaporates, leaving a coat of asphalt, and the emulsion turns from brown to black. Additives will 1) facilitate the dispersion of water and asphalt; 2) control the cure or break time; and 3) rejuvenate or soften the existing asphalt binder.

Fog seals will seal an existing asphalt surface to reduce raveling, waterproof the surface and retard aging. Fog seals coat the aggregate and rejuvenate the existing asphalt binder. Fog seals also reduce the permeability to water and air, which improves the waterproofing of the surface and reduces the aging susceptibility of the pavement.

During its application, the fog seal must have sufficiently low viscosity to penetrate the surface voids of the pavement before it breaks. This is accomplished by using a slow setting emulsion that is diluted with water. Emulsions that are not adequately diluted with water may not properly penetrate the surface voids which will result in excess asphalt on the surface of the pavement. This will produce an unacceptable slippery surface.

Fog seals will not correct distresses such as cracking, base failures and excessive raveling. However, it will slow the aging and oxidation process, which will retard development of transverse and block cracking. Fog seals last approximately 1 year.

Fog seals should be placed in warm dry weather. Fog seals should not be placed when the air temperature is below 50 degrees Fahrenheit or the pavement temperature is below 59 degrees Fahrenheit. Fog seals should not be placed if there is a possibility of rain. If rain occurs prior to the emulsion breaking, the emulsion may be washed off into neighboring drainage ditches. The emulsion may also be flushed out of the pavement voids and coat the aggregate surface, again creating an unacceptably slick landing surface.

Other Sources:

- CALTRANS *Maintenance Technical Advisory Guide (TAG)* provides guidance on materials and construction procedures for fog seals – http://www.dot.ca.gov/hq/maint/mtag/ch6_fog_seals.pdf
- FAA AC 150/5380-6B - Guidelines and Procedures for Maintenance of Airport Pavements http://www.faa.gov/airports_airtraffic/airports/resources/advisory_circulars/media/150-5380-6B/150_5380_6b.pdf

3.2.4 Chip Seals - Chip seals are a thin protective surface treatment constructed by spraying an application of asphalt binder on the pavement, then covering it with crushed aggregate. Chip seals are not recommended for airports because of the risk that loose aggregate may damage aircraft.

3.2.5 Patching - Patching is the process of either filling a pothole with asphalt material or removing a localized distressed pavement area and replacing with asphalt material.

Temporary patches (throw and roll) are constructed by filling the pothole with patching material (hot mix asphalt, cold mix asphalt or proprietary patching material) and then compacting the patch with truck tires (6 to 8 passes). The temporary patch should be 1/8” to 1/4” higher than the surrounding pavement surface to facilitate drainage away from the

pothole. Temporary patches are only appropriate when weather conditions are too poor for a semi-permanent patch.

Semi-permanent patches are constructed by:

- Cutting rectangular shaped area in the pavement around the pothole or distressed area.
- Removing all pavement, water and debris from hole.
- Applying a tack coat to the sides and bottom of the hole.
- Placing patch material in the hole and compacting with small vibratory compactor.
- Sealing patch with sealant.

Other Sources:

- CALTRANs *Maintenance Technical Advisory Guide (TAG)* provides guidance on materials and construction procedures for patching – http://www.dot.ca.gov/hq/maint/mtag/ch4_patching.pdf
- FAA AC 150/5380-6B - *Guidelines and Procedures for Maintenance of Airport Pavements* - http://www.faa.gov/airports_airtraffic/airports/resources/advisory_circulars/media/150-5380-6B/150_5380_6b.pdf

3.2.6 Non-structural Pavement Overlays - Non-structural pavement or thin maintenance overlay is a thin HMA overlay placed on structurally sound pavement. These pavements are less than 1.5 inches thick. They can be used to mitigate raveling, oxidation, minor cracking, and minor surface irregularities, and to improve skid resistance and water proofing.

Other Sources:

- CALTRANs *Maintenance Technical Advisory Guide (TAG)* provides guidance on materials and construction procedures for thin maintenance overlays – http://www.dot.ca.gov/hq/maint/mtag/ch8_maint_overlays.pdf

Chapter 4

CONSTRUCTION

4.1 Surface Preparation

4.1.1 Surface Preparation for New Pavements

A key factor in the strength and performance of an asphalt pavement is the load-bearing capacity of the subgrade. Increasing the subgrade load-bearing capacity improves the overall pavement strength and results in the thinnest and most economical pavement structure possible.

The finished subgrade should be graded to meet elevations, grades and slopes specified in the contract plans. All debris, large rocks, vegetation and topsoil should be removed from the subgrade to prevent non-uniform compaction. In areas where vegetation could affect subgrade support, the subgrade should be treated with an approved herbicide to prevent or retard future vegetation growth.

Compaction – To provide the maximum structural support, the sub grade must be compacted to a minimum required density. If the subgrade soil is not compacted, pavement cracks and surface deformation may occur due to compression or deformation after construction.

The minimum required density for subgrades supporting airport pavements ranges from 85% to 100%, depending on the depth below the paved surface and the weight of the design aircraft. Table 3-2 of AC 150/5320-6D summarizes the depth and density required. To achieve these densities, the subgrade must be at or near its optimum moisture content.

If the compacted subgrade is not adequate to support the pavement structure, it can be improved by either:

- Stabilizing soils with lime, cement or emulsified asphalt depending on the PI of the subgrade soils.
- Subexcavating all or a portion of the weak subgrade and replacing it with better soils.

Prime Coats – A prime coat, emulsified asphalt sprayed on the surface, has three primary purposes:

1. Fill the surface voids and protect the subbase from weather.
2. Stabilize the fines in the subgrade and preserve the subbase material from infiltration of fine material from the subgrade.
3. Promote bonding between the subgrade and pavement layers.

Other Sources on sub grade preparation:

[http://pavementinteractive.org/index.php?title=Subgrade Preparation for New Pavements](http://pavementinteractive.org/index.php?title=Subgrade_Preparation_for_New_Pavements)

4.1.2 Surface Preparation for Pavement Overlays

The existing pavement should be structurally sound, level, clean, and capable of bonding to the overlay. The existing pavement should be repaired, leveled (by milling, preleveling or both), cleaned, then coated with a tack coat.

4.1.3 Repair

Pavement overlays are designed to add only a small portion of additional structural support. The primary structural support is the existing pavement structure. Small areas of localized structural failure and cracks in the existing pavement should be repaired or replaced to provide structural support and maximize the useful life of the pavement. In areas where the existing pavement failed due to poor subgrade, the existing pavement structure should be removed and replaced.

Cracks in the pavement may reflect through the pavement overlay and cause premature pavement failure in the form of cracks and deformations. The best repair method depends on the type and severity of the cracks. Pavement sections with fatigue cracking should be replaced, because fatigue cracking is usually an indication of more extensive pavement or subgrade structural failure. Other cracks should be cleaned (blown out with pressurized air and/or swept) and filled with a crack-sealing material when the cracks are clean and dry. Thin cracks (less than 3/8" wide) should be widened with a mechanical router and filled with a crack-sealing material. If the existing pavement has an excessive amount of fine cracks but is still structurally adequate, it may be more economical to apply a slurry seal instead of crack-filling each individual crack.

Tack Coat - Before overlaying, a tack coat should be sprayed over the existing pavement to ensure that the overlay is bonded to the existing pavement surface.

Leveling - The existing pavement should be as smooth as possible before being overlaid. The existing pavement is typically leveled by one of the following methods:

- **Leveling Course** - The first lift applied to the existing pavement is used to fill in depressions and provide a smooth surface; it also forms the base for the surface course.
- **Milling** - A portion of the top layer is milled off the existing pavement to provide a smooth surface (Figure 4-1). Milling is also commonly used to remove a distressed surface layer from an existing pavement.



Figure 4-1. Large milling machine.

Pavement Overlays Over PCC Pavements - Placing a hot mix asphalt (HMA) overlay on a jointed or cracked Portland Cement Concrete (PCC) pavement involves some special considerations. PCC pavements tend to crack into discrete sections. These slabs/sections tend to move as individual units. Although HMA overlays can accommodate small differential movement without cracking, the large differential movement at slab and crack interfaces causes reflective cracks in the HMA overlay. Techniques to prevent or retard reflection cracking in HMA overlays of PCC pavement are: 1) stabilize slabs; 2) increase HMA overlay thickness or add granular layer; 3) break the slab into small pieces (2 ft.) and seat with a large roller; and 4) rubberize PCC pavement into gravel sized pieces.

Other sources of information on surface preparation for pavement overlays:

http://pavementinteractive.org/index.php?title=Existing_Surface_Preparation_for_Overlays

4.2 Plant Operations

The primary purpose of a hot mix asphalt (HMA) plant is to proportion, blend, and heat aggregate and mix with asphalt cement to produce a homogeneous HMA.

There are two basic types of HMA plants – the batch plant and the drum mix plant. Batch plants produce HMA in individual batches while drum plants produce HMA in a continuous operation. Each type can produce the same types of HMA.

Approximately 70 percent of all operational HMA plants in the U.S. are batch plants while about 95 percent of all newly manufactured plants in the U.S. are drum plants. As older batch plants are retired, they are more than likely to be replaced by new drum plants, which can provide greater mobility and production capacity. The choice of a batch or drum mix plant depends on purchase price, operating costs, production requirements, and portability.

4.2.1 Batch Plants – Batch plants produce HMA in individual 1.5 to 5 ton batches. Figure 4-2 illustrates a typical batch plant. The key components of a batch plant are:

- Cold Feed Bins – Stockpiled aggregates are loaded into the cold feed bins.

- Dryer – Aggregate is heated by tumbling the aggregate through a gas flame.
- Primary Collector – Removes large dust particles.
- Baghouse (Secondary Collector) – Remove fine particles from the dryer exhaust gases.
- RAP Bin – Recycled Asphalt Pavement (RAP) can be loaded separately into the pug mill.
- Batch Tower
 - Screen Deck – Aggregate is separated into various sizes by vibrating screens. When the proper quantity of each size aggregate is collected, the aggregates are dumped into the pug mill.
 - Pug Mill – Aggregates and asphalt binder are mixed together in 2 to 5 ton batches. It takes approximately 35 seconds to blend and mix each batch. The batches are either loaded directly into trucks or transported to silos by conveyors.
- Storage Silo – The HMA is stored in either:
 - Surge Silo – Insulated but unheated silo used for short-term storage.
 - Storage Silo – Insulated, heated and airtight silo used for long-term storage.

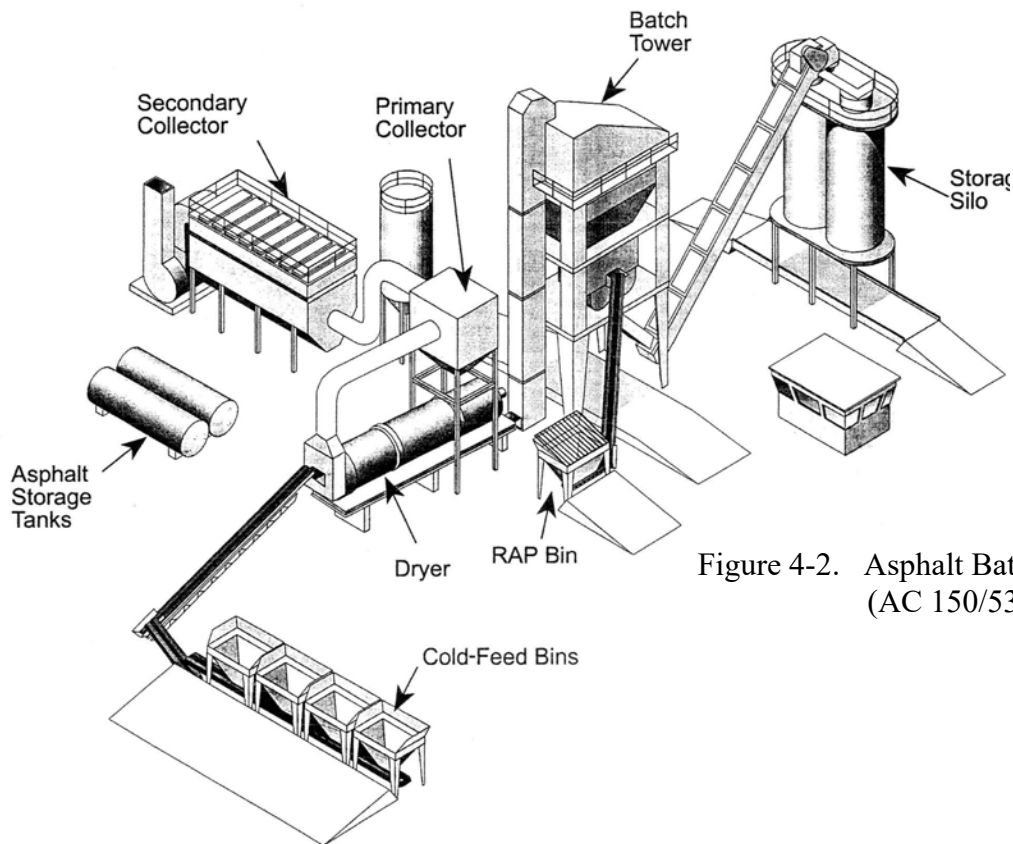

Figure 4-2. Asphalt Batch Plant.
(AC 150/5370-14A)

Another source of information on batch plants is:

http://pavementinteractive.org/index.php?title=HMA_Batch_Plant

4.2.2 Drum Mix Plants - Drum mix plants produce HMA in a continuous flow. Production rates vary between about 100 tons per hour, up to 900 tons per hour, depending upon drum design. Figure 4-3 shows the basic components of a drum plant. The key components of a drum mix plant are:

- Cold Feed Bins – Stock piled aggregates are loaded into the cold feed bins.
- Drum – The rotating drum first heats the aggregate and then mixes the aggregate and asphalt binder.
- Primary Collector – Removes large dust particles.
- Baghouse (Secondary Collector) – Removes fine particles from the dryer exhaust gases.
- RAP Bin – Recycled Asphalt Pavement (RAP) can be loaded separately into the middle of the drum.
- Storage Silo – The HMA is stored in either:
 - Surge Silo – Insulated but unheated silo used for short for short term storage.
 - Storage Silo – Insulated, heated and airtight silo used for long term storage.

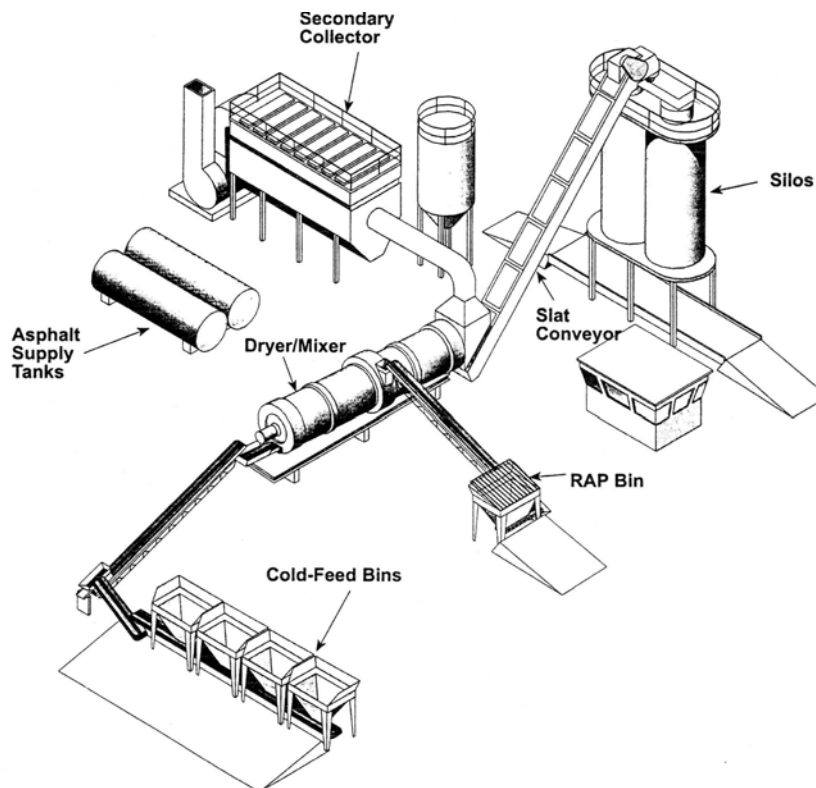

Figure 4-3. Asphalt Drum Mix Plant. (AC 150/5370-14A)

Another source of information on drum mix plants is:

http://pavementinteractive.org/index.php?title=HMA_Drum_Plant

4.3 Asphalt Mix Transportation

The hot mix asphalt (HMA) is transported from the plant to the paving site in trucks – belly dumps, end dumps and flo-boys. Transporting the HMA can affect the temperature of the mix at the paving site, temperature variations (segregation) of the HMA, and aggregate segregation. Key factors affecting the quality of the HMA delivered to the paving site are:

- Loading at the production plant – Trucks beds should be clean and lubricated. The trucks should be loaded in such a manner to avoid aggregate segregation. Trucks loaded from a silo should be loaded by three small dumps at different locations in the truck bed instead of a single large dump.
- Truck transport – The HMA cools as it is transported to the paving site. Haul distance should be minimized as much as possible. For long hauls, the loads should be insulated with tarps and insulated beds.
- Operation synchronization – The HMA production, transport and placement should be synchronized to maintain a constant and consistent flow of HMA to the paver.

Other information on the transport of HMA is located at:

http://pavementinteractive.org/index.php?title=HMA_Transport

4.4 Asphalt Mix Placement

The HMA is placed on the prepared surface with an asphalt laydown machine (paver). This is a self-propelled, formless laydown machine with a floating screed. The HMA is loaded in the front hopper, carried to the rear by a set of conveyor belts, spread out by a set of augers, then leveled and compacted by a screed.

Operation of the laydown machine has a significant effect on overall construction quality and long-term pavement performance. To avoid bumps and waves in the HMA mat, a constant head of HMA must be maintained in front of the screed. To avoid aggregate segregation and variation in mat temperatures, the hopper should not be allowed to be emptied during paving; this results in the leftover cold, large aggregate in the hopper sliding onto the conveyor in a concentrated mass and then being placed on the mat without mixing with any hot or fine aggregate.

The floating screed controls the mat thickness. Adjusting the paver speed, material feed rate or tow point elevation will affect the pavement thickness. To achieve the most consistent thickness and smoothest possible surface, pavers should maintain a constant speed, use automatic feed controls to maintain a consistent head of material in front of the paver, and use automatic screed control to maintain a consistent tow point. Although the screed angle can be adjusted manually to change mat thickness, excessive adjustments will result in a wavy, unsmooth mat. In addition to grade, screeds can also control mat slope and crown to provide control of mat elevation.

4.5 Compaction

Compaction of the asphalt pavement is one of the most critical factors affecting pavement performance. Compaction is the reorientation of the aggregate particles into a closely spaced arrangement. This also reduces the volume of air in the HMA mixture, which increases the unit weight or density. A poorly compacted HMA pavement could result in reduced fatigue life, accelerated aging, rutting, raveling and moisture damage.

There are two methods for reporting pavement density.

- Percent of Maximum Theoretical Density (MTD) – Percentage of the unit weight of the compacted pavement compared to the MTD of the asphalt mix. The MTD is determined by laboratory test and is the maximum density if all air voids are removed from the HMA. This method is used by CALTRANS and most state highway agencies and is commonly referred to as “% of Rice”.
- Percent of bulk specific gravity (BSG) – Comparison of the unit weight of the compacted pavement as a percentage of the laboratory compacted bulk unit weight. The bulk specific gravity includes air voids. This method is used in the FAA specifications.

Pavement density is measured by one of the following methods:

- Cores – A six inch diameter core is drilled and extracted from the compacted pavement. The core is measured for density in a laboratory. Core density testing is the most accurate, reliable and repeatable test for testing the density of the pavement. However, this test is time consuming, expensive and requires the core holes to be patched. This is the most commonly used method to determine the acceptability of the pavement.
- Nuclear gauges - A nuclear density gauge measures the in place density of the pavement. Nuclear gauges usually contain a small gamma. Nuclear density readings are obtained in 2 - 3 minutes. However, this method is not considered accurate and reliable for acceptance testing. This method is commonly used by the contractor for quality control and to establish a roller pattern.

The primary factors affecting compaction are weather (temperature and wind), HMA mix properties, and the compaction equipment.

4.5.1 Weather – The HMA mat temperature is critical to the amount of compaction and the time available for compaction. The key weather factors that affect the HMA mat temperature are air temperature, surface temperature and wind speed. As the HMA cools, the asphalt binder becomes stiffer and more resistant to compactive effort.

The temperature of the HMA at the completion of the mixing stage is 325 to 375 degrees, depending on the type of asphalt binder. The temperature of the HMA during compaction should be 175 to 320 degrees. In general, when the HMA mix cools to 175 degrees (cessation temperature) it becomes too stiff to compact.

The major factors that affect the time available for compaction are:

- Initial mat temperature - Higher initial mat temperatures allows more time to compact the mix. However, overheating the HMA will damage the asphalt binder and cause unacceptable emissions.
- Mat or lift thickness - Thicker pavement lifts lose heat slower than thin lifts and increases the time available for compaction.
- Temperature of the surface - Cooler surfaces will remove heat from the mat at a faster rate that decreases the time available for compaction.
- Air temperature - Cooler air temperatures will remove heat from the mat at a faster rate and decrease the time available for compaction.
- Wind speed – Strong wind will cool the HMA and decrease the time available for compaction.

4.5.2 HMA Mix Properties – The following aggregate and asphalt binder properties affect the way the aggregate interlocks and the ease at which the aggregate can be rearranged under compactive effort:

- Coarse aggregate - Rough surface textures, cubical or block-shaped aggregate (as opposed to round aggregate) and highly angular particles (high percentage of fractured faces) increases the required compactive effort to achieve a specific density.
- Midsize fine aggregate (between No. 30 to No. 50 sieves) - High amounts of midsize rounded aggregate (natural sand) can cause an HMA mix to displace laterally or shove instead of compact under roller loads. This material takes up some of the voids needed for the asphalt binder. If the voids are filled, the excess asphalt binder resists compaction by forcing the aggregate apart and to displace laterally.
- Fines or dust (aggregate passing the (No. 200) sieve) – A HMA with a high fines content will be more difficult to compact than a HMA with a low fines content.
- Viscosity of the asphalt binder. - A HMA with a binder with a higher viscosity will be more resistant to compaction.
- Asphalt binder content - The asphalt binder lubricates the aggregate during compaction. HMA mixes with low asphalt content are generally more difficult to compact.

A combination of mix design factors can produce a “tender mix” which may displace laterally and shove rather than compact under roller loads.

Other Sources: http://pavementinteractive.org/index.php?title=HMA_Compaction
http://pavementinteractive.org/index.php?title=Factors_Affecting_Compaction

4.5.3 Compaction Equipment

There are four stages of compaction of HMA pavement:

- Paver - The paver screed provides the initial compaction. Approximately 75% to 85% of the maximum theoretical density (MTD) can be obtained when the mix passes out from under the paver screed.
- Breakdown rolling – Breakdown compaction is performed by steel wheel rollers or vibratory steel wheel rollers between 275-320 degrees.
- Intermediate rolling – Intermediate compaction is performed by steel wheel rollers or pneumatic tire roller between the 200-275 degrees.
- Finish rolling – Finish rolling is performed by small steel wheel rollers between 150-200 degrees. Finish rolling does not increase pavement density. Rather the purpose is to remove roller marks left by the intermediate roller and to improve the surface texture. Steel Wheel Rollers – Steel wheel rollers are self-propelled compaction equipment that use steel drums to compress the underlying HMA. Most rollers have two drums. The drums can be either static or vibratory and usually range from 35 to 85 inches in width and 20 to 60 inches in diameter. Roller weight is typically between 1 and 20 tons.

Some steel wheel rollers are equipped with vibratory drums. Drum vibration adds a dynamic load to the static roller weight to create a greater total compactive effort. Drum vibration also reduces friction and aggregate interlock during compaction, which allows aggregate particles to move into final positions that produce greater friction and aggregate interlock. Operators can turn the vibrations on or off and can also control amplitude and frequency. The ideal vibratory frequency and amplitude are a compromise based on desired mat smoothness, HMA characteristics and lift thickness. Vibratory steel wheel rollers must be used with caution near shallow underground utilities.

Pneumatic (Rubber) Tire Roller - Pneumatic tire rollers are self-propelled compaction devices that use pneumatic tires to compact and knead the HMA. Pneumatic tire rollers employ a set of smooth (no tread) tires on each axle; typically four or five on one axle and five or six on the other. The tires on the front axle are aligned with the gaps between tires on the rear axle to give complete and uniform compaction coverage over the width of the roller. Compactive effort is controlled by varying tire pressure, which is typically set between 60 and 120 psi. In addition to a static compressive force, pneumatic tire rollers also develop a kneading action between the tires that tends to realign aggregate within the HMA. This results in both advantages and disadvantages when compared to steel wheel rollers.

The primary advantages of rubber tired rollers are:

- Provide a more uniform degree of compaction than steel wheel rollers.
- Provide a tighter and denser pavement surface which decreases the permeability of the pavement.
- May provide increased density under certain conditions with some HMA that may not be obtained with steel wheel rollers.
- Compact the mixture without causing hairline surface cracks (checking) and may remove any checking that is caused by steel wheel rollers.

The primary disadvantages of rubber tired rollers are:

- Individual tire arrangement may cause deformations in the mat that are difficult or impossible to remove with further rolling. They should not be used for finish rolling.
- If the asphalt binder contains a rubber modifier, the HMA may stick to the tires.

Other information on compaction equipment, including photos, causes and solutions, is available at: [http://pavementinteractive.org/index.php?title=Compaction Equipment](http://pavementinteractive.org/index.php?title=Compaction_Equipment) and http://www.asphaltwa.com/wapa_web/modules/07_construction/07_compaction.htm

4.6 Construction Problems

4.6.1 Fat Spots – Fat spots are isolated areas in the mat where excess asphalt binder is visible on the surface. A few scattered fat spots may not significantly affect mat durability or pavement structure. However, a large number of fat spots may be indicative of excessively low air voids which could result in shoving and rutting. Fat spots have a smooth surface texture and affect pavement skid resistance.

Other information, including photos, causes and solutions, is available at: http://pavementinteractive.org/index.php?title=Fat_Spots

4.6.2 Joints - Typically, poor transverse joints result in a slight bump, which can affect roughness. Poor longitudinal joints are generally lower in density, may fail prematurely from raveling or cracking, and may allow water infiltration into the base and subgrade. Information on roughness, raveling, cracking and water infiltration into the base and subgrade may be found at:

<http://pavementinteractive.org/index.php?title=Roughness>

<http://pavementinteractive.org/index.php?title=Raveling>

[http://pavementinteractive.org/index.php?title=Fatigue cracking](http://pavementinteractive.org/index.php?title=Fatigue_cracking)

<http://pavementinteractive.org/index.php?title=Base>

<http://pavementinteractive.org/index.php?title=Subgrade>

Other information, including photos, causes and solutions, is available at:

[http://pavementinteractive.org/index.php?title=Joint Problems](http://pavementinteractive.org/index.php?title=Joint_Problems)

[http://pavementinteractive.org/index.php?title=Longitudinal Joint Construction](http://pavementinteractive.org/index.php?title=Longitudinal_Joint_Construction)

4.6.3 Microcracking (Checking) - Refers to short transverse cracks, usually 1 to 3 inches long and 1 to 3 inches apart that appear on the mat surface during compaction. These cracks are usually shallow and small. Microcracking may indicate mix tenderness which can eventually lead to inadequate compaction because the mixture “shoves” rather than compacts under roller loads or because the mix is too cold to compact. Pavements that are not compacted properly are susceptible to reduced fatigue life, accelerated aging, decreased durability, rutting, raveling, and moisture damage.

Technical information for fatigue life, aging, durability, rutting, raveling and moisture damage may be found at:

http://pavementinteractive.org/index.php?title=Fatigue_life&action=edit
<http://pavementinteractive.org/index.php?title=Aging>
<http://pavementinteractive.org/index.php?title=Durability>
<http://pavementinteractive.org/index.php?title=Rutting>
<http://pavementinteractive.org/index.php?title=Raveling>
<http://pavementinteractive.org/index.php?title=Stripping>

Other information, including photos, causes and solutions, is available at:

<http://pavementinteractive.org/index.php?title=Microcracking>

4.6.4 Non-uniform texture – Non-uniform texture or rough areas can be an indication of low density, aggregate segregation or temperature differentials, which can all substantially reduce pavement life.

Other information, including photos, causes and solutions, is available at:

http://pavementinteractive.org/index.php?title=Non-Uniform_Texture

4.6.5 Roller Marks — Roller marks are indentations in the mat surface that remain after rolling operations are complete. Most roller marks are removed from the mat surface by [finish rolling](#).

Other information, including photos, causes and solutions, is available at:

http://pavementinteractive.org/index.php?title=Roller_Marks

4.6.6 Pavement Shoving – This is a form of plastic movement typified by ripples (corrugation) or an abrupt wave (shoving) across the pavement surface. The distortion is perpendicular to the traffic direction and usually occurs at points where traffic starts and stops. Pavements that shove under compaction loading are generally unstable and are likely to continue to deform under traffic loading leading.

Other information, including photos, causes and solutions, is available at:

http://pavementinteractive.org/index.php?title=Mat_Shoving
http://pavementinteractive.org/index.php?title=Corrugation_and_Shoving

4.6.7 Surface Waves - Surface waves will cause an increase in [roughness](#). The pavement's structural capacity is only affected if the waves are severe enough to cause aircraft to bounce which increases impact loading.

Other information about surface waves, including photos, causes and solutions, is available at: http://pavementinteractive.org/index.php?title=Surface_Waves

4.6.8 Mat Tearing - Mat tearing usually results in decrease density. The torn areas may have a lower density and are susceptible to reduced [fatigue life](#), accelerated [aging](#), decreased [durability](#), [rutting](#), [raveling](#), and [moisture damage](#).

Other information, including photos, causes and solutions, is available at:
http://pavementinteractive.org/index.php?title=Mat_Tearing

4.6.9 Transverse Screed Marks - Transverse screed marks are transverse indentations in the mat surface across the width of the mat. These indentations occur when the paver stops between truckloads of HMA and the screed rests on the hot mat. They provide a rough pavement surface but do not affect the pavement structure.

4.7 Summary – The information presented in this chapter represents an overview of the construction of hot asphalt pavements. It is not intended to be a complete compilation of the body of knowledge nor can it replace experience. It does however provide the reader with a starting point to understand the fundamentals of asphalt pavement construction. It is imperative that each step from the mix design through the hot mix plant to laydown be carefully monitored to ensure good construction practices are followed and that any deficiencies be corrected immediately. While, in most cases the specifications make the contractor responsible for correcting any defects in the pavement, the inspector must be able to recognize those defects and inform the contractor of those deficiencies and insist they be corrected. To do so, inspectors should be thoroughly trained to understand the causes of defects and how to correct them. Failure to correct any deficiencies will shorten the life of the pavement and can often lead to expensive corrective action a few years later. Recognize that the quality of the project will be judged by the quality of the pavement in terms of looks and smoothness. Even so, your budget will be negatively impacted by early pavement failure. Take care to get the best quality project practical.

Other information on transverse screed marks, including photos, causes and solutions is available at: http://pavementinteractive.org/index.php?title=Transverse_Screed_Marks

Appendix A

PAVEMENT DESIGN

A.1 General

Airport pavements are compacted layers of material designed to provide a smooth, skid-resistant surface. The pavement must support aircraft loads, withstand the abrasive action of traffic and resist adverse weather conditions.

A.1.1 – The Difference Between Asphalt Pavement and Concrete Pavement -

Airport pavements are classified as either rigid (Portland cement concrete - PCC) or flexible (asphalt) pavements. The key difference between the two types is how they distribute the aircraft wheel loads to the subgrade.

Rigid pavements use Portland cement concrete (PCC) as a rigid, stiff slab on the surface that distributes the aircraft wheel load through flexural action to the subgrade. The PCC slab carries a majority of the load. The PCC slab is constructed on top of a compacted granular or treated subbase which is supported by the compacted subgrade. Figure 2-1 illustrates the distribution of the aircraft wheel loads on a rigid pavement to the underlying subgrade. Most PCC pavements have joints to accommodate expansion and contraction of the concrete slab during different temperature conditions. The different types of PCC pavements include: 1) plain (without reinforcement steel); 2) reinforced (with reinforcement steel); 3) continuous reinforcement; 4) prestressed; or 5) fibrous reinforced concrete. The amount and type of reinforcement affects the joint spacing and thickness of the concrete slab.

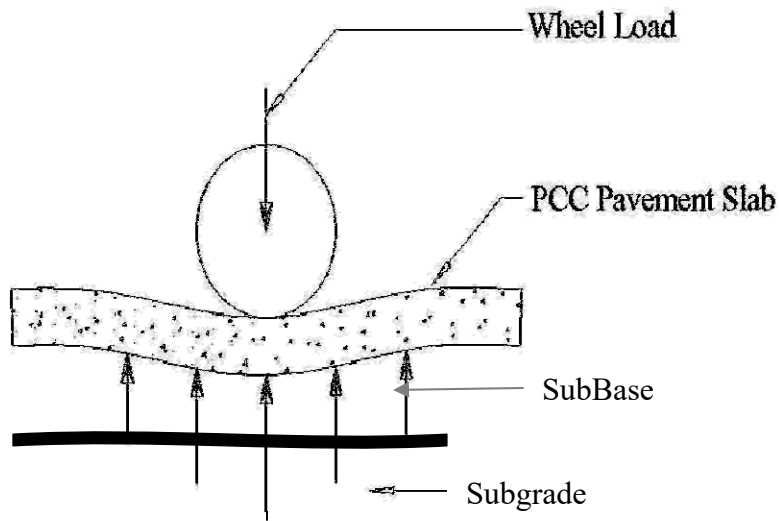

Figure A-1. Transfer of Wheel Load to Subgrade in concrete pavements.
(AC 150/5380-6B)

Flexible pavements consist of several layers of granular materials designed to gradually distribute the aircraft wheel loads from the pavement surface to the subgrade. The top layer is bound by asphalt material. The hot mix asphalt (HMA) pavement structure is designed to ensure that the load transmitted to each successive layer does not exceed the bearing capacity of the underlying layer. Figure A-2 illustrates the distribution of the aircraft wheel loads of a flexible pavement to the underlying subgrade.

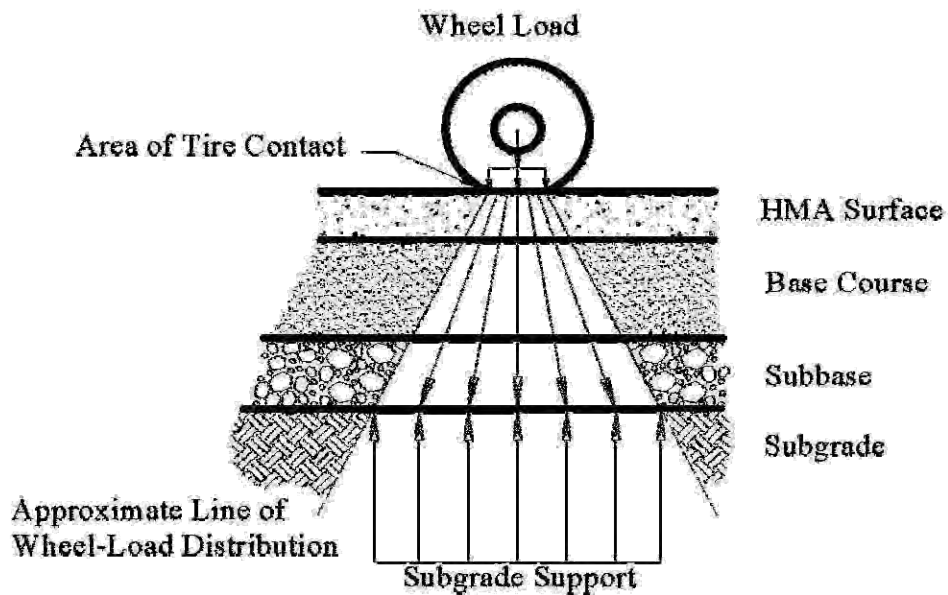

Figure A-2. Distribution of Wheel Loads in Asphalt Pavements.
(AC 150/5380-6B)

The key differences between a PCC pavement and asphalt pavement are:

- Initial construction costs for asphalt pavements are generally less than for PCC pavements.
- Asphalt pavements are generally cheaper and easier to maintain than PCC pavements.
- Asphalt pavements are generally easier to repair than PCC pavements.
- Asphalt pavements are more flexible and can better withstand extreme changes in temperatures better.
- PCC pavements can carry heavier aircraft.

A.2 Asphalt Pavement Structure

The key components of the asphalt pavement structure are:

- Hot Mix Asphalt (HMA) Pavement – The HMA pavement is a bituminous surface or wearing course consisting of a mixture of selected aggregates bound together with asphalt cement. The HMA pavement distributes the load to the underlying base course; prevents the penetration of water into the underlying pavement structure; provides a smooth, well-bonded surface free of loose particles; and provides a skid-resistant surface. The HMA layer ranges in thickness from 2 to 4 inches depending on the weight of the design aircraft (see Table 2-1). The minimum thickness for airport pavements with a design aircraft of 30,000 pounds or less is 2 inches.
- Base Course – The base course is the primary structural component of the flexible pavement. It distributes the load to the underlying subbase/subgrade. Base course performance depends on the physical properties and relative density (compaction) of the material. The base course materials are generally hard, durable, crushed aggregates. In some cases, the base course is treated with cement or other asphalt material to improve the load-bearing capacity. The base course ranges in thickness from 3 to 8 inches depending on the weight and gear type of the design aircraft (Table 2-1). For airport pavements with design aircraft of 30,000 pounds or less, the base course ranges in thickness from 3 to 6 inches.
- Subbase – The subbase consists of granular material that distributes the loads to the underlying subgrade, reduces frost penetration into the subgrade, and prevents subgrade material from pumping into the base course. Subbase thickness depends on the design aircraft weight, strength of the subgrade, and the subgrade's frost susceptibility (see Table A-1). For airport pavements with design aircraft of 30,000 pounds or less, the subbase layer ranges in thickness from 0 to 14 inches.
- Frost Protection Layer – In areas that have freezing temperatures, frost-susceptible soil and a high groundwater table; the thickness of the subbase may be increased, or an additional layer of granular material may be used to prevent frost heaving and thaw weakening. The frost protection layer reduces or eliminates frost from penetrating into the frost-susceptible subgrade.

- Subgrade – The subgrade is the soil that forms the foundation of the pavement system. The combined thickness of subbase, base, and wearing surface must be great enough to reduce the stresses occurring in the subgrade to values that will not cause excessive distortion or displacement of the subgrade soil layer.

A.3 Pavement Design Parameters

Three key factors affect asphalt pavement design: aircraft loads (wheel loads), subgrade strength, and environmental conditions.

A.3.1 Aircraft Loads – Aircraft load affects the type of hot mix asphalt (HMA) pavement and the thickness of the various pavement layers.

There are two methods of evaluating aircraft load for airport pavement design – gross weight of the aircraft and wheel loads. Aircraft wheel loads are the loads at the tire–pavement contact points. Most light aircraft have single-wheel gears. However, for aircraft with dual wheel gears (two wheels per gear) and heavier aircraft with dual tandem wheel gears (four wheels per gear), the number and location of the wheels per aircraft gear is a critical element for pavement design. For the multi-wheeled gears, the influence of the wheel loads on the pavement overlap. The load design characteristic for these gears is the combined effect of the interacting wheel loads, rather than the single isolated wheel load.

Repeated aircraft loading damages pavement over time. Each individual wheel load inflicts a small amount of unrecoverable damage. This damage accumulates over the life of the HMA pavement. The pavement reaches the end of its performance life when the accumulated damage reaches the maximum damage value.

Aircraft speed influences aircraft loading on the pavement. Slower speeds and stop conditions allow the aircraft load to be applied to a given pavement area for a longer period of time, resulting in greater damage. For HMA pavements, this behavior is sometimes evident on aprons and taxiways, where aircraft have to stop and wait.

A.3.2 Subgrade Strength – The strength and permeability characteristics of the subgrade affect the thickness of the base and subbase pavement layers.

The subgrade soils are classified using the Unified Soil Classification System presented in Figure 2.3 of AC 150/5320-6D. The laboratory tests conducted to classify the subgrade soils are:

- Gradation – This test quantifies the particle size distribution of the soils.
- Liquid Limit (LL) – This test determines the lowest moisture content at which the silt/clay soil will act as a liquid.
- Plastic Limit (PL) – This test determines the lowest moisture content at which silt/clay soil will act in the plastic state.

- Plastic Index (PI) – PI is the difference between the LL and PI and represents the range in moisture content at which silt/clay soil will act as a plastic material.
- Moisture-density relationship – This test determines the moisture: density relationship of the soil.

Subgrade performance depends on the following three characteristics:

- Load bearing capacity – The subgrade must be able to support loads transmitted from the pavement structure. This load-bearing capacity is often affected by degree of compaction, moisture content, and soil type.
- Moisture content – Moisture affects load bearing capacity, shrinking characteristics and swelling characteristics. Oversaturated subgrades will deform under aircraft load. Moisture content is influenced by drainage, groundwater table elevation, infiltration, or pavement porosity (which is often affected by cracks in the pavement).
- Shrinkage and/or swelling – Some soils shrink or swell depending upon their moisture content. Clayey soils with LL above 40 and PI above 25 are prone to swell in the presence of moisture. In addition, soils with excessive silt material may be susceptible to frost heaving in cold climates. Shrinkage, swelling and frost heaving will deform and crack the HAP.

Soil tests used to characterize the strength and suitability of subgrade soils are the California Bearing Ratio and resilient modulus.

A.3.2.1 California Bearing Ratio – The California Bearing Ratio (CBR) test is a simple strength test that compares the bearing capacity of a material with that of a well-graded crushed stone. A high quality crushed stone material should have a CBR of 100%. The CBR is primarily intended for, but not limited to, evaluating the strength of clay materials.

The basic CBR test involves applying load to a small penetration piston. Figure A-3 illustrates the CBR testing procedure.

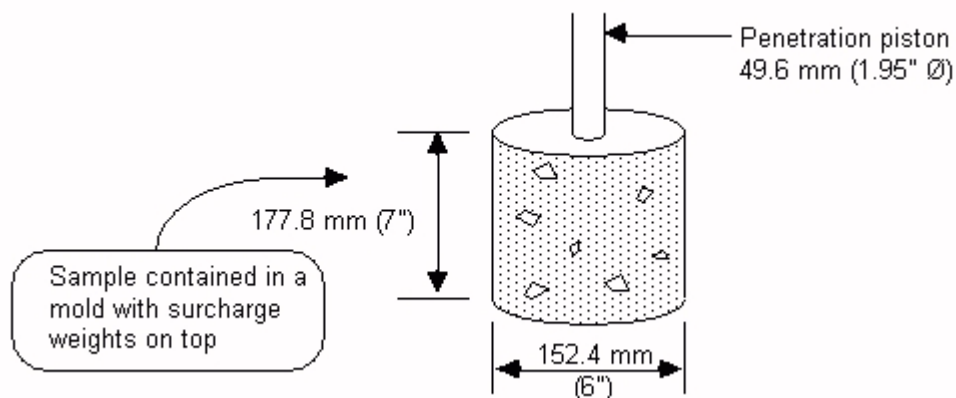

Figure A-3. CBR test.

http://pavementinteractive.org/index.php?title=California_Bearing_Ratio

A.3.2.2 Resilient Modulus - The Resilient Modulus (MR) is a subgrade material stiffness test. A material's resilient modulus is an estimate of its modulus of elasticity. While the modulus of elasticity is *stress divided by strain for a slowly applied load*, resilient modulus is *stress divided by strain for rapidly applied loads* – like those experienced by pavements.

A.3.3 Environmental Conditions – Environmental conditions such as temperatures, moisture and ice formation affect pavement durability, asphalt binder type, structural support and pavement life.

A.3.3.1 Temperature Variations – HAP will expand in the summer and contract in the winter. Extreme temperature variations can cause large transverse (thermal) cracks as a result of excessive contraction in cold weather. Estimated temperature extremes and their effects are a primary consideration for selecting the asphalt binder type. Older asphalt binder grading systems (penetration, viscosity, PBA and AR) did not directly account for temperature effects. The Superpave PG binder grading system corrects this deficiency by grading asphalt binder based on its performance in relation to both high and low temperature performance. In addition, asphalt binder flow characteristics (rheology) vary with temperature.

A.3.3.2 Frost Action - Severe frost action can destroy a new pavement in a matter of one or two years. Frost action can have detrimental impacts to pavements in the form of frost heaving during the winter and thaw weakening during the spring.

Frost heave is the upward movement of the pavement surface caused by the expansion of soil moisture in the frost-susceptible subgrade as it freezes. As the frost-susceptible subgrade freezes, ice lenses form. As the ice lens grows, the overlying soil and pavement will heave, resulting in a cracked rough pavement.

The degree of soil frost-susceptibility depends on the percentage of fine particles within the soil. Soils are considered frost-susceptible if 10 percent or more of the material passes a No. 200 sieve, or 3 percent or more passes a 0.02 mm sieve. Frost heaving occurs primarily in soils containing silt particles. Clean sands and gravels are non-frost susceptible and generally do not heave. Figure A-4 illustrates the formation of ice lenses in a frost-susceptible soil.

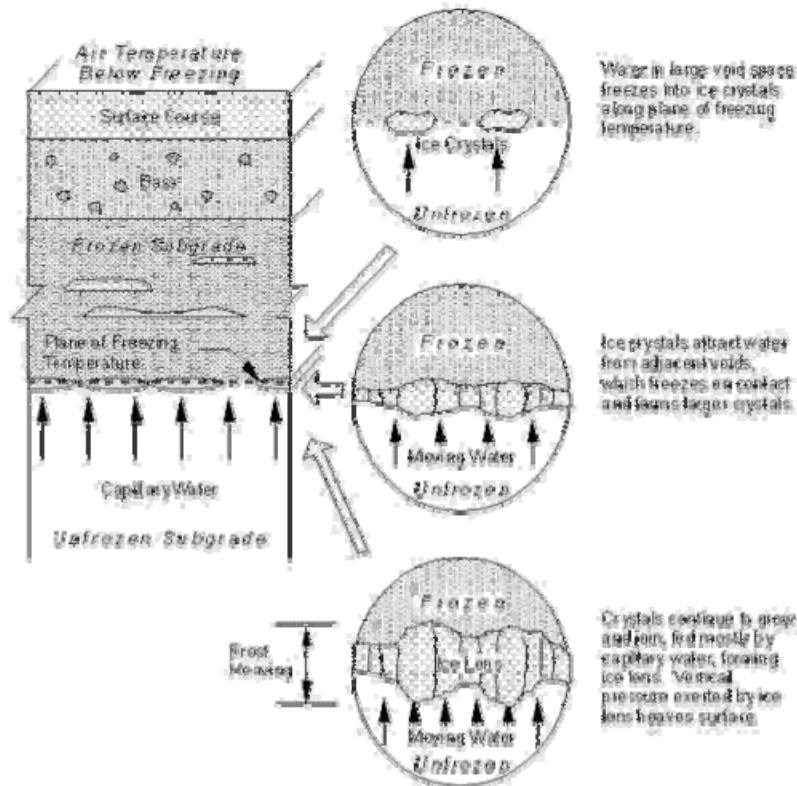

Figure A-4. Formation of ice lenses in a pavement structure.
http://pavementinteractive.org/index.php?title=Frost_Action

The three elements necessary for formation of ice lenses and frost heaves are:

1. Frost-susceptible soil with significant amounts of silt and clay.
2. Subfreezing temperatures that will penetrate the frost-susceptible soil.
3. Water, from groundwater, or run-off held within the voids of fine-grained soil.

If the above three conditions occur uniformly, heaving will be uniform; otherwise, differential heaving will occur, resulting in pavement cracking and roughness.

Differential heave is more likely to occur at locations such as:

- Where subgrades change from clean non-frost susceptible (NFS) material to silty frost susceptible materials.
- Abrupt transitions from embankment cuts to fills where groundwater is close to the surface.
- Areas near drains and culverts, which frequently result in abrupt differential heaving due to different backfill material, compaction, and the fact that open buried pipes change the thermal conditions of the soils by bringing cold air closer to the subgrade.

Thaw weakening is the melting of ice contained within the subgrade. As the ice melts and turns to liquid, it cannot drain out of the soil fast enough. The subgrade becomes saturated and weak and loses bearing capacity. Under these circumstances, aircraft

loading that would not normally damage a pavement may cause significant fatigue cracking and potholing. Figure A-5 illustrates the changes that can occur in subgrade strength during the year caused by winter freezing and spring thawing.

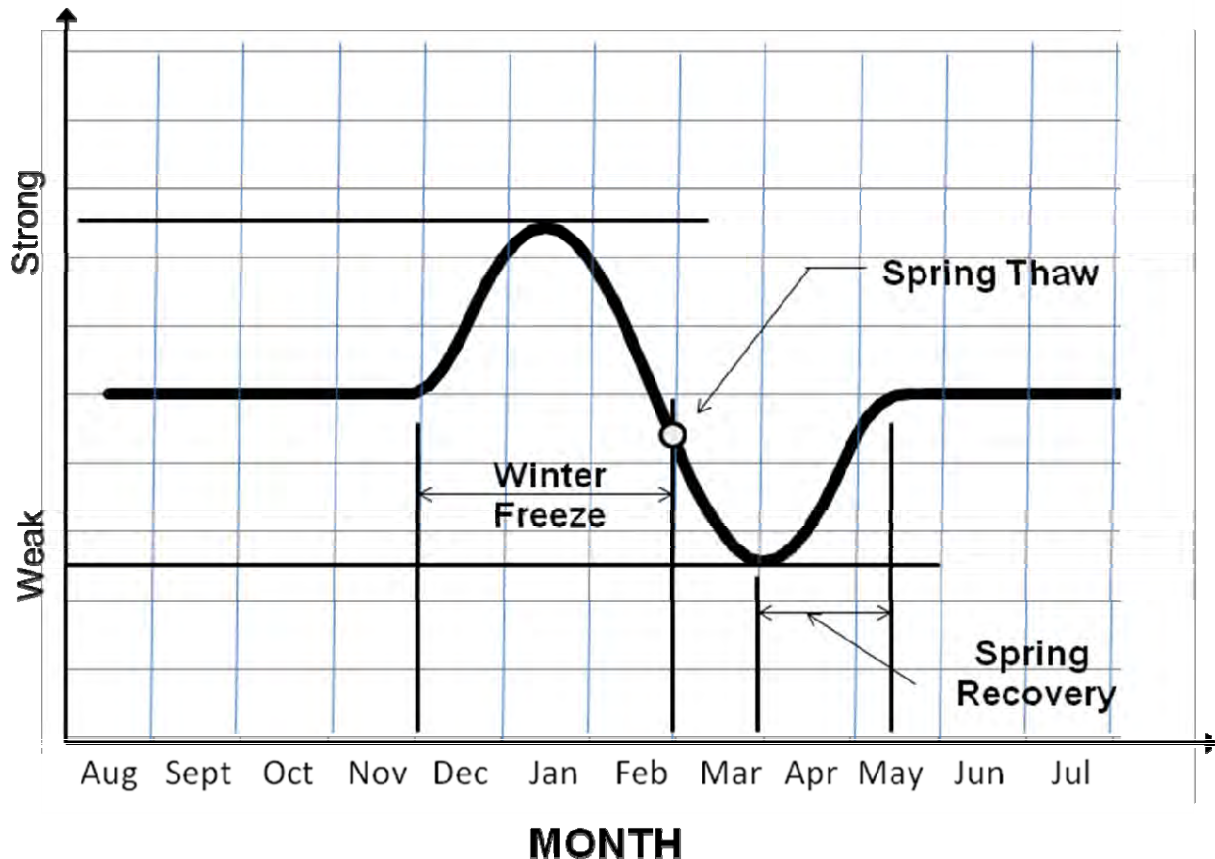

Figure A-5. Typical deflections illustrating seasonal pavement strength changes.
(on a portion of State Route 172 in Washington State).

The depth of frost penetration is a function of the soil's thermal properties of, surface temperature, and length of freezing season. The depth of frost penetration can be estimated by calculating the Freezing Index based on local weather data and using Figure 2-8 in AC 150/5420-6D. The Freezing Index is a combination of the duration and magnitude of below-freezing temperatures. The Freezing Index is calculated by multiplying the difference between the average temperature and 32 degrees by the duration of the freezing season. For example, assume an average daily temperature during a freezing period of 100 days is 20 degrees Fahrenheit; the Freezing Index is 1200 degree days (12 deg. X 100 days). The depth of frost penetration is used for the structural pavement design. The damaging effects of frost can be mitigated by the following techniques:

- Removal and replacement of frost-susceptible subgrade. The frost-susceptible subgrade can be removed to a depth equal to the depth of frost penetration.
- Limiting the depth of frost into the subgrade soils. The depth of the pavement structure is specified as a percentage (normally 65%) of the frost depth. By

extending the pavement section well into the frost depth, the depth of frost-susceptible subgrade under the pavement is reduced.

- Designing the pavement structure based on reduced subgrade support. Increase the pavement thickness to account for the loss of strength due to thaw weakening during the spring thaw.
- Load Restrictions – Reduce the allowable weight for aircraft using the runway during periods of spring thaw.

Maintenance options to correct these problems are limited to pavement repair or replacement (in the case of frost heave) or limiting pavement loading during spring thawing (in the case of thaw weakening).

More information concerning frost action can be found at:

http://pavementinteractive.org/index.php?title=Frost_Action

A.3.4 Drainage - Proper drainage is important to ensure a high quality pavement. Excessive moisture reduces the strength of the base, subbase and subgrade. In addition, moisture in some fine grained soils expand when causing differential heaving. Moisture in the HMA layers can also cause stripping – loss of adhesion of the binder to the aggregate.

Moisture sources are typically rainwater, runoff and high groundwater. These sources are prevented from entering the pavement structure or accumulating in the subgrade through surface drainage and subsurface drainage. It is more cost effective and less risky to prevent moisture entry and accumulation using surface drainage than to effect moisture removal using subsurface drainage.

Other sources of drainage information are:

<http://pavementinteractive.org/index.php?title=Drainage>

A.4 Pavement Design Procedures

AC 150/5320-6D presents two asphalt pavement design procedures – the Asphalt Institute Pavement Design Procedure and the Layered Elastic Design Procedure.

A.4.1 Asphalt Institute Method Pavement Design Procedure - Chapter 3 (design aircraft \geq to 30,000 pounds) of AC 150/5320-6D and Chapter 5 of AC 150/5320-6D (design aircraft less than 30,000 pounds) use the Asphalt Institute pavement design procedure. This design procedure relies on three elements to determine the thickness of the pavement structure: 1) the annual daily departures of the design aircraft, 2) subgrade strength as characterized by the CBR test, and 3) frost depth.

The design aircraft is the aircraft that requires the greatest pavement thickness. All other aircraft are converted to equivalent design aircraft based on aircraft weight and landing

gear type. (Sections 303 to 307 of AC 150/5320-6D describe the procedures for determining design aircraft and equivalent annual departures by design aircraft.)

The thickness of the pavement structure for a structural design life of 20 years is determined using Figures 3-2, 3-3, 3-4 or 5-2 in AC 150/5320-6D. The minimum thicknesses of the various pavement structural layers are summarized in Table A-1 (below). The thickness of the base course and subbase layers can be reduced if treated material (asphalt, cement, etc.) is used. The hot asphalt pavement (HAP) thickness in the noncritical areas can be reduced to 3 inches. The subgrade is compacted to a depth and density that appropriate to the design aircraft. Table 3-1 of AC 150/5320-6D summarizes the subgrade compaction requirement.

Table A-1. Summary of pavement structural layers. (AC 150/5320-6D)

Design Aircraft (lbs.)	Gears	Thickness (in)			
		HAP	Base Course	Subbase	Frost Protection Layer
Less than 30,000		2"	3" – 6" depending on design aircraft	Depending on CBR of Subgrade	Depending Frost Penetration Depth
30,000 – 50,000	SW	4"	4"		
50,000 – 75,000	SW	4"	6"		
50,000 – 100,000	DW	4"	6"		
100,000 – 200,000	DW	4"	8"		
100,000 – 250,000	DT	4"	6"		

A.4.1 Layered Elastic Pavement Design Procedure – This procedure was added to AC 150/5320-6D as part of Chapter 7 of Change 3, dated 4/30/04. This procedure can be used in place of the Asphalt Institute Procedure presented above (or see AC 150/5320-6D) for design aircraft of 30,000 pounds or more.

The pavement thickness and thickness of the various structural layers are determined using the LEDFAA (Layered Elastic Design Federal Aviation Administration) computer program. This pavement design procedure is based on: 1) number of total aircraft operations; 2) weight of all the aircraft operating on the runway and 3) strength of the various structural layers based on modulus. More detailed information on this design procedure is located at:

http://www.faa.gov/airports_airtraffic/airports/resources/advisory_circulars/media/150-5320-6D/150_5320_6d_chg3.pdf

Appendix B

APHALT MIX DESIGN

B.1 Asphalt Mix Types

There are generally three different types of hot mix asphalt (HMA) pavements: surface course, binder (or medium) course, and asphalt-treated base (ATB) course.

- The surface course is the top pavement surface and is designed to be stable enough to carry vehicle loads and durable enough to withstand the environmental effects of air, water and temperature changes. The surface course is the only pavement layer at some General Aviation airports with a single pavement layer. Surface courses generally have a maximum aggregate size of 3/8 to 3/4 inches; they also have higher asphalt binder content.
- The binder course, the intermediate pavement layer, generally has a maximum aggregate size of 3/4 to 1 3/4 inches and slightly lower asphalt binder content than the surface course.
- Asphalt-treated base courses are sometimes used instead of a granular base course. ATB generally has a maximum aggregate size of up to 3 inches. The asphalt binder has little exposure to climate factors and generally has a lower asphalt binder content due to the larger aggregate size.

B.2 Aggregate

Aggregate is the coarse material component that provides strength to hot mix asphalt (HMA). This material includes gravel, crushed stone sand, silt and mineral filler. In general, the aggregates make up 95% to 96% of the HMA and approximately 30% to 50% of its cost.

FAA and CALTRANS use different terminology for defining the different size components of the aggregates:

- Coarse Aggregate - Both FAA and CALTRANS define coarse aggregate as the hard, durable rock retained on the #4 screen (at least .25 inches in size).
- Fine Aggregate (Fines) - FAA defines fine aggregate as the material that passes the #4 screen (smaller than .25 inches) and is retained on the #200 screen (approximately .005 inches in size). CALTRANS defines fine aggregate as the material that passes the #4 screen.
- Mineral Filler – FAA defines mineral filler as the material that passes the #200 screen (clay, smaller than .005 inches). CALTRANS does not define mineral filler at all.

- Supplemental fines – FAA does not define supplemental fines. CALTRANS defines supplemental fines as material passing the #30 screen (fine sand and silt/clay) that is added to the mix and includes hydrated lime, Portland cement, and fines collected from dust collectors.

B.2.1 Chemical Properties – The suitability of the aggregate for hot mix asphalt depends on both chemical and physical properties of the aggregates. The key chemical properties of the aggregates that affect HMA performance are:

- Solubility – Some aggregates are water soluble and will degrade when exposed to water.
- Affinity for asphalt – Some aggregates do not bond well with asphalt binder. This phenomena, commonly called *stripping*, results in premature raveling. Laboratory test CT 371 *Resistance of Compacted Bituminous Mixture to Moisture Induced Damage* and ASTM D 4867 *Effects of Moisture on Asphalt Concrete Paving Mixtures* tests the affinity of the aggregate to bond with the asphalt binder. Lime or antistrip additive can be added to the asphalt mix to improve the bonding characteristics of the aggregate and asphalt binder.

B.2.2 Physical Properties - The key physical properties of the aggregate that effect the performance of hot mix asphalt pavement are:

- **Aggregate Size** – The aggregate size affects HMA strength and stability. Hot mix asphalts with a larger-size aggregate are generally stronger and more stable. However, excessive large aggregate may result in segregation and poor workability. Mixes with a smaller aggregate size are generally more durable because they have a higher asphalt binder content.
- **Gradation** – The aggregate gradation determines the mixture characteristic and the physical properties of the HMA. The aggregate’s particle size distribution (gradation) affects the stiffness, stability, durability, permeability, workability, fatigue resistance, frictional resistance and resistance to moisture damage. The gradation is determined separating the aggregate through a series of sieves with progressively smaller openings. Particle size distribution is determined as a percent retained by weight on each sieve. FAA uses ASTM C 136 Sieve Analysis of Fine and Coarse Aggregates and CALTRANS uses CT 202 *Sieve Analysis of Fine and Coarse Aggregate* laboratory tests to determine aggregate gradation.

These results are plotted on a .45 power gradation chart (Figure B-1). The aggregate gradation that has the maximum density is represented by the maximum density line that is plotted from the origin to the maximum aggregate size. The space between the aggregate gradation and the maximum density line represents the volume of the asphalt mix that is available for asphalt binder and air voids.

Aggregate gradations that are commonly referred to:

- Dense (well-graded) – Aggregate gradation that is near the maximum density line. This is the most common type of HMA. However, aggregate gradations that fall on the maximum density line should be avoided

because there is no room to accommodate the asphalt binder and air voids necessary for good pavement performance.

- Fine gradation – Dense-graded aggregate gradation that is above the maximum density line.
- Coarse gradation – Dense-graded aggregate gradation that is below the maximum density line.
- Gap graded – Aggregate gradation that contains only a small percentage of particles in the mid-size range. These HMAs are prone to segregation.
- Open graded – Aggregate gradation that contains only a small portion of aggregate particles in the small sieve range. This HMA has more air voids and is more porous.
- Uniformly graded – Aggregate gradation where most particles are the same size.

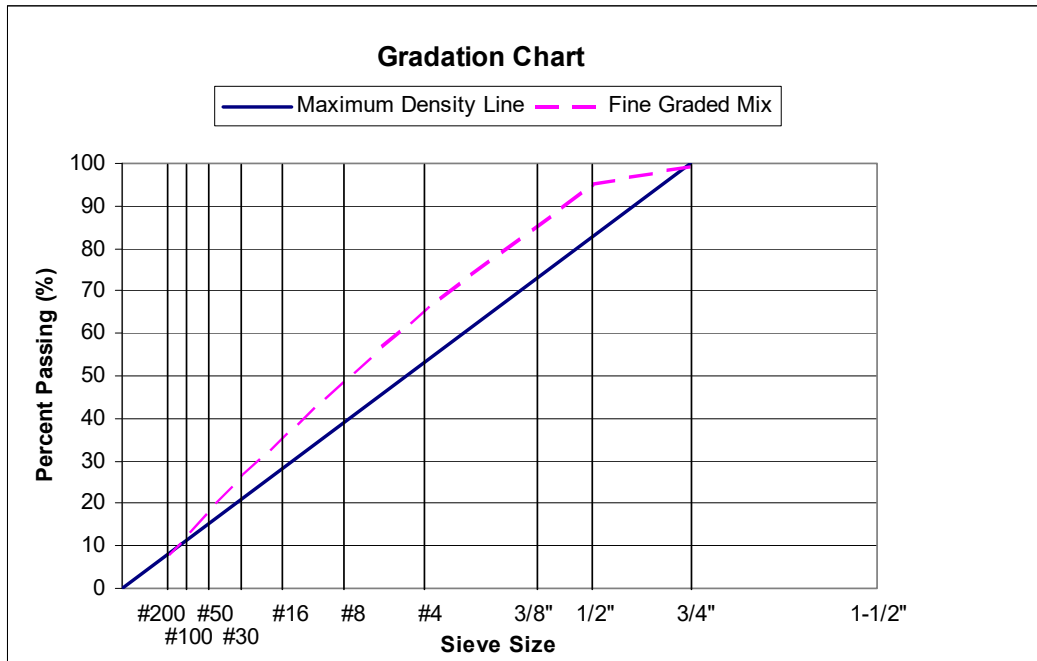

Figure B-1. Gradation chart of fine graded asphalt mix and maximum density line.

The aggregate gradation specification bands are defined by the maximum aggregate size. There are two different ways to define the maximum aggregate size:

- Maximum Size – FAA uses “maximum size” aggregate (smallest sieve through which 100 percent of the aggregate particles pass) to define the aggregate gradation band.
- Maximum Nominal Size – CALTRANS uses the term “maximum nominal size” (one sieve larger than the first sieve to retain more than 10% of the material to pass) to define the aggregate gradation band.

It is important to specify whether “maximum size” or “nominal maximum size” is used to define the aggregate gradation band. For example, the

FAA 3/4 ” gradation band is more similar to the CALTRANS 1/2” gradation band than the CALTRANS 3/4 gradation band.

Another source of information on asphalt mix aggregate gradation can be found at

http://pavementinteractive.org/index.php?title=Gradation_and_Size

- **Particle shape and surface texture** – Aggregate particles should be cubical or angular shaped rather than flat or elongated. This shape provides more interlock and internal friction in generating higher deformation (rutting) resistance. The surface texture and the shape affect the workability in mixes and may affect compaction. A rough fractured particle has a higher surface area and forms tougher adhesive bonds. Surface texture is determined in the laboratory test CT 205 *Determining Percentage of Crushed Particles* by measuring the percentage of coarse particles that have a single face or double face fracture.

In addition, flat and elongated particles have a tendency to break during mixing and construction. FAA and CALTRANS also uses ASTM 4791 *Flat Particles, Elongate Particles, or Flat and Elongate Particles in Coarse Aggregate* to determine the percentage of coarse material that has a ratio of the longest dimension to the smallest dimension of at least 5:1.

Another source of information for particle shape and texture of aggregates is: http://pavementinteractive.org/index.php?title=Particle_Shape_and_SurfaceTexture

- **Cleanliness (Presence of Deleterious Material)** – Aggregates must be clean to adhere to the asphalt binder. Vegetation, soft particles, clay lumps, excess dust and vegetable matter may degrade and leave pockmarks in the pavement. FAA uses ASTM D 2419 *Sand Equivalent Value of Soils and Fine Aggregate* and CALTRANS uses CT 217 *Sand Equivalent* laboratory tests to measure this property of the HMA aggregates.
- **Hardness (Abrasion Resistance)** – Aggregates transmit the wheel loads to the subgrade. Aggregates should be hard and tough enough to resist crushing, degradation and disintegration during the manufacturing, stockpiling, production, placing and compaction processes. FAA uses ASTM C-131 *Resistance to Degradation of Small Size Coarse Aggregate by Abrasion and Impact in the Los Angeles Abrasion Machine* and CALTRANS uses CT 211 *Abrasion of Coarse Aggregate by Use of the Los Angeles Rattler Machine* laboratory tests to measure this property.
- **Durability (Soundness)** – Aggregates must be resistant to breakdown and disintegration from weathering (wetting/drying and freezing/thawing), or they may break apart and cause premature pavement distress. FAA uses ASTM C 88 *Soundness of Aggregates by Use of Sodium Sulfate or Magnesium Sulfate* and CALTRANS uses CT214 *Soundness of Aggregates by use of Sodium Sulfate* laboratory tests to measure this characteristic.

Another source of information on aggregate durability is at:

http://pavementinteractive.org/index.php?title=Durability_and_Soundness

- **Absorption** – Aggregates may absorb some of the asphalt binder, reducing the effective amount of asphalt binder in the HMA. The asphalt binder content must be adjusted to account for the asphalt binder absorbed by the aggregate. If the content is not adjusted to accommodate the amount of binder absorbed by the aggregate, the pavement will ravel. FAA uses ASTM C 127 *Specific Gravity and Absorption of Coarse Aggregate* and CALTRANS uses CT 303 *Centrifuge Kerosene Equivalent and the Oil Ratio* laboratory tests to measure the absorption of aggregate.
- **Specific Gravity** – Specific gravity is the ratio of the aggregate to water. The aggregate specific gravity is used in making weight-volume conversions and in calculating the void content in compacted HMA.

Other sources of general information on aggregates are located at:

- Pavement Interactive Website
<http://pavementinteractive.org/index.php?title=Aggregate>
- WSDOT Pavement Guide <http://training.ce.washington.edu/wsdot/>

B.3 Asphalt Binder

The term “asphalt binder” refers to the binding agent that glues the aggregate together in a hot mix asphalt (HMA). This includes asphalt cement and any modifiers added to the asphalt cement.

The key performance characteristics that affect asphalt performance are:

- Stiffness of the asphalt at high service temperatures to resist pavement rutting and shoving,
- Elasticity of the asphalt at low service temperatures to resist thermal cracking, and
- Flexibility of the asphalt between the low and high service temperatures to minimize fatigue (alligator) cracking.

The most important physical properties of asphalt binders that affect pavement performance are:

- Durability, a measure of how asphalt binder physical properties change with age (age hardening). In general, as an asphalt binder ages, its viscosity increases and it becomes more stiff and brittle.
- Rheology, the deformation and flow properties of the asphalt cement. Pavements that deform and flow too much may be susceptible to rutting and bleeding, while those that are too stiff may be more susceptible to fatigue cracking

B.3.1 Asphalt Cement - Asphalt cement, also known as bitumen, or bituminous material, is a dark brown to black, highly viscous, hydrocarbon produced primarily from petroleum distillation. This distillation process can occur either naturally, resulting in asphalt lakes, or it can be performed through the petroleum refining process. The asphalt functions as a waterproof, thermoplastic, viscoelastic adhesive that holds the aggregates together. By weight, asphalt generally accounts for between 4 and 8 percent of the HMA and makes up about 25 to 30 percent of the cost of an HMA pavement.

Asphalt cement is a combination many different types of bitumen, resins, absorbed gas, oils and other ingredients. The relative amounts of the various ingredients in asphalt cement primarily depend on the initial crude source and the distillation or refining process. These various ingredients react differently over time, resulting in changes to the chemical and physical properties of asphalt cement. In general, as the asphalt cement ages, it becomes stiffer, less elastic and less flexible. The key factors affecting the age-hardening of asphalt cement are:

- Oxidation – Reaction of oxygen with the asphalt cement.
- Volatization – Evaporation of some of the absorbed gases in the asphalt cement.
- Polymerization – Combination of similar molecules to form larger molecules.
- Thixotrophy – Refers to the tendency of asphalt cement to “set up” when unagitated. This may caused suspended asphalt molecules to form a lattice structure. This is a factor in age hardening of asphalt pavements that are not constantly exposed to traffic loadings such as runway shoulders and safety areas.
- Syneresis - Separation of less viscous liquids from the more viscous asphalt molecules; it results in the rearrangement of the molecular structure of the asphalt cement.
- Separation – Absorption by porous aggregates of some of the components of the asphalt cement.

B.3.2 Asphalt Modifiers - Asphalt modifiers are sometimes added to asphalt cement to alter the chemical/physical properties and improve the following performance characteristics:

- Decreased stiffness at low service temperatures which reduces thermal cracking.
- Increased stiffness at high service temperatures which reduces rutting and shoving.
- Decreased stiffness at high temperatures which facilitates pumping of liquid asphalt and the mixing and compaction of the HMA.
- Increased adhesion between asphalt binder and aggregate which reduces stripping and raveling.

B.3.3 Asphalt Binder Grading Systems – The following grading systems have been used to classify asphalt binders:

- Penetration grading system – This grading system is based on the depth a standard needle will penetrate an asphalt binder sample when placed under a 100 g load for 5 seconds. The test is simple and easy to perform, but it does not

measure any fundamental parameter and can only characterize asphalt binder at one temperature (77°F). Penetration grades are listed as a range of penetration units (one penetration unit = 0.1 mm). This system was used prior to 1970 in California. The primary asphalt binders used in California were 60-70 and 85-100 grades.

- Viscosity grading system – This grading system is based on the asphalt binder's viscosity at 140°F and 275°F. Grades are listed in poises (cm-g-s = dyne-second/cm²) or poises divided by 10. Typical asphalt binders used in the U.S. are AC-5 AC-10, AC-20 AC-30 and AC-40. Viscosity grading is a better grading system, but it does not test low temperature asphalt binder rheology or performance. This grading system is used by FAA but not by CALTRANS.
- Aged Residue (AR) grading system – This system is similar to the Viscosity Grading system with the exception that it is based on viscosity of the asphalt after it had been “aged” in the laboratory using the rolling thin film oven test (RTFO). The RTFO test simulates the aging process that the asphalt binder is exposed to during the asphalt mixing operation. This grading system has been replaced by CALTRANS in 2006 with the Superpave grading system.
- Performance Based Asphalt (PBA) grading system – A combination of penetration, ductility, viscosity and rheology tests were used to characterize the asphalt binder. Common PBA grades used in California are PBA-6a, PBA 6b, PBA 7 and PBA 6a*. This system was used by CALTRANS from the early 1990s until it was replaced by the Superpave system in 2006.
- Superpave (Performance Grade – PG) – The PG grading system was developed as part of the \$150 million Strategic Highway Research Program (SHARP) funded by FHWA. This grading system uses laboratory tests and specifications that characterize the rutting, fatigue cracking and thermal cracking performance properties of the asphalt binder. A key difference between the PG grading system and the other binder grading systems is that the PG grading system addresses asphalt binder performance at both high and low service temperatures. The other grading systems only measured the physical properties at high service temperatures.

The PG grading system tests the asphalt binder at loading times, temperatures and aging conditions that more realistically predict the conditions to which the pavement might be exposed. The PG binder specifications help identify binder grades that that will minimize low temperature cracking, fatigue cracking and rutting within the climatic range and traffic loadings of the asphalt pavement.

The PG grading system is reported using two numbers. The first number is the average seven day maximum pavement temperatures (deg. C) and the second number is the coldest pavement temperature (deg. C) that it will experience. For example, a PG 64-28 is to be used where the average seven day maximum pavement temperature is below 64 degrees C and the coldest pavement temperature is warmer than -10 degrees C. This binder will provide:

- Enough stiffness at a pavement temperature of 147°F (64°C) to resist permanent deformation and rutting.
- Enough elasticity at a pavement temperature of -18°F (-28°C) to resist thermal cracking.
- Enough flexibility between temperatures of 147°F (64°C) and -18°F (-28°C) to minimize fatigue cracking.

The primary laboratory tests used in the PG grading system are:

- Rolling Thin Film Oven Test – This test prepares the binder sample for the Dynamic Shear Rheometer Test by simulating the short term aging process that the binder will experience during the mixing process.
- Pressure Aging Vessel Test – This test prepares the binder sample for the Direct Tension, Bending Beam Rheometer and Dynamic Shear Rheometer tests by simulating the long-term aging process that the binder will experience during the design life of the pavement.
- Rotational (Brookfield) Viscometer – This test measures the high temperature viscosity of the binder to simulate the pumpability and workability of the asphalt binder at mixing and laydown temperatures. This test involves rotating a cylindrical spindle in the asphalt binder at 135°C (this is a test specific temperature). Dynamic Shear Rheometer (DSR) – The test characterizes the viscous and elastic behavior of asphalt binders at medium to high temperatures. This test involves placing a thin binder sample between two plates. The top plate oscillates to create a shearing action that simulates the shearing action caused by vehicle loading.
- Bending Beam Rheometer (BBR) – This test is used to test the thermal cracking characteristics of the asphalt binder at cold temperatures. The BBR test applies a point load to a beam composed of the asphalt binder.
- Direct Tension Tester (DTR) – This test is used to characterize the thermal cracking properties of the asphalt binder at cold temperatures. The DTR test applies a load in tension on a small sample until it breaks. It is only used on stiff asphalt binders where the creep stiffness exceeds 300 MPa.

Figure B-2 shows the recommended PG binders for California. Other sources of information on the PG grading system are available at:

http://pavementinteractive.org/index.php?title=Superpave_Performance_Grading.

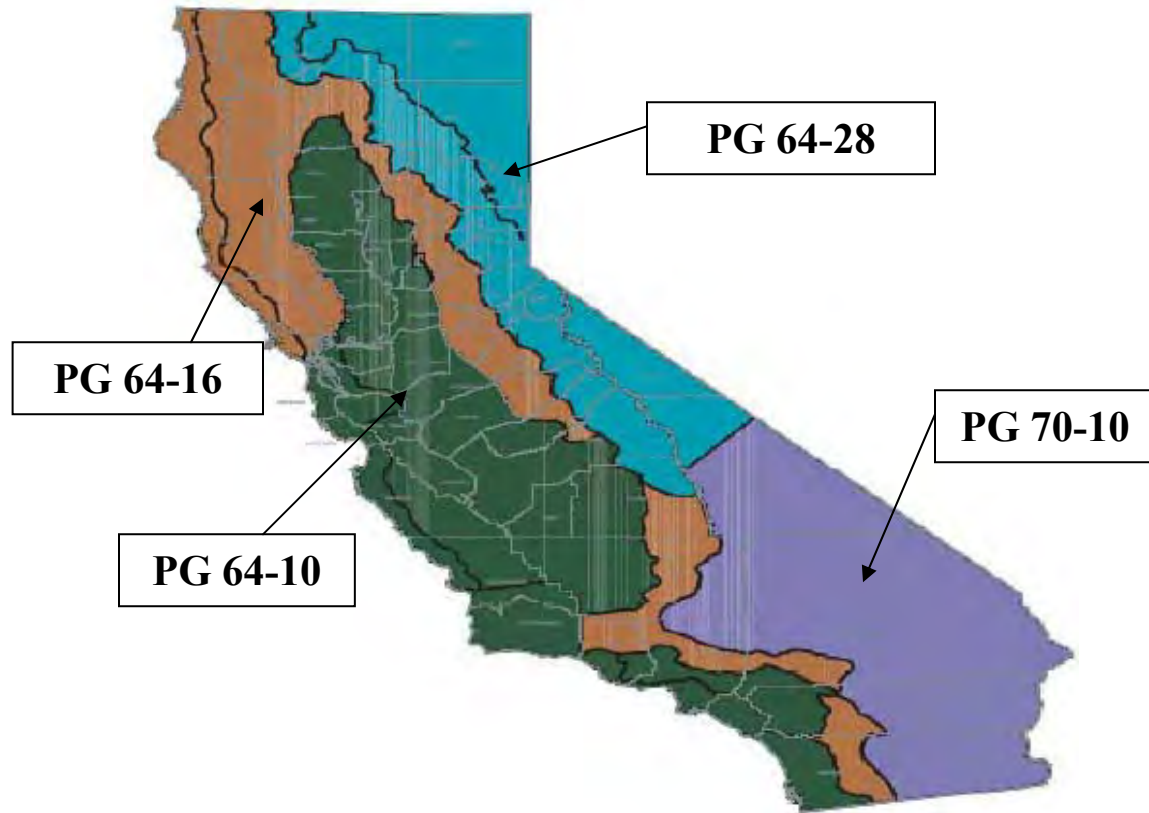

Figure B-2. Asphalt binders recommended by CALTRANS.

Other sources of general information on asphalt binders are:

- Pavement Interactive website for asphalt <http://pavementinteractive.org/index.php?title=Asphalt>
- WSDOT Pavement Guide <http://training.ce.washington.edu/wsdot/>

B.4 Asphalt Mix Design

Asphalt mix design is the result of series of laboratory tests that determine the suitability and proportion of asphalt binder and aggregates necessary for a long-lasting hot mix asphalt pavement. These tests determine the appropriate combination of different sizes of aggregates and the amount of asphalt cement needed to produce a stable and durable hot mix asphalt pavement.

Key factors that affect asphalt mix design are:

- Aggregate – The aggregate provides the strength and stability to the Hot Mix Asphalt. The aggregate shape, gradation, surface texture, absorption characteristics, durability, hardness and cleanliness affect the performance of the hot mix asphalt.

- Asphalt Binder – The asphalt binder is the adhesive agent that glues the aggregate together. Viscosity, stiffness and deformation characteristics affect the performance of the hot mix asphalt.
- Optimum Asphalt Binder Content – The optimum asphalt binder content is the percentage of asphalt binder that balances the durability (considering weather and site conditions) and stability (considering aircraft loading) requirements for the asphalt pavement. In general, as the percentage of asphalt cement in the hot asphalt pavement increases, the more durable the pavement will be in withstanding the effects of weather, moisture and aging. However, as the percentage of asphalt binder increases, the less stable the asphalt mix will be under aircraft loading. (Fig. 3-3)
- Air Voids – The air voids in the asphalt mix must be sufficient to allow for the asphalt binder to expand during periods of warm temperatures without bleeding, flushing or loss of stability. However, the air voids must also be kept to a minimum to limit permeability and minimize the flow of air and water into the hot asphalt mix. In addition, minimal air voids help retard aging and moisture damage to the pavement.

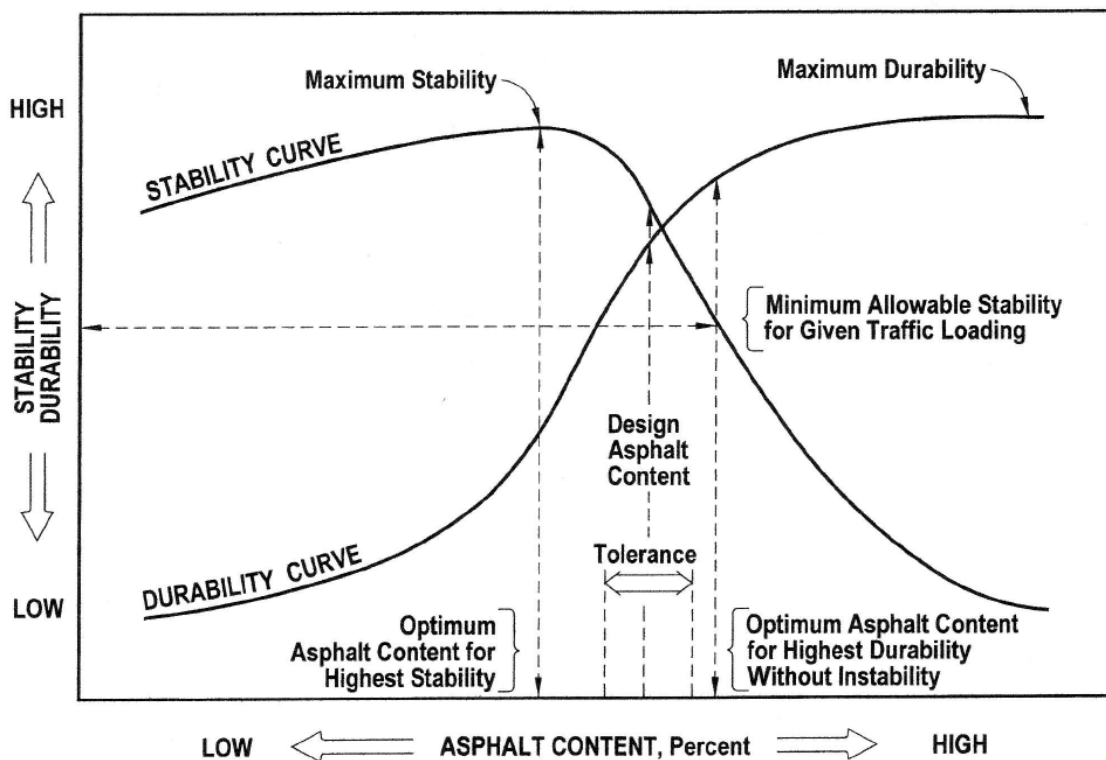

Figure B-3. Schematic of stability-durability relationship of hot mix asphalt.
(Hot-Mix Asphalt Pavement Handbook)

The key objectives for an acceptable asphalt mix design are:

- Stability – The hot mix asphalt (HMA) should not distort (rut) or deform (shove) under aircraft loading. This is primarily dependent on aggregate gradation, aggregate shape, asphalt binder content and type of asphalt binder.

- Fatigue – The HMA should not prematurely crack when subjected to repeated aircraft loads over time. This is primarily dependent on asphalt binder content and type of asphalt binder.
- Low temperature cracking – The HMA should not crack when subjected to cold temperatures. This is primarily dependent on the type of asphalt binder.
- Durability – Exposure to water and sun will age the asphalt pavement, ultimately causing it to become stiffer and crack. This is primarily dependent on asphalt binder content and air voids.
- Moisture Damage – The HMA should be resistant to moisture-induced damage. This is primarily dependent on air voids, chemical properties of the aggregate, and an appropriate anti-strip additive.
- Workability – The HMA should be mixed and placed without sacrificing stability or durability. This is primarily dependent on aggregate gradation and asphalt binder content.
- Skid Resistance – The HMA should provide sufficient skid resistance to permit safe aircraft operations. This is primarily dependent on aggregate toughness, size and gradation.

There are three different mix design methods – Marshall, Hveem and Superpave – currently used in the United States.

B.4.1 Marshall Mix Design – The Marshall mix design procedure is an empirical laboratory mix design test procedure developed by the Mississippi Highway Department in the late 1930s and modified by the U. S. Army to be used on airfields. Until recently, the Marshall mix design procedure was the most commonly used for state highway departments. FAA currently requires it for airports.

In summary, the Marshall mix design procedure requires that three specimens of asphalt mix be prepared at 4 to 5 different binder contents in half percent increments. The 2½” thick by 4” diameter specimens are prepared by compacting the mix with a specially designed mechanical compactor. For airport pavements with design aircraft weight less than 60,000 pounds, the specimens are compacted by 50 blows on each side. For airport pavements with design aircraft weight equal to or greater than 60,000 pounds, the specimens are compacted by 75 blows on each side.

A load is applied to the side of the specimen at a constant rate of deformation. The maximum load before failure is the Marshall stability (pounds) and the amount of deformation is the flow (hundredths of an inch). The unit weight, percent voids, voids filled, and voids in the mineral aggregate (VMA) for each specimen are calculated. A series of graphs are plotted of the unit weight, air voids, VMA, voids filled, Marshall stability, and flow vs. asphalt content. The asphalt mix design criteria for airports are listed in Table B-1. The optimum binder content is the binder content at 4% voids. Minor adjustments can be made to the optimum binder content to meet the Marshall mix design criteria.

Another source for detailed information on the Marshall mix design method is at the following website:

- Pavement Interactive website for asphalt
http://pavementinteractive.org/index.php?title=Marshall_Mix_Design

Table B-1. Summary of Marshall Mix Design Criteria

Aircraft Loads	Aircraft \leq 12,500 lbs.	Aircraft > 12,500 and < 60,000 lbs. or tire pressures < 100 psi		Aircraft \geq 60,000 lbs. or tire pressures \geq 100 psi	
Pavement Type	Surface Course	Surface Course	Binder & Base Course	Surface Course	Binder & Base Course
FAA Specification	P-403	P-401	P-403	P-401	P-403
Marshall Stability (Min. – (lbs.))	1000	1350	1000	2150	1800
Air Voids (%)	2% - 5%	2.8% - 4.2%	2% - 5%	2.8% - 4.2%	2% - 5%
Voids in Mineral Aggregate (VMA) (%min)	16 – ½” max. particle size 15- ¾” max. particle size	16 – ½” max. particle size 15- ¾” max. particle size	16 – ½” max. particle size 15- ¾” max. particle size	16 – ½” max. particle size 15- ¾” max. particle size	16 – ½” max. particle size 15- ¾” max. particle size
Flow (.01 in.)	10 - 18	8 - 20	10 - 18	10 - 14	8 - 16

B.4.2 Hveem Mix Design – The Hveem mix design procedure is an empirical laboratory mix design test procedure developed by CALTRANS. California is the only state that uses the Hveem mix design method. The twelve other state highway departments that used the Hveem mix design method for designing highway pavements in the past have have switched to either the Marshal or Superpave mix design procedure. The Hveem mix design procedure has not been used for any FAA-funded airport pavement projects, but it has been used on a few airport projects, funded by other sources, with design aircraft that do not exceed 12,500 pounds.

In summary, the steps for performing Hveem mix design procedure are:

- Determine the approximate optimum binder content by calculating the surface areas of the aggregate and the results of the Centrifuge Kerosene Equivalent (CFE) test.
- Prepare four specimens (2½” thick by 4” diameter) at four different asphalt contents – estimated optimum binder content; .5% and 1.0% above the optimum binder content and .5% below the optimum binder content.

- Compact the specimens using the California Kneading Compactor, which simulates the compactive effort by rollers during construction.
- Measure the Hveem stability using the Hveem Stabilometer. This applies a confining pressure to the sides of the specimen and a vertical load to the top of the sample.
- Plot a series of charts for the unit weight, percent air voids and Hveem stability vs. binder content.

The optimum binder content is the binder content at 4% voids if it meets the Hveem stability criteria.

Another source for detailed information on the Hveem mix design method is at the following website:

- Pavement Interactive Website for Asphalt
http://pavementinteractive.org/index.php?title=Hveem_Mix_Design

B.4.3 Superpave – The Superpave mix design method was developed as part of the \$150 million Strategic Highway Research Program (SHARP) funded by FHWA. Many state DOTs have adopted this procedure for highways. This mix design procedure has been used at some airports; it is currently being evaluated by the National Center for Asphalt Technology (NCAT) for use on airport pavements. CALTRANS is also evaluating the SUPERPAVE mix design procedure as a replacement for the Hveem mix design procedure.

In summary, the steps for performing the SUPERPAVE mix design procedure are:

- Select aggregate gradation based on aggregate gradation criteria.
- Prepare specimens (4.5” thick by 6” diameter) at different asphalt binder contents – above and below the estimated optimum binder content.
- Compact the samples using the Superpave gyratory compactor. This compactor simulates the compactive effort from construction rollers and vehicular traffic. The voids are measured at three different levels of compactive effort. The number of gyrations for each level of compactive effort depends on anticipated traffic levels during the design life of the pavement. The three levels of compactive effort are:
 - N(initial) – Number of gyrations used as a measure of mixture compactability during construction. Asphalt mixes that have less than 11% air voids may be tender during construction and unstable when subjected to traffic.
 - N(design) – Number of gyrations required to produce the same density based on the anticipated traffic loading during the design life of the pavement.
 - N(max) – Number of gyrations required to produce a density that will not be exceeded in the field. If the void content is less than 2%, the asphalt pavement may compact too much under traffic and may rut.

- Plot density vs. gyrations for each sample. The optimum binder content is determined as the binder content at N(design) gyrations at 4% voids. This optimum binder content must have a void content of 11% or greater at N(initial) and a void content of at least 2% at N(max) gyrations.

Another source of information on the Superpave mix design procedure is at the following website:

- Pavement Interactive website for asphalt
http://pavementinteractive.org/index.php?title=Superpave_Mix_Design

Appendix C

SUMMARY OF FAA ADVISORY CIRCULARS PERTAINING TO ASPHALT PAVEMENTS

AC 150/5300-13 - Airport Design –

http://www.faa.gov/airports_airtraffic/airports/resources/advisory_circulars/media/150-5300-13/150_5300_13.pdf) This circular contains the Federal Aviation Authority’s standards and recommendations for airport design. This circular includes airport geometry, runway design, taxiway & taxilane design, surface gradient & line of sight requirements, NAVID & ATC facility requirements, runway & taxiway bridges and effects & treatment of jet blast.

AC 150/5320-6D – Airport Pavement Design and Evaluation – This circular provides guidance for the design and evaluation of pavements at civil airports. This circular includes sections on soil investigations and evaluation; flexible pavement (asphalt) design; rigid pavement (concrete) design; pavement overlays and reconstruction; pavements for light aircraft and pavement evaluation.

Part 1

http://www.faa.gov/airports_airtraffic/airports/resources/advisory_circulars/media/150-5320-6D/150_5320_6d_part1.pdf

Part 2

http://www.faa.gov/airports_airtraffic/airports/resources/advisory_circulars/media/150-5320-6D/150_5320_6d_part2.pdf

Part 3

http://www.faa.gov/airports_airtraffic/airports/resources/advisory_circulars/media/150-5320-6D/150_5320_6d_part3.pdf

Part 4

http://www.faa.gov/airports_airtraffic/airports/resources/advisory_circulars/media/150-5320-6D/150_5320_6d_part4.pdf

Part 5

http://www.faa.gov/airports_airtraffic/airports/resources/advisory_circulars/media/150-5320-6D/150_5320_6d_part5.pdf

Change 1

http://www.faa.gov/airports_airtraffic/airports/resources/advisory_circulars/media/150-5320-6D/150_5320_6d_chg1.pdf

Change 2

http://www.faa.gov/airports_airtraffic/airports/resources/advisory_circulars/media/150-5320-6D/150_5320_6d_chg2.PDF

Change 3

http://www.faa.gov/airports_airtraffic/airports/resources/advisory_circulars/media/150-5320-6D/150_5320_6d_chg3.pdf

Change 4

http://www.faa.gov/airports_airtraffic/airports/resources/advisory_circulars/media/150-5320-6D/150_5320_6d_chg4.pdf

AC 150/5320-12C – Measurement, Construction, and Maintenance of Skid-Resistant Airport Pavement Surfaces – This circular contains guidelines and procedures for the design and construction of skid-resistant pavement, pavement evaluation with friction measuring equipment, and maintenance of high skid-resistant pavements.

http://www.faa.gov/airports_airtraffic/airports/resources/advisory_circulars/media/150-5320-12C/150_5320_12c.PDF

Change 1

http://www.faa.gov/airports_airtraffic/airports/resources/advisory_circulars/media/150-5320-12C/150_5320_12c_chg1.pdf

Change 7

http://www.faa.gov/airports_airtraffic/airports/resources/advisory_circulars/media/150-5320-12C/150_5320_12c_chg8.pdf

AC 150/5320-17 – Airfield Surface Evaluation and Rating Manual – This circular provides guidance on understanding and rating the surface condition of flexible and rigid airfield pavements. It describes the types and causes of distress and provides a simple system to visually rate pavement condition ranging from excellent to failure. This circular also includes PASAR pavement condition rating system.

http://www.faa.gov/airports_airtraffic/airports/resources/advisory_circulars/media/150-5320-17/150_5320_17_complete.pdf

AC 150/5335-5A - Standardized Method of Reporting Pavement Strength – PCN – This circular provides guidance for using the standardized International Civil Aviation Organization method to report pavement strength so airport managers can evaluate acceptable operations of airports. This method is used for pavements with bearing strengths of 122,500 pounds or greater and is known as the Aircraft Classification Number – Pavement Classification Number (ACN-PCN) method. The ACN is calculated for each type of aircraft and represents the effect of the airplane on the pavement structure. The PCN represents load capacity of the pavement. A pavement can support an aircraft with a ACN equal to or less than the PCN.

http://www.faa.gov/airports_airtraffic/airports/resources/advisory_circulars/media/150-5335-5A/150_5335_5a.pdf

AC 150/5340-1J – Standards for Airport Markings – This circular contains the FAA standards for markings used on airport runways, taxiways and aprons.

http://www.faa.gov/airports_airtraffic/airports/resources/advisory_circulars/media/150-5340-1J/150_5340_1j.pdf

AC 150/5370-2E – Operational Safety on Airports During Construction – This circular provides guidelines for operational safety during construction.

http://www.faa.gov/airports_airtraffic/airports/resources/advisory_circulars/media/150-5370-2E/150_5370_2e.pdf

AC 150/5370-6C – Construction Progress and Inspection Report – Airport Improvement Plan (AIP) – This circular provides guidance for reporting construction progress of projects under the Airport Improvement Plan (AIP). The circular also includes FAA Form 5370-1 *Construction Progress and Inspection Report*.

AC 150/5370-10C – Standards for Specifying Construction of Airports

http://www.faa.gov/airports_airtraffic/airports/resources/advisory_circulars/media/150-5370-10C/150_5370_10c.pdf

AC 150/5370-11A – Use of Nondestructive Testing in the Evaluation of Airport Pavements – This circular provides guidance on collecting and analyzing nondestructive tests. Nondestructive testing measures the surface deflection of the pavement surface after applying a static or dynamic load to the pavement surface.

http://www.faa.gov/airports_airtraffic/airports/resources/advisory_circulars/media/150-5370-11A/150_5370_11a.pdf

AC 150/5370-12A – Quality Control of Construction for Airport Grant Projects – This circular provides information to ensure the quality of construction accomplished under the FAA Airport Improvement Program.

http://www.faa.gov/airports_airtraffic/airports/resources/advisory_circulars/media/150-5370-12A/150_5370_12a.pdf

AC 150/5370-13A – Off-Peak Construction of Airport Pavements Using Hot-Mix Asphalt - This circular provides guidance for the planning, coordination, management, design, testing, inspection, and execution of off-peak construction of airport pavements using hot-mix asphalt pavements.

http://www.faa.gov/airports_airtraffic/airports/resources/advisory_circulars/media/150-5370-13A/150_5370_13a.pdf

AC 150/5370-14A – Hot Mix Asphalt Paving Handbook

http://www.faa.gov/airports_airtraffic/airports/resources/advisory_circulars/media/150-5370-14A/150_5370_14a.pdf

http://www.faa.gov/airports_airtraffic/airports/resources/advisory_circulars/media/150-5370-14A/150_5370_14a_app1_Introduction.pdf

http://www.faa.gov/airports_airtraffic/airports/resources/advisory_circulars/media/150-5370-14A/150_5370_14a_app1_part_I.pdf

http://www.faa.gov/airports_airtraffic/airports/resources/advisory_circulars/media/150-5370-14A/150_5370_14a_app1_part_II_a.pdf

http://www.faa.gov/airports_airtraffic/airports/resources/advisory_circulars/media/150-5370-14A/150_5370_14a_app1_part_II_b.pdf

http://www.faa.gov/airports_airtraffic/airports/resources/advisory_circulars/media/150-5370-14A/150_5370_14a_app1_part_II_c.pdf

http://www.faa.gov/airports_airtraffic/airports/resources/advisory_circulars/media/150-5370-14A/150_5370_14a_app1_part_III_a.pdf

http://www.faa.gov/airports_airtraffic/airports/resources/advisory_circulars/media/150-5370-14A/150_5370_14a_app1_part_III_b.pdf

http://www.faa.gov/airports_airtraffic/airports/resources/advisory_circulars/media/150-5370-14A/150_5370_14a_app1_glossary_bibliography.pdf

AC 150/5380-6B – Guidelines and Procedures for Maintenance of Airport Pavements -

This circular provides information on the types of pavement distress and provides corrective action.

http://www.faa.gov/airports_airtraffic/airports/resources/advisory_circulars/media/150-5380-6B/150_5380_6b.pdf

AC 150/5380-7A – Airport Pavement Management Program – This circular provides guidance on the Airport Pavement Management System (APMS) and how it can be used to make cost-effective decisions about pavement maintenance and rehabilitation.

http://www.faa.gov/airports_airtraffic/airports/resources/advisory_circulars/media/150-5380-7A/150_5380_7a.pdf

Appendix D DEFINITIONS

Adhesion – Bond between asphalt cement and aggregate. Adhesion is also is the bond between a sealant material and the crack or joint sidewall.

Aggregate – Mineral materials such as sand, gravel and crushed rock that are blended with asphalt binder to produce Hot Mix Asphalt (HMA).

Aggregate Interlock - Interaction of aggregates by which the fractured faces mesh and prevent both aggregates from moving.

Aircraft Classification Number (ACN) – Number that expresses the relative effect of an airplane at a given weight on a pavement structure for a specified standard subgrade strength. (AC 150/5335-5A)

Alligator Cracking – A series of interconnecting cracks in an asphalt pavement surface that forms a pattern resembling an alligator’s hide or chicken wire. The cracks indicate fatigue failure of the hot mix asphalt generally caused by repeated traffic loadings. In its early stages, alligator cracking may be characterized by a single longitudinal crack in the wheel path.

Asphalt Binder – The principal asphalt binding agent in hot mix asphalt; it includes asphalt cement and modifiers.

Asphalt Cement – Dark brown to black material usually produced from the refining of crude oil; also referred to as bituminous material.

Asphalt Concrete – See Hot Mix Asphalt (HMA) concrete.

Asphalt Tack Coat (or paint binder) – A light application of asphalt, usually asphalt emulsion to ensure a bond between two bituminous pavement layers, or a bituminous layer placed over an existing Portland cement concrete layer.

Base (pavement course) – Base courses consist of a variety of different materials which generally fall into two main classes, treated and untreated. The untreated bases consist of crushed or uncrushed aggregates. The treated bases normally consist of a crushed or uncrushed aggregate that has been mixed with a stabilizer such as cement, bitumen, etc. (AC 150/5320-6D)

Base Course – The portion of the pavement surface below the surface course; it provides the primary structural support for the asphalt pavement. Base course usually consists of crushed aggregates that may be treated with asphalt or cement.

Batch Plant – A type of HMA plant that mixes the aggregates and asphalt binder in batches at high temperatures to produce a homogenous asphalt mix.

Bituminous Pavement – See Hot Mix Asphalt (HMA).

Bleeding – Movement of binder through the bituminous pavement to create a thin film of binder on the surface. The bleeding creates a shiny black surface that may be tacky to the touch, especially at high temperatures.

Block Cracking – A rectangular pattern of cracking in asphalt pavements often caused by asphalt binder hardening due to aging coupled with shrinkage due to thermal contraction of the asphalt mixture. Block cracking typically occurs at a uniformly spaced interval in pavements with low traffic volumes – runway shoulders and aprons.

Break – The process by which the globules of asphalt in an asphalt emulsion separate from the water. The color of the emulsion will change from brown to black during the breaking process.

California Bearing Ratio (CBR) – Laboratory test that measures the strength of subgrade material. The California Bearing Ratio (CBR) test is a simple strength test that compares the bearing capacity of a material with that of a well-graded crushed stone. A high quality crushed stone material should have a CBR of 100%. The CBR is primarily intended for, but not limited to, evaluating the strength of clay materials. The basic CBR test involves applying load to a small penetration piston.

California Profilograph – A rolling straight edge used for evaluating pavement profile (smoothness) consisting of a 7.5m (25-ft) frame with a wheel located at the center of the frame that senses and records bumps and dips on graph paper or by a computer.

Chip Seal – A surface treatment in which the pavement is sprayed with asphalt (generally emulsified asphalt) and then immediately covered with aggregate and rolled.

Coal-Tar Sealer - Coal-tar-based product designed to coat the surface and protect the pavement against fuel spill damage and the intrusion of air and water. It is cold applied and should be periodically reapplied and maintained. Coal-tar sealers may contain fine aggregates to enhance traction.

Cohesion – The internal strength of any material.

Cold Applied Sealant – A crack-sealing compound generally applied at ambient temperatures; the sealant reaches its final properties through a curing process.

Cold In-Place Recycling (CIR) – A process in which a portion of an existing asphalt pavement is pulverized or milled. The reclaimed material is mixed with rejuvenation oils or emulsions and aggregates, if needed, to ensure correct aggregate gradation.

- Cold Milling** – A process of removing pavement material from the surface of the pavement to prepare the surface to receive overlays and restore pavement cross slopes and profile.
- Corrective Maintenance** – Maintenance performed once a distress becomes severe enough to cause pavement disintegration, excessive deformation or cracking.
- Crack** – Fissure or discontinuity of the pavement surface.
- Crack Filling** – The placement of materials into non-working cracks to substantially reduce the intrusion of incompressible material and infiltration of water.
- Crack Sealing** – The placement of specialized materials into working (active) cracks to prevent water infiltration into the underlying pavement layers. This specialized material allows the crack to remain sealed, even as it opens and closes during temperature fluctuations.
- Dense Graded Asphalt Pavement** – An overlay or surface course consisting of a mixture of asphalt binder and a well graded aggregate. A well-graded aggregate is uniformly distributed throughout a full range of sieve sizes.
- Design Life** – The expected life of a pavement from the time that it is opened until structural rehabilitation is needed. The typical reporting of pavement life does not include the life of the pavement with the application of preventive maintenance.
- Drum Plant** - A type of HMA plant that mixes the aggregates and asphalt binder in a continuous process at high temperatures to produce a homogenous asphalt mix.
- Emulsified Asphalt** – A dispersion of asphalt binder, water, and emulsifying agent. Spherical globules of asphalt 0.5-10 microns in diameter are dispersed in water by using an emulsifying agent. These asphalt globules are either anionic (negatively charged) or cationic (positively charged).
- Falling Weight Deflectometer (FWD)** – Device that delivers an impulse load to the pavement surface and measures the resultant deflection. These results characterize the properties of the underlying soil layers.
- Fatigue Cracking** – See Alligator Cracking.
- Foreign Object Debris (FOD)** – Loose material on the pavement surface.
- Fog Seal** – A light application of slow setting asphalt emulsion diluted with water used to rejuvenate the surface of a HMA pavement.
- Fuel Resistant Sealant** – A joint or crack sealant compound resistant to fuel or other petroleum products; it is applied to protect pavements.

Full-Depth Patching – Removal and replacement of a segment of pavement to the level of the subgrade to restore areas of deterioration in either flexible or rigid pavements.

Grooving – The process used to cut slots into a pavement surface to provide channels for water to escape beneath tires, improving wet pavement skid resistance and reducing the potential for hydroplaning.

Hot Air Lance – A device that uses heated compressed air to clean, dry, and heat cracks in asphalt pavements prior to sealing.

Hot Applied Sealant – A crack or joint sealing compound applied in a molten state; it cures primarily by cooling to ambient temperature.

Hot Mix Asphalt (HMA) – HMA is a blend of asphalt binder and well-graded, high-quality aggregates. The materials are mixed in a plant and placed and compacted while hot. HMA is used for constructing new airfield pavement and patching and overlay of existing airfield pavements.

International Roughness Index (IRI) – A measure of a pavement’s longitudinal surface profile as measured in the wheel path by a vehicle traveling at typical operating speeds. The IRI is expressed in units of meters per kilometer or inches per mile and is an indication of pavement roughness.

Joint – A pavement discontinuity made by interruption of a paving operation.

Large Airplane – An airplane of that has maximum takeoff weight greater than 12,500 pounds.

Liquid Asphalt (cutback) – Asphalt cement liquefied by blending with petroleum solvents.

Longitudinal Crack – A crack or discontinuity in a pavement that runs generally parallel to the pavement centerline. Longitudinal cracks may occur as a result of poorly constructed paving lane joints, thermal shrinkage, inadequate support, and reflection from underlying layers. Longitudinal cracking that occurs in the wheel path is generally indicative of the early stages of fatigue cracking.

Longitudinal Joint – A constructed joint in a pavement layer that is oriented parallel to the pavement centerline.

Macrotexture – Visible roughness that provides paths for water to escape from beneath aircraft tires. (AC 150/5320-12C)

Microtexture – Fine scale roughness (may not be visible but is apparent to the touch) contributed by small individual aggregate particles on the pavement surface – i.e. like fine sand paper. Microtexture provides frictional resistance for aircraft operating at slow speeds. (AC 150/5320-12C)

Mineral Filler – Mineral product with at least 70% passing the 0.075 mm (No. 200 sieve). Commonly used mineral fillers include limestone dust, hydrated lime, Portland cement, and fly ash.

Nondestructive Testing (NDT) – Pavement testing that measures the surface deflection after applying a static or dynamic load to the pavement.

Nonworking Crack – Crack in asphalt pavement that does not change in width during seasonal temperature fluctuations.

Optimum Moisture Content – The moisture content at which maximum density can be achieved in a soil or aggregate material.

Overbanding – Overfilling of a joint or crack reservoir so that a thin layer of crack or joint sealant is spread onto the pavement surface center over the joint or crack.

Patch – Placement of a repair material to replace a localized defect in a pavement surface.

Pavement Classification Number (PCN) – Number that expresses the load carrying capacity of the pavement for unrestricted operations. (AC 150/5335-5A)

Pavement Condition Index (PCI) – Numerical index between 0 and 100 based on a visual survey to indicate the condition of the pavement. An index of 100 represents an excellent pavement.

Pavement Distress – Visible indications of pavement defects or deterioration.

Pavement preservation – The activities performed to provide, maintain and extend the life of airport pavements. This includes corrective, routine and preventive maintenance to keep the roadway in a safe and usable condition and delay the need for rehabilitation.

Pavement Reconstruction – Replacement of an existing pavement structure by the placement of the equivalent of a new pavement structure. Reconstruction usually involves complete removal and replacement of the existing pavement structure and may include new and/or recycled materials.

Pavement Rehabilitation – Structural enhancements that extend the service life of an existing pavement and/or improve its load carrying capability. Rehabilitation techniques include restoration treatments and structural overlays.

Plant Mix – See Hot Mix Asphalt.

Polishing – Wearing away of the surface binder, causing exposure of the coarse aggregate particles. A polished pavement surface is smooth and has reduced skid resistance.

Portland Cement Concrete (PCC) Pavement – A pavement constructed of Portland cement concrete with or without reinforcement.

Porous Friction Course (PFC) – Open graded, thin hot-mix asphalt surface course.

This course permits water to permeate through the course and drain off transversely to the side of the runway, preventing water buildup on the surface and creating a relatively dry pavement condition during rainfall. (AC 150/5320-12C)

Potholes – Potholes are typically bowl shaped holes in the pavement. Loss of HMA surface fines and matrix leads to a reduction in the integrity of the top pavement layer and formation of a hole.

Preventive Maintenance - A planned treatment on a pavement in good condition that is intended to preserve the pavement, retard future deterioration, prolong service life and delay the need for rehabilitation. This includes chip seals and thin overlays.

Prime Coat - Emulsified or cutback asphalt applied to an aggregate base course to: 1) waterproof the surface of the base; 2) plug capillary voids; and 3) promote adhesion between the base and the surface course

Pumping – Ejection of fine-grained material and water from beneath the pavement through joints, cracks, or the pavement edge, caused by the deflection of the pavement under traffic loadings.

Raveling – Aggregate loss from the pavement surface.

Reactive Maintenance – Pavement repair activities, such as pothole repairs, performed to correct random or isolated localized pavement distresses or failures.

Reflection Cracking – Cracking that appears on the surface of a pavement above joints and cracks in the underlying pavement layer due to horizontal and vertical movement at these joints and cracks.

Rejuvenating Agent – Products which are applied to existing aged or oxidized HMA pavements to restore pavement surface flexibility and to retard cracking.

Rheology – Deformation and flow characteristics of material under the influence of applied stress.

Router – A mechanical device, with a rotary cutting system, that is used to widen, cut, and clean cracks in pavements prior to sealing.

Routine Maintenance – Maintenance work that is planned and performed on a regular basis to maintain and preserve the condition of the pavement. Examples include crack sealing, fog sealing, and repair of localized failed areas of pavement.

Rubberized Asphalt Concrete (RAC) – Similar to HMA but having a minimum 15% crumb rubber additive in the binder.

Rubberized Asphalt Sealant – A sealant, generally hot applied, that is composed of asphalt cement, various types of rubber or polymer modifiers, and other compounding ingredients used for pavement crack and joint sealing.

Rutting – Longitudinal surface depressions in the wheel path of an HMA pavement caused by cumulative plastic deformation of the HMA mix or inadequate compaction.

Sealant – A material that has adhesive and cohesive properties to seal joints or cracks [generally less than 76 mm (3 in) in width].

Segregation – Separation of aggregate components present in asphalt mixes by particle size.

Shoving – Localized displacement of an HMA pavement surface, often caused by high shear stresses associated with vehicle acceleration to deceleration.

Skid Resistance – An indication of the frictional characteristics of a pavement surface.

Slippage Cracking - Cracking associated with the horizontal displacement of a localized area of an HMA pavement surface mainly due to a poor bond between layers of bituminous pavement.

Slurry – Dispersion of solid materials in a water carrier that forms a smooth and evenly distributed mixture.

Slurry Seal – Slurry seal is most commonly made with a quick setting emulsion in California (CQS-1h or LMCQS-1h), well graded fine aggregate, mineral filler, and water. It is used to fill fine non-working cracks and seal areas of old or raveling pavements, to restore a uniform surface texture, to seal the surface to prevent moisture and air intrusion into the pavement, and to improve skid resistance.

Small Airplane – An airplane of that has maximum takeoff weight less than or equal to 12,500 pounds.

Structural Condition – The condition of a pavement as it pertains to its ability to support the anticipated loadings.

Structural Overlay – An increase in the pavement load carrying capacity by adding additional pavement layers.

Subbase (pavement course) – Subbase courses consist of a granular material, a stabilized granular material, or a stabilized soil. (AC 150/5320-6D)

Surface (pavement course) – Surface courses include Portland cement, hot mix asphalt, sand-bituminous mixture and sprayed bituminous surface treatments. (AC 150/5320-6D)

Surface Texture – The microscopic and macroscopic characteristics of the pavement surface that contribute to surface friction and noise.

Swell - A hump in the pavement surface that may occur over a small area or as a longer, gradual wave; either type of swell can be accompanied by surface cracking.

Tack Coat - A tack coat is a light application of emulsified asphalt applied to an existing pavement to provide a bond with an overlying course. A tack coat is also applied to the sides of joints.

Thin Overlay – A single lift HMA overlay with a thickness of 38 mm (1.5 in) or less.

Transverse Crack – A discontinuity in a pavement surface that is generally oriented perpendicular to the pavement centerline. In HMA pavements, transverse cracks often form as a result of thermal movements of the pavement or reflection from underlying layers.

Ultra Thin Overlay – An HMA overlay over an existing HMA or PCC pavement and is less than 25 mm (1 in) in thickness. May also be called a thin bonded wearing course.

Working Crack – A crack in a pavement that undergoes significant deflection and thermal opening and closing movements greater than 2 mm (1/16 in), typically oriented transverse to the pavement centerline.

Appendix E

PAVEMENT CONDITION SURVEY

Airfield _____ Date _____

Inspected by: _____

Facility (Runway, Taxiway, or Apron) _____

Length (ft) _____ Width (ft) _____

Construction Date _____

Pavement Type (Asphalt/Concrete) _____ Thickness (in) _____

Pavement Condition Index (PCI) _____ Date of PCI _____

Maintenance History _____

Pavement Distress

Cracks

Longitudinal Cracks	Length	_____ ft	Width	_____ in	Spalling (Y/N)	_____
Transverse Cracks	Spacing	_____ ft	Width	_____ in	Spalling (Y/N)	_____
Block Cracking	Spacing (ft)	_____ ft	Width	_____ in	Spalling (Y/N)	_____
Reflective Cracking	Length	_____ ft	Width	_____ in	Spalling (Y/N)	_____
Fatigue (Alligator) Cracking	% Area -	_____ %	Width	_____ in	Spalling (Y/N)	_____
Comments	_____					

Disintegration

Raveling	Area -	_____ sq. ft.	
Potholes	Area -	_____ sq. ft.	
Asphalt Striping	Area -	_____ sq. ft.	
Blast Erosion	Area -	_____ sq. ft.	
Patching and Utility Cut Patch	Area -	_____ sq. ft.	Spalling (Y/N) _____
Comments	_____		

Distortion

Rutting	Area -	_____ sq. ft.	Depth	_____ in
Corrugation	Area -	_____ sq. ft.	Depth	_____ in
Shoving	Area -	_____ sq. ft.	Depth	_____ in
Depression	Area -	_____ sq. ft.	Depth	_____ in
Swelling	Area -	_____ sq. ft.	Depth	_____ in
Comments	_____			

Skid Resistance

Comments

PASER Rating (1-5)

Rating guidelines are in FAA AC150/5320-17, AIRFIELD PAVEMENT SURFACE EVALUATION AND RATING MANUALS Appendix 1
http://www.faa.gov/airports_airtraffic/airports/resources/advisory_circulars/media/150-5320-17/150_5320_17_part2.pdf