

STATE OF CALIFORNIA DEPARTMENT OF TRANSPORTATION
TECHNICAL REPORT DOCUMENTATION PAGE

TR0003 (REV. 10/98)

1. REPORT NUMBER CA09-0637	2. GOVERNMENT ASSOCIATION NUMBER ISSN 1055-1425	3. RECIPIENT'S CATALOG NUMBER
4. TITLE AND SUBTITLE Analysis Toward Mitigation of Congestion and Conflicts at Light Rail Grade-Crossings and Intersections		5. REPORT DATE January 2009
		6. PERFORMING ORGANIZATION CODE
7. AUTHOR(S) Wei-Bin Zhang, Meng Li, Guoyuan Wu, Scott Johnson		8. PERFORMING ORGANIZATION REPORT NO. UCB-ITS-PRR-2009-9
9. PERFORMING ORGANIZATION NAME AND ADDRESS CALIFORNIA PATH PROGRAM INSTITUTE OF TRANSPORTATION STUDIES UNIVERSITY OF CALIFORNIA, BERKELEY		10. WORK UNIT NUMBER
		11. CONTRACT OR GRANT NUMBER 65A0161
12. SPONSORING AGENCY AND ADDRESS California Department of Transportation Division of Research and Innovation, MS-83 1227 O Street Sacramento CA 95814		13. TYPE OF REPORT AND PERIOD COVERED Final Report
		14. SPONSORING AGENCY CODE
15. SUPPLEMENTAL NOTES		

16. ABSTRACT

Reports on an in-depth study of problems associated with grade crossings configured with an adaptive trolley signal priority (ATSP) system. The system is designed for large-scale field implementation of the ATSP System and consists of three sub-systems: an onboard sub-system, a roadside control subsystem and a central control sub-system.

Laboratory design testing was conducted on the proposed ATSP system prior to a preliminary field operational testing (FOT) of the system in San Diego. These tests are used to demonstrate the applicability of a proposed FOT. The proposed system utilizes the QuicNet/4 central control system as used in the San Diego Transportation Management Center (TMC) and Type 170 controllers at the roadside.

Overall performance of the proposed ATSP system was not as successful as expected. The maximum average reduction on average number of stops and average travel time is less than 15%. Additional issues are observed and studied from the perspective of trolley operation, and traffic operation, Analysis indicates methodology may be suitable as a predictive tool for trolley movement and station dwelling time.

Identified issues are summarized and recommendations provided to further improve the system performance. A FOT is recommended to confirm findings and further justify use of adaptive signal priority systems to reduce congestion. The recommendations cover six aspects: signal transition, signal progression, dwelling time prediction, arrival time prediction at stations, integration of priority decision with prediction, and the automatic vehicle location (AVL) system.

17. KEY WORDS signal priority, adaptive signal optimization, at-grade crossing, light-rail, trolley, traffic simulation	18. DISTRIBUTION STATEMENT No restrictions. This document is available to the public through the National Technical Information Service, Springfield, VA 22161	
19. SECURITY CLASSIFICATION (of this report) Unclassified	20. NUMBER OF PAGES 71	21. PRICE N/A

DISCLAIMER STATEMENT

This document is disseminated in the interest of information exchange. The contents of this report reflect the views of the authors who are responsible for the facts and accuracy of the data presented herein. The contents do not necessarily reflect the official views or policies of the State of California or the Federal Highway Administration. This publication does not constitute a standard, specification or regulation. This report does not constitute an endorsement by the Department of any product described herein.

For individuals with sensory disabilities, this document is available in Braille, large print, audiocassette, or compact disk. To obtain a copy of this document in one of these alternate formats, please contact: the Division of Research and Innovation, MS-83, California Department of Transportation, P.O. Box 942873, Sacramento, CA 94273-0001.

CALIFORNIA PATH PROGRAM
INSTITUTE OF TRANSPORTATION STUDIES
UNIVERSITY OF CALIFORNIA, BERKELEY

Analysis Toward Mitigation of Congestion and Conflicts at Light Rail Grade Crossings and Intersections

**Meng Li, Guoyuan Wu,
Scott Johnston, Wei-Bin Zhang**

**California PATH Research Report
UCB-ITS-PRR-2009-9**

This work was performed as part of the California PATH Program of the University of California, in cooperation with the State of California Business, Transportation, and Housing Agency, Department of Transportation, and the United States Department of Transportation, Federal Highway Administration.

The contents of this report reflect the views of the authors who are responsible for the facts and the accuracy of the data presented herein. The contents do not necessarily reflect the official views or policies of the State of California. This report does not constitute a standard, specification, or regulation.

Final Report for Task Order 5407

January 2009

ISSN 1055-1425

Task Order 5407

**Analysis Toward Mitigation of Congestion
and Conflicts at Light Rail Grade Crossings
and Intersections**

Prepared by:

California PATH

University of California, Berkeley

and

California Department of Transportation

in collaboration with

SANDAG, San Diego Trolley, Inc. (SDTI), City of San Diego

ACKNOWLEDGMENTS

This project is sponsored by the California Department of Transportation (Caltrans) under the Task Order 5407. This report was prepared in cooperation with the State of California, Business Transportation and Housing Agency, Department of Transportation, San Diego Association of Government (SANDAG), San Diego Trolley, and City of San Diego. The contents of this report reflect the views of the authors, who are responsible for the facts and the accuracy of the data presented herein. The contents do not necessarily reflect the official views or policies of the State of California. This report does not constitute a standard, specification, or regulation.

The authors of this report would also like to express our appreciation to Dan Lovegreen of Caltrans for his guidance and support, Dave Nelson, Paul Kretz, Thang Lian of PATH for their technical assistance and support.

Author List

University of California, Berkeley:

Meng Li

Guoyuan Wu

Scott Johnston

Wei-Bin Zhang

ABSTRACT

Although many different railroad grade crossing control products are available, the most challenging limitation to traditional grade crossing systems is their inability to deliver consistent warning times in response to varying train speeds and station stops (particularly nearside stops). As a result, rail-roadway crossings often generate conflicts and congestion for motorist traffic and sometimes delay trains.

By conducting system level analysis, this project will investigate the interactions and conflicts between urban/suburban rail and cross traffic. The information that is obtained will then be applied to develop practical solutions to minimize impacts on motor vehicle traffic and improve or maintain schedule adherence for rail operations. In the end, this project plans to conduct field testing of the developed solutions and algorithms on the San Diego trolley system.

The proposed active LRT priority system consists of four major components: train detector, train travel and dwelling time predictor, priority request generator, and traffic signal controllers. The train detection means can be either traditional point detection, such as the loop system, or continuous detection, such as the GPS based AVL system. Based on the collected field data, a travel time predictor and the dwelling time predictor were developed. Based on the predicted arrival, a Mixed-Integer Quadratic Programming (MIQP) model was developed. The objectives of this optimization model are two-fold: 1) to minimize intersection delays for trolleys by providing signal priority; and 2) to minimize impacts on other traffic incurred by the priority. By applying the proposed optimization model, the average trolley performance index (PI), which is the expected trolley passenger delay, is reduced enormously by **89.5%**. Moreover, the standard deviation of trolley PI is reduced significantly by 68.6%, which means trolleys' travel time is more stable with signal priority. Within the priority impacted cycles, the traffic delay is increased by 30.4%. The total intersection passenger delay is reduced by **66.8%**. We also conducted the simulation testing by implementing our signal control algorithm in Paramics. The PI for trolleys decreases by as much as 77% if we use the proposed signal control algorithm, although the PI of the cross street traffic increases by 27%. By adjusting the weighting factor in our MIQP model, we can reduce the delay for the cross street traffic, however, the time saved for trolley will not be so noticeable.

Key words: signal priority, adaptive signal optimization, at-grade crossing, light-rail trolley, traffic simulation

EXECUTIVE SUMMARY

Although many different railroad grade crossing control products are available, the most challenging limitation to traditional grade crossing systems is their inability to deliver consistent warning times in response to varying train speeds and station stops (particularly nearside stops). As a result, rail-roadway crossings often generate conflicts and congestion for motorist traffic and sometimes delay trains.

By conducting system level analysis, this project will investigate the interactions and conflicts between urban/suburban rail and cross traffic. The information that is obtained will then be applied to develop practical solutions to minimize impacts on motor vehicle traffic and improve or maintain schedule adherence for rail operations. In the end, this project plans to conduct field testing of the developed solutions and algorithms on the San Diego trolley system.

This report specifically summarizes what the team at PATH has done at this stage of Task Order 5407. We have conducted an in-depth study on problems associated with grade crossings for this project. We started from a thorough literature review from the following five perspectives: (1) legislation, regulations and guidelines; (2) signal operations near highway-rail grade crossings; (3) time-to-arrival prediction at grade crossings; (4) system evaluation and simulation and (5) existing grade crossing products and technology.

In order to explicitly understand the existing problems in the San Diego trolley system, a field data collection system was been installed at some “problematic” intersections and some selected trolley trains. The data collection system consists of four major components. The data server collects data from three data sources and parses them into a MySQL database. The first data source is San Diego traffic management center (TMC). Traffic signal timing data from local BITrans 170 controllers is collected at the TMC and then sent to the central data server through VPN connection. The second data source is ten selected intersections where road tubes and traffic counters have been installed. Traffic volume data is stored in counter memory cards which need to be manually picked up. The last data source is five selected trolley trains. Two of the trains are equipped with PC-104 based data acquisition systems, which include a GPS receiver, a GPRS wireless modem and a computer. The computer logs train status data such as GPS data, trolley door status (open/closed), wheelchair lift status (stowed/deployed), etc. The logged data is transmitted to the central data server via GPRS every four hours. The other three trains are equipped with simpler data acquisition systems which can only record train GPS data. The traffic control data and traffic volume data collected are used for the simulation study, which is discussed in a later section. This section focuses on the analysis of the GPS data collected from the trolley trains along the “L” shaped segment formed by the two corridors (C Street and Park Boulevard).

The proposed active LRT priority system consists of four major components: train detector, train travel and dwelling time predictor, priority request generator, and traffic signal controllers. The train detection means can be either traditional point detection, such as the loop system, or continuous detection, such as the GPS based AVL system.

Based on the collected field data, a travel time predictor and the dwelling time predictor were developed. The TTA predictor, which consists of travel time and dwelling time predictors, plays a crucial role in the priority system. If the TTA prediction error is big, the timing optimization model would squeeze a big part of green from other traffic to provide a wide band for the train. However, the signal timing optimization model can only provide a limited bandwidth for LRT trains. So an inaccurate TTA prediction would not only incur high delay for other traffic but also result in a high expected delay for the train itself.

Based on the arrival time obtained from the two predictors, a Mixed-Integer Quadratic Programming (MIQP) model was developed. The objectives of this optimization model are two-fold: 1) to minimize intersection delays for trolleys by providing signal priority; and 2) to minimize impacts on other traffic incurred by the priority. Three schemes have been developed according to the train schedule adherence. According to the evaluation through a numerical example, Scheme I is applied when a late train is approaching. In this case, the incoming train will be in need of signal priority. By applying the proposed optimization model, the average trolley performance index (PI), which is the expected trolley passenger delay, is reduced enormously by **89.5%**. Moreover, the standard deviation of trolley PI is reduced significantly by 68.6%, which means trolleys' travel time is more stable with signal priority. Within the priority impacted cycles, the traffic delay is increased by 30.4%. So each traffic vehicle that arrives in the priority cycle will wait for 4.1 more seconds in exchange with 25.3 seconds delay savings for the trolley. The total intersection passenger delay is reduced by **66.8%**. And its standard deviation is reduced by 70.8%. Based on the report from San Diego Trolley Inc. (SDTI), their on-time performance is higher than 90% in FY-2002, which means that a minority of trolley runs would require signal priorities. In such sense, Scheme I can keep most trains running on-time. Scheme II and Scheme III are for on-time trains and no train arrivals, respectively. They are both applied more frequently than Scheme I, can provide lots of benefits to other traffic.

We also conducted the simulation testing by implementing our signal control algorithm in Paramics. The PI for trolleys decreases by as much as 77% if we use the proposed signal control algorithm, although the PI of the cross street traffic increases by 27%. By adjusting the weighting factor in our MIQP model, we can reduce the delay for the cross street traffic, however, the time saved for trolley will not be so noticeable.

Table of Contents

TABLE OF CONTENTS	XI
1. LITERATURE REVIEW	1
1.1 LEGISLATION, REGULATIONS AND GUIDELINES.....	1
1.1.1 <i>Title 49 Transportation from the Code of Federal Regulations</i>	1
1.1.2 <i>Manual on Uniform Traffic Control Devices (MUTCD)</i>	1
1.1.3 <i>Public Utilities Commission (PUC)</i>	3
1.1.4 <i>Railroad-Highway Grade Crossing Handbook</i>	7
1.1.5 <i>Guidance on Traffic Control Devices at Highway-Rail Grade Crossings</i>	8
1.2 TRAFFIC SIGNAL OPERATIONS NEAR HIGHWAY-RAIL GRADE CROSSINGS	9
1.2.1 <i>Signal preemption for trains</i>	9
1.2.2 <i>Signal priority for light rail transit (LRT)</i>	11
1.3 TIME-TO-ARRIVAL PREDICTION AT GRADE CROSSINGS	14
1.4 SYSTEM EVALUATION AND SIMULATIONS	16
1.5 EXISTING GRADE CROSSING CONTROL PRODUCTS AND TECHNOLOGY	17
1.5.1 <i>Grade Crossing Control System</i>	17
1.5.2 <i>Track Circuit</i>	19
2. SAN DIEGO TROLLEY LIGHT RAIL SYSTEM	23
2.1 HISTORY AND STATUS QUO	23
2.2 GRADE CROSSING CASE STUDIES	25
3. FIELD DATA COLLECTION SYSTEM AND DATA ANALYSIS	30
4. TROLLEY MOVEMENT AND DWELL TIME PREDICTION	34
4.1 TROLLEY MOVEMENT PREDICTION	34
4.2 DWELLING TIME PREDICTION.....	36
4.2.1 <i>Dwelling time observation</i>	36
4.2.2 <i>Dwelling time prediction</i>	38
4.2.3 <i>Data used for model estimation</i>	38
4.2.4 <i>Dwelling time model estimation</i>	39
5. THE PROPOSED ACTIVE SIGNAL PRIORITY SYSTEM	41
5.1 SIGNAL TIMING OPTIMIZATION MODEL.....	41
5.2 CASE STUDY AND PARAMETRIC PROGRAMMING	45
6. SIMULATION STUDY AND RESULTS	51
6.1 STATION DWELL TIME PREDICTION.....	51
6.2 CALIBRATION OF SIMULATION MODEL.....	51
6.3 SIMULATION RESULTS	52
7. SUMMARY	54

1. Literature Review

1.1 *Legislation, regulations and guidelines*

1.1.1 Title 49 Transportation from the Code of Federal Regulations¹

The railroad grade crossing requirement and regulation exists in many governmental documents. Among them, the Title 49 Transportation from the Code of Federal Regulations has the authority of defining grade crossing related applications. Local governments may have published regulations on different aspects of grade crossings. However, the primacy of the Federal Regulations cannot be challenged.

Within the document scope, whenever applicable, the minimum standard should be followed. This involves system-wide quality assurance such as repair, replacement, and some very basic requirements that include voltage level, flashing times and shunting sensitivity. These requirements and regulations have long been accepted by railroads with even more restricted implementation. Overall, it is not difficult to implement the requirement.

A basic rule is the fail-safe principle. This means any crossing system design has to activate the most restrictive control in case of malfunction. It does not define how to achieve the fail-safe or the criteria of the fail-safe.

The minimum time interval for maintenance and testing of crossing components has been defined for different types hardware. The intervals vary from weeks to months depending on the component. For example, the standby power system needs to be tested at least once a month.

Reporting is associated with system malfunctions and accidents. Format and criteria are defined to fulfill the requirement.

Penalty should be applied to the violation of the law.

1.1.2 Manual on Uniform Traffic Control Devices (MUTCD)²

This document is issued by FHWA and has the power of the law. It defines traffic devices used for streets and highways. Most of the document defines the basic

¹ U.S. Department of Transportation, Revised October, 1 2003, <http://www4.law.cornell.edu/uscode/html/uscode49/>

² FHWA, Manual on Uniform Traffic Control Devices, 2003 Edition, <http://mutcd.fhwa.dot.gov/>

requirements and application features for control devices. This includes color, size, location, illumination and retro reflection as well as rules of implementation. Since highway-railroad grade crossing are widely used, the control devices and behavior of the systems has been defined as well.

There are two type of grade crossings classified in MUTCD: highway-railroad grade crossing and highway-light-rail transit grade crossing. Correspondingly, there are two parts in the MUTCD that define the requirements and regulation for the types. The two parts share many common features such as the colors and sizes of many passive and active control devices.

- Part 8: Traffic Controls for Highway-Rail Grade Crossings

Grade crossing control is defined as a system with properly selected control devices, proper installation and operations that provide reasonable safety to roadway users as well as rail vehicles.

Authorities and engineering studies have defined and promoted good practices to improve the quality and safety of crossings. For example, the five basic considerations adopted are design, placement, operation, maintenance and uniformity. Many discussions are related to these considerations.

Signs and markings are defined in a more detailed fashion in section B. These control devices have predefined sizes, colors, shapes and contents. They can be installed as passive control devices.

Active control devices are flashing lights, gates and traffic control signals. They are usually associated with train detection devices. The mechanical and electrical characteristics of those control devices have been defined in detail. For train detection, the fail-safe principle and a minimum of 20 seconds warning time should be followed.

Interconnection and preemption between crossing and highway signals are defined and there is much discussion over the issues of its application.

- Part 10: Traffic Controls for Highway-Light Rail Transit Grade Crossings

The Light Rail Grade crossing control is different from regular highway-rail crossing control because of its unique environment. LRT can operate in a mode exclusive alignment, a semi-exclusive alignment and/or a mixed-use alignment. The exclusive alignment typically is grade separated. Semi-exclusive has highway-rail crossing. The mixed-use alignment is a unique condition because LRT shares the roadway with other roadway users.

Passive control devices are similar to Part 8. Active control devices are almost identical to Part 8 with minor differences such as audible alarms and active warning message signs.

1.1.3 Public Utilities Commission (PUC)

A number of general orders adopted and enforced by the PUC describe the operation and regulation guidelines for rail and light-rail vehicles as well as for grade crossings. A brief summary is given below.

The most relevant general orders of the PUC are highlighted as follows:

- General Order GO-26
General Order 26 is mainly about overhead and side clearance of rail car operations.
- General Order GO-72B
General Order 72B describes the requirements of grade crossing with instructions on width, grade, surface construction, and responsible jurisdictions for the grade crossing area.
- General Order GO-75C
General Order 75C provides guidelines of grade crossing protection. The most noteworthy section, 7.10, contains the following language:

7.10 TRAFFIC SIGNALS NEAR GRADE CROSSINGS -

At some streets and highways, railroad tracks pass in or near the intersection and are protected by traffic signals. At such intersections, preemption of the traffic signals by the railroad signals to avoid conflicting aspects of the traffic signals and the railroad crossing signals should be provided. (Refer to "Manual on Uniform Traffic Control Devices for Streets and Highways", Department of Transportation, Federal Highway Administration, 1971 Edition, Section 4B-21 (as amended) for details of installation and operation).

- General Order GO-88
General Order 88 is mainly about alteration criteria of existing public highway-rail crossings. The criteria for alteration are (1) the public agencies having jurisdiction over the roadway involved and the railroad corporation shall be in agreement as to the public necessity for altering the existing highway-rail crossing, and (2) the proposed alteration(s) shall comply with all applicable Commission General Orders.
- General Order GO-135
General Order 135 describes the guidelines of grade crossing occupancy. A few most relevant sections of language are attached here.

TRAIN MOVEMENTS –

Except as provided in Paragraph 5, a public grade crossing which is blocked by a stopped train, other than a passenger train, must be opened within 10 minutes, unless no vehicle or pedestrian is waiting at the crossing. Such a cleared crossing must be left open until it is known that the train is ready to depart. When re-coupling such a train at the crossing, movement must be made promptly, consistent with safety.

SWITCHING MOVEMENTS –

Switching over public grade crossings should be avoided whenever reasonably possible. If not reasonably possible, such crossings must be cleared frequently to allow a vehicle or pedestrian to pass and must not be occupied continuously for longer than 10 minutes unless no vehicle or pedestrian is waiting at the crossing.

GRADE CROSSING PROTECTION CIRCUITS –

Cars or locomotives must not be left standing nor switches be left open within the controlling circuits of automatic gate protection devices unless time-out features are provided to allow the gate arms to rise.

- General Order GO-143B
General Order 143B describes the regulations governing light-rail. A few most noteworthy sections are highlighted below.

Section 2: Definition

2.01 AUTOMATIC BLOCK SIGNAL SYSTEM (ABS).

A series of consecutive blocks of track over which entry to each block is governed by block signals, cab signals, or both, which are actuated by the presence of an LRV or train or by certain other conditions affecting the use of the block.

2.02 AUTOMATIC TRAIN PROTECTION (ATP).

A system for assuring safe train movement by a combination of train detection, separation of trains running on the same track or over interlocked routes, over-speed prevention, and route interlocking.

2.03 AUTOMATIC TRAIN STOP (ATS).

A device so designed and installed that, should the operator permit a train to pass a signal indicating "stop", there will be an automatic application of the brakes which cannot be released until the train is brought to a stop.

2.07 FAIL-SAFE.

A characteristic of a system, which ensures that any malfunction affecting safety will cause the system to revert to a state that is know to be safe.

Section 4: Brake on light-rail vehicles

4.02 BRAKING SYSTEMS.

Every LRV shall have a service and an emergency braking system. The service braking system shall consist of a combination of dynamic and friction brakes. The

emergency braking system shall consist of a combination of the service braking system and independent magnetic track brakes.

4.10 DOOR INTERLOCK.

The passenger side door shall be interlocked with the braking and propulsion control systems in such a manner that a stopped LRV cannot start and a LRV in motion will automatically brake if the doors are not closed.

4.12 DEADMAN CONTROL.

Every LRV shall be equipped with a safety device that requires the operator's continuous pressure or activity to remain activated. The safety device shall be interconnected with the propulsion and service braking system in such a manner that should the device fail to detect an appropriate level of activity or pressure exerted by the operator, propulsion power will be interrupted, brakes will be automatically applied in a non-retrievable manner, and the train will be brought to a stop.

Section 7: Operating speed and train protection requirements

7.01 BASIC SPEED RULE.

The other provisions of this part notwithstanding, the operator of an LRV shall at all times operate at a safe speed that is consistent with weather, visibility, track conditions, traffic, traffic signal indications, and the indications of ATP systems where used.

7.02 SPEED PROFILE.

LRVs shall be operated at all times within the maximum speed profiles established for the system. Speed limit signs which are visible from the operator's cab shall be posted in advance of critical locations.

7.03 MAXIMUM SPEEDS.

The maximum speeds permitted on an LRT shall be established in accordance with the requirements presented in Table 1 (See Page 27).

7.04 CONDITIONS RESTRICTING MAXIMUM SPEED.

Maximum speed shall be restricted over track with opposing traffic when LRV movements are not governed by block signals, cab signals, timetable, train order, current of traffic, or manual block system. In the absence of such control systems LRVs shall operate with caution at a speed prepared to stop within one half the distance of the operator's range of vision but not exceeding twenty-five (25) miles per hour.

7.05 SPEED PERMITTED ON PEDESTRIAN MALLS.

Maximum LRV speed permitted on a promenade, pedestrian walk, concourse, mall, or plaza, which is closed to motor vehicles but where pedestrian movement across the tracks is authorized, is twenty (20) miles per hour unless otherwise restricted (see Table 1 on page 27).

7.06 TRAIN SIGNAL SYSTEM STANDARDS.

The Signal Manual of Recommended Practices published by the Communication and Signal Division of the Association of American Railroads shall be used as a guide for the design and construction of LRT signal systems. When alternative standards are followed, they shall be specifically noted on the signal plans and

specifications submitted to the Commission in accordance with Section 16.03 of this General Order.

7.07 CROSSINGS OF RAILROAD AND LRT AT GRADE.

As required by Division 1, Chapter 6 of the State of California Public Utilities Code, the permission of the Commission shall be obtained before any LRT tracks are constructed at grade across any railroad or LRT tracks. LRT movements over alignments 9.04 (a) and 9.04 (b) (1) at grade across railroad or LRT tracks shall be governed by an interlocking installation. All signal indications and train movements within the interlocking limits shall be recorded by automatic recording apparatus. The provisions of General Order 33-B shall not apply to tracks used exclusively for LRT operations.

7.08 CROSSINGS OF STREETS AND HIGHWAYS AT GRADE.

LRT systems which cross streets, roads, and highways at grade shall install and maintain automatic gate crossing signals to control motor vehicle traffic and automatic warning signals to control pedestrian traffic. When LRV operation is upon a street or highway permitting motor vehicle traffic, all intersections shall be controlled by traffic control devices. The following general orders shall govern the protection and operation of grade crossings.

General

Order Nos.	Subject
75-C	Protection of At Grade Crossings
135	Rules for Train Occupancy of At-Grade Crossings
145	Rules from Exempting Certain At-Grade Crossings from Motor Vehicle Stop Requirements

Section 9: Right of way standards

9.04 ALIGNMENT CLASSIFICATION.

a. Exclusive:

A right-of-way without at-grade crossings that is grade-separated or protected by a fence or substantial barrier, as appropriate to the location, including subways and aerial structures.

b. Semi-Exclusive:

(b.1) Fully exclusive right-of-way with at-grade crossings, protected between crossings by a fence or substantial barrier, if appropriate to the location.

(b.2) Within street right-of-way, but protected by six-inch high curbs and safety fences between crossings. The safety fences should be located outside the tracks.

(b.3) Within street right-of-way, but protected by six-inch high curbs between crossings. A safety fence may be located between tracks.

(b.4) Within street right-of-way, but protected by mountable curbs, striping, or lane designation.

c. Non-Exclusive:

(c.1) Mixed traffic operation-surface streets.

(c.2) LRT/Pedestrian Mall.

- General Order GO-145
General Order 145 is mainly about regulations governing railroad grade crossing to be exempt from the mandatory stop requirements of section 22454 of the vehicle code.
- General Order GO-164B
General Order 164B provides a list of about rules and regulations governing state safety oversight of rail fixed guide-way systems.

1.1.4 Railroad-Highway Grade Crossing Handbook³

Produced by FHWA, this book contains useful information for grade crossing planning, implementation and evaluation. The handbook has walked through all the phases in designing a grade crossing. It approaches the topic from two basic component groups: highway and rail.

Highway component includes driver, vehicle, roadway and pedestrian. The railroad component includes track and train. The characteristics of those components have been discussed in detail as well as the relationships between the components.

With the understanding of the basic components, the next step is to assess the crossing safety and operation. This is done by following the planning component of the FHWA procedure which includes planning, implementation, and evaluation. The planning stage is associated with data collection and analysis, engineering study and establishment of priorities for implementation. Forms of data and analyzing algorithms are discussed. The result is a prioritized plan that will be further consolidated by an engineering study. Studying the crossing in terms of “entire system” may sometimes be very helpful. This is called the system approach.

The next step is to identify and select alternatives based on the analysis and engineering study. Many alternatives are available such as grade elimination, passive control or active controls, or they can be as simple as to improve sight distance. These are discussed in a detailed fashion.

Economics is another concern in improving grade crossings. The handbook provides several analysis methods: Cost-Effectiveness, Net Annual Benefit, Benefit-Cost analysis for the user to compare the alternatives.

³ B.H. Tustin, etc., FHWA, Railroad-Highway Grade Crossing Handbook - 2nd Edition, September 1986, <http://www.fhwa.dot.gov/tfhrc/safety/pubs/86215/intro.htm>

The implementation component is concerned with funding issues, design issues and construction issues. The evaluation component is basically to determine the effectiveness and safety improvement from the view of crossing operation and management.

1.1.5 Guidance on Traffic Control Devices at Highway-Rail Grade Crossings⁴

This report tries to put different perspectives together to provide a better description of existing requirements and regulations. Highway-Rail grade crossings have a road user and a control system component. The interaction and relationship between the two makes the entire grade crossing scheme. As a road user, the notice of approaching rail vehicles is affected by multiple factors: sight distance (stop, approach and clear); traffic control devices; the user's ability to make correct decisions at the crossing. These are often dynamically changed based on the surrounding environment. On the other hand, the crossing "control system" affects the user directly. The report has listed various factors which contribute to the selection of control devices. For example, roadway capacity, rail traffic, level of services for roadway and rail, school and industrial surroundings, history of accidents and among others, can affect control device selection.

There are two categories for control devices: passive and active. The report lists a table for currently used passive control devices. An active control device "gives warning of the approach or presence of a train." Typical active devices include flashing lights and gates. Other types of active control devices include active warning signs with flashers and active turn restriction signs.

Train detection is a part of an active warning system. It provides warning time and affects system credibility. There are different types of detection. These types of detection, based on functioning logic, can introduce a large variation in providing reasonable warning time. Among them the Constant Warning Time systems provide better results.

When preemption and interconnection is needed, the report suggests that several factors be considered. These include the extended warning time scenario, the second train coming with multiple tracks scenario and the diagonal railroad crossing across highway intersection scenario. These scenarios describe potentially dangerous conditions and need special care.

⁴ U.S. Department of Transportation, FHWA, GUIDANCE ON TRAFFIC CONTROL DEVICES AT HIGHWAY-RAIL GRADE CROSSINGS, November 2002, <http://safety.fhwa.dot.gov/media/twgreport.htm>

1.2 Traffic Signal Operations near Highway-Rail Grade Crossings

The terms priority and preemption both refer to preferential treatment given to transit vehicles at traffic signals to minimize delays to both transit and other traffic. Preemption is intended to imply a near-immediate response that is consistent with safety, whereas priority is intended to consider signal performance or safety before granting preference to transit.

1.2.1 Signal preemption for trains

The major strategies and technologies of railroad preemption are summarized in the following table. Each strategy or technology has its own pros and cons, therefore, different methods or devices may be applied, taking into account specific situations.

Table 1 Summary of railroad preemption

	Types	Methods
Conventional Preemption Strategies	Interaction with Traffic Signal	Single-break, Two-wire Interconnection Circuit
		Double-break, Four-wire Interconnection Circuit
		Double-break, Interconnect Circuit with Supervision and Gate Horizontal Control
	Preemption Timing	Minimum Warning Time
		Right-of-Way Transfer Time (RWTT)
		Queue Clearance Time
		Separation Time
Railroad Crossing Protection Technologies	Classic System for Detection	Three-track Circuits
		Motion Detector
		Constant Warning Time (CWT)
Crossing Warning Systems	Passive (Independent from train operations)	Warning Signs (Crossbucks) Pavement Markings
	Active (dependent on or triggered by train)	Crossing Gates
		Flashing Lights
Enhancements to Reduce Congestion	Delayed Gate Lowering at Nearside Light-Rail Platforms	
	White Transit “T” Indication	
	Four Quadrant Gate Systems	
	Pre-signal	
	Advanced Preemption	
	Adaptive Traffic Signal Phasing	

Innovative Preemption Strategies & Technologies	Traffic Signal Software
	Variable Message Sign (VMS)
	2 nd Train Warning System
	Emergency Vehicle Priority
	Radar Obstacle Detection System
	Trapped and Stalled Vehicle Detection
	Photo Enhancement
	Video Detection System
	Transit Vehicle Tracking (Mainly Using GPS)
	Real-Time Railroad Crossing Status Monitoring
	In-Roadway Warning Light at Railroad Crossing
	Automated Horn System (AHS)

For example, the *three-track circuit* shown above can not handle trains that slow to a stop before reaching the intersection or trains that back up after passing the intersection. But *motion sensor* and *CWT devices* will deactivate if a train stops within the approach circuit. Taking another example, in the crossing warning systems, *passive warning devices* are low in cost and can be quickly implemented, but provide low benefits for congestion relief. Active warning devices can provide real-time notification and greater benefit, but they are more complex and expensive. For a more illustrative example, *adaptive traffic signal phasing* and *variable message sign* are very useful and valuable in many cases, but they might require a large amount of programming, and may cost much more than other devices. In general, determining the selection of strategies and technologies and the optimum combination of them is not trivial.

Typical railroad preemption procedures at signalized intersections include:

- *Prior to the train crossing:* The railroad crossing controller will receive a train approaching signal from detection equipment, and then initiate the warning devices and the necessary traffic signal preemption events (including the clearance of tracks).
- *During the train crossing:* The warning devices will be activated for at least a minimum amount of time prior to the arrival of the train at the crossing. When the automatic crossing gates are lowered and all movements towards the track have stopped, the traffic signal may implement a limited phasing sequence.
- *After the train crossing:* The railroad crossing controller will trigger the automatic gates to rise and stop the flashing signals and horns. Then, the traffic is allowed to move normally.

Recently, the Texas Transportation Institute (TTI) developed the transition preemption strategy (TPS) algorithm⁵. This algorithm was to ensure that as the preemption was initiated by approaching trains, the signal would not change to endanger either

⁵ Jacobson, M., Venglar, S., and J. Webb, Advanced Intersection Controller Response to Railroad Preemption – Stage I-IV Report, Texas Transportation Institute, Texas A&M University, College Station, Tex., May 1999-February 2000.

pedestrians or drivers. In addition to a constant warning time (CWT) detector, the TPS algorithm required a new upstream detector, such as a sonic detector, Doppler radar detector, AVI or other detector, to get the constant advance preemption warning time (APWT). The time between the activation of the two detectors is the TPS operation time.

The data from APWT detector is fed into a train arrival time prediction algorithm. Because of the variability of the predicted arrival time, the TPS algorithm can be cut abruptly which may result in safety problems or can have extra green period in the track clearance phase which may result in excessive intersection delay. Therefore, an improved transition preemption strategy (ITPS)⁶ was designed to provide more green time to the phases that will be blocked during preemption, as compared to the normal traffic signal mode and the TPS algorithm.

A signalized intersection in College Station, Texas, along a railway corridor was chosen as the test bed to test the ITPS algorithm. A Doppler radar detector, located approximately 2.2 km (1.4 mile) upstream, can provide train speed continuously while it is in the detection area. Although no field result from the test bed was discussed in the paper, a simulation network, based on VISSIM plus vehicle actuated programming (VAP), had been set up to duplicate the test bed. Comparing with standard preemption, current TPS, the simulation results indicated that the ITPS algorithm with an APWT value of 100, 110, or 120 seconds is the more efficient operation strategy for both safety and efficiency.

1.2.2 Signal priority for light rail transit (LRT)

Within the realm of priority, there are two different strategies: passive and active. Passive priority presets the signal timing to favor transit vehicles, whereas active priority makes downstream signal timing adjustments upon detection of a transit vehicle.

1.2.2.1 Passive priority

(1) Trolley Priority in Downtown San Diego⁷

In order to provide San Diego Trolley with uninterrupted movements through signalized intersections, a preemption system was established in the downtown area in 1981. Traffic signals alter the normal operation and provide one-way progressive movement for trolleys when the vehicle pantograph initialized preemption pulses by striking contacts on the overhead catenary systems. The traffic signal would return to normal operation after the trolley had passed.

⁶ Cho, H., and L. R. Rilett, Improved Transitional Preemption Strategy for Traffic Signals at Intersections Near Highway-Railway Grade Crossings, *Transportation Research Board 83rd Annual Meeting*, 2004.

⁷ Celniker, S. and E.W. Terry, Trolley Priority on Signalized Arterials in Downtown San Diego, *Transportation Research Board*, No. 1361, pp. 184-187.

As the trolley system expanded and the service frequency increased, the previous preemption system was unable to accommodate the increased preemption requests. Sometimes several trolley preemptions would be entered in rapid succession, creating significant delays for other traffic and pedestrians.

In 1990, a trolley priority system was developed in a cooperative effort between the city of San Diego and San Diego Trolley, Inc. The system works as follows:

- The trolley dwells in the trolley station until the beginning of the next green light at the first downstream signal.
- The trolley departs within 5 sec of the beginning of the green light.
- If the departure window is missed, the trolley must wait until the beginning of the next green light.
- As long as the trolley leaves the station during the departure window, the trolley will receive green lights at all of the signals until it reaches the next station.
- The two-phase, fixed-time signal timing favorable to the trolley is always in place and is fitted into the larger network of signals.

In the trolley priority system, all signalized intersections in the control zone would change in succession favoring the trolley. Timing was based on an average train speed of 25 miles per hour.

The trolley priority system has proven to be successful at increasing the efficiency of trolley operations through downtown San Diego. Also, the system is a simple and easy implemented solution to the complex problem of motor vehicles, pedestrians, and trolleys operating together on streets under traffic signal control. However, some concerns regarding the system remain. First, significant train delay is experienced if the train operator is not ready to depart the station in the initial green light phase. Second, the departure window is not designated by any special indication and it requires the operators to guess in borderline situations. Thus, the operators may sometimes miss the window and hit a red light before reaching the next station. Third, a train waiting for a green light might prevent a following train from entering the station platform. In a worse manner, the two trains could block one or more intersections and thus cause significant traffic congestion. Finally, the passive priority strategy typically makes the intersections operate less efficiently overall, especially when traffic demand is high, because the signal setting will be sub-optimal when transit vehicles are not present. Therefore, an adaptive priority system is needed to improve the efficiency of the trolley and signal operations.

(2) Case studies⁸

⁸ Walters, C. H., Steven P. Venglar, Daniel B. Fambro, and Janice R. Daniel, Development of Analytical Tools for Evaluating Operations of Light-Rail At-grade within an Urban Signal System, Texas Transportation Institute, March 1993.

Table 2 Some Selected LRT Studies

City	LRV Location	LRT Operations
San Diego, CA	Median, mixed traffic, and exclusive	LRV has passive priority. Train operators need to wait for green light at stations ⁹ .
Los Angeles, CA	Median	System uses custom designed software in the controller which allows full, partial, or total preemption ¹⁰ .
Boston, MA	Median and mixed traffic	Automatic vehicle identification (AVI) system and voice communication between trains and the operation control center (OCC). No signal priority for LRVs, but LRT operations include four types of control actions: holding a train, short-turning, expressing, and deadheading ¹¹ .
Buffalo, NY	Median	LRV preemption requested by train operator.
Calgary, Canada	Median and exclusive	No preemption, fixed signal progression timed to LRT schedule using TRANSYT-7F ¹² .
Melbourne, Australia	Median, mixed traffic, and exclusive	SCATS provides dynamic active priority phasing.
Portland, OR	Side	Signal progression favoring LRVs in downtown loop. Some cab operated full preemption with "decision point" markers on tracks ¹³ .
Sacramento, CA	Median and exclusive	Signalized intersections redesigned to accommodate LRV movements.
San Francisco, CA	Mixed traffic and exclusive	Among total 108 at-grade crossings, 20 controlled by traffic signals, 5 with LRV priority.
San Jose, CA	Median and mixed traffic	The NEMA controllers have been designed to permit any degree of LRV priority, from none to full. Roadway crossings generally have signal priority ¹⁴ .

⁹ Celniker, Stephen and Terry, E. Wayne, Trolley Priority on Signalized Arterials in Downtown San Diego, Paper prepared for presentation at the National Light Rail Transportation Conference, May 1991.

¹⁰ Taylor, Paul C., Lee, Leo K., and Tighe, Warren A., Operational Enhancements: Making the Most of the Light Rail, *Light Rail Transit: New System Success at Affordable Prices, TRB Special Report 221*, TRB, National Research Council, Washington D.C., 1982, pp.578-592.

¹¹ Wilson, N. H. M., et., Improving Service on the MBTA Green Line through Better Operations Control, *Transportation Research Record*, No. 1361, pp. 296-304, 1993.

¹² Walshaw, J. R., LRT On-Street Operations: The Calgary Experience, *Light Rail Transit: System Design for Cost-effectiveness, State-of-the-art Report 2*, TRB, National Research Council, Washington, D.C., 1985, pp. 221-226.

¹³ Fox, Gerald, Light Rail/Traffic Interface in Portland, -- The First Five Years, Paper presented at the 1992 TRB Light Rail Conference, Calgary, Canada, May 1992, pp. 1-17.

¹⁴ Tighe, Warren A. and Patterson, Larry A., Integrating LRT into Flexible Traffic Control Systems, *TRB State-of-the-art Report 2*, TRB, National Research Council, Washington, D.C., pp. 213-219.

1.2.2.2 Active priority

For active priority, a further distinction can be made between partial and full priority strategies. Partial priority extends green time or truncates red time for transit, whereas full priority has the ability to skip certain non-transit phases. In such sense, the aforementioned preemption can be thought of as a full priority strategy which only considers safety considerations.

1.3 Time-to-Arrival Prediction at Grade Crossings

The most common system to predict train arrival times is the one that is physically linked to the railroad track circuitry. This system, which is defined as first-generation technology, activates the warning device controller whenever a train's presence at a particular point in the track is detected.

Second-generation technology uses information available from non-intrusive devices mounted off the railroad right-of-way¹⁵. The technologies are being investigated through the TransLink Research Center at the Texas Transportation Institute. The statistical analysis of train data using a modular approach was able to accurately predict the arrival time of trains in the test bed in College Station, Texas. The modular method was able to predict the arrival time of a train to within 20 seconds of its true arrival time. Earlier predictions, when trains were between 200 and 300 seconds from the crossing, had an accuracy of 60 seconds. The modular method had high forecasting error because it assumes that the last observed speed will be constant until the train arrives at the crossing. Recently, Cho and Rilett (2003) developed a Modular Artificial Neural Network (MANN) approach which provided an average 19.5% improvement over a standard ANN model, an average 29.7% improvement over a multiple linear regression model and an average 46% improvement over the original modular model¹⁶.

Third-generation technology uses information from on-board detection systems. The Michigan Incremental Train Control System uses global positioning system transmitters mounted on trains to monitor their position along the track and provide up to three minutes of advanced notification to warning device controllers¹⁷. The Pacific Northwest Positive Train Separation (PTS) project uses similar technology to prevent train-train collisions.

The dwell time of a train at a station may be affected by many factors, grouped by Kraft into seven categories: human, modal, operating policies, operating practices, mobility,

¹⁵ Estes, R. M., Laurence R. Rilett, Advanced Prediction of Train Arrival and Crossing Times at Highway-Railroad Grade Crossings, *Transportation Research Record*, No. 1708, pp. 68-76.

¹⁶ Cho, H. and Laurence R. Rilett, Forecasting Train Travel Time, *Transportation Research Board 82nd Annual Meeting*, Washington, D.C., 2003.

¹⁷ Korve, H. W., Traffic Signal Operations Near Highway-Railroad Grade Crossings, *NCHRP Synthesis 271*, TRB, National Research Council, Washington, D.C., 1999.

climate/weather, and other system elements¹⁸. However, for a given system, most of these factors are constants. Lin and Wilson (1993) estimated dwell time for one- and two-car light rail operation based on the data from MBTA Green Line in Boston, MA¹⁹. The resulting model showed that both the numbers of passengers boarding and alighting and the level of passenger crowding on board significantly affect dwell time. Evidence was also found that the crowding effect may be nonlinear with the marginal delay increasing with number of standees. The estimated dwelling model showed that important differences exist between one- and two-car trains as a result of typically uneven distribution of passenger movements and passenger loads.

The last TOA prediction model we have reviewed is done by our own team at PATH in the Adaptive Transit Signal Priority (ATSP) project. In the ATSP project, a bus's absolute position and its corresponding coordinated universal time (UTC) are provided by Global Position System (GPS). The prediction algorithm uses real-time bus location and bus wheel speed information, together with historical AVL data to predict the arrival time of a bus at the next traffic light. The arrival time predictor is consisted of two models: 1) a historical model that predicts the arrival time based solely on the historical data and 2) an adaptive model that adaptively adjusts its filter gain based on the real-time AVL data that are "continuously" made available. The estimates generated by these two models are molded in a weighted average. The algorithm adaptively adjusts its weight distribution according to some error variances obtained from the historical and adaptive models.

Bus stops and signalized intersections are represented as nodes. The historical model relies solely on the historical data, assuming that the bus operating speed between two nodes can be modeled as a constant with an uncertainty. From the historical data recorded on the GPS equipped test buses, a least-square method is used off-line to calibrate the constant average speed and the variance of an error term, with which the arrival time and its associated variance can be calculated. In addition, a historical dwell time model is developed to consider the dwell time distribution at each bus stop. For each of the bus stops, the mean and variance of the observed dwell times are calculated and these two parameters are updated regularly as more AVL data are made available.

The historical model is useful in predicting an average travel time along a link. Finer tunings are obtained by using real-time speed and location data in an adaptive model that adapts to the flow (average speed) condition downstream. So the adaptive model complements the historical model and uses real-time AVL data to adaptively estimate the downstream bus average speed. For this, a recursive least-square method was developed with its filter gain adaptively adjusted based on the real-time AVL data.

¹⁸ W. H. Kraft, An Analysis of the Passenger Vehicle Interface of Street Transit Systems with Application to Design Optimization, Ph.D. dissertation, New Jersey Institute of Technology, 1975.

¹⁹ Lin, T. M. and Nigel H. M. Wilson, Dwell Time Relationships for Light Rail Systems, *Transportation Research Board*, No. 1361, pp. 287-295, 1993.

1.4 System Evaluation and Simulations

Stone and Wild (1982) compared level of service (LOS) versus total person delay to determine if LRT should be given intersection priority²⁰. LOS was calculated based on the techniques from the Highway Capacity Manual, 1965. Intersection configuration included both near-side and far-side transit stop locations. Calculations were made with and without LRT preemptions, with the exception of near-side configurations where preemption calculations were not made. Different LRT headways were from 2 to 20 minutes. The results indicated that the LOS calculation produced very few situations where preemption would be acceptable. The total person delay results were positive for many more situations. In general, increases in traffic volume lead to more justification for LRT preemption until headways reach 6 minutes. At this point, the delay to other traffic may be unacceptable.

Yagar and Heydecker (1988) utilized the TRANSYT model to study peak hour delays to both streetcars and other traffic in the Queen Street corridor in Toronto²¹. Fixed streetcar stop time and fixed-time signal control were assumed in this study. Weights assigned to streetcars were equivalent to 5 private vehicles in one scenario and 100 in another. The results indicated that there was a potential reduction in delay to streetcars of up to 25% with no additional delay to private vehicles.

Venglar et al. (1995) described the calibration and validation of a simulation model using the TRAF-NETSIM and TransSim IITm simulators²². Field data from five existing networks – two in Los Angeles, CA; one in Long Beach, CA; and two in Portland, Oregon – were used to test the models of existing and proposed systems. Calibration was required primarily for queue discharge and platoon dispersion in NETSIM. For TransSim IITm, the primary calibration needed was the location of the vehicle detector. Results of validation for both simulators indicated that the model outputs were more representative for system-wide travel times than for individual intersection MOEs.

This study also discussed how to model LRT networks in simulations. Four major at-grade configurations exist for LRT-roadway intersections: (a) isolated crossings; (b) isolated crossings with a nearby traffic control device; (c) crossings where LRT is adjacent to a parallel street; and (d) crossings from LRT median operation. For each type of crossing, there are modeling concerns such as the presence and handling of turning vehicles, the need to prevent cross-street vehicles from encroaching on the LRT tracks, the priority provided for LRVs, and optimal signal timing. For the LRT physical environment, five general classes of track locations ranging from least to greatest

²⁰ Stone, T. J., and William A. Wild, Design Consideration for LRT in Existing Medians: Developing Warrants for Priority Treatments, *Transportation Research Board Special Report 195; Light Rail Transit: Planning, Design, and Implementation*, pp. 170-175, 1982.

²¹ Yagar, Sam and Ben Heydecker, Potential Benefits to Transit in Setting Traffic Signals, *Transportation Research Board Special Report 221; Light Rail Transit: New System Successes at Affordable Prices*, pp. 657-667, 1988.

²² Venglar, Steven, and Danial B. Fambro, and Thomos Bauer, Validation of Simulation Software for Modeling Light Rail Transit, *Transportation Research Record*, No. 1494, pp. 161-166, 1995.

interactions with automatic traffic are: (a) grade separation; (b) exclusive right-of-way; (c) side of street; (d) median of street; and (e) mixed traffic. For LRT operations, researchers need to consider vehicle characteristics (maximum speed, acceleration, deceleration, and etc.), headways, dwell time, operation speed, and time factors at roadway crossings (blockage time, clearance time, and lost time). Moreover, different types of control at crossings include crossbucks only, flashing lights with crossbucks, flashing lights with gates and crossbucks, and standard control devices. Each control option has different blockage, clearance, and loss times. Finally, different priority treatment and strategies must be considered in the simulation model.

Taylor and Machemehl (1998) applied CORSIM plus Run-Time Extension (RTE) to evaluate different LRT signal priority strategies²³. The simulation results indicated that passive priority strategies were more effective than active strategies in reducing LRT person delay. In most of the passive priority scenarios, overall person delay was also significantly reduced. The most effective technique was prohibition of left turns, which was reasonable because it increased the green window for LRT. However, it might be infeasible based on other considerations. Signal progression that is segmented to account for stops at LRT stations yields favorable results. In contrast, the active priority technique, green extension signal priority in this study, showed no significant reduction in delay. Therefore, the type of active priority, tested in this research, is not a good candidate for the simulated network.

1.5 Existing Grade Crossing Control Products and Technology

1.5.1 Grade Crossing Control System

A grade crossing control system is the logical controller or circuitry designed by engineers to control a specific grade crossing location. A control can be implemented by using relay logic or a vital micro processor based controller or the combination of both. In the case of having a timing requirement, a Constant Warning Time system (grade crossing predictor) or motion sensor can be used.

The Constant Warning Time system²⁴ is widely used as a highway grade crossing control system. This type system is very well designed and has proven to be reliable. In this section, we will discuss some commonly used equipment.

There are still many grade crossing controls using regular fail-safe equipment such as Microlok. This is mainly because of control issues or cost-benefit concerns.

²³ Taylor, B. and Randy Machemehl, Development and Evaluation of Light Rail Transit Signal Priority Strategies, *Southwest Region University Transportation Center, Center for Transportation research University of Texas at Austin*, SWUTC/98/472840-00072-1, 1998.

²⁴ NCHRP Synthesis 271: Traffic Signal Operations Near Highway-Rail Grade Crossings

(1) Safetran Grade Crossing Predictor Model 3000 Series

This system is one of the most widely used micro processor based Constant Warning Systems. It continuously monitors train's shunting characteristics to provide protection. The system computes the time for an incoming train with the assumption of the train running at a constant speed.

A constant current signal is applied to the track. This current signal acts on the track impedance and gives voltage across the track. The impedance of the track varies from the length of the track which is determined by an incoming train. This causes the voltage change. The voltage change and the rate of the change together contribute to the calculation of warning time.

The GCP 3000 can be used for either single track or double track detection. Configuration is provided through a detachable keyboard and can change operating parameters such as warning time. The system has self-check feature which test the entire unit at specific time intervals.

In the case of traffic signal preemption, a DAX (Downstream Adjacent Crossing) model is used. The DAX output feeds into the local traffic signal control equipment via line or cable. It can also be used to extend the control by connecting multiple GCP together.

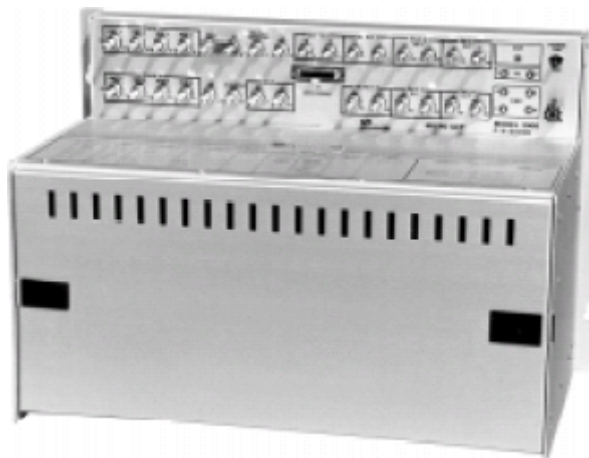

Figure 1 Safetran GCP 3000

(2) GE Highway Crossing Processor HXP-3

This GE grade crossing system provides similar control as Safetran GCP 3000. Like GCP, the HXP-3 can be configured as single or double track application. The HXP-3R models provide built in redundancy. Traffic preemption is implemented through an Auxiliary Crossing Driver (AXD) module.



Figure 2 GE HXP-3

(3) US&S Four-Quadrant Gate Highway Crossing Warning System

This system is an example of using fail-safe micro-processor based signaling equipment to control the grade crossing. The basic idea is to treat the crossing as an interlocking location within the railroad signaling system. The US&S Microlok II is the core of the system. It monitors approach tracks and island. With an inductive loop in the island, it is able to provide vehicle stall protection by keeping the exit gate open. It can also send cab signal to the locomotive to alert the train engineer of a stalled vehicle on the crossing.

1.5.2 Track Circuit

Track Circuit is the most commonly used means for train detection. The requirement and regulation of a track circuit can be found in FRA rules²⁵. The first track circuit was invented in 1872 as DC current track circuit. Since then there has been on-going development of track circuit hardware and theories. The following table has a list of different track circuits.

Table 3 List of Different Track Circuits

	TYPE of TRACK CIRCUIT	COMMENT
1	D-C coded track	
2	D-C none-coded	
3	A-C immunized	Steady energy, used in electrified area
4	A-C coded track	
5	A-C none coded track	
6	AC-DC track	Type-C or rectifier/DC relay
7	Audio-Frequency-Overlay	AFO-IIC, ATT-20, AFTAC II, PSO-III

²⁵ Title 49, Part 236

8	Motion Sensor	MODEL 660, 2000, PMD-3
9	CWT System	

The following is a typical track circuit. There is a relay at the receiving end. From the battery end, the V_{in} can be a DC, AC, or coded energy. The four vertical lines at both ends indicating the track circuit boundary. This boundary (insulated joints) electrically isolates the track circuit from all other adjacent track circuits. Inside the boundary, the electrical continuity of the rails is provided. When the continuity does not exist, broken rail is assumed.

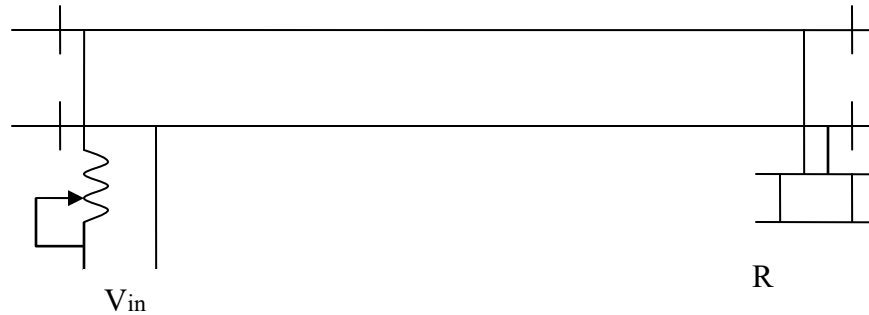

Figure 3 Typical Track Circuit

As a rule, the shunting sensitivity of 0.06 ohm applies to all track circuits. This means if a shunt of 0.06 ohm resistance is connected across the two track rails anywhere within the track circuit limit it will cause the track relay to be in a de-energized position.

The characteristic of a track circuit varies on many different conditions. This is mainly due to the complexity of the ballast. The ballast is defined as a combination of the ballast material such as crushed rocks and ties as well as the earth itself. As we know, the electric conductivity of a material always exists. Therefore the electrical leakage between the two rails exists. This leakage can be calculated from the Kirchoff network theory. The following is an equivalent circuit of a DC track.

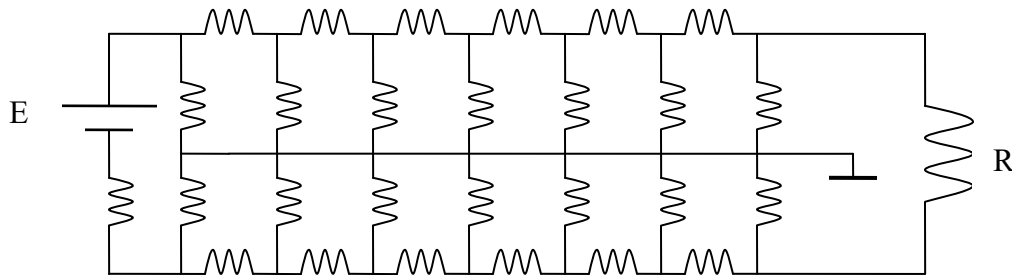

Figure 4 Equivalent Track Circuit (DC)

Unfortunately, Track circuits vary all the time. During a bad weather, such as thunderstorm, a track ballast electrical leakage grows dramatically. As the ballast dries out, the ballast resistance increases and the leakage drops. Contamination of ballast can make the case even worse. The range of the ballast resistance is very significant and sometimes causes a dramatic change on a track relay's current. The track relay may even drop due to the lack of the energizing current in an unoccupied situation. In this case, the output from the back contact of the track relay will cause the fail safe output of the control system and thus an adjustment is needed.

If the feeding energy is AC or coded energy, the scenario is more complicated because capacitance between the rails becomes a factor of the leaking current.

The so called Type-C track circuit is a simple and widely used. It uses DC track relay but driven by rectified AC current. There were also Type-A and Type-B, but Type-C has proven to be the best.

Type-C track circuit has good shunting performance as well as broken rail protection. It is often used in grade crossings as the approach track circuit because both relay and the energy feed stay at the same end of the circuit and can be easily put into a wayside case.

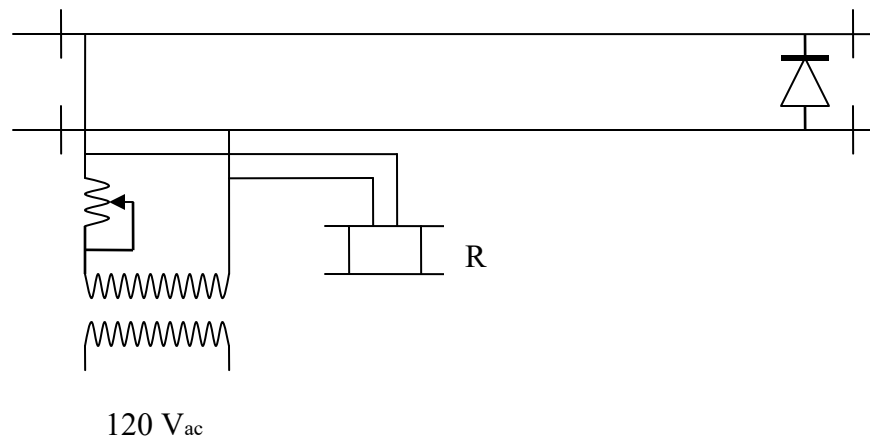

Figure 5 Type-C Track Circuit

The Audio-Frequency Overlay (AFO) track circuit does not require insulated joints. It has AFO transmitter and AFO receiver. The transmitter generates a user selected audio frequency signal that is being sent through rail. The receiver picks up the frequency signal and energizes the track relay. One of the benefits in using AFO is that the track circuit can co-exist with other track circuit as long as they are not in same frequency. The AFO is widely used in highway crossings, especially within LRT systems. For example, the US&S AFO-IIC²⁶ can be used in electrified territory (see Figure 4). Another US&S AFO track circuit ATT-20 is designed for non-electrified territories.

²⁶ Union Switch & Signal Inc: Audio Frequency Overlay System for Light Rail and Other Special Applications.

There are also other AFO type equipments for selection such as GE AFTAC-II, and Safetran PSO-III. They all use similar technologies and work well in grade crossings.

A motion sensor is somewhat like an AFO track circuit. It transmits a pre-selected audio frequency signal to the rails and calculates the track circuit impedance. The variation of the impedance indicates the train movement and direction. It activates the gate when impedance decreases and deactivates the gate when impedance increases to appropriate levels. If the impedance stops changing within a certain range, it means the train has stopped inside the detection area. This feature can be used to deal with a train that stops near a gate. With the older approach, the engineer has to install multiple track circuits with timer logic to deactivate the gate when a train stops near the gate²⁷

There are several motion sensors available. The Safetran Model 2000 is one of the latest among them. It is compatible with GCP3000, except the processor board. It offers automatic calibration, programmable frequencies, programmable remote start operation as well as “the UAX and Enable inputs” for more complex applications.

Since motion sensors measure impedance of the track, unstable ballast may cause it to falsely activate the gate.

A CWT (Constant Warning Time) System is an enhancement from motion sensor system. It has AFO type track circuit and constantly measures the rate of impedance change. This rate change contains the train speed information which is used for decision making.



Figure 6 US&S AFO-IIC

²⁷ FHWA: Railroad-Highway Grade Crossing Handbook

2. San Diego Trolley Light Rail System

This project plans to conduct a field test on the San Diego Trolley light rail system.

2.1 History and Status quo

Table 4 shows the history of rail service in San Diego. The San Diego Trolley light rail system has been operating since July 26, 1981. Their total FY-2002 riders were 25,432,952; average weekday ridership was 74,674. On-time performance is 99.0% (FY 02)²⁸. In its current 48-mile (77.2 km) LRT network, as shown in Figure 7, 3.4 miles is in mixed traffic operation using line-of-sight and standard traffic control devices; 42.8 miles is in uni-directional operation under Automatic Block Signal System (ABS); 2.0 miles is non-signalized; and 2.0 miles is on shared track. There are two distinct line segments: the Orange Line is 21.6 miles, the Blue Line is 25.2 miles. For both lines, the headway during AM/PM peak hours is 7½ minutes; that during mid-day is 15 minutes; that for late night service is 30 minutes. On Saturday evening, the Blue Line runs 24-hour night owl service.

Table 4 Chronicle of Rail Service in San Diego

When?	Event
July 3 rd , 1886	Transit service began
1888	The first electric street railway system was introduced
1889	Cable cars began to replace the horse-drawn streetcars
1949	Buses completely replaced the electric streetcars
1967	Privately owned transit system was purchased by the City
1976	MTDB was formed to reintroduced LRV
1981	Trolley began its operation
1985	The City transferred San Diego Transit to MTDB
In the 1990's	"The Coaster" was introduced

In the trolley network, the Blue Line has 31 stations, six of which are shared with the Orange Line in the downtown area. Other than the shared stations, Orange Line has an additional 18 stations. There are 83 grade crossings, 40 of which are on the Blue Line; the other 43 are on the Orange Line. Furthermore, 75 grade crossings are on public streets; 4 are on private streets; and 4 are rail-pedestrian crossings.

Below is the technical specification for LRT vehicles in San Diego. All the 123 trains are equipped with two-way hand held radios and mobile radios to contact with control center.

²⁸ San Diego Trolley, Inc., Technical Fact Sheet,
<http://www.sdcommute.com/agencies/MTS/SDTI/PDFs/sdtiJointServiceFS.pdf>

Table 5 Technical Specification for LRT Vehicles (San Diego Trolley, Inc.)

	Siemens/Duewag U-2 LRV	Siemens/Duewag SD-100 LRV
Fleet Size (#)	71	52
Length (ft)	79.66	81.60
Width (ft)	8.69	8.90
Maximum speed (MPH)	50	55
Acceleration (MPH/SEC)	2.7	3.0
Deceleration (MPH/SEC)	3.0	3.0



Figure 7 San Diego trolley map

2.2 Grade Crossing Case Studies²⁹

A comprehensive study was conducted by the City of San Diego in order to improve the traffic situation that has resulted from traffic signal preemption at at-grade crossings. Typical problems, such as multiple preemption events, traffic signal phasing, signal timing and applicability of different strategies, mainly including adaptive traffic signal phasing and Variable Message Signs (VMS) were under investigation.

All the strategies were evaluated in the following terms

- Ability to reduce congestion
- Relative cost of implementation
- Necessary approvals and coordination required

Table 6 Case Studies at 22 At-Grade Crossings in San Diego

City	Location	Intersection Type	Presenting Problems	Improvements & Recommendations
Chula Vista	E St. at I-5 NB Ramps	Near Four-Legged Intersection	<ul style="list-style-type: none"> ▪ Excessive delays for E-W traffic on H St. during preemption 	<ul style="list-style-type: none"> ▪ VMS for Drivers ▪ 2nd Train Warning
	H St. at I-5 NB Ramps	Near Four-Legged Intersection	<ul style="list-style-type: none"> ▪ Excessive delays for E-W traffic on H St. during preemption 	<ul style="list-style-type: none"> ▪ Retime Woodlawn Ave. signal ▪ VMS for Drivers ▪ 2nd Train Warning
El Cajon	Marshall Ave. at Bradley Ave.	Isolated Crossing	<ul style="list-style-type: none"> ▪ Visibility restricted by buildings nearby the railroad 	<ul style="list-style-type: none"> ▪ Monitor location for incidents or violations
	Cuyamaca St. North of Weld Blvd.	Isolated Crossing	<ul style="list-style-type: none"> ▪ NB vehicle from Cuyamaca St. back-up on near the tracks ▪ Excessive delays from crossing of SB LRV ▪ Accidents on NB Cuyamaca St. at the crossing 	<ul style="list-style-type: none"> ▪ Modified advanced warning sign ▪ Adaptive traffic signal phasing ▪ Preemption setup modification
La Mesa	Severin Drive at Amaya Drive	Near Four-Legged Intersection	<ul style="list-style-type: none"> ▪ Speeds and stopping sight distance ▪ Access to Campina Drive 	<ul style="list-style-type: none"> ▪ Enhance pavement markings ▪ Flashing beacon ▪ Restrict access from Campina Drive

²⁹ Katz, Okitsu & Associates, Highway-Rail At-Grade Crossing Study, May 2002

			restrict clearance of vehicles from tracking during preemption	<ul style="list-style-type: none"> ▪ Extinguishable message sign for SB Amaya Drive
	Spring St. at University Ave.	Near Four-Legged Intersection	<ul style="list-style-type: none"> ▪ High volume of traffic and long delays during preemption ▪ Difficult to maintain traffic signal coordination with multiple preemptions 	<ul style="list-style-type: none"> ▪ Adaptive traffic signal phasing ▪ Retime existing signal during normal operation
Lemon Grove	Lemon Grove Ave. at Broadway	Near Four-Legged Intersection	<ul style="list-style-type: none"> ▪ Excessive delays for EB and WB movements during multiple preemptions ▪ Pedestrian safety 	<ul style="list-style-type: none"> ▪ Interconnect signals on Broadway and with signal at Lemon Grove Ave. / North St. ▪ 2nd train warning ▪ Enhance signage for pedestrians
	Lemon Grove Ave. at North Ave.	Near Four-Legged Intersection	<ul style="list-style-type: none"> ▪ Storage for NB Lemon Grove Ave. and for SB North Ave. 	<ul style="list-style-type: none"> ▪ Adaptive traffic signal ▪ Signal interconnection /coordination ▪ Provide an exclusive SB right turn lane
National City	24 th St. at Harrison Ave. (Marina Way)	Near Four-Legged Intersection	<ul style="list-style-type: none"> ▪ No interconnection of new signal to freight train crossing 	<ul style="list-style-type: none"> ▪ Interconnect new signal to rail line
	Broadway at Kettner Blvd.	Near Four-Legged Intersection	<ul style="list-style-type: none"> ▪ Conflict between pedestrians and clearing vehicles ▪ Pedestrian movement prohibited on all legs ▪ Multiple preemptions cause backups 	<ul style="list-style-type: none"> ▪ Re-phase/retime signal, include “Pedestrian scramble” phase ▪ Adjust clearance time for vehicles

San Diego			on WB Broadway	
	Harbor Drive at Market St.	Near Four-Legged Intersection	<ul style="list-style-type: none"> ▪ Congestion due to poor progression with multiple preemptions 	<ul style="list-style-type: none"> ▪ Adaptive traffic signal phasing ▪ Update/improve pavement markings ▪ Pre-signal for WB traffic on Market Street ▪ Retime signal during normal operations
	Harbor Drive at Front St.	Side Street Running with Near Cross Streets	<ul style="list-style-type: none"> ▪ High volumes of pedestrians crossing Harbor Drive ▪ Congestion due to poor progression with multiple preemption 	<ul style="list-style-type: none"> ▪ Update/improve pavement markings indicating tracks on Front St. ▪ Retime signal for normal operations
	Harbor Drive at First Ave.	Side Street Running with Near Cross Streets	<ul style="list-style-type: none"> ▪ High volumes of pedestrians crossing Harbor Drive ▪ Congestion due to poor progression with multiple preemptions 	<ul style="list-style-type: none"> ▪ Extinguishable message sign on WB Harbor Drive ▪ Retime signal for normal operations
	Harbor Drive at 32 nd St.	Separated Tracks	<ul style="list-style-type: none"> ▪ Multiple sets of tracks and multiple preemptions cause excessive delay and confusion and congestion for motorists 	<ul style="list-style-type: none"> ▪ Re-phase/retime signal ▪ Adaptive traffic signal phasing ▪ VMS and/or 2nd Train Warning signs
Palm Ave. at Hollister St.	Near Four-Legged Intersection	<ul style="list-style-type: none"> ▪ Conflicts between pedestrians and clearing vehicles ▪ Short storage for queue on WB Palm Ave. 	<ul style="list-style-type: none"> ▪ Pre-signal on Palm Ave. ▪ Re-phase/retime signal for pedestrian scramble ▪ Provide for bus turnouts 	

			<ul style="list-style-type: none"> between tracks and Hollister St. ▪ Buses stop in travel lanes 	
Pacific Highway at Ash St.	Near Four-Legged Intersection		<ul style="list-style-type: none"> ▪ Multiple train preemptions during peak periods ▪ EB and WB traffic on Ash St. experiences long delays from multiple trains with multiple train operators 	<ul style="list-style-type: none"> ▪ Adaptive traffic signal phasing ▪ VMS for EB and WB traffic on Ash St. ▪ Re-phase/retime signal
Pacific Highway at Sassafras St.	Between Four-Legged Intersections		<ul style="list-style-type: none"> ▪ Visibility of pavement markings on Sassafras St. ▪ Insufficient clearance time for WB movements ▪ Excessive delays for EB and WB vehicles during multiple preemptions 	<ul style="list-style-type: none"> ▪ Enhance pavement markings ▪ Improve preemption setup and clearance timing
Taylor St. at Congress St.	Between Four-Legged Intersections		<ul style="list-style-type: none"> ▪ Excessive delays for EB and WB vehicles during multiple preemptions ▪ Traffic signal are not coordinated ▪ High pedestrian volumes 	<ul style="list-style-type: none"> ▪ Adaptive traffic signal phasing ▪ Improve preemption setup and clearance timing ▪ VMS and 2nd Train Warning signs
Friars Rd. at Napa St.	Diagonal Through Intersection		<ul style="list-style-type: none"> ▪ Unusual congestion conditions during Stadium events ▪ SB right turning traffic on Napa St. making illegal turns 	<ul style="list-style-type: none"> ▪ 2nd delayed gate timing strategy for special events ▪ Modify preemption clearance timing ▪ Secondary gate system for bicyclists ▪ VMS for drivers

			<p>during preemption</p> <ul style="list-style-type: none"> No crossing gates for bicyclists on bike path 	
	Euclid Ave. at Market St.	Near Four-Legged Intersection	<ul style="list-style-type: none"> Vehicle queues at Market St. and Naranja St. extend over tracks Lack of sufficient signage and pavement markings Long queues and delays caused by multiple preemptions and long gate closures 	<ul style="list-style-type: none"> Improve signage and pavement markings at crossing Re-phase/retime signals at Market St. and Naranja St. Improve preemption setup and clearance timing on Euclid Ave. at Market St. and Naranja St.
	Imperial Ave. at 65 th St.	Near Four-Legged Intersection	<ul style="list-style-type: none"> Motorists on 65th St. on tracks as LRV approaches 	<ul style="list-style-type: none"> Modify preemption sequence to begin clearance traffic before bell sounds
Santee	Cuyamaca St. at Mission Gorge Rd.	Isolated Crossing	<ul style="list-style-type: none"> LRVs must stop at traffic signal and await "T" indication Traffic signal mistimed Signal hardware/equipment vulnerable to damage 	<ul style="list-style-type: none"> Re-phase/retime signal Improve coordination of signals along Cuyamaca St. and Mission Gorge Rd. Provide geometric improvements to increase the capacity of the intersection VMS for operators

3. Field Data Collection System and Data Analysis

In order to explicitly understand the existing problems in the San Diego trolley system, a field data collection system was installed at some “problematic” intersections and some selected trolley trains. The data collection system consists of four major components. The data server collects data from three data sources and parses them into a MySQL database. The first data source is San Diego traffic management center (TMC). Traffic signal timing data from local BITrans 170 controllers is collected at the TMC and then sent to the central data server through VPN connection. The second data source is ten selected intersections where road tubes and traffic counters have been installed. Traffic volume data is stored in counter memory cards which need to be manually picked up. The last data source is five selected trolley trains. Two of the trains are equipped with PC-104 based data acquisition systems, which include a GPS receiver, a GPRS wireless modem and a computer. The computer logs train status data such as GPS data, trolley door status (open/closed), wheelchair lift status (stowed/deployed), etc. The logged data is transmitted to the central data server via GPRS every four hours. The other three trains are equipped with simpler data acquisition systems which can only record train GPS data. The traffic control data and traffic volume data collected are used for the simulation study, which is discussed in a later section. This section focuses on the analysis of the GPS data collected from the trolley trains along the “L” shaped segment formed by the two corridors (C Street and Park Boulevard) as shown in Figure 8.

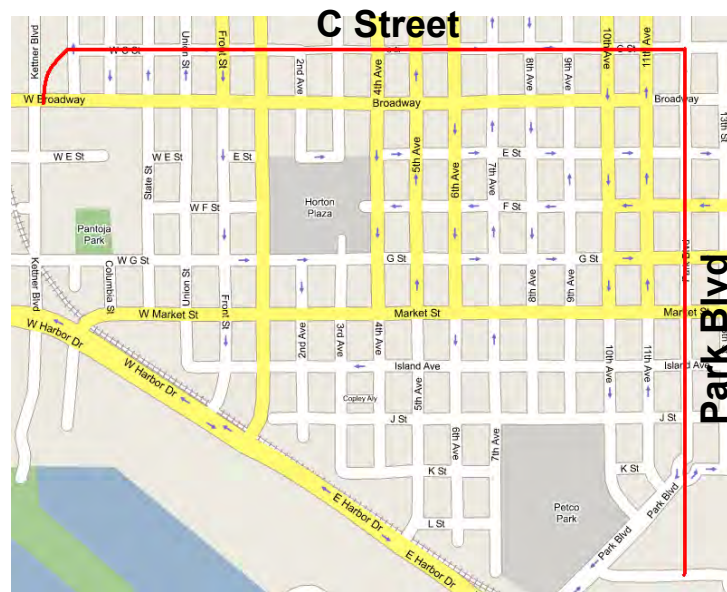

Figure 8 Study area map

The “L” shaped segment of trolley service covers a stretch of about 2660 meters (1.6 miles) through San Diego downtown area. It includes six trolley stations and 29 intersections. The scheduled trolley running time is 720 seconds from the arrival at the first station to the arrival at the last station.

Figure 9 shows a typical northbound (from Imperial Ave Station to America Plaza Station) trip trajectory. The origin of the coordinates is set at the Imperial Ave

Station. Trolley speed is represented by the dark line in the figure. The locations of both stations (represented by “o” in the figure) and intersections (represented by “x” in the figure) are labeled in the figure. The stop time of each trolley stop (station stop and non-station stop) is marked with a “◇”. The actual travel time for this specific trip is 854 seconds and about 2 minutes behind schedule. Such trolley operation delay comes from two sources: delay at the stations and delay during trolley movement. As shown in Figure 9, the trolley made five stops between stations during this trip in addition to the six station stops. The total stop time for these five additional stops is about 78 seconds.

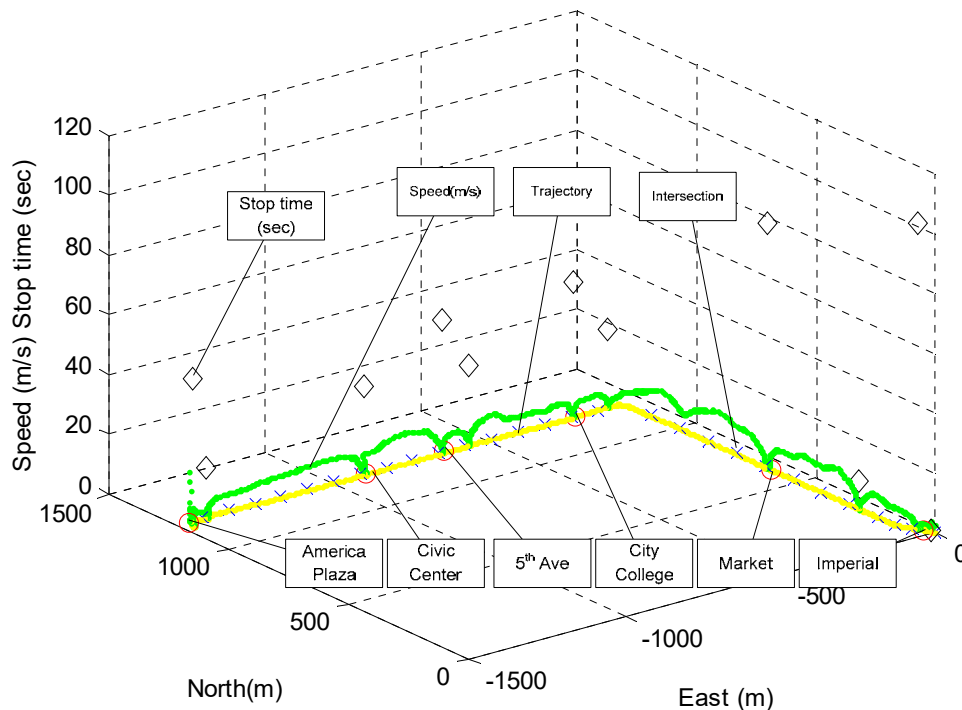

Figure 9 A trolley northbound trip trajectory

Schedule adherence is an important performance measure for public transit.

Figure 10 shows the amount of delay at each station for 45 northbound trips and 60 southbound trips compared with operation schedule (negative numbers mean early arrivals at the stations). Following observations can be made from Figure 10:

- 1) For southbound trips, the station arrival time variation is about 7 minutes;
- 2) For northbound trips, the station arrival time variation is much larger than that of southbound trips. This may due to two reasons: one is that the downtown section is much closer to the origin of southbound trips, thus northbound trains might have already accumulated higher delays when they enter the downtown area; the other reason might be the more frequent southbound trains during peak period.

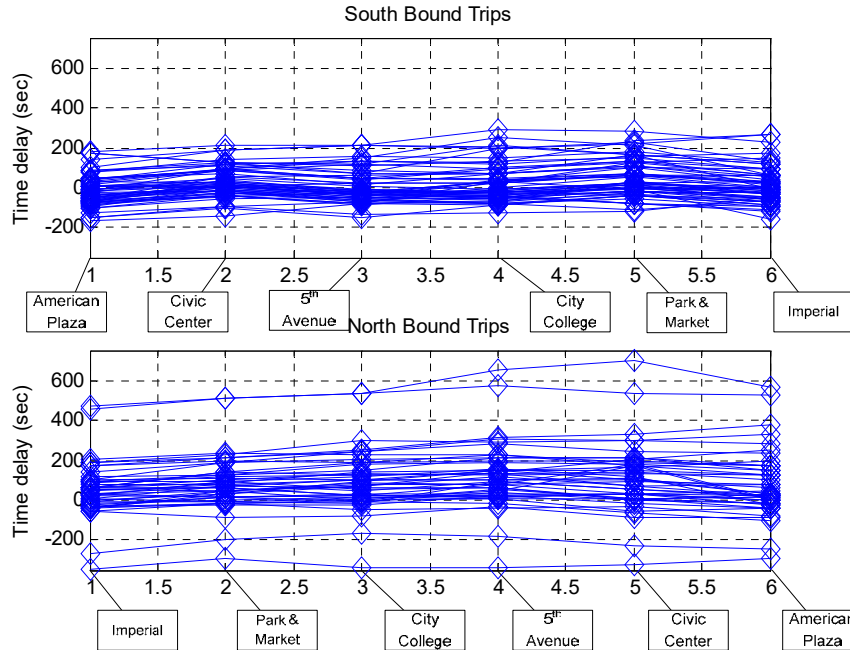
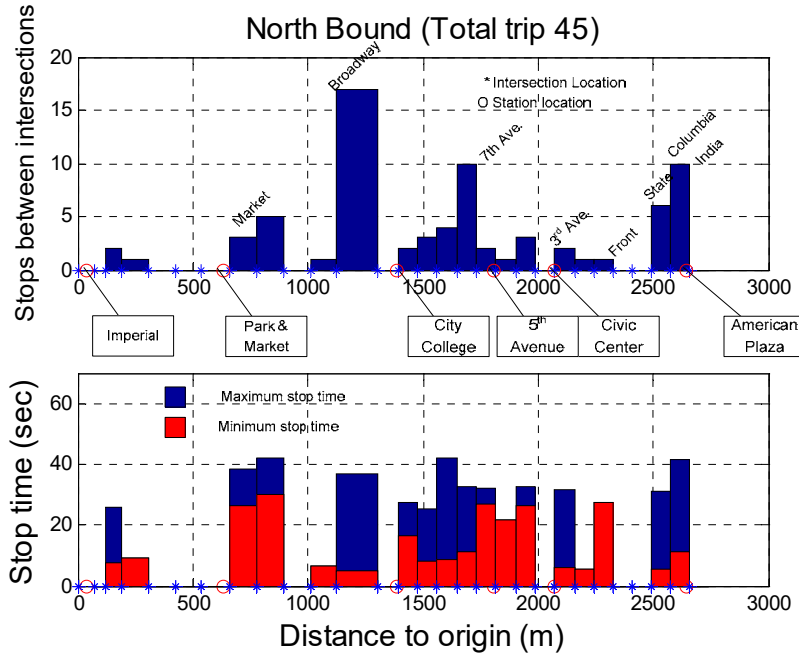

Figure 10 Schedule adherence

Frequent non-station stops are one major reason for the large station arrival time variations. To study the impact of the trolley non-station stops, the same data sets are analyzed in detail. For each trip, the trolley stops about 2.3 times in addition to the six station stops and the average non-station stop time per trip is about 40 seconds, which does not include the acceleration and deceleration time for each non-station stop. The analysis is also carried out for different intersections. Figure 11(a) and Figure 11(b) show the histogram and maximum/minimum stop time of non-station stops between intersections. For the convenience of illustration, the distance of intersections and stations to the origin (Imperial Ave Station) is used as the x-axis. Both Figure 11(a) and Figure 11(b) show quite frequent non-station stops with large stop times between trolley stations. Such frequent non-station stops can be classified into the following three categories:

- 1) The delay at upstream stations and trolley movement will disrupt the existing synchronization between the signal cycle and trolley movement. Trolley has to wait at the intersection for the next green cycle;
- 2) When the downstream trolley station is occupied by another trolley, the incoming trolley has to wait at the intersection upstream from the occupied trolley station;
- 3) Construction around the turning point of the “L” shape frequently slows down trolley movement. This could explain frequent stops before the Broadway intersection.



(a) Stops between stations for north bound trips

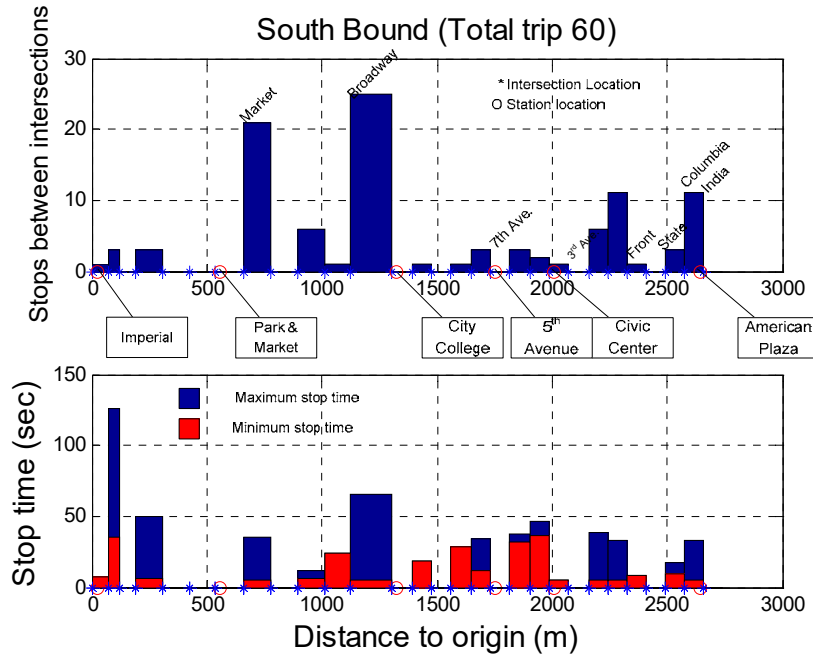

(b) Stops between stations for south bound trips

Figure 11 Number and length of train stopping

4. Trolley Movement and Dwell Time Prediction

An active LRT priority system is proposed to address the two categories of system problems. With better detection and prediction of train movement time and dwell time at stations, a series of “optimized” and specially designed signal timings could better synchronize LRT movements with traffic signals. Moreover, a better synchronization of each LRT train movement could relieve the train bunching problems. There are four major components in the proposed active LRT priority system: train detection component, travel and dwell time predictor, priority request generator, and the signal control component. The means of train detection can be either traditional point detection, such as loop detectors, or continuous detection, such as GPS based AVL systems. Different from most existing transit priority studies, the developed priority request algorithm does not focus on isolated intersections. Instead, it divides train routes into several independent sections, each of which starts from a station and ends at the downstream station. The intersections between two adjacent stations belong to one section. The proposed algorithm optimizes signal timings for each section in order to minimize train delay in between.

The signal control algorithm starts from the update of train detection. If the detected train is running late, both travel and dwelling time predictors would start to work and predict the Time to Arrival (TTA) at the downstream section. If no existing priority request has been placed for the current train, the signal optimization model would obtain current signal timings for those intersections in the next section and optimize their timings based on the predicted TTA. At the end, the priority request which consists of the timings for the next section would be sent to signal controllers.

The TTA predictor, which consists of travel time and dwelling time predictors, plays a crucial role in the priority system. If the TTA prediction error is big, the timing optimization model would squeeze a big part of green from other traffic to provide a wide band for the train. However, the signal timing optimization model can only provide a limited bandwidth for LRT trains. So an inaccurate TTA prediction would not only incur high delay for other traffic but also result in a high expected delay for the train itself. The following two sub-sections will specifically discuss the development of the trolley movement predictor and dwell time predictor.

4.1 Trolley Movement Prediction

PATH’s bus travel time prediction algorithm presented in the literature review section is implemented for the trolley travel time prediction. Simulation is performed with the collected data to show its effectiveness. The actual travel time is also calculated for the purpose of comparison. The prediction result of a south bound trip is shown in **Figure 12-12(a)**. The largest prediction error is around 17 sec throughout the whole trip. Large prediction error usually shows up when trolley starts to leave the station. At this moment, the trolley speed is very slow. Therefore the adaptive model does not pick up the right average speed and the arrival time prediction is based mostly on the historical model. When the trolley accelerates to its cruising speed, the adaptive model will provide the matching speed estimation and the prediction error will converge. To show the

consistency of the prediction algorithm, simulations are running for the data collected from 28 southbound trips. The prediction results from 5th Ave Station to City College Station are shown in Figure 12(b). For the purpose of the TSP algorithm, we are more interested in the prediction error when trolley is about 40 seconds before its next stop. The results show an average -7.65 seconds prediction error when trolley is about 40 seconds before City College Station with standard deviation of about 2.89 seconds.

Extensive simulation results prove that the original travel time prediction algorithm designed for bus is suitable for the trolley travel time prediction application.

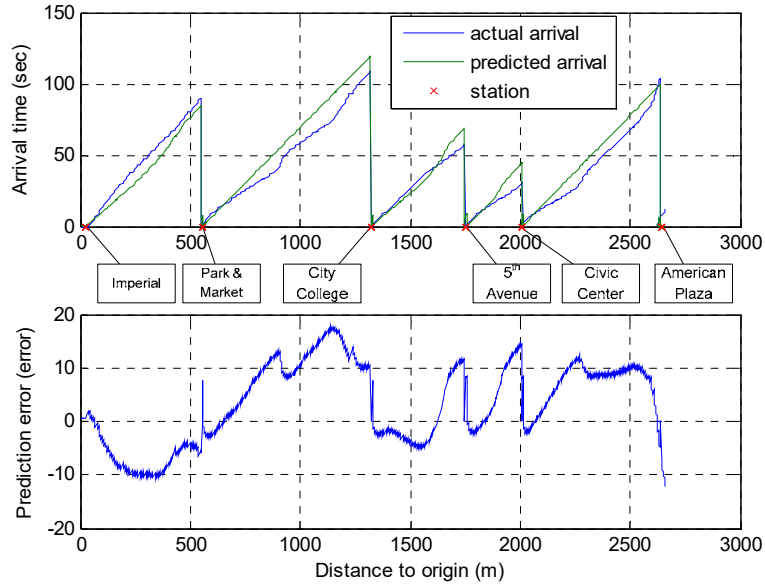

(a) Arrival time estimation for a southbound trip

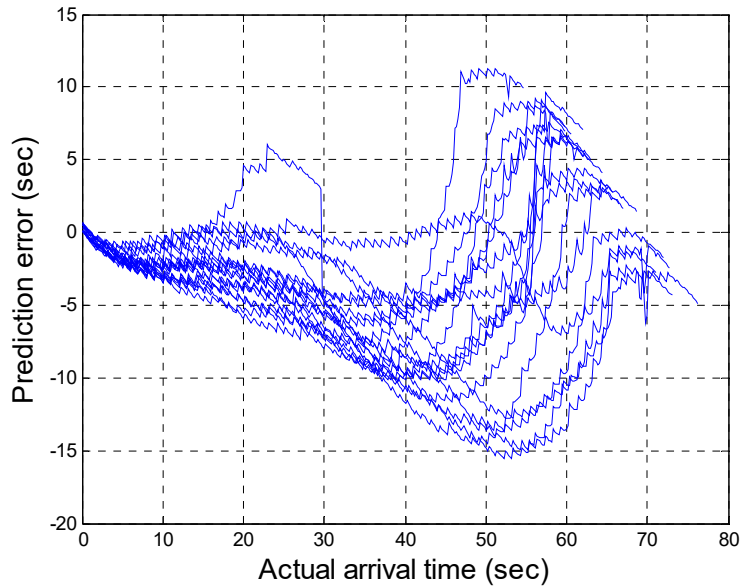

(b) Time-to-arrival estimator performance for city college station (southbound trip)

Figure 12 Trolley movement prediction performance

4.2 Dwelling Time Prediction

4.2.1 Dwelling time observation

As mentioned before, the GPS data collection device records the trains' door open/close status, from which the dwell times at stations are calculated. Figure 13 is the plots of station dwelling times at the four stations along the "L" shape downtown route for inbound and outbound trips, respectively.

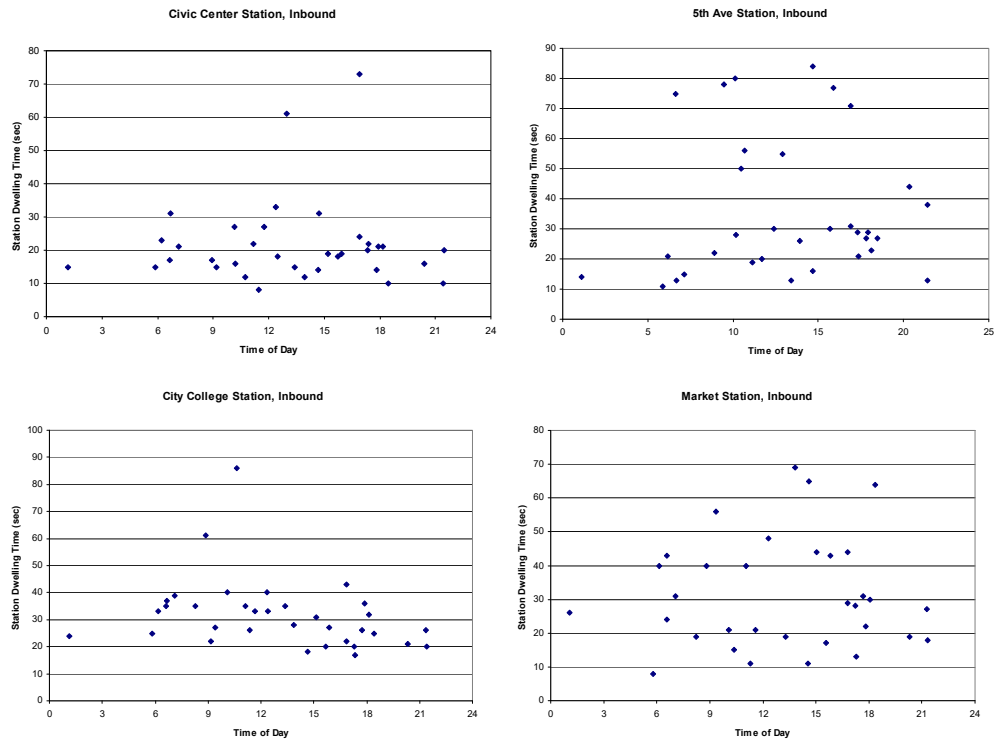

(a) Northbound trolley station dwelling times

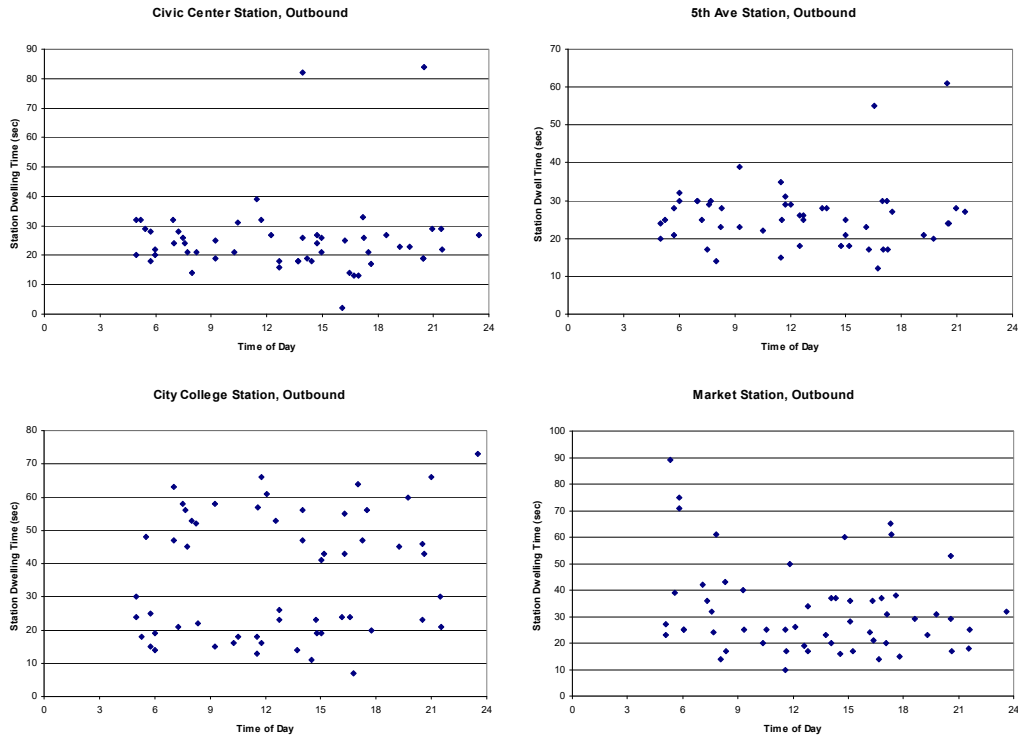

(b) Southbound trolley station dwelling times
Figure 13 Station dwelling time

As shown in the Figure 13, the dwell times do not show an obvious time of day pattern, although the passenger activity data obtained from the survey show definite time of day patterns (see Figure 14) – for instance, the inbound passenger counts drops significantly after 14:59, and the outbound counts shows an obvious peaking around 14:00 and drops rapidly after 19:00.

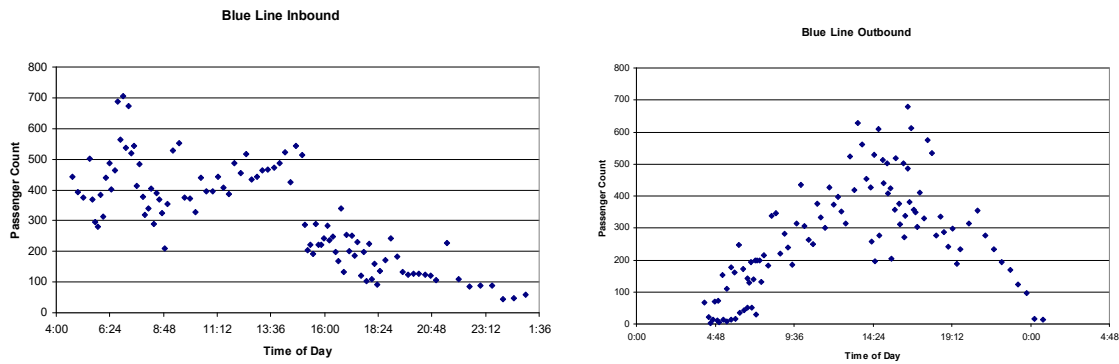

Figure 14 Historical passenger count from survey data

It seems unreasonable that the station dwell times do not reflect changes in passenger activities; however, note that since the trolley operation requires that after stopping at a station, the trolley trains do not depart the station unless the signal is within the first five seconds of the green phase, the train operator may leave the door open while waiting for

the traffic signal, thus the dwelling times obtained from door open/close status do not correspond well with the passenger boarding/alighting activities.

4.2.2 Dwelling time prediction

The TSP system requires an estimation/prediction of station dwelling time, so that the arrival time at downstream intersections can be predicted. Because the trolley trains are not equipped with APC, real-time passenger boarding/alighting numbers are not available and thus can not be relied upon for dwell time prediction purposes. Furthermore, for downtown train stations, dwell times obtained from the GPS door open/close status are not reliable. Based on these two reasons, dwell time data from stations that are outside of the downtown area, together with historical passenger count information, is used to build the prediction model. This section describes the model estimation procedure.

4.2.3 Data used for model estimation

Outside the downtown area, light rail and highway intersections are gate protected. The trolley trains can close the doors and leave the station as soon as the passenger boarding/alighting is completed. Thus the obtained dwelling times better reflect the time needed for passenger activities. Data from three stations located outside the downtown area is used: Barrio Logan Station, H Street Station, and Palomar Street Station.

Passenger activity information is obtained from previous survey data, which provide for each station the number of boarding and alighting passengers for four different time periods of the day (AM, Mid-Day, PM, and Other).

Dwell time data at the three stations for both inbound and outbound trips are available for individual trips. However, since we are using previous survey data for passenger activities, it is not reasonable to try to correspond those two sets of data at a detailed trip level. Instead, the model will be estimated based on the averages for each time period of the day.

The number of data points available for model estimation is $3 \text{ stations} * 2 \text{ directions} * 4 \text{ time periods} = 24$ and Table 7 lists the raw data used for model estimation.

Table 7 Dwelling Time Data

			Boarding	Alighting	Average Observed Dwelling Time
Barrio Logan	NB	AM	103	98	16.33
		Mid-Day	163	164	17.11
		PM	63	62	16
		Other	53	135	16.5
	SB	AM	39	32	12
		Mid-Day	219	195	13.67
		PM	126	95	11.5
		Other	57	81	10.57
H St	NB	AM	589	827	29.82
		Mid-Day	597	739	20.44
		PM	280	269	27
		Other	341	244	22.03
	SB	AM	126	270	31.001
		Mid-Day	835	627	17.6
		PM	625	522	12
		Other	267	261	17.63
Palomar	NB	AM	526	648	26
		Mid-Day	615	740	26.04
		PM	336	315	35.35
		Other	360	297	23.28
	SB	AM	137	239	26.17
		Mid-Day	650	696	19.35
		PM	576	599	25
		Other	252	303	20.25

4.2.4 Dwelling time model estimation

The dwelling time model to be estimated is of the following form:

$$T_d = T_o + T_c + A_a N_a + A_b N_b$$

where T_o is door open time (2 seconds);

T_c is door clearance time (8 seconds);

N_a, N_b are the highest number of alighting and boarding passengers at the door, respectively. A trolley train typically has 12 doors that serve both boarding and alighting passengers. For boarding, if there are only few passengers at a station, they will probably not be uniformly spreading over all 12 doors. Instead, it is assumed that at least one door will get more passengers and that door will dominate the dwelling time.

A_a, A_b are the per passenger alighting and boarding time, respectively, and are the parameters to be estimated.

Multi-variable linear regression is used for the estimation and the result is:

$$A_b = 2.97 \text{ seconds/person}$$

$$A_a = 2.66 \text{ seconds/person}$$

Figure 15 plots the calculated dwelling time v. the observed dwelling time. The model's R square value is 0.81 (adjusted R square is 0.76), with standard error of 5.66 and both parameters statistically significant at 95% confidence level.

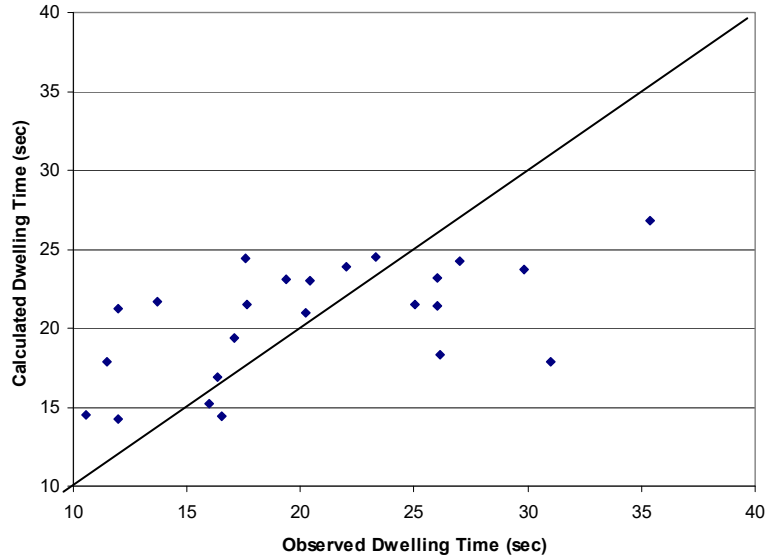

Figure 15 Observed vs. calculated dwelling time

5. The Proposed Active Signal Priority System

The proposed active LRT priority system consists of four major components: train detector, train travel and dwelling time predictor, priority request generator, and traffic signal controllers. The train detection means can be either traditional point detection, such as the loop system, or continuous detection, such as the GPS based AVL system.

The priority request generator is the “brain” of the proposed priority system. A train route is divided into several independent sections, each starting from a station and ending at the downstream station. The intersections between two adjacent stations belong to one section. Within each section, three priority schemes based on train schedule adherence are designed as below:

- When a train is running late, for example three minutes behind its schedule, scheme I with a timing optimization model, which will be particularly described in the following section, will be applied.
- When a train is running early or on-time, scheme II with two 5-second-bands starting from 3rd Ave. and 5th Ave. respectively is applied.
- When there is no train approaching in the next cycle, only the minimum green for pedestrians is provided along the trolley direction.

Scheme II and III are rule based signal control algorithms which can be implemented by two sets of fixed-time signal plans. When the two schemes are triggered, the priority request generator loads the right signal plan on signal controllers. While for scheme I, as shown in **Figure 16**, the priority request generator will predict the time-to-arrival (TTA) at the downstream section through a travel time predictor and a dwelling time predictor. The two predictors are developed separately under the SDT project. If no existing priority request has been placed for the train, a signal timing optimization model, which will be detailed in the following section, will obtain current signal timings for intersections in the next section and optimize the timing plans based on the predicted TTA. At the end, the priority request generator would send optimized timing plans to the signal controllers in the downstream section.

5.1 Signal Timing Optimization Model

The objectives of this optimization model are two-fold: 1) to minimize intersection delays for trolleys by providing signal priority; and 2) to minimize impacts on other traffic incurred by the priority. Unlike existing signal priority studies which typically focus on isolated intersections, the proposed model deals with multiple intersection signal timing plans that provide an optimized green band for an incoming train. The optimized green band would start at the right time to cover the predicted train TTA and should be wide enough to accommodate prediction errors. The proposed model adjusts green bands by changing signal offsets and green lengths.

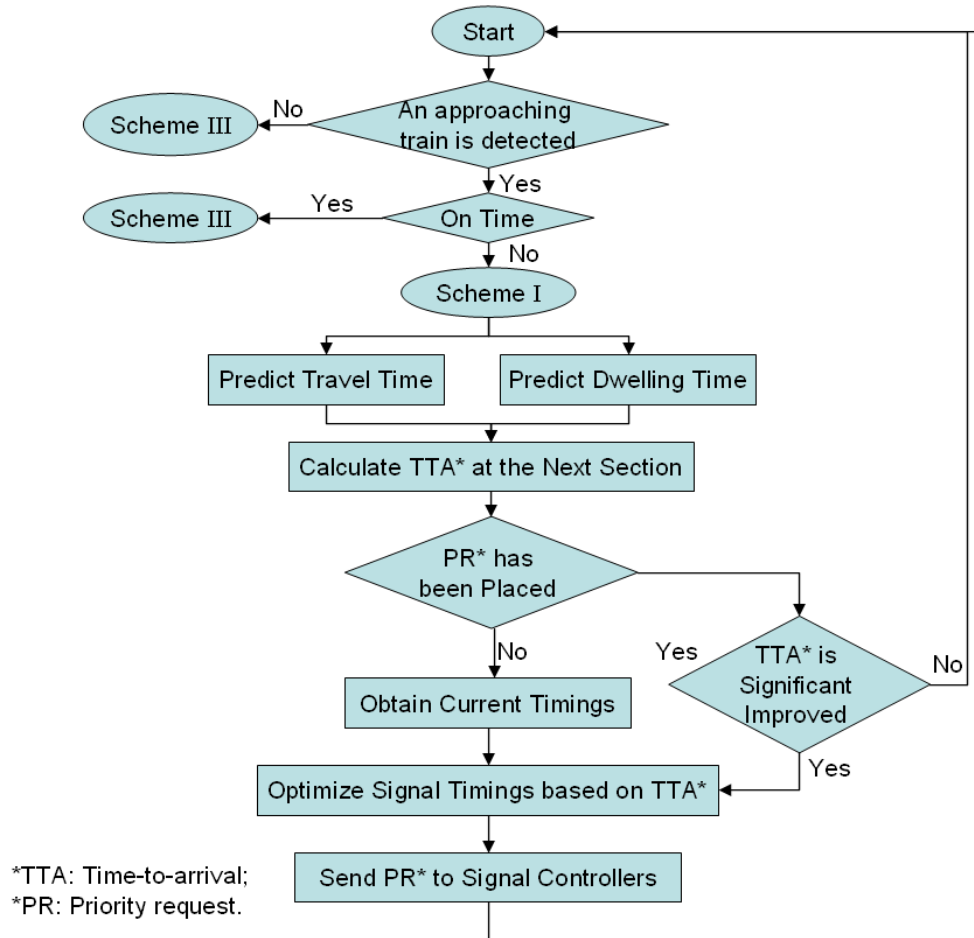

Figure 16 Flow chart of priority request generator

Figure 17 illustrates the principle of the proposed model. Because of driver behaviors and other environmental factors, the train TTA at the first intersection of a section is a random variable. In the “before” scenario, the mean of TTA falls into the red phase, and accordingly, the area of “train delay free zone”, which represents the probability that TTA falls within the green band, is relatively small. The “after” scenario presents the situation with the optimized green band. The start of green is moved forward by Δ^{offset} so that the new green band from B_{start}^{after} to B_{end}^{after} covers a much bigger “train delay free zone” than that in the “before” scenario. As a result, the expected train delay is much smaller. Furthermore, for G^{after} , the duration of the new green phase for the train movement may be not so long as G^{before} facilitates the train movement. Thus, with a fixed cycle length, there is potential that the length of the green phase for cross traffic could be increased. Using a factor to put different weight on train delays against traffic delays, the model can limit the incurred traffic delays.

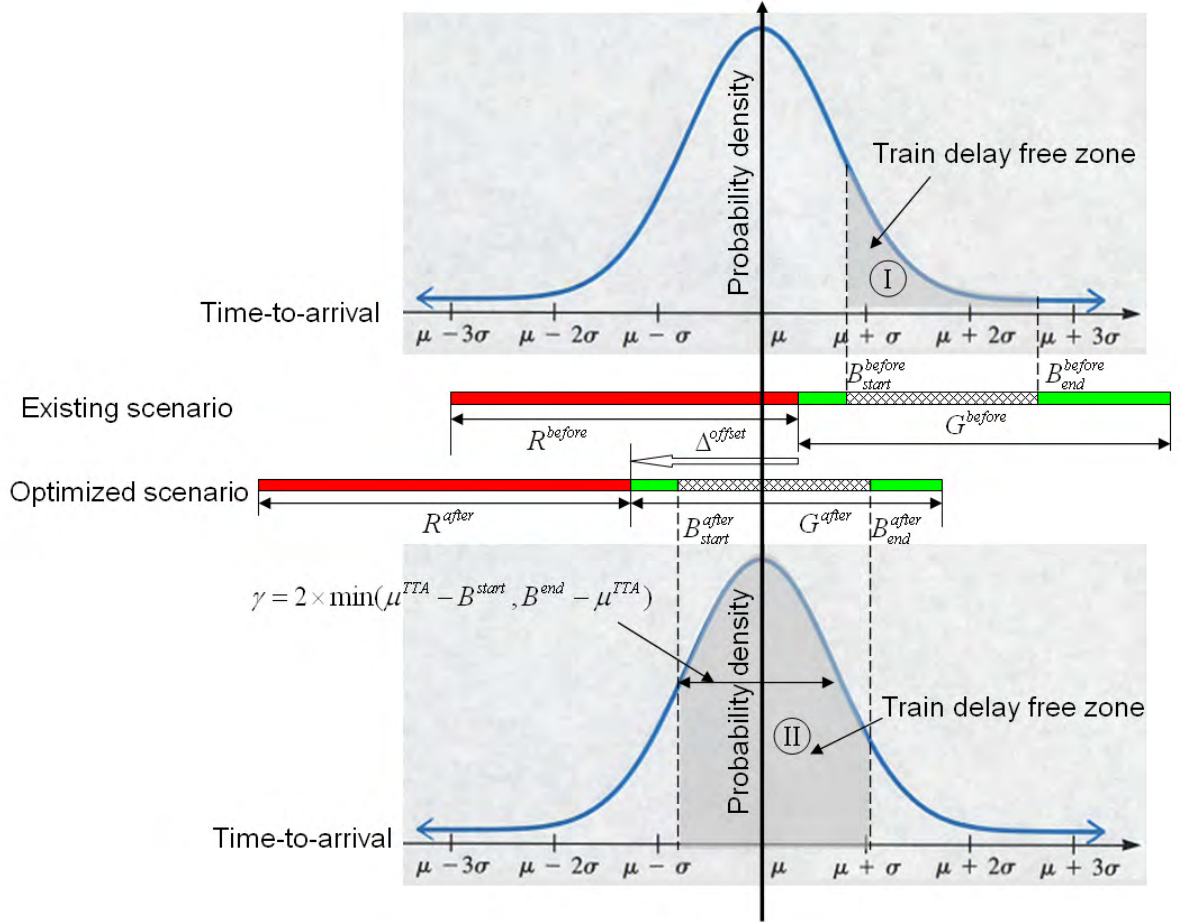

Figure 17 Principle of the proposed signal priority model

Equations (1)~(15) present a mixed-integer quadratic programming (MIQP) model. In the objective function, the first term is the total traffic delay. Traffic arrivals are assumed to be uniform. Following the aforementioned two-fold objectives, the second term should be the expected train delay, however, the mathematical programming problem will be extremely hard to solve if a statistical function is built into the objective function. Therefore, the buffer width within the green band that accommodates TTA prediction error, $\gamma = 2 \times \min(\mu^{TTA} - x_0, y_0 - \mu^{TTA})$, is used to represent the expected train delay in the objective function, and γ is inversely proportional to the train expected delay.

$$\text{Minimize } N_c \sum_{i=0}^N \sum_{j=1}^{M_i} \frac{\mu_{ij} \lambda_{ij}}{\mu_{ij} - \lambda_{ij}} \left(\frac{1}{2} R_{ij}^2 \right) - \omega \left(2 \times \min(\mu^{TTA} - x_0, y_0 - \mu^{TTA}) \right) \quad (1)$$

Subject to:

$$x_i = \frac{1}{S_0} (L_i - L_0) + x_0 \quad \forall i = 1, \dots, N \quad (2)$$

$$y_i = \frac{1}{S_0} (L_i - L_0) + y_0 \quad \forall i = 1, \dots, N \quad (3)$$

$$w_i = \frac{1}{S_1}(L_i - L_0) + w_0 \quad \forall i = 1, \dots, N \quad (4)$$

$$z_i = \frac{1}{S_1}(L_i - L_0) + z_0 \quad \forall i = 1, \dots, N \quad (5)$$

$$FDW_i + o_i - g_i + C \cdot n_{0i} \leq x_i, y_i \leq FDW_i + o_i + C \cdot n_{0i} \quad \forall i = 0, \dots, N \quad (6)$$

$$FDW_i + o_i - g_i + C \cdot n_{1i} \leq w_i \leq FDW_i + o_i + C \cdot n_{1i} \quad \forall i = 0, \dots, N - 1 \quad (7)$$

$$FDW_i + o_i - g_i + C \cdot n_{1i} \leq z_i \leq FDW_i + o_i + C \cdot n_{1i} \quad \forall i = 0, \dots, N \quad (8)$$

$$w_n = FDW_n + o_n - g_n + C \cdot n_{1n} \quad (9)$$

$$O_i - \Delta^{\max} + C \cdot n_{2i} \leq o_i \leq O_i + \Delta^{\max} + C \cdot n_{2i} \quad \forall i = 0, \dots, N \quad (10)$$

$$y_0 - x_0 \geq B_0^{\min} \quad (11)$$

$$z_0 - w_0 \geq B_1^{\min} \quad (12)$$

$$0 \leq o_i \leq C - 1 \quad \forall i = 0, \dots, N \quad (13)$$

$$G_i^{\min} \leq g_i \leq G_i^{\max} \quad \forall i = 0, \dots, N \quad (14)$$

$$n'_{js}, o'_i s, \text{ and } g'_i s \text{ are all integers. } \quad \forall i = 0, \dots, N, \text{ and } \forall j = 0, 1, 2, 3 \quad (15)$$

where, C : the cycle length;

ω : the weighting factor in the objective function;

N_C : the number of signal cycles impacted by the requested signal priority;

$N + 1$: the total number of intersections within the section;

M_i : the total number of traffic movements at intersection i ;

μ_{ij} : the cross street lane capacity at intersection i in the j -th movement;

λ_{ij} : the cross street traffic demand at intersection i in the movement j ;

R_{ij} : the red clearance time at the i -th intersection for the j -th movement;

μ^{TTA} : the mean of TTA;

x_i : the beginning of the band for the train of interest at intersection i ;

y_i : the end of the band for the train concerned at the i -th intersection;

w_i : the beginning of the band for the other bound at intersection i ;

z_i : the end of the band for the other bound at the i -th intersection;

L_i : the relative distance of intersection i w.r.t. a reference point;

S_0 : the speed of the train of interest, $S_0 > 0$;

S_1 : the speed of the train of the other bound, $S_1 < 0$;

o_i : the offset of intersection i w.r.t. the Master Clock after performance;

O_i : the offset of intersection i w.r.t. the Master Clock before performance;

FDW_i : the flash-don't-walk time at the i -th intersection;

g_i : the green length of intersection i along the train's direction;

Δ^{\max} : the maximum offset change within a signal cycle;

- G_i^{\min} : the minimum green length for g_i , i.e. the pedestrian walking time including the Flash Don't Walk time;
- G_i^{\max} : the maximum green length for g_i ;
- B_0^{\min} , B_1^{\min} : the minimum bandwidth for each of two bounds.

(2)~(5) represent the relationship between sides of the green bands with transit vehicle floating speed and intersection distances; (6)~(9) mean that the band should lie within the green phase, and particularly, (9) is a constraint specific to the San Diego trolley case and it provides the opposite bound train with a green band starting from the beginning of the green light at the first intersection of the same section; (10) guarantees the generated timing plans' applicability on existing signal control hardware. For 170 signal controllers in this study, the constraint is the maximum offset change within a short period of time; (11)~(12) are requirements for the minimum bandwidth for each direction; (13)~(14) are bounds for decision variables o_i 's and g_i 's, respectively.

The above model, which is labeled as the Scenario I model, deals with the cases when the green band from x_0 to y_0 can be moved to cover μ^{TTA} . However, the green band cannot always cover μ^{TTA} because of (10). For such cases, the Scenario II model, with two minor changes from the Scenario I model, is defined. The first change, as shown in (16), is on the second term of the objective function. In scenario II, the second term is the train waiting time at the first intersection of the section if the train arrives at μ^{TTA} . Moreover, for scenario II, the train has a good chance to wait for the start of green. To avoid a second stop in the section, the other change from the Scenario I model move the start of the green band for the train movement direction to the beginning of green at the first intersection, as shown in constraint (17).

$$\begin{cases} \text{scenario I : } -\omega(2 \times \min(\mu^{TTA} - x_0, y_0 - \mu^{TTA})) & \text{if } x_0 \leq \mu^{TTA} \leq y_0 \\ \text{scenario II : } \begin{cases} \omega(x_0 - \mu^{TTA}) & \text{if } \mu^{TTA} \leq x_0 \\ \omega(C - \mu^{TTA} + x_0) & \text{if } y_0 \leq \mu^{TTA} \end{cases} \end{cases} \quad (16)$$

$$x_0 = FDW_0 + o_0 - g_0 + C \cdot n_{00} \quad (17)$$

5.2 Case Study and Parametric Programming

The timing optimization model described above can be applied for TSP purpose at most signalized LRT and other transit crossings where transit has the exclusive or semi-exclusive right of way. For a better understanding and validation of the model, it is applied to a specific case.

As shown in Figure 18, a three-intersection-corridor between two San Diego trolley stations in the downtown area is selected as the study case. For the southbound Blue Line trip, a train departs from the upstream Civic Center station, crosses 3rd Ave., 4th Ave., and 5th Ave., and arrives at 5th Ave. station. The three intersections are controlled by BITrans

170 controllers in the coordinated fixed-time mode. There are only two phases for trolleys and traffic respectively in a fixed cycle. From 5 A.M. to 3 P.M., three signals run time-of-day pattern plan #2 with the cycle length of 70 seconds. The traffic along the train track is ignored in delay calculation because its volume is trivial.

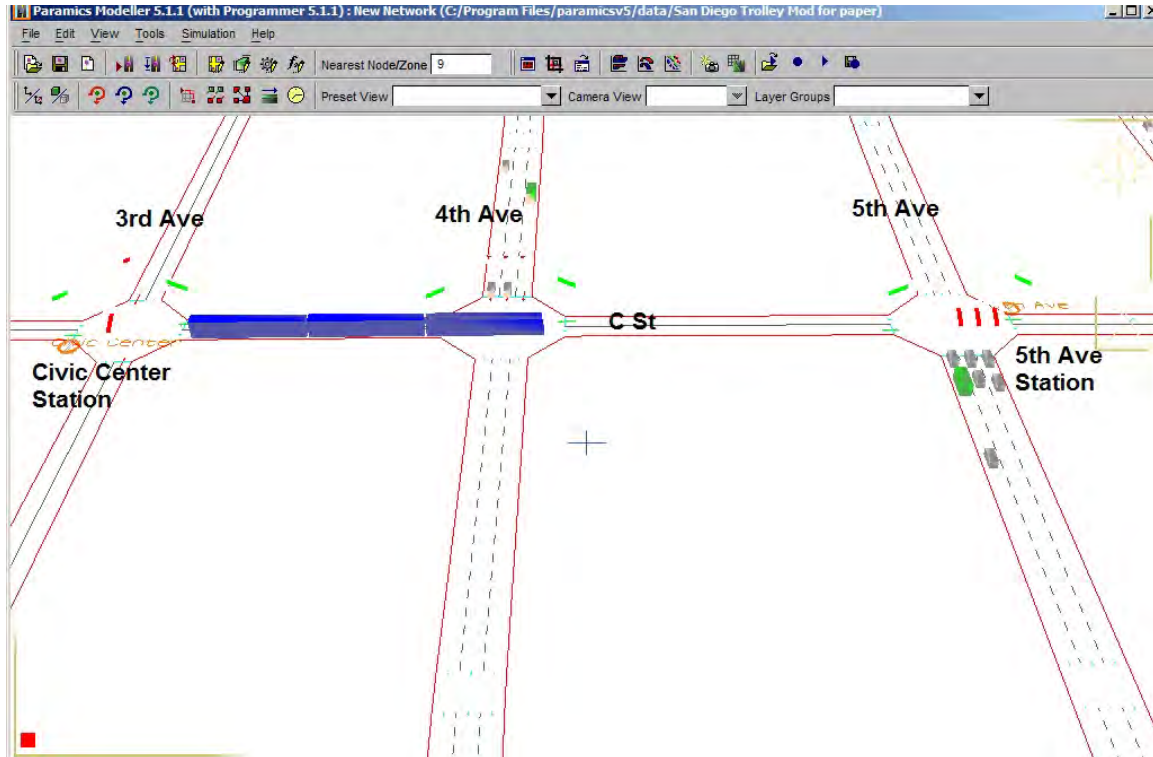

Figure 18 The case network at San Diego downtown area

As described in the previous section, bandwidths for transit approaches, instead of transit delays, are included in the objective function for the simplicity of the model and the ease of calculation. However, it is not appropriate to combine the bandwidth together with the traffic delay to measure the effectiveness of a signal priority model. Moreover, one of the major reasons to provide transit vehicles priority is that transit vehicles typically have much higher occupancies, thus TSP has the potential to reduce overall delay at intersections on a per person basis. Accordingly, the performance index (PI), which will be used to measure the model performance, is defined as the total intersection passenger delay. The passengers here refer to not only those on TSP favored transit vehicles but also those on other vehicles which are affected by TSP.

To reflect the statistical property of train TTA, as illustrated in Figure 17, the transit part of PI is the expected trolley passengers' intersection delay. The predicted TTA consists of two components: the trolley movement part and the station dwell part. Based on the analysis of a great amount of trolley movement data, it is observed that, without the disturbances of traffic signals and train stations, train travel time between stations is a normal alike random variable. According to the train movement data at the example site, the mean and standard deviation of train travel time at 318 meters upstream of 3rd Ave. is

40.6 seconds and 5.47 seconds, respectively. The standard deviation of dwelling time at 3rd Ave. station is 5.53 seconds. Assuming these two components of TTA prediction follow independent normal distributions, we calculate that the standard deviation of TTA is 7.78 seconds. According to the flow chart as shown in Figure 16, the priority request generator is triggered when a late train is 318 meters upstream of 3rd Street. Then given a predicted TTA and a set of original signal timings, the priority request model of Scheme I applies and generates a set of optimized signal timings. Finally, the expected trolley passengers' intersection delay can be readily obtained by multiplying the expected train delay by the average of on-board passenger number, which is 84, according to the SDT system-wide annual survey for the past five years.

For the part of PI that represents the impact on traffic, the first term of (1) depicts the total traffic delays within the TSP impacted cycles. Under the assumption that the average occupancy per vehicle is 1.2 passengers, the traffic passengers' intersection delay can be readily obtained.

In the proposed optimization model, some parameters, such as weighting factor ω and minimum bandwidth B^{\min} , are arbitrary constants. The performance of the model is also subject to the choices of such parameters. Thus the parametric programming is needed to further optimize the model objective over the arbitrary parameter space.

For the SDT case, the arbitrary parameter space has two dimensions, which are ω and B^{\min} . Given a combination of ω and B^{\min} , a set of optimal signal timings could be calculated based on a predicted TTA and the current signal timings. Assuming μ^{TTA} , the mean of TTA, follows a uniform distribution, the average PI for each parameter pair (ω, B^{\min}) can be calculated over $TTA \in [0, Cycle)$. As illustrated in Table 8, Figure 19, and Figure 20, the PIs along both of the two dimensions are convex. Thus the classic local search method can be applied to search for the best parameter combination.

Table 8 Model performance for different ω and B^{\min}

		ω	5	10	15	20	25	30	35	40	45	50
$B^{\min} = 5$	PI*	Mean	2033.3	1598.5	1350.4	1193.3	1228.5	1217.0	1219.7	1219.6	1218.2	1219.9
		Std*	357.2	677.0	667.8	570.7	555.6	538.9	539.3	539.0	539.3	539.8
$\omega = 20$	B^{\min}		3	5	7	9	10	15	20	25	27	30
	PI*	Mean	1197.1	1192.9	1180.7	1157.8	1149.7	1077.7	1020.4	973.9	1001.3	1010.0
		Std*	587.9	570.2	667.8	495.7	479.7	386.4	332.4	312.1	353.0	351.4

Note:

PI*: performance index;

Std*: standard deviation

As shown in Table 8 and Figure 19 for the particular three-intersection case, the minimum average PI, when applying the existing cycle length of 70 seconds, the original offsets, and $B^{\min} = 5$, is 1193.3 seconds. The best ω when $B^{\min} = 5$, is 20. Then moving along the dimension of B^{\min} at $\omega = 20$, the minimum PI, 973.9, is found when B^{\min} is 25

seconds, as shown in Table 8 and Figure 20. Therefore, with TSP based on the current signal timings, the optimal point on the arbitrary parameter space is (20,25).

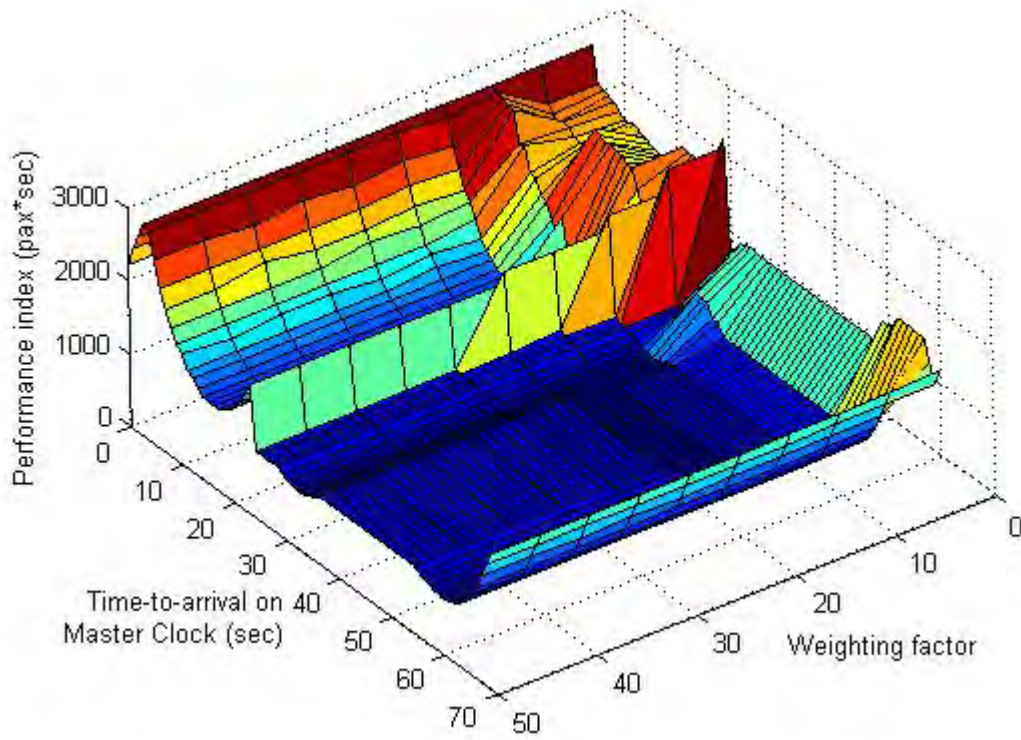

Figure 19 Model performance for ω from 5 to 50 and $B^{\min} = 5$

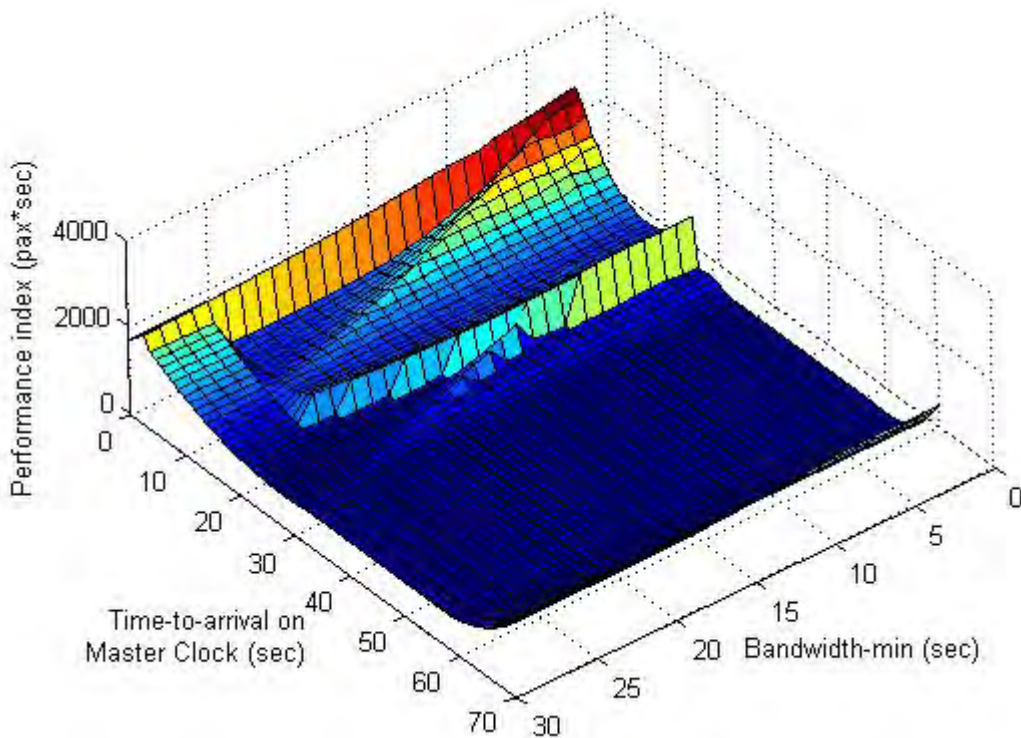

Figure 20 Model performance for B^{\min} from 3 to 30 and $\omega = 20$

Figure 21 compares the total PI, which consists of the transit delay and the traffic delay, for the optimized scenario and the existing scenario. In the existing scenario, the traffic delay is constant because of the unchanged red time for traffic at three intersections. The trolley delay in PI is the expected delay with respect to μ^{TTA} , σ^{TTA} , B_{start}^{before} , B_{end}^{before} , as shown in Figure 17. Obviously, the farther μ^{TTA} is from the band the higher the expected trolley delay will be. Nevertheless, the expected values are not symmetric to the center of the band because a trolley has to wait for a longer time when it just missed the band than when it arrived right before the band starts. As shown in Figure 21, the solid curve reaches its nadir at 44 while the band is from 49 to 56. Furthermore, the dotted curve is below the solid curve no matter where the TTA is on the master clock. It means the proposed optimization model performs stably better than the existing scenario whenever trains arrive.

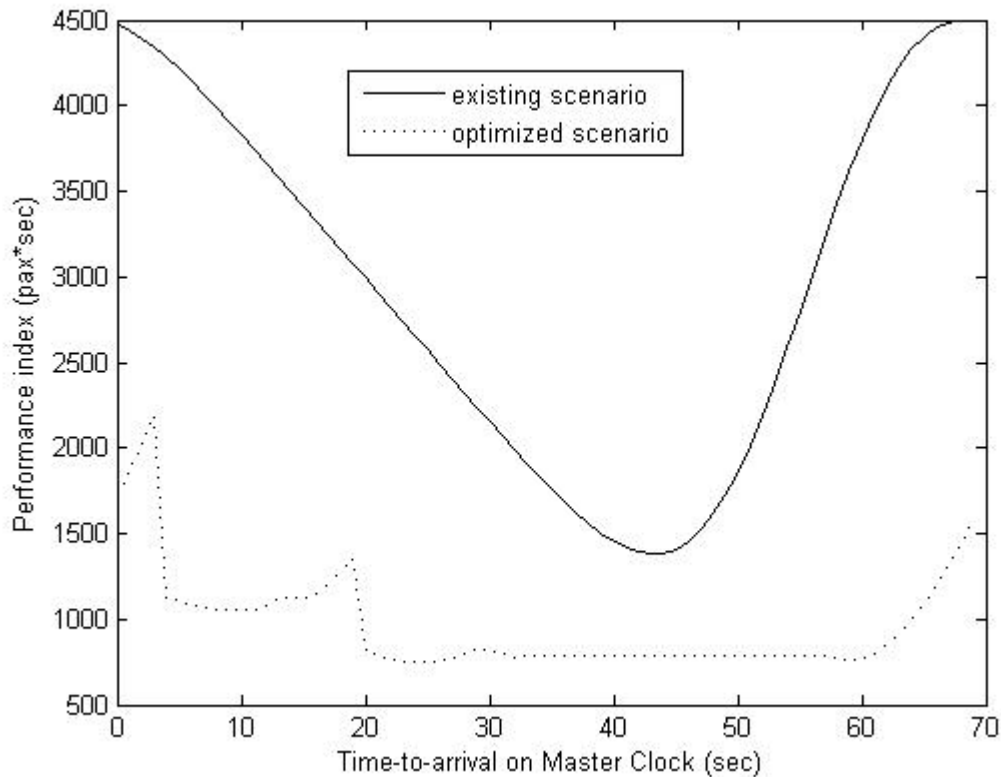

Figure 21 Comparison of PI for existing and optimized scenario

Table 9 compares the performance of three proposed signal priority schemes with the existing scenario. Scheme I is applied when a late train is approaching. In this case, signal priority is desired by the incoming train. By applying the proposed optimization model, the average trolley PI, which is the expected trolley passenger delay, is reduced enormously by **89.5%**. Moreover, the standard deviation of trolley PI is reduced significantly by 68.6%, which means trolleys' travel time is more stable with signal priority. Within the priority impacted cycles, the traffic delay is increased by 30.4%. So

each traffic vehicle that arrives in the priority cycle will wait for 4.1 more seconds in exchange with 25.3 seconds delay savings for the trolley. The total intersection passenger delay is reduced by **66.8%**. And its standard deviation is reduced by 70.8%. Scheme II is applied when an early or on-time train is approaching. For this scheme, a 5-second-band is provided for each bound of train travel directions and starts from the onset of green at the first intersection of the section. Thus trolley drivers can still follow the current rule and dwell at trolley stations till the beginning of the next green light at the first downstream signal. As long as the trolley leaves the station during the departure window, the train will receive green lights at all of the downstream signals till it reaches the next station. Furthermore, with the knowledge of time-to-arrival of the trains, the green band can be shifted more or less under the constraints of the signal controller, although the bandwidth is not quite large. From the table, we can see that the tighter but special designed band can save 32.5% of traffic delay (4.4 seconds per vehicle) for cross traffic and 67.4% of trolley delay (19.1 seconds per vehicle) at the same time,. Scheme III is applied when no train is approaching the section. In this case, only G_i^{\min} is provided for the direction of the train movement, so the traffic delay is minimized. The results show a 52% delay reduction from the existing scenario. The average traffic vehicle delay saving is 7 seconds. Based on the report from San Diego Trolley Inc. (SDTI), their on-time performance is higher than 90% in FY-2002, which means that a minority of trolley runs would require signal priorities. In such sense, Scheme I can keep most trains running on-time, and then Scheme II and Scheme III, which are applied more frequently than Scheme I, can provide lots of benefits to other traffic.

Table 9 Comparison of existing and optimized scenarios

		TROLLEY PI* (<i>pax</i> · sec)		TRAFFIC PI* (<i>pax</i> · sec)	TOTAL PI* (<i>pax</i> · sec)		VEHICLE DELAY (<i>veh</i> · sec)		
		Mean	Std*	Mean	Mean	Std*	Trolley	Traffic	
Existing Scenario	Measures	2381.4	1068.0	555.7	2937.1	1068.0	28.3	13.5	
Optimized	Scheme I*	Measures	249.1	335.7	724.8	973.9	312.1	3.0	17.6
		Change	(sec)	-2132.3	-732.3	169.1	-1963.2	-755.9	-25.3
	(%)		-89.5%	-68.6%	30.4%	-66.8%	-70.8%	-89.5%	30.4%
	Scheme II*	Measures	776.9	526.8	375.2	1152.1	526.8	9.2	9.1
		Change	(sec)	-1604.5	-541.2	-180.5	-1785.0	-541.2	-19.1
	(%)		-67.4%	-50.7%	-32.5%	-60.8%	-50.7%	-67.5%	-32.5%
	Scheme III*	Measures	0	0	266.6	266.6	N/A	0	6.5
		Change	(sec)	N/A	N/A	-289.1	N/A	N/A	N/A
	(%)		N/A	N/A	-52.0%	N/A	N/A	N/A	-52.0%

Note:

PI*: performance index;

Std*: standard deviation.

6. Simulation Study and Results

6.1 Station Dwell Time Prediction

The dwell time model estimated in the previous section is applied in the simulation study to estimate dwell times at stations within our study area. Again, since APC is not available for each time period, the numbers of boarding/alighting passengers at the stations are estimated from historical survey data. The dwell time model is then applied to obtain the average dwell time at the station. During the simulation, a trolley that arrives at a certain station during a certain time period will be assumed to dwell for the average time that is calculated for the specific station, time period, and direction of travel. A random term is added to the average time to account for variability. The random term is assumed to be normally distributed with mean of zero and standard deviation of 5.66.

6.2 Calibration of Simulation Model

PARAMICS, a popular microscopic traffic simulator, is used for the simulation study. The simulation model is built and calibrated using the collected data. When constructing the network, GPS coordinates are used to determine the exact location for each intersection. Road geometries, trolleys train specifications, signals timings, traffic demands and passenger demands are coded based on the information provided by SDTI and City of San Diego. Using PARAMICS application programming interface (API), the proposed signal control algorithm, trolley movement predictor, dwelling time predictor, and data collection and analysis tools are also programmed into PARAMICS. The dwelling time prediction model developed in the previous section is used to determine station dwelling time in the simulation.

To collect the movement data, many virtual detectors are placed in the simulation network. The numbers of trips available for comparison of field data and simulation

results are 169 and 170, respectively. The simulation model is calibrated against field observation using the following parameters: total travel time, aggregate travel speed, non-stop movement speed, and intersection delays.

The data obtained from field data as well as from the simulation are presented in Table 10. The relative total travel time differences between field observations and the simulation results are just 2.4% and 2.2% for southbound trips and northbound trips, respectively. Similarly, the difference in overall speed is also trivial. However, because of the complexity of actual situations (which results in more varied observation values) and the simplicity of the simulation model, the standard deviations do not match very well. Table 10 also shows the movement speed, which is the speed excluding station dwell time and the signal waiting time. It is observed that the relative differences for movement speed for southbound and northbound trips are 5.5% and 5.8%, respectively. As for the average intersection delays, the simulation results capture the trend displayed in the field data for far side intersections, although the values are not exactly the same.

Table 10 Comparison of field observation and simulation results

Data source		Field Observation		Simulation Results	
Direction		SB	NB	SB	NB
Total travel time (sec)	Mean	757.82	748.27	739.6	731.9
	SD	81.38	71.10	22.97	36.67
Overall speed (m/s)	Mean	3.81	3.84	3.86	3.88
	SD	0.54	0.55	0.11	0.21
Movement speed (m/s)	Mean	6.53	6.70	6.89	7.09
	SD	N/A	N/A	0.34	0.23

6.3 Simulation Results

After the simulation model is calibrated, the proposed active signal priority system is implemented in the simulation. To illustrate the improvement obtained by the proposed system, the existing trolley operation is first reproduced using the simulation model. The focus of analysis is the northern section of San Diego downtown area between 3rd Ave and 5th Ave. Under the current trolley and passive priority operation, of the totally 87 southbound trips during the period between 5:00 and 15:00 on a typical weekday, there are only six trips that travel through the above mentioned three intersections without any stops. However, when the proposed active system is implemented, 74 out of the 87 trips are without any stops at the three intersections. Further analysis shows that the prediction errors of arrival time, which is composed of errors in movement prediction and dwelling time prediction account for the other 13 trips. In addition, the predicted speed of the trolley is responsible for the simulation results. Obviously, the simulation results after optimization largely depend on the precision of the prediction. If the actual arrival time deviates too much from the predicted value or γ calculated from the model is too small, then the trolley will miss the green band and has to wait until the signal light turns green.

Table 11 shows the comparison results between the existing scenario and the optimized one obtained by simulation. The performance index (PI) for trolleys decreases by as much as 77% if we use the proposed signal control algorithm, although the PI of the cross street traffic increases by 27%. By adjusting the weighting factor in our MIQP model, we can reduce the delay for the cross street traffic, however, the time saved for trolley will not be so noticeable. Furthermore, the traffic PI is a constant in the existing scenario, but it may vary in the optimized case because the length of the green phase calculated by the algorithm might change with different arrival times.

Table 11 Simulation study results for existing and optimized scenarios

		Trolley PI* (<i>pax</i> · sec)		Traffic PI* (<i>pax</i> · sec)		Total PI* (<i>pax</i> · sec)		Vehicle Delay (<i>veh</i> · sec)		
		Mean	Std*	Mean	Std*	Mean	Std*	Trolley	Traffic	
Existing	Measures	2339.4	1631.6	555.7	N/A	2895.2	1631.6	27.9	16.2	
Optimized	Measures	546.1	1172.4	708.7	123.2	1254.8	1152.3	6.5	20.7	
	Change	(sec)	-1793.3	-459.2	153	N/A	-1640.4	-479.3	-21.4	4.5
		(%)	-76.7%	-28.1%	27.5%	N/A	-56.7%	-29.4%	-76.7%	27.5%

Note:

PI*: performance index;

Std*: standard deviation.

7. Summary

In summary, this report reflects those efforts that the team at PATH has taken for Task Order 5407 of this project. Keeping in mind the legislation corresponding to trains and signal operations at grade crossings, we did an in-depth and thorough literature review on time-to-arrival prediction, system evaluation and simulations as well as the existing grade crossing products and technologies.

By carefully examining the cases studied at grade crossings in San Diego and all the documents related to the San Diego trolley system, we employed simulation to explore potential solutions to perceived problems in the current trolley operation system in San Diego.

Based on what we found in the simulation, we installed our data collection systems at some “problematic” intersections and several selected trolleys. There are three data sources: the first one is San Diego traffic management center (TMC). Traffic signal timing data from local BITrans 170 controllers are collected at the TMC and then sent to the central data server through VPN connection. The second data source is ten selected intersections where road tubes and traffic counters have been installed. Traffic volume data are stored in counter memory cards which need to be manually picked up. The last is five selected trolley trains. Two of the trains are equipped with PC-104 based data acquisition systems, each of which includes a GPS receiver, a GPRS wireless modem and a computer. The computer logs train status data such as GPS data, trolley door status (open/closed), wheelchair lift status (stowed/deployed), etc. The logged data are transmitted to the central data server via GPRS every four hours. The other three trains are equipped with simpler data acquisition systems which can only record train GPS data.

After data were collected, several mathematical tools are implemented in data analysis. Some of the potential problems are then verified and more details in the operation of San Diego trolley system have been understood. Accordingly, the solution to the existing problem is proposed. Firstly, the movement time is predicted by use of Kalman filter and the predicted dwelling time is obtained from the multi-variable linear regression. Then, the time-to-arrival of the trolley at the first intersection of the section is available and the

signal timings of succeeding intersections are optimized to favor the operation of trolley. Combined with historical data in the database, such as the movement data of trolleys, the passenger on/off rates, etc., GPS data were made full use in both movement time prediction model, and the dwell time prediction model. With the knowledge of the intersection arrival time predicted, a Mixed-Integer Quadratic Programming (MIQP) model is proposed to minimize the expected trolley delays and the impacts on the cross street traffic simultaneously. The simulation results in PARAMICS fully illustrate the validity of the signal priority strategy that we proposed and also show that this strategy is a “win-win” one for both trolleys and general traffic.