



## **Caltrans Stormwater Quality Handbook Maintenance Staff Guide**

**CTSW-RT-18-314.20.1  
May 2018**

California Department of Transportation  
Division of Environmental Analysis, Stormwater Program  
1120 N Street  
Sacramento, California 95814  
<http://www.dot.ca.gov/hq/env/stormwater/>

For individuals with sensory disabilities, this document is available in alternate formats upon request.

Please call or write to:

Stormwater Liaison, Caltrans Division of Environmental Analysis  
MS 27, P.O. Box 942874, Sacramento, CA 94274-0001

(916) 653-8896 Voice or dial 711 to use a relay service.

## DISCLAIMER

*Any statements expressed in these materials are those of the individual authors and do not necessarily represent the views of CALTRANS, which takes no responsibility for any statement made herein. CALTRANS has not independently verified the results, conclusions or claims presented herein.*

*No reference made in this publication to any specific method, product, process, or service constitutes or implies an endorsement, recommendation, or warranty thereof by CALTRANS. The materials are for general information only and do not represent a finding of fact, standard of CALTRANS, nor are they intended as a reference in purchase specifications, contracts, regulations, statutes, or any other legal document. CALTRANS makes no representation or warranty of any kind, whether expressed or implied, concerning the accuracy, completeness, suitability, or utility of any information, apparatus, product, or process discussed in this publication, and assumes no liability therefore. This information should not be used without first securing competent advice with respect to its suitability for any general or specific application. Anyone utilizing this information assumes all liability arising from such use, including but not limited to infringement of any patent or patents.*

*In no event shall CALTRANS be liable for any direct, indirect, incidental, special, exemplary, or consequential damages (including, but not limited to, procurement of substitute goods or services; loss of use, data, or profits; or business interruption) however caused and on any theory of liability, whether in contract, strict liability, or tort (including negligence or otherwise) arising in any way out of the use of this software, even if advised of the possibility of such damage.*

*Copyright (2018) California Department of Transportation*

*All Rights Reserved*





# Table of Contents

List of Figures.....	ii
1. Introduction.....	1-1
1.1 Maintenance Staff Guide Purpose and Scope.....	1-1
1.2 Regulatory Background .....	1-1
1.2.1 Caltrans National Pollutant Discharge Elimination System Permit .....	1-3
1.2.2 Statewide Stormwater Management Plan .....	1-3
1.3 Roles and Responsibilities .....	1-4
1.4 Maintenance Staff Guide Organization .....	1-7
2. Objectives of Maintenance Stormwater Management Program .....	2-1
2.1 General Objectives of the Program.....	2-1
2.2 Pollutants of Concern for Highway Maintenance Activities and Facilities.....	2-3
2.2.1 Petroleum Products .....	2-3
2.2.2 Sediment .....	2-3
2.2.3 Trash/Litter.....	2-3
2.2.4 Metals .....	2-4
2.2.5 pH .....	2-4
2.2.6 Nutrients.....	2-4
2.2.7 Pathogens.....	2-4
2.2.8 Pesticides (including Herbicides).....	2-4
2.2.9 Other Pollutants .....	2-5
2.3 Incorporation of Best Management Practices into Maintenance Programs and Activities.....	2-5
2.4 Feedback Process.....	2-6

Appendix A: Acronyms and Definition of Terms

Appendix B: Activity Cut-Sheets

Appendix C: Maintenance BMPs

## List of Figures

---

Figure 1-1. Map of California with Regional Water Quality Control Boards and Caltrans Districts Boundaries .....	1-2
Figure 1-2. Maintenance and Operations Stormwater Management Program Functional Relationships.	1-5
Figure 2-2. Best Management Practices Questionnaire .....	2-7
Figure 2-3. Feedback Process .....	2-8

## Section 1

# Introduction

## 1.1 Maintenance Staff Guide Purpose and Scope

The California Department of Transportation (Caltrans) - Division of Maintenance (Maintenance) developed the Stormwater Quality Handbook – Maintenance Staff Guide (Staff Guide) as an employee handbook for the protection of water resources. The Staff Guide provides detailed instructions on applying the approved Maintenance stormwater Best Management Practices (BMPs) to Maintenance facility operations and highway activities.

For each Maintenance operation or activity, multiple approved Maintenance BMPs may be applicable. Because it may be impractical to review all the potentially applicable BMPs for each operation or activity, Activity Cut-Sheets were developed in a user-friendly format for common Maintenance facility operations and highway activities that have a potential to affect stormwater quality. Each Activity Cut-Sheet summarizes the approved Maintenance BMPs that may be applied to the operation or activity. It is not the intent of the Staff Guide to provide Activity Cut-Sheets covering all the Maintenance operations and activities.

The intent of the Staff Guide is to aid the user in understanding and applying the approved Maintenance BMPs. The user has the option of using the Activity Cut-Sheets in the Staff Guide (Appendix B) or using only the approved Maintenance BMPs (Appendix C). The Staff Guide is an employee handbook which contains approved Maintenance BMPs for use by Caltrans.

To update and establish new approved BMPs, Section 2.5 of the Feedback Process explains the Maintenance BMP evaluation process. The identified BMP revisions or new approved BMPs for the Staff Guide by the end of each fiscal year are summarized by the Headquarters Maintenance Stormwater Coordinator at the Maintenance Stormwater Advisory Team (MSWAT) meeting.

## 1.2 Regulatory Background

Federal regulations for controlling discharges of pollutants from municipal separate storm sewer systems (MS4s), construction sites, and industrial activities were incorporated into the National Pollutant Discharge Elimination System (NPDES) permit process by the 1987 amendments to the Federal Water Pollution Control Act (also referred to as the Clean Water Act (CWA) and the federal stormwater regulations issued by the U.S. Environmental Protection Agency (EPA) in 1990.

In California, the EPA delegated the NPDES permitting authority to the State Water Resources Control Board (SWRCB) and the nine Regional Water Quality Control Boards (RWQCBs). Figure 1-1 depicts how the Caltrans district boundaries and RWQCB boundaries overlap.



**Figure 1-1. Map of California with Regional Water Quality Control Boards and Caltrans Districts Boundaries**

Under federal regulations, aspects of Caltrans’ facilities and highway systems are under the jurisdiction of NPDES stormwater regulations for two primary reasons:

1. Highways and related facilities are served by extensive stormwater drainage systems that in urban areas are often connected to, and are considered to be comparable to, MS4, which are covered explicitly in the regulations.

2. Construction of highways and related facilities often results in soil disturbance for which specific requirements are contained in the federal regulations and the State's General Permit for Stormwater Discharges Associated with Construction Activity (Construction General Permit (CGP) or the Lake Tahoe (LTCGP).

### 1.2.1 Caltrans National Pollutant Discharge Elimination System Permit

To achieve a consistent approach to comply with the stormwater regulations, Caltrans determined that a statewide permit would be the most effective means to address its activities in all Districts. To comply with the stormwater regulations, Caltrans implemented a program to reduce the discharge of pollutants to stormwater drainage systems that serve highways and highway-related properties, facilities and activities. This program is described in the 2016 Caltrans' Statewide Stormwater Management Plan (SWMP) and other guidance documents.

On July 15, 1999, the SWRCB issued the first "NPDES Permit, Statewide Stormwater Permit and Waste Discharge Requirements (WDRs) for the State of California, Department of Transportation (Caltrans)" (NPDES No. CAS000003) hereby called "Caltrans NPDES Permit." The Caltrans NPDES Permit requires the preparation and implementation of the SWMP. The SWMP describes how Caltrans plans to implement the Caltrans NPDES Permit requirements and describes Caltrans' program addressing stormwater pollution control related to various activities, including planning, design, construction, maintenance, and operation of roadways and facilities. Order 2012-0011-DWQ was adopted in 2012 and supersedes the 1999 Caltrans NPDES Permit.

The Caltrans NPDES Permit requires Caltrans to implement a year-round program in all parts of the State to effectively control stormwater and non-stormwater discharges. Discharges from Caltrans' rights-of-way that are not composed entirely of stormwater are prohibited. The permit language states that "Discharge of material other than storm water, or discharge that is not composed entirely of storm water, to waters of the United States or another permitted MS4 is prohibited, except as conditionally exempted under Section B.2 of this Order or authorized by a separate NPDES Permit (Permit (amended April 7, 2015), General Discharge Prohibitions, A.3)." To meet this requirement, Caltrans developed a series of BMPs to minimize pollutants in the stormwater to the maximum extent practicable (MEP). A copy of the Caltrans Permit shall be maintained at every maintenance facility and be available to personnel and regulators. It can be downloaded from the SWRCB web site at:

[http://www.swrcb.ca.gov/water\\_issues/programs/stormwater/caltrans.shtml](http://www.swrcb.ca.gov/water_issues/programs/stormwater/caltrans.shtml)

### 1.2.2 Statewide Stormwater Management Plan

The Caltrans NPDES Permit directs Caltrans to implement and maintain an effective SWMP. The SWMP is the Caltrans policy document that describes how Caltrans conducts its stormwater management activities (i.e., procedures and practices), provides descriptions of each of the major management program elements, discusses the processes used to evaluate and select appropriate BMPs and presents key implementation responsibilities and schedules.

The program to implement Maintenance BMPs as part of the ongoing management by the Division of Maintenance for existing highways and highway-related properties, facilities and activities (SWMP Section 8) including:

- Inspection and Surveillance;
- Trash and Litter Removal;
- Maintenance BMP Requirements;
- Vegetation Management;
- Slopes Prone to Erosion and Sediment Discharge;

- Landslide Management Activities;
- Storm Drainage System Maintenance (including inspection and cleaning program);
- Waste Management;
- Maintenance of Treatment BMPs (TBMPs); and
- Management of Pavement Grindings.
- Implementation of BMPs to reduce the potential for storm water pollution at Maintenance facilities by minimizing contact between storm water and various materials and substances used and stored at Maintenance facilities including but not limited to:
  - Preparation and Implementation of Facility Pollution Prevention Plans
  - Implementation of FPPPs and inspections of Facilities

### 1.3 Roles and Responsibilities

The Headquarters Division of Environmental Analysis coordinates implementation of the SWMP through two lines of authority, traditional line management and functional line management. Traditional line management consists of 12 District Directors and the functional Division Chiefs within each District (i.e., Maintenance, Planning, etc.). Functional line management consists of the Director, the Deputy Directors and the Headquarters' Division Chiefs (i.e., Maintenance, Environmental, etc.) and their functional counterparts in the Districts (e.g., functional Division Chiefs). The Maintenance management positions and functional relationships for the Maintenance stormwater program are presented in Figure 1-2.

The Headquarters Division of Maintenance, Office of Stormwater and Environmental Compliance, in consultation and coordination with the Headquarters Division of Environmental Analysis (DEA), is responsible for:

- Managing the Maintenance Stormwater Management Program as presented in the SWMP;
- Developing and maintaining guidance documents, such as the stormwater and environmental guidelines of the Caltrans Maintenance Manual and this Staff Guide;
- Providing general guidance on the implementation of BMPs;
- Monitoring the Maintenance Stormwater Management Program in the Districts to ensure the BMPs are adequately implemented; and
- Evaluating the Districts' implementation of BMPs in managing stormwater discharges associated with the maintenance of the Caltrans facilities, highways, highway-related properties and assisting in the preparation of the Caltrans Annual Report to the SWRCB, as it relates to maintenance activities.

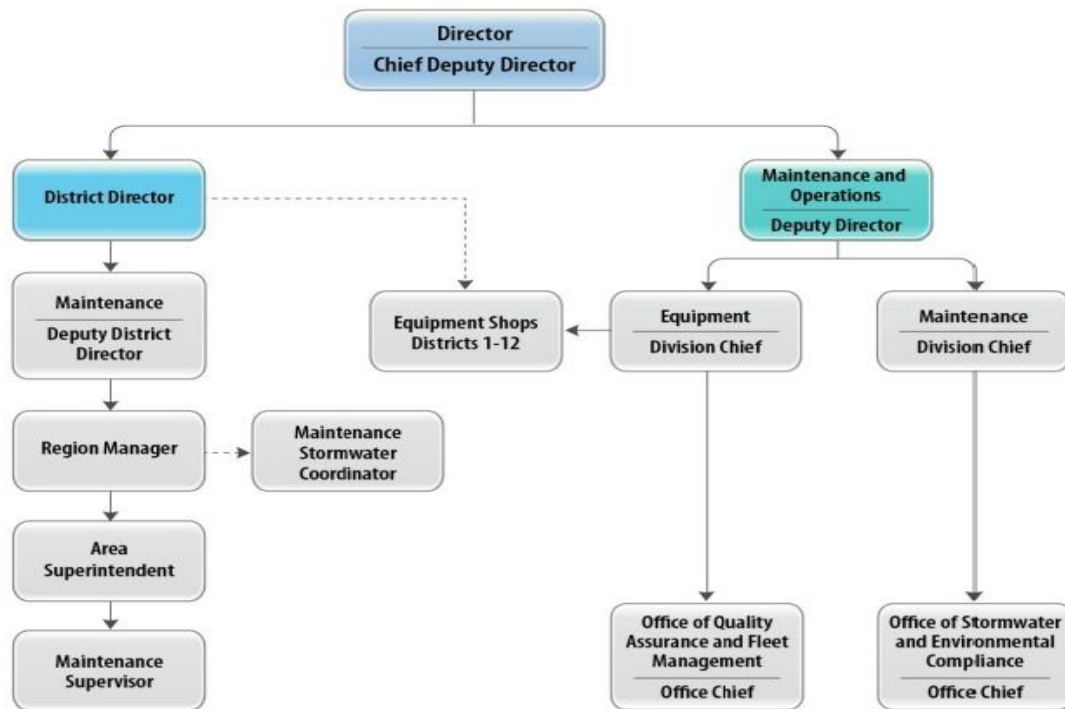

Figure 1-2. Maintenance and Operations Stormwater Management Program Functional Relationships

The Headquarters Maintenance Division Chief is responsible for statewide implementation policies and procedures, the personnel and equipment of the Division of Maintenance. This includes ensuring compliance with all elements of the SWMP required by the Division of Maintenance.

The Headquarters Office of Maintenance Stormwater and Environmental Compliance Chief (OSWEC) is the liaison with Headquarters Division of Environmental Analysis. The Headquarters Maintenance Division provides guidance to District NPDES and District Maintenance Stormwater Coordinators regarding water quality issues. The Chief OSWEC is responsible for overseeing development of stormwater guidance documents used by Maintenance.

The Districts are responsible for implementing the SWMP within each District and complying with the Caltrans NPDES Permit and any RWQCB-specific requirements.

- The Maintenance District Division Directors are responsible for the implementation of the policies, procedures, personnel and equipment of the District Maintenance Stormwater Management Program within their respective Districts. This includes ensuring compliance with all elements of the SWMP required to be implemented by the District Maintenance Divisions.
- The District Maintenance Managers direct maintenance activities within regions or programs of a District. Each region is subdivided into Maintenance Areas. The Maintenance Manager provides direct supervision to the Maintenance Area Superintendents within each region or program.
- The District Maintenance Area Superintendents direct maintenance activities and provide direction to Maintenance Supervisors. Maintenance Areas contain multiple maintenance facilities. The Superintendents are responsible for ensuring that Maintenance BMPs are implemented in their jurisdictions.



- The District Maintenance Area Supervisors are responsible for direct supervision of a maintenance crew. Supervisors provide on-the-job training for specific crew assignments, including compliance with water quality protection requirements. Supervisors have on-site responsibility for BMP implementation.
- The District NPDES Stormwater Coordinators serve as liaison with the Water Quality Program. Liaison activities include conducting meetings related to stormwater management issues with the coordinators from each functional unit and with other MS4 permittees to resolve problems and concerns. Liaison activities also include regular communications with representatives of the RWQCB. The functional unit coordinators will assist the District Divisions in implementing the Division's stormwater management activities.
- The District Maintenance Stormwater Coordinators are established in each District. Districts have designated Stormwater Coordinators, in other functional units such as, Environmental, Construction and Design. District Maintenance Stormwater Coordinator responsibilities include:
  - Serving as the point of contact for regulatory inquiries regarding implementation of the Maintenance Stormwater Management Program;
  - Reviewing proposed stormwater compliance programs for elements related to maintenance activities;
  - Monitoring and evaluating BMPs implementation and effectiveness as related to maintenance activities;
  - Participating in meetings related to stormwater management issues with stormwater coordinators from other functional units in the District to resolve problems, concerns and areas that need attention, including but not limited to the MSWAT;
  - Coordinating with Headquarters Division of Maintenance to arrange training of District Maintenance personnel in stormwater quality management; and
  - Compiling and preparing materials and supporting data for the Maintenance portion of the SWMP Annual Report to the SWRCB in coordination with HQ Maintenance.
- The District Hazardous Material Coordinators (also referred to as District Hazardous Material Managers) coordinate response to spills of hazardous substances on Caltrans rights-of-way and coordinates management of Caltrans-generated hazardous waste. The coordinator is usually responsible for providing training information associated with hazardous materials and may be responsible to assist in implementing stormwater quality protection practices in the District.
- The District Landscape Specialists provide guidance regarding use of pesticides and chemical control of vegetation in field maintenance operations. The Landscape Specialist is responsible for ensuring that all chemicals used in the District are approved for use on Caltrans rights-of-way and approved by the responsible regulatory agencies.
- The Leadworkers conduct tailgate meetings (in absence of the Maintenance Area Supervisor) to review environmental concerns, BMPs and ensure that appropriate procedures are implemented during maintenance activities.
- The Maintenance Workers/Landscape Workers/Equipment Operators are responsible for implementing BMPs while conducting maintenance activities.
- The District Equipment Managers ensure that vehicle inspections include checks for leaks on District Maintenance vehicles.



- The Equipment Shop Superintendents are the front-line managers who direct vehicle servicing and repair activities within an equipment shop or service region.
- The Mechanics (Resident/Traveling) are responsible for implementing BMPs while conducting vehicle servicing and repair activities (Maintenance Manual Vol. 1, Section F.01).

## 1.4 Maintenance Staff Guide Organization

The Staff Guide is organized as follows:

- Section 1 – Introduction. This section identifies the purpose and scope of the Staff Guide, provides the regulatory background to stormwater protection and the roles and responsibilities of the Maintenance staff.
- Section 2 – Objectives. This section provides the objectives of the Maintenance Stormwater Management Program, the pollutants of concern for Maintenance facilities and highway activities, how the BMPs are incorporated into the Maintenance program and the program evaluation.
- Appendix A – Acronyms and Definition of Terms.
- Appendix B – Activity Cut-Sheets. This appendix contains maintenance activities organized as Maintenance Family activities for facility operations and highway activities. The BMPs are summarized for common Family activities that have the potential to affect water quality.
- Appendix C – Maintenance BMPs. This appendix contains the detailed Maintenance BMPs to be used for Maintenance facility operations and highway activities.

THIS PAGE INTENTIONALLY LEFT BLANK

## Section 2

# Objectives of Maintenance Stormwater Management Program

## 2.1 General Objectives of the Program

The Caltrans Maintenance Manual provides direction, guidance, policies and procedures for all the maintenance activities performed by Maintenance personnel. To ensure that maintenance activities are conducted in a manner that prevents or controls the pollutants discharged to surface waters, Caltrans Maintenance Manual Vol. 1 established a Maintenance Stormwater Management Program providing this overall program objective.

A key component to meeting the Maintenance Stormwater Management Program objective is the development of the Staff Guide. The Staff Guide is a Maintenance employee handbook that incorporates the approved Maintenance BMPs presented in the SWMP. Reviewing all the potentially applicable Maintenance BMPs may not be practicable for each maintenance activity and facility operation. By associating the BMPs to the Maintenance activities defined in the Caltrans Maintenance Manual, the Staff Guide focuses on providing detailed instructions on how to apply the BMPs to maintenance activities. The Staff Guide is organized to include the:

- Objectives of the Maintenance stormwater program,
- Pollutants of concern at Maintenance facilities and activities,
- Incorporation of stormwater controls into maintenance operations and activities,
- Stormwater Program evaluation,
- Detailed Activity Cut-Sheets, and
- Maintenance BMPs.

The Caltrans NPDES Permit and the SWMP require the use of BMPs to control potential pollutants that could be discharged to the stormwater drainage systems. Maintenance field personnel perform a key role in this program. They observe and correct situations that could affect water quality. In addition, they conduct highway activities such as road and bridge repair and vegetation management, using BMPs described in this Staff Guide. The other BMPs described herein are intended for use at Maintenance facilities. The BMPs described in this Staff Guide have been selected to focus on those stormwater-related pollutants of concern most likely to come from Maintenance facility operations and highway activities.

The Maintenance Stormwater Management Program has 11 specific targeted objectives for Maintenance management. These objectives are reported periodically as part of program effectiveness and evaluation process. The information from these activities are used to assess compliance with the Caltrans NPDES Permit and SWMP. The targeted objectives are:

- (A) The TBMPs are to be inspected, cleaned, maintained or repaired at least once a year. Inspect prior to and during the rainy season for functionality.

- (B) All drain inlets and catch basins are to be inspected at least annually in urbanized areas and cleaned of waste or debris if they reach 50% capacity (or less if necessary) statewide.
- (C) Areas of Special Biological Significance (ASBS) are ocean or estuarine areas that require special protection of species or biological communities. The discharge of waste, or non-exempt non-stormwater to ASBS are prohibited. The ASBS stormwater outfall drains equal to or greater than 18 inches in diameter or width shall be inspected once prior to the beginning of the rainy season and once during the rainy season and maintained to remove trash and debris.
- (D) Training attendance of maintenance personnel on stormwater BMP implementation is required for new employees and as a refresher course every four years. The goal is to train 25% of the personnel annually.
- (E) The Facility Pollution Prevention Plan shall be revised or updated whenever a Caltrans NPDES Permit violation is found or if there are changes to the facility that could threaten water quality but no later than the three years from the last update.
- (F) All highway slopes statewide shall be inspected within five years to check for erosion. At least 20% of highway shoulder in each Districts should be inspected annually to meet this objective. Identified unstable or eroding surface, and slopes prone to erosion shall be prioritized for repair and stabilization.
- (G) Total Maximum Daily Loads (TMDL) are waste allocations for water bodies impaired with specific pollutants of concern. In TMDL watersheds where Caltrans is an identified waste contributor, Maintenance shall implement BMPs to reduce the sediment, debris or trash load coming from the right-of-way.
- (H) Maintenance facilities including waste or material storage sites, California Highway Patrol vehicle inspection facilities, California Food and Agriculture Border Protection stations, equipment shops and rest areas are evaluated by independent quality assurance auditors for Caltrans NPDES Permit compliance. While maintenance yards and storages are inspected monthly by supervisors, the auditors conduct unannounced reviews of at least 20% of statewide facilities annually.
- (I) Use of chemical vegetation control are reported including the volume, type and location of pesticides applied to control the spread or growth of unwanted vegetation. Refer to Chapter C2 of Maintenance Manual Volume I for more information on use and recordkeeping of pesticides.
- (J) Solid waste collected in Maintenance facilities prior to disposal shall be accounted and reported by volume annually to the Maintenance Stormwater Coordinator as part of waste management inventory. The volume of highway trash and litter collected from drainage systems are reported. Refer to Maintenance Manual Chapter D1 for more information on litter, debris and sediment removal.
- (K) Incidents of emergency, field or administrative non-compliance such as highway spills, discharge of pollutants, or failure to maintain a Facility Pollution Prevention Plan requires filing an Incident Report Form to the District NPDES Stormwater Coordinator who reports the incident through the SWRCB tracking system.

## 2.2 Pollutants of Concern for Highway Maintenance Activities and Facilities

Maintenance activities are organized into several Families (Families A to T) consistent with the Department's methods used to record, report and monitor maintenance work as it is planned and performed. Within each Family, there are numerous specific activities, each of which may contribute pollutants via the stormwater drainage system. Selecting the appropriate BMP(s) requires an understanding of the types of pollutants that the BMP is designed to remove or capture.

"Pollutants of concern" include a broad range of materials that could result in adverse effects if discharged to receiving waters. Caltrans' maintenance activities involve the use of a wide variety of products. Under normal intended conditions of use these materials are generally not considered "pollutants of concern." However, if these products are used, stored, spilled or disposed of in a way that may cause them to contact stormwater, they may become a concern for water quality. The typical pollutants generated by Caltrans' Maintenance facility operations and during highway activities are described below.

### 2.2.1 Petroleum Products

Petroleum products (e.g., gasoline, diesel fuel, motor oil and other lubricants) are common pollutants deposited on the highways and Caltrans' rights-of-way. Some fuels and lubricants contain additives, which may themselves be toxic to humans and aquatic life.

Potential sources of petroleum products from Caltrans' activities include leaks from vehicles and machinery and maintenance activities such as fueling, changing oil and washing. Although petroleum products are commonly used on a daily basis, it is important to be careful about how they are used and disposed.

### 2.2.2 Sediment

In general, sediment is considered a pollutant when it significantly exceeds natural concentrations. Sometimes other potential pollutants (e.g., lead) may become attached to sediments and are transported with the sediments to receiving waters, increasing the potential for water quality impacts.

Possible sources of sediment in runoff from Maintenance facilities and highway maintenance activities include the tracking, transport and storage of loose bulk materials (e.g., sand or other aggregate), grading-related activities, soil erosion from failed slopes or runoff from operations where ground surface is disturbed.

### 2.2.3 Trash/Litter

All improperly discarded waste material associated with human habitation, of human origin; or from any producing, manufacturing, or processing operation including, but not limited to, product packaging or containers constructed of steel, aluminum, glass, paper, plastic, and other natural and synthetic materials that are thrown or deposited in waters or where it could be transported, as floating, suspended, and/or settleable materials, to waters of the State, including watersheds. Litter in stormwater is defined as manufactured objects made from paper, plastic, cardboard, glass, metal, etc. and includes aluminum cans, styrofoam cups and other items commonly discarded which can be transported by wind and stormwater into the storm drainage system (Caltrans NPDES Permit). This definition does not include materials of natural origin such as gravel or vegetation. Trash is quantified by 24-hour air-dried volume and weight measurements.

Trash in surface waters can inhibit the growth of aquatic vegetation, harm aquatic organisms by ingestion or entanglement, convey other pollutants, such as toxic substances and cause aesthetic

problems on shorelines. In addition to impacting water quality, these items may obstruct the stormwater drainage system.

#### 2.2.4 Metals

The term “metals,” as used here, refers to dissolved and suspended metals. Metals found in highway stormwater runoff are considered pollutants because above a certain threshold even low concentrations of these materials may harm aquatic life.

These metals come from various sources and activities, including fuel combustion, brake pad wear (copper, total and dissolved), tire wear (cadmium and zinc), metal corrosion, pressure-treated wood and creosote posts used for guard rails (arsenic), paints, herbicides and other materials.

#### 2.2.5 pH

The pH of a water sample is a measure of the degree of its acidity or alkalinity. Water that is acidic or alkaline potentially causes harm to aquatic organisms or consumers of the water and may result in damage to equipment and materials.

Some Caltrans’ maintenance activities that may change the pH of runoff include the storage of cracked batteries resulting in leaking battery acid, tube and tunnel washing and management of concrete wastes.

#### 2.2.6 Nutrients

A nutrient is any substance assimilated by living things that promote growth. The term is generally applied to nitrogen and phosphorus in wastewater but is also applied to other essential trace elements.

Excessive nutrients, such as phosphorus and nitrogen, that discharge to receiving waters can over-stimulate the growth of aquatic plants causing abnormal algal blooms which contribute to low dissolved oxygen levels and can result in fish kills. Nutrients generally have more adverse effects in water bodies with slow flushing rates, such as slow-moving streams and lakes. Also, nutrients attached to suspended solids in stormwater runoff can impact water quality when they settle out downstream.

Some of the possible sources of nitrogen and phosphorous from Caltrans’ maintenance activities and facilities include storage of fertilizers, decaying plant materials from tree trimming, vegetation management surfactants and emulsifiers and natural sources such as the mineralized organic matter in soils.

#### 2.2.7 Pathogens

Pathogenic microorganisms, including viruses, bacteria, protozoa and helminth worms, are of concern in stormwater runoff. The direct measurement of specific pathogens in water is extremely difficult. For that reason, the coliform group of organisms is commonly used as an indicator of the potential presence of pathogens of fecal origin. Sources of total and fecal coliforms in stormwater runoff are ubiquitous (e.g., soil microorganisms, wild and domestic animal droppings). Human sources could include illicit sewer connections, seepage from septic tanks homeless encampments, and illegal dumping into stormwater systems by recreational vehicles and garbage trucks.

#### 2.2.8 Pesticides

A pesticide is a chemical agent designed to control pest organisms. The most common forms of pesticides are organic chemicals designed to target insects (insecticides) or vascular plants (herbicides). Pesticides have been repeatedly detected in surface waters and precipitation in the United States. Water is one of the primary media in which pesticides are transported from targeted applications to other parts of the environment. As the use of pesticides has increased, concerns about the potential adverse effects

of pesticides on the environment and human health have also increased. Pesticides and herbicides are used in Caltrans' chemical weed control and integrated pest management activities.

### 2.2.9 Other Pollutants

Other pollutants originating from Caltrans' maintenance facilities and activities include asphalt, detergents, epoxy resins, deicers (melts icing on the road surface) and anti-icers (prevents icing on the road surface).

A common product used extensively in Caltrans' maintenance activities is asphalt (especially cold mix), which, while not a pollutant under normal conditions of use, could potentially contribute pollutants to surface waters if mishandled or disposed of improperly.

Synthetic detergents and their additives also contain a variety of chemicals that are potentially harmful in the environment. Some of these additives, such as bleaches, dyes, fragrances and enzymes, are toxic to aquatic life. Detergents are commonly used in cleaning and washing activities as part of routine maintenance of vehicles and equipment.

Some bonding products, adhesive materials and protective coatings contain epoxy resins. Caltrans' maintenance activities that use epoxy resins include repairs of cracks, joints, bridges, barriers and irrigation lines. Constituents of epoxy products may be toxic to aquatic life or potentially carcinogenic (cancer-causing) to humans.

## 2.3 Incorporation of Best Management Practices into Maintenance Programs and Activities

As described above, the potential pollutants of concern for Caltrans' Maintenance operations and activities include petroleum products, sediment, litter and debris, metals, pH, nutrients, pathogens, pesticides and other pollutants. Many of these potential pollutants can be prevented from being discharged via the stormwater drainage system. This can be achieved by selecting and implementing appropriate BMPs.

Caltrans established BMP categories in the SWMP. The categories include:

1. Maintenance BMPs. These are BMPs implemented when conducting Maintenance facility operations and highway activities that may affect stormwater quality.
2. Design Pollution Prevention (DPP) BMPs. These permanent measures to reduce pollution discharges (e.g., reduce erosion, manage non-stormwater discharges, etc.) after construction is completed. DPPs are used as a strategy to minimize runoff, maximize infiltration, and reduce erosion.
3. Construction Site BMPs (CSBMP), These are BMPs applied during construction activities to reduce pollutants in stormwater discharges. They provide both temporary control of erosion, sediment and other pollutants.
4. Treatment BMPs (TBMPs). Those BMPs that have been scientifically proven to reduce pollutant discharges. Caltrans has a variety of approved TBMPs; however, additional devices can be considered after following a BMP evaluation and approval process

Caltrans developed a wide range of Maintenance BMPs that are suitable for implementation by Maintenance personnel throughout the State. These BMPs are provided in Appendix C of the Staff Guide for easy referencing.

## 2.4 Feedback Process

Evaluation and implementation of BMPs by field personnel is key to the process of continually improving the Maintenance Stormwater Management Program. As part of the implementation of the SWMP, Caltrans regularly reviews its activities, inspects its facilities, oversees and guides its personnel and conducts focused studies to refine, enhance and improve BMPs. Information obtained will support responsible management of the limited resources available to implement the BMPs and control pollutants from entering stormwater drainage systems to the MEP. This monitoring and evaluation program serves as a quality control mechanism to help assess the effectiveness of the implementation of activities as required by the SWMP. The program evaluation will be an iterative process - a continuous loop of gathering information about implementation, evaluating and learning from the information that is collected and providing feedback that will result in continuous improvement. Field personnel are encouraged to complete the BMP Questionnaire (Figure 2-2).

Field personnel can submit the questionnaire to their Maintenance Supervisor, who can send their BMP concerns directly to the District Maintenance Stormwater Coordinator and carbon copy (cc) the Superintendent and Region Manager. The Statewide Maintenance Stormwater Coordinator will review the questionnaires, discuss with the MSWAT and identify BMPs requiring modification (Figure 2-3). Identified BMP revisions in the Maintenance Staff Guide by the end of each fiscal year are summarized by the Headquarters Maintenance Stormwater Coordinator at the MSWAT meeting.



### Maintenance Activity Questionnaire

**Activity:**

**Date:** \_\_\_\_\_ **County:** \_\_\_\_\_

**District:** \_\_\_\_\_ **Route:** \_\_\_\_\_

**Name:** \_\_\_\_\_ **Post Mile:** \_\_\_\_\_

**Title:** \_\_\_\_\_ **Maintenance Facility:** \_\_\_\_\_

Can any of the BMP procedures being implemented be improved? Please describe new or improved BMP procedures. (Attach additional comments as necessary.)

If the BMP is not being implemented as described in the Maintenance Staff Guide, what is the cause:

Safety Concern Describe: \_\_\_\_\_

Lack of Training

Operational Describe: \_\_\_\_\_

Equipment or material availability Describe equipment or material needs: \_\_\_\_\_

Personnel (Additional personnel are needed.) Describe additional person-years (PYs) required: \_\_\_\_\_

Financial Resources Describe the category of financial resources: \_\_\_\_\_

**Reviewed by:**

Supervisor  Superintendent  Region Manager  Stormwater Coordinator

Figure 2-2. Best Management Practices Questionnaire

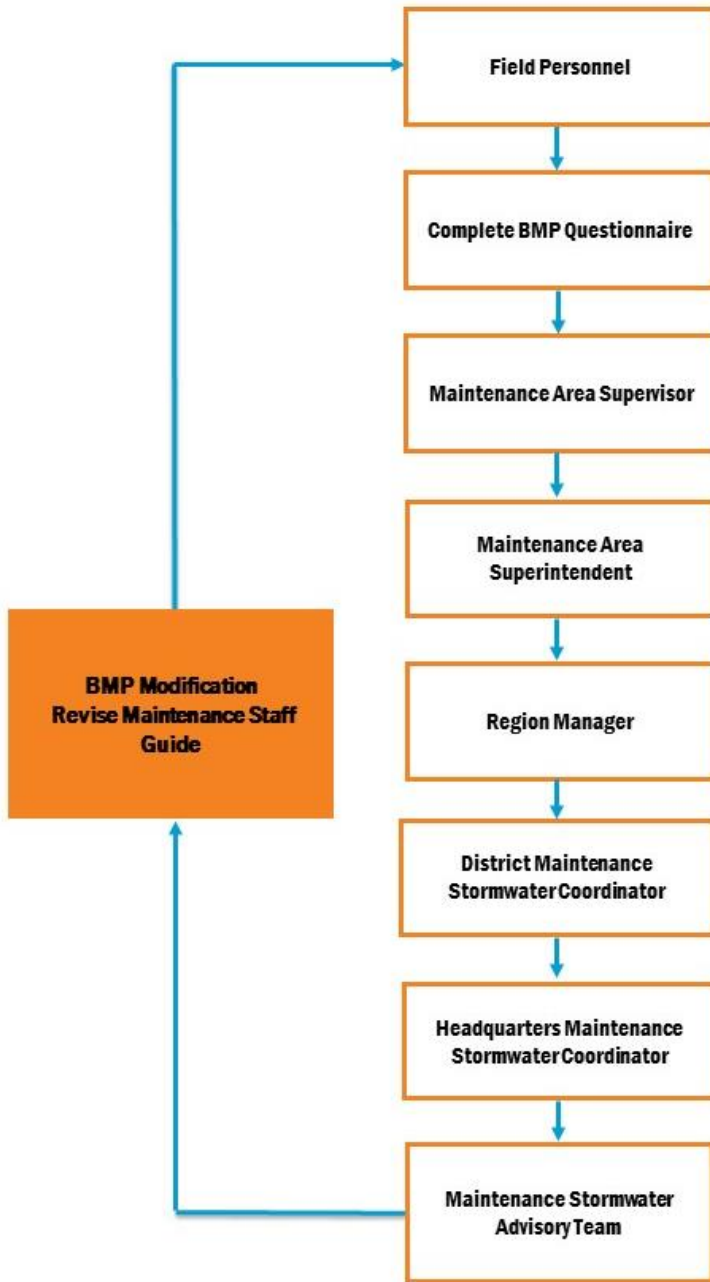

Figure 2-3. Feedback Process

## Appendix A: Acronyms and Definition of Terms

---

This page intentionally left blank

## Acronyms

ASBS	Areas of Special Biological Significance
BMP	Best Management Practice
Caltrans	California Department of Transportation
CCR	California Code of Regulations
CWA	Clean Water Act
CSR	Customer Service Request
DII	Drain Inlet Insert
DTSC	Department of Toxic Substance Control
EPA	U.S. Environmental Protection Agency
ESA	Environmentally Sensitive Area
IC/ID	Illegal Connections/Illicit Discharges
IC/IDDE	Illegal Connections/Illicit Discharge Detection, Reporting and Elimination
IMMS	Integrated Maintenance Management System
MCTT	Multi-Chambered Treatment Train
MEP	Maximum Extent Practicable
MOU	Memorandum of Understanding
MS4	Municipal Separate Storm Sewer System
NOAA	National Oceanic and Atmospheric Administration
NPDES	National Pollutant Discharge Elimination System
PCA	Pest Control Advisor
PCC	Portland Cement Concrete
POTW	Publicly owned treatment works
RWQCB	California Regional Water Quality Control Board
SDS	Safety Data Sheet
SHOPP	State Highway Operation and Protection Program
SPCC	Spill Prevention Control and Countermeasure
SWMP	Stormwater Management Plan
SWRCB	California State Water Resources Control Board
TBMPs	Treatment BMPs
U.S.	United States
USA	Underground Service Alert
WDR	Waste Discharge Requirements

## Definition of Terms

**Areas Prone to Erosion:** Segments of highway requiring erosion control and stabilization activities for the past three consecutive years (Caltrans Stormwater Management Annual Report [October 2016]).

**Areas of Special Biological Significance (ASBS):** Ocean or estuarine areas designated by the State Water Board that require special protection of species or biological communities to the extent where alteration of natural water quality is undesirable. The California Ocean Plan describes ASBSs as “those areas containing biological communities of such extraordinary value that no risk of change in their environment as the result of man’s activities can be entertained”. ASBSs are a subset of the State Water Quality Protection Areas.

**Best Management Practice (BMP):** Schedule of activities, prohibitions of practices, maintenance procedures, and other management practices to prevent or reduce the pollution of “waters of the United States.” BMPs include structural and nonstructural controls, treatment requirements, operation and maintenance procedures, and practices to control plant site runoff, spillage or leaks, sludge or waste disposal, or drainage from raw material storage.

**Caltrans NPDES Permit:** Refers to the National Pollutant Discharge Elimination System Statewide Stormwater Permit and Waste Discharge Requirements Waste Discharge Requirements for the State of California, Department of Transportation (Caltrans), NPDES No. CAS000003(Order No. 2012-0011-DWQ), adopted by the SWRCB on September 19, 2012 as amended by Order WQ 2014-0006-Exec, Order WQ 2014-0077-DWQ and Order WQ 2015-0036-Exec(or the most recent permit issued).

**Clean Water Act Section 303(d):** Section 303(d) of the Clean Water Act requires States to identify waters (“impaired” water bodies) that do not meet water quality standards after applying certain required technology-based effluent limits. States are required to compile this information in a list and submit the list to the U.S. EPA for review and approval. This list is known as the Section 303(d) list of impaired waters (Caltrans NPDES Permit).

**Drainage inlet:** A location where water runoff enters a stormwater drainage system that includes streets, gutters, conduits, natural or artificial drains, channels and watercourses, or other facilities that are owned, operated, maintained and used for the purpose of collecting, storing, transporting or disposing of stormwater.

**Environmentally Sensitive Areas:** Environmentally Sensitive Areas (ESAs) are area within or near Caltrans rights-of-way where access is prohibited or limited to protect environmental resources.

**Erosion:** The diminishing or wearing away of land due to wind, or water. Often the eroded material (silt or sediment) becomes a pollutant via stormwater runoff. Erosion occurs naturally, but it can be intensified by land disturbing and grading activities such as farming, development, road building, and timber harvesting.

**Existing vegetation:** Any vegetated area that has not already been cleared and grubbed.

**Fire protection strips:** Buffer strips adjacent to the right-of-way where vegetation is controlled to reduce the risk of fire.

**Good housekeeping:** Practices and procedures to eliminate the potential for discharge of pollutants to drainage paths, storm water drainage systems or watercourses by promoting efficient and safe storage, use and cleanup of potentially harmful materials.

**Grubbed:** Vegetation has been removed by mechanical or manual methods.

**Hazardous waste:** As defined in Article 25141 of the Health and Safety Code (H & S). Hazardous waste is a waste which because of its quantity, concentration, physical, chemical, or infectious character may either cause or significantly contribute to an increase in mortality or an increase in serious irreversible or incapacitating illness. Hazardous waste can pose a substantial present or potential hazard to human health or environment due to factors including, but not limited to: carcinogenicity, acute toxicity, chronic toxicity, bio-accumulative properties, or persistence in the environment, when improperly treated, stored, transported, disposed of/otherwise managed (Caltrans Hazardous Waste Manual (June 2009)).

**Herbicide:** A pesticide designed to control or kill plants, weeds, or grasses.

**Hydrologic unit:** A subunit of a basin as defined by a RWQCB.

**Illegal Connection:** An engineered conveyance that is connected to an MS4 without authorization by local, state, or federal statutes, ordinances, codes, or regulations.

**Illicit Discharge:** Any discharge to an MS4 that is prohibited under local, state, or federal statutes, ordinances, codes, or regulations. It includes all non-stormwater discharges except conditionally exempt non-stormwater discharges.

**Illegal Dumping:** Discarding or disposal within the Caltrans right-of-way, properties or facilities, either intentionally or unintentionally, of trash or other wastes in non-designated areas that may contribute to stormwater pollution.

**Integrated Maintenance Management System (IMMS):** The Integrated Maintenance Management System (IMMS) is a management system that allows the Maintenance Division to effectively plan, perform, and manage maintenance work (Maintenance Manual Vol. 1, Chap. 10.01).

**Litter:** Litter in stormwater is defined as manufactured objects made from paper, plastic, cardboard, glass, metal, etc. and includes aluminum cans, styrofoam cups and other items commonly discarded which can be transported by wind and stormwater into the storm drainage system (Caltrans NPDES Permit).

**Maintenance activities:** Activities (aka: routine maintenance activities) intended to maintain the original line and grade, hydraulic capacity, or original purpose of a facility. Routine maintenance does not include replacement of existing roadway surfaces where the underlying soil or pervious subgrade is exposed.

**Maintenance facilities:** Facilities under Caltrans' ownership or control "...including vehicle maintenance facilities, salt and sand storage facilities, material and equipment storage facilities, roadside rest areas, agricultural and highway patrol weigh stations, sweeper and roadway waste and vector decant storage or disposal locations..."(USEPA Region 9 – Finding of Violation and Order for Compliance Docket No. CWA-09-2011-0001, II.B.18).

**Maintenance Staff Guide:** An employee handbook for Caltrans Maintenance personnel designed to provide detailed instructions on applying the approved Maintenance stormwater Best Management Practices (BMPs) to Maintenance facility operations and highway activities (see Section 1.1).

**Maintenance Stormwater Management Program:** The Maintenance Stormwater Management Program is the component of the SWMP that:

- Defines and implements Maintenance Best Management Practices (BMPs) to ensure all Division of Maintenance facilities are in compliance with NPDES requirements
- Defines and implements BMPs to ensure all Maintenance personnel activities on State highways and within the Department's right of way are in compliance with NPDES requirements
- Manages potential stormwater pollution from accidental spills, illicit connections, illegal discharges, and illegal dumping within the Department's right of way
- Maintains stormwater treatment BMPs

- Conducts periodic erosion inspection and scheduled repairs of State highway vegetated slopes (Maintenance Manual Vol. 1, Chap. F, Section F.00).

**Maximum Extent Practicable (MEP):** The minimum required performance standard for implementation of municipal storm water management programs to reduce pollutants in storm water. Clean Water Act § 402(p)(3)(B)(iii) requires that municipal permits "shall require controls to reduce the discharge of pollutants to the maximum extent practicable, including management practices, control techniques and system, design and engineering methods, and such other provisions as the Administrator or the State determines appropriate for the control of such pollutants." MEP is the cumulative effect of implementing, evaluating, and making corresponding changes to a variety of technically appropriate and economically feasible BMPs, ensuring that the most appropriate controls are implemented in the most effective manner. To achieve the MEP standard, municipalities must employ whatever BMPs are technically feasible and are not cost-prohibitive. Reducing pollutants to the MEP means choosing effective BMPs, and rejecting applicable BMPs only where other effective BMPs will serve the same purpose, or the BMPs would not be technically feasible, or the costs would be prohibitive. A final determination of whether a municipality has reduced pollutants to the MEP can only be made by the State or Regional Water Boards.

**Median area:** The portion of a divided highway separating the traveled ways for traffic in opposite directions. Often contains storm drain system facilities, such as ditches and swales.

**Monitoring:** Refers to a variety of activities and processes through which Caltrans will obtain information relevant to its implementation of the stormwater quality management program and so that the need for and/or opportunities for revising or refining its program can be identified.

**National Pollutant Discharge Elimination System (NPDES):** The national program for issuing, modifying, revoking and reissuing, terminating, monitoring and enforcing permits under the Clean Water Act. In California, the NPDES permits are incorporated into Waste Discharge Requirements.

**Nonpoint source discharge:** Pollution that is not released through a discrete conveyance but rather originates from multiple sources over a relatively large area. Nonpoint sources can be divided into source activities related to either land or water use, including failing septic tanks, animal agriculture, forest practices, and urban and rural runoff.

**Non-stormwater discharge:** Discharges that are not induced by precipitation events and are not composed entirely of storm water. These discharges include, but are not limited to, discharges of process water, air conditioner condensate, non-contact cooling water, vehicle wash water, concrete washout water, paint wash water, irrigation water, pipe testing water, lawn watering overspray, hydrant flushing, and firefighting activities.

**Outfall:** The point source where a municipal storm sewer discharges to waters of the United States.

**Pump station:** A pumping station is a facility and equipment used to move fluids from one place to another. A complete pumping installation includes a storage box, pump or pumps, standby pumps, connecting pipes, electrical equipment, pump house and outlet chamber.

**Regional Water Quality Control Boards (RWQCBs):** In California, U.S. EPA has delegated administration of the federal NPDES program to the State Water Resources Control Board and the nine RWQCBs or Regional Water Boards.

**Reporting:** Refers primarily to information Caltrans will report to the SWRCB, although there also will be instances where information will be reported or otherwise communicated within Caltrans.

**Safety Data Sheet:** A Safety Data Sheet (SDS) is used by chemical manufacturers and importers to convey both the physical hazards (e.g., pH, flashpoint, flammability, etc.) and also the health hazards (e.g., carcinogenicity, teratogenicity, etc.) of their chemicals to the end user.



**Sanitary sewer:** Underground pipes that carry off only domestic or industrial waste, not stormwater.

**Sediment:** Soil, sand, and minerals washed from land into water, usually after rain.

**Site:** The land or water area where any facility or activity is physically located or conducted, including adjacent land used in connection with the facility or activity.

**Soil Stabilization:** Control measures used to minimize erosion.

**Spill:** The sudden release of a potential pollutant to the environment.

**State Water Resources Control Board (SWRCB):** In California, U.S. EPA has delegated administration of the federal NPDES program to the SWRCB and the nine RWQCBs or Regional Water Boards.

**Stormwater drainage system:** Streets, gutters, inlets, conduits, natural or artificial drains, channels and watercourses, or other facilities that are owned, operated, maintained and used for the purpose of collecting, storing, transporting or disposing of stormwater.

**Stormwater Management Plan (SWMP):** Description of the procedures and practices used to reduce or eliminate the discharge of pollutants to storm drain systems and receiving waters.

**Stormwater management practice:** Activities, prohibitions or modifications of practices, maintenance procedures, and other physical, structural and/or managerial practices to prevent or reduce the pollution of waters of the State.

**Stormwater:** Storm water runoff, snowmelt runoff, and surface runoff and drainage, as defined in 40 CFR 122.26 (b)(13).

**Sump:** In drainage, any low area which does not permit the escape of water by gravity flow or rapid ground infiltration.

**Surface runoff:** Precipitation, snow-melt or irrigation water in excess of what can infiltrate the soil surface and be stored in small surface depressions.

**Total Maximum Daily Load (TMDL):** The sum of the individual Waste Load Allocations (WLAs) for point sources and Load Allocations (LAs) for nonpoint sources and natural background. If a receiving water has only one point source discharger, the TMDL is the sum of that point source WLA plus the LAs for any nonpoint sources of pollution and natural background sources, tributaries, or adjacent segments. TMDLs can be expressed in terms of either mass per time, toxicity, or other appropriate measure. If Best Management Practices (BMPs) or other nonpoint source pollution controls make more stringent load allocations practicable, then waste load allocations can be made less stringent. Thus, the TMDL process provides for nonpoint source control tradeoffs (40 CFR 130.2(i)).

**Trash:** All improperly discarded waste material associated with human habitation, of human origin; or from any producing, manufacturing, or processing operation including, but not limited to, product packaging or containers constructed of steel, aluminum, glass, paper, plastic, and other natural and synthetic materials that are thrown or deposited in waters or where it could be transported, as floating, suspended, and/or settleable materials, to waters of the State, including watersheds (Caltrans NPDES Permit).

**Vegetation control:** Maintenance of vegetation on facilities owned by Caltrans by a combination of chemical application (herbicides) and mechanical methods (mowing, cutting, etc.).

**Vista point:** A paved area beyond the shoulder which permits travelers to safely exit the highway to stop and view a scenic area. In addition to parking areas, trash receptacles, interpretive displays, restrooms, drinking water and telephones may also be provided.

**Watercourse:** Surface water bodies including streams, lakes, bays, estuaries, lagoons, reservoirs and ponds.

**Waste oil:** is any oil that has been refined from crude oil and has been used and/or contaminated (Caltrans Hazardous Waste Manual [June 2009]).

# Appendix B - Activity Cut-Sheets

General Best Management Practices .....	3
A Family – Flexible Pavement .....	11
Asphalt Cement Crack and Joint Grinding/Sealing .....	11
Asphalt Paving .....	14
Structural Pavement Failure (Digouts) Pavement Grinding and Paving .....	16
Emergency Pothole Repairs .....	18
Sealing Operations .....	19
B Family – Rigid Pavement.....	21
Portland Cement Crack and Joint Sealing .....	21
Mudjacking and Drilling .....	23
Concrete Slab and Spall Repair.....	25
C Family – Slope/Drains/Vegetation .....	27
Shoulder Grading.....	27
Non-Landscaped Chemical Vegetation Control .....	30
Non-Landscaped Mechanical Vegetation Control/Mowing .....	32
Non-Landscaped Tree and Shrub Pruning, Brush Chipping, Tree and Shrub Removal.....	34
Fence Repair.....	36
Drainage Ditch and Channel Maintenance.....	38
Drain and Culvert Maintenance.....	41
Curb and Sidewalk Repair.....	44
D Family – Litter/Debris/Graffiti .....	46
Sweeping Operations .....	46
Emergency Response and Cleanup Practices .....	50
Graffiti Removal.....	52
E Family – Landscaping.....	54
Chemical Vegetation Control .....	54
Landscaped Mechanical Vegetation Control/Mowing .....	58
Landscaped Tree and Shrub Pruning, Brush Chipping, Tree and Shrub Removal.....	60
Irrigation Lines.....	62
Irrigation (Watering), Potable and Non-potable.....	64
F Family – Stormwater.....	66
Storm Drain Stenciling .....	66
Roadside Slope Inspection .....	68
Roadside Stabilization.....	69
Stormwater Treatment Devices.....	72
G Family – Service Facilities.....	74
Public Facilities.....	74

Stormwater Treatment Devices .....	75
H Family – Bridges.....	76
Welding and Grinding .....	76
Sandblasting, Wet Blast with Sand Injection and Hydroblasting.....	78
Painting .....	80
Bridge Repairs.....	82
Draw Bridge Maintenance .....	84
J Family – Other Structures.....	86
Pump Station Cleaning.....	86
Tube and Tunnel Maintenance and Repair.....	88
Ferryboat Operations .....	90
Tow Truck Operations .....	92
Toll Booth Lane Scrubbing Operations .....	94
K Family – Electrical.....	96
Sawcutting for Loop Installation .....	96
M Family – Traffic Guidance .....	98
Thermoplastic Striping and Marking.....	98
Paint Striping and Marking.....	100
Raised/Recessed Pavement Marker Application and Removal .....	102
Sign Repair and Maintenance.....	104
Median Barrier and Guard Rail Repair .....	106
Emergency Vehicle Energy Attenuator Repair.....	108
R Family – Snow/Ice Control .....	110
Snow Removal.....	110
S Family – Storm/Major Damage.....	114
Minor Slides and Slipouts Cleanup/Repair .....	114
T Family – Support.....	117
Building and Grounds Maintenance .....	117
Storage of Hazardous Materials (Working Stock).....	120
Material Storage Control (Hazardous Waste).....	123
Outdoor Storage of Raw Materials.....	125
Vehicle and Equipment Fueling .....	127
Vehicle and Equipment Cleaning.....	129
Vehicle and Equipment Maintenance and Repair .....	131
Aboveground and Underground Tank Leak and Spill Control .....	134

# General Best Management Practices

In addition to Activity Cut-Sheets, General BMPs were assembled. There are Best Management Practices (BMPs) that are commonly applied to all Maintenance activities. For the purpose of this Staff Guide, these have been termed General BMPs. To minimize the redundant presentation of these more common BMPs in the Activity Cut-Sheets, the General BMPs are considered in all the maintenance activities and should be reviewed with the Activity Cut-Sheets if applicable. The General BMPs include Scheduling and Planning; Spill Prevention and Control; Sanitary/Septic Waste Management; Material Use; Safer Alternative Products; Vehicle/Equipment Cleaning, Fueling, and Maintenance; Illegal Connection/Illicit Discharge; Illegal Spill Discharge Control and Maintenance Facility Housekeeping Practices. Summaries of these General BMPs are provided below with the detailed Maintenance BMPs found in Appendix C. The General BMPs should be reviewed with the Activity Cut-Sheet(s) prior to beginning the scheduled Maintenance activity.

## GENERAL BMPs

### Scheduling and Planning

## IMPLEMENTATION

- Plan and schedule all Maintenance activities in a manner that Planning considers the use of BMPs. Recognize how the activity will affect stormwater so that the proper BMPs can be placed or utilized at the proper time. Some Maintenance activities shall not be performed during rain events or when storms are predicted unless required by emergency conditions. The Activity Cut-Sheets will advise of these conditions. Poor planning does not constitute an emergency condition.
- Reduce the potential for erosion and pollutant transport through wind, rain, runoff and vehicle track-out by not scheduling maintenance activities that could adversely impact stormwater during the rainy season and prior to forecast storm events.
- Plan your work to protect stormwater drainage systems and watercourses from discharge of potential pollutants. Plan ahead when working near stormwater drainage systems and sensitive water bodies. They may need a higher level of awareness and protection.
- Be aware of where the flow of a leak, spill, or other runoff would go.
- Identify drain inlets and watercourses, both upstream and downstream of the work site.
- All vehicles and equipment should be clean and in good operating condition. Perform a thorough pre-operational inspection of vehicles and equipment.

**GENERAL BMPs****IMPLEMENTATION****Spill Prevention and Control**

Practice spill prevention and control at the work site:

- Set-up the work area to minimize the tracking of material by vehicles and equipment in or out of the work area.
- Keep spill cleanup materials available at all sites.
- Any spills should be controlled as soon as it is safe to do so.
- Transport collected materials back to a Maintenance facility or approved storage or disposal site.
- Use drip pans and/or absorbent materials to contain leaks or spills of vehicle fluids.
- If a leak or spill occurs, protect drainage systems and watercourses from spilled material by covering and blocking drain inlets. Remove covers and blocks once cleanup is completed.
- Use dry cleanup methods for stormwater pollutants whenever possible. If water must be used for spill cleanup and/or decontamination, contain the water used for spill cleanup and decontamination and do not discharge to the stormwater drainage system or watercourses.
- Large spills must be contained and cleaned up by trained personnel. Contact your Hazmat Specialist if needed.
- To the extent cleanup activities and safety is not compromised, stormwater pollutant spills shall be covered and protected from stormwater run-on.

**Sanitary/Septic Waste Management**

Portable toilet units are used at locations where permanent bathrooms are unavailable.

- To prevent leakage, inspect and repair portable toilet units before leaving the Maintenance facility.
- Locate portable toilet units at least 50 feet away from stormwater drainage system and watercourses.
- Prevent spills by securing the units to prevent tipping on windy days when necessary.
- Septic waste can only be discharged to a municipal- or state- approved sewage disposal system.
- Inspect hose and connections to prevent spills prior to flushing holding tank at sanitary station.

## GENERAL BMPs

### Material Use

## IMPLEMENTATION

- Control the water used to flush the holding tank to prevent non-stormwater discharges. Use of a positive shutoff valve is advisable. After flushing the holding tank, if it is necessary to rinse or clean the walls, floor and outside of the unit, clean at a designated rinsing area or wash rack to prevent non-stormwater discharges.

Prevent materials used by Maintenance from entering the stormwater drainage systems, watercourses or water bodies. Materials must be delivered, stored, prepared, transported and used in a manner that minimizes or eliminates the discharge of materials to the stormwater drainage systems, watercourses or water bodies.

- Keep a supply of spill cleanup materials and tools near the material use area and clean up all spills as soon as it is safe to do so.
- Use materials only where and when needed to complete the maintenance activity.
- Train employees on proper loading and unloading techniques to prevent spills.
- Avoid depositing materials on the roadway by securing loads, using proper containers and covering loose materials when transporting in open bed trucks.
- When transporting liquids, inspect the condition of containers or tanks to ensure leakage does not occur. Make sure lids or covers are in place and secure.
- When transporting loose materials, inspect truck beds, sideboards, tailgates, cab protectors and pintle hooks both before transporting, and after completing the material delivery.
- Return unused materials to the Maintenance facility for reuse, recycling or proper disposal.

### Safer Alternative Products

- A variety of products may be harmful to the environment. In some Products cases, a less harmful product, commonly referred to as a safer alternative product, can be used for the same purpose. Safer alternative products should be considered for all maintenance activities.
- **The Districts must approve safer alternative products.**
- Use safer alternative products when possible. These may include cleaning and painting products, herbicides, graffiti removers, automotive products and fertilizers.

**GENERAL BMPs****IMPLEMENTATION****Vehicle/Equipment Cleaning, Fueling and Maintenance**

- While safer alternative products may be less harmful to the environment, they are not harmless. Use the materials according to the manufacturer's instructions and keep the materials out of the stormwater drainage system and watercourses.
- Vehicle and equipment washing is allowed only at designated rinsing areas, wash racks or other designated areas. All engine compartment and undercarriage rinsing/washing must be performed within a wash rack facility. The District Maintenance Stormwater Coordinator will approve or provide input on the proper location for a designated rinsing area.
- Maintain vehicles and equipment in a covered maintenance area where possible. Inspect vehicles and equipment daily for leaks and repair as soon as possible. Use drip pans or absorbent pads to contain leaks until repairs are complete.
- Fueling in the field shall not be performed near unprotected drain inlets or watercourses.
- Keep a supply of spill cleanup material near the fueling area and the maintenance area. Cleanup spills as soon as it is safe to do so and dispose of properly. Hosing down of leaks, drips or spills is prohibited. Cleanup is not complete until all absorbent materials are removed from the pavement.
- See T Family Cut-Sheets for vehicle and equipment cleaning, vehicle and equipment fueling and vehicle and equipment maintenance for further details.

**Illegal Connection/Illicit Discharge**

An Illegal Connection is an engineered conveyance that is connected to an MS4 without authorization by local, state, or federal statutes, ordinances, codes or regulations. An Illicit Discharge is any discharge to an MS4 that is prohibited under local, state, or federal statutes, ordinances, codes, or regulations (IC/ID and Illegal Dumping Response Plan [December 2013]).

- Maintenance personnel, as part of their routine inspections and maintenance work, shall report all observed suspected illicit connections to the District Maintenance Stormwater Coordinator, who will forward these observations to the District NPDES Stormwater Coordinator. A Stormwater Pollution/Drainage Problem report form has been developed for use in this activity.



## GENERAL BMPs

## IMPLEMENTATION

### Illegal Spill Discharge Control

This BMP is directed at incidents involving dumping, discharges or spills that affect stormwater.

- All public initiated calls should be directed to the District's Public Affairs Officer. Calls regarding illicit connections should be logged and routed to the District NPDES Coordinator.
- Maintenance Supervisors shall report any reports from field personnel observing illegal dumping or spilling of materials as part of their routine inspections and maintenance work to the District Maintenance Stormwater Coordinator. The District Maintenance Stormwater Coordinator will forward these observations to the District NPDES Stormwater Coordinator. A Stormwater Pollution/Drainage problem report form has been developed for use in this activity.
- If suspected hazardous materials or hazardous waste dumping has occurred, Maintenance Supervisors shall also report the incident to the District Maintenance Hazardous Materials Manager.
- Spill cleanup shall be handled in accordance with the legal authority presented in SWMP Section 2.4.

### Maintenance Facility Housekeeping Practices

Good housekeeping practices are intended to eliminate the potential of discharge of pollutants to drainage paths, stormwater drainage systems and watercourses by promoting efficient and safe storage, use and cleanup of potentially harmful materials. Good housekeeping should be practiced both at the Maintenance facility and at the work site.

- Maintain clean and orderly material and equipment storage areas.
- Use the "first in, first out" policy for material storage and control. Avoid ordering more materials that can be stored properly or used in a reasonable timeframe.
- Properly reuse, recycle or dispose of properly cleaned empty containers, excess materials and equipment or parts.
- Cover materials that have the potential to discharge pollutants to the stormwater drainage system before predicted rains.
- Containers of liquids should be secured with lids until needed.

**GENERAL BMPs****IMPLEMENTATION**

- Inspect the storage areas regularly and maintain a clean work area.
- Clean up spills promptly.
- Use drip pans or absorbent pads under leaking vehicle and equipment to capture fluids.
- Wash water shall not be discharged to the stormwater drainage system or watercourses.
- Collect and transport litter, debris and waste materials from job sites to the Maintenance facility for proper disposal. Manage waste appropriately.

## How to Use Activity Cut-Sheets and Best Management Practices

The following procedures provides information on how to use the Activity Cut-Sheets and General BMPs.

### Activity Cut-Sheets

Typically, several BMPs are potentially applicable to a maintenance activity. Prior to implementing a maintenance activity, the Supervisor and work crew should review each BMP identified for the activity. However, review of each BMP as presented in Appendix C may not be practicable for every maintenance activity. To simplify the review process, BMPs were summarized in the Activity Cut-Sheets for common maintenance activities. The objective of the Activity Cut-Sheet is to provide a straightforward working-level approach to implement pollution control measures. The Activity Cut-Sheets are presented in this appendix.

The Activity Cut-Sheets presented in the Staff Guide consist of common highway activities implemented by Maintenance with a potential to affect water quality. They do not represent a comprehensive inventory of activities encountered by Maintenance. For the maintenance activities that are not represented by an Activity Cut-Sheet, the BMPs provided in Appendix C should be selected for an activity and reviewed for application.

### Activity Cut-Sheet and General Best Management Practices Selection Process

This section describes the process for selecting the Activity Cut-Sheet. Figure B-1 illustrates the selection of the Activity Cut-Sheets for review with General BMPs and the review of the Maintenance BMPs, if additional information is needed.

For example, a work crew is scheduled to conduct asphalt paving. The Maintenance Supervisor (or Leadworker) would select the General BMPs and the “A Family - Flexible Pavement/Asphalt Paving” Activity Cut-Sheet for review with the work crew.

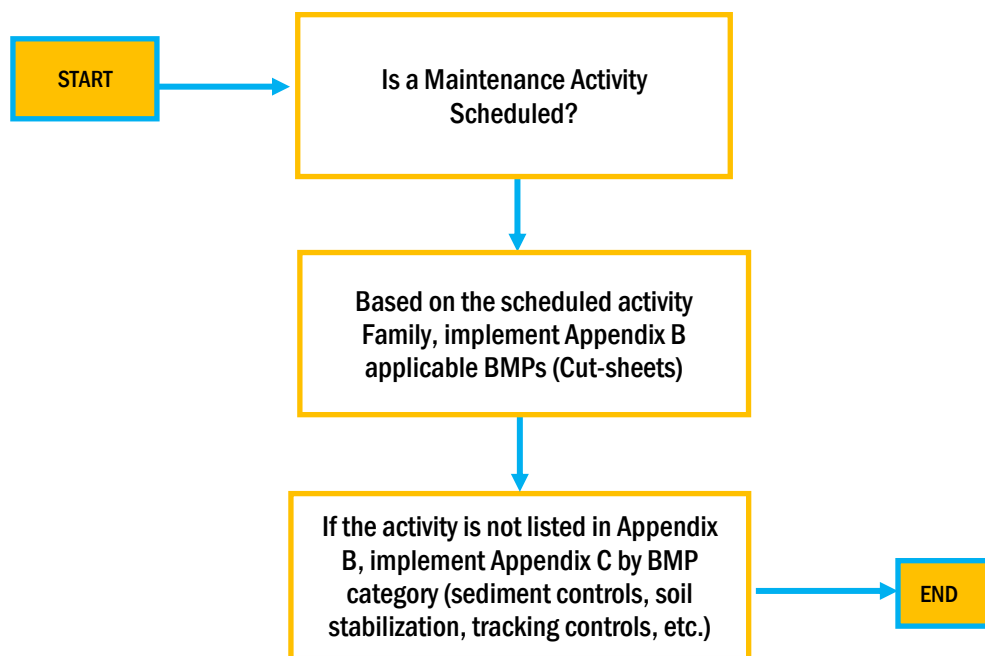

Figure B-1. How to Use Activity Cut Sheets and Maintenance BMPs

If more information or detail is needed beyond the General BMPs and the specific Activity Cut-Sheet, the Supervisor can select and review the individual Maintenance BMPs for an activity or operation provided in Appendix C.

Maintenance BMPs that may be applicable for the operation or activity are shown on a table specified for the operation or activity. Based on the information provided on the table, the individual Maintenance BMPs for an activity or operation are selected and reviewed for applicability. The tables are provided in each Activity Cut-Sheet and are designed to provide a quick reference to the user to locate BMPs in Appendix C.

THIS PAGE INTENTIONALLY LEFT BLANK

# A Family – Flexible Pavement

## Asphalt Cement Crack and Joint Grinding/Sealing



*Sealing operation; no leaks observed*

### Environmental Concerns

Discharge of the following materials into the stormwater drainage system or watercourse:

- Asphalt products
- Emulsion
- Fuel
- Non-stormwater
- Rubberized sealant
- Sediment
- Vehicle fluids

### DEFINITION AND PURPOSE

Crack and joint grinding/sealing involves the sealing and filling of cracks and joints in flexible pavement. This work is done to prevent the entrance of moisture and foreign material into the subgrade, and to maintain the integrity of the pavement surface.

## A FAMILY – FLEXIBLE PAVEMENT

### Asphalt Cement Crack and Joint Grinding/Sealing

#### OPERATIONAL PROCEDURES

The following procedures are used where grinding or sealing may pollute stormwater runoff or discharge to stormwater drainage system and watercourses.

- This activity shall not be performed during rain events or prior to predicted rain events unless required by emergency conditions.
- Protect drains, watercourses and manholes from all potential spills including sealing products.
- Release agents shall not be discharged to the stormwater drainage system or watercourses.
- Minimize airborne dust. Use water spray during grinding but minimize runoff.
- Clean equipment over absorbent pads, drip pans, plastic sheeting or other material to capture all spillage. Properly dispose of all generated waste material.



*Sealing operation; no leaks/drips observed*

#### OPERATIONAL PROCEDURES (CONT'D)

- Do not stockpile sand, sediment or grindings in or near stormwater drainage system or watercourses. Protect stockpiles with a cover and sediment barriers during rainstorms.
- Liquid waste should be collected in a container, with a secure lid or transported to the Maintenance facility to be reused, recycled or disposed of properly.
- Solid waste should be collected by vacuum or sweeping and secured in an appropriate container for transport back to the Maintenance facility to be reused, recycled or disposed of properly.
- At a minimum, shoulder backing placed within 100 feet measured horizontally from a culvert, watercourse, or bridge must not contain reclaimed asphalt concrete. Reuse of asphalt grindings rules are established by the California Department of Fish and Wildlife Memorandum of Understanding (MOU) on the Use of Asphalt (January 12, 1993), the North Coast RWQCB MOU (2010) and the Bay Area RWQCB MOU (2007) (see SWMP Section. 6.8). Talk with your field Supervisor if these rules apply to your worksite.

## A FAMILY – FLEXIBLE PAVEMENT

### Asphalt Cement Crack and Joint Grinding/Sealing

#### Applicable Maintenance BMPs in Appendix C

- Scheduling and Planning, C.3
- Storm Drain Inlet Protection, C.5
- Spill Prevention and Control, C.13.1
- Solid Waste Management, C.13.2
- Hazardous Waste Management, C.13.3
- Sanitary/Septic Waste Management, C.13.5
- Liquid Waste Management, C.13.6
- Vehicle and Equipment Operations, C.15
- Paving Operations Procedures, C.16
- Stockpile Management, C.17
- Safer Alternative Products, C.21
- Illegal Connection and Illicit Discharge (IC/ID), C.22.3
- Illegal Spill Discharge Control, C.22.4
- Sweeping and Vacuuming, C.29

## A FAMILY – FLEXIBLE PAVEMENT

### Asphalt Paving

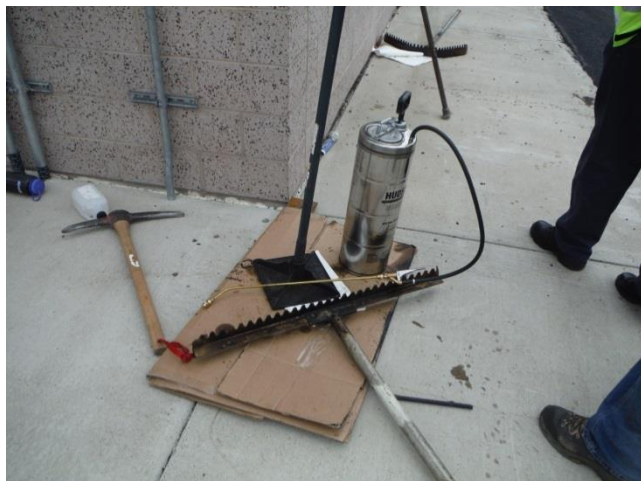

#### Environmental Concerns

Discharge of the following materials into the stormwater drainage system or watercourse:

- Asphalt products
- Cleaning agents
- Fuel
- Non-stormwater
- Sediment
- Vehicle Fluids

*No secondary containment or absorbent pad for release agent*

#### DEFINITION AND PURPOSE

Paving of degraded asphalt surfaces involves patching or resurfacing roadbed with a mineral aggregate and bituminous binder mixture.

#### OPERATIONAL PROCEDURES

The following procedures are used to prevent releases of paving material to stormwater drainage system and watercourses.

- This activity shall not be performed during rain events or prior to predicted rain events unless required by emergency conditions.
- If chemicals are used for cleaning, consider safer alternative products where practical and effective.
- Protect drain inlets, watercourses and manholes from potential spills including paving products and tack coat.
- Release agents shall not be discharged to the stormwater drainage system or watercourses.
- Prevent runoff Minimize water used with the roller and for evaporative cooling of the asphalt.
- Do not stockpile sand or sediment in or near stormwater drainage system or watercourses. Protect stockpiles with a cover or sediment barriers during rainstorms.
- Clean equipment over absorbent pads, drip pans, plastic sheeting or other material to capture all spillage.
- Liquid waste should be collected in a container, with a secure lid, and transported to the Maintenance facility to be reused, recycled or disposed of properly.



## A FAMILY – FLEXIBLE PAVEMENT

### Asphalt Paving

- Solid waste should be collected by vacuum or sweeping and secured in an appropriate container for transport back to the Maintenance facility to be reused, recycled or disposed of properly.
- At a minimum, shoulder backing placed within 100 feet measured horizontally from a culvert, watercourse, or bridge must not contain reclaimed asphalt concrete. Reuse of asphalt grindings rules are established by the California Department of Fish and Wildlife MOU on the Use of Asphalt (January 12, 1993), the North Coast RWQCB MOU (2010) and the Bay Area RWQCB MOU (2007) (see SWMP Section 6.8). Talk with your field Supervisor if these rules apply to your worksite.

#### Applicable Maintenance BMPs in Appendix C

- Scheduling and Planning, C.3
- Storm Drain Inlet Protection, C.5
- Spill Prevention and Control, C.13.1
- Solid Waste Management, C.13.2
- Hazardous Waste Management, C.13.3
- Sanitary/Septic Waste Management, C.13.5
- Liquid Waste Management, C.13.6
- Material Use, C.14.2
- Vehicle and Equipment Operations, C.15
- Paving Operations Procedures, C.16
- Stockpile Management, C.17
- Water Conservation Practice, C.18
- Safer Alternative Products, C.21
- Illegal Connection and Illicit Discharge (IC/ID), C.22.3
- Illegal Spill Discharge Control, C.22.4
- Sweeping and Vacuuming, C.29

## A FAMILY – FLEXIBLE PAVEMENT

### Structural Pavement Failure (Digouts) Pavement Grinding and Paving



*Digout operations*

#### Environmental Concerns

Discharge of the following materials into the stormwater drainage system or watercourse:

- Asphalt products
- Binder
- Cleaning agents
- Concrete
- Fuel
- Non-stormwater
- Sediment
- Vehicle fluids

#### DEFINITION AND PURPOSE

Digouts include major repairs to the structural pavement and require removal of the roadway surface using graders and grinders.

#### OPERATIONAL PROCEDURES

The following procedures are used to prevent release of paving materials and grindings to stormwater drainage system and watercourses.

- This activity shall not be performed during rain events or prior to predicted rain events unless required by emergency conditions.
- Protect drain inlets, watercourses and manholes from potential spills including grindings, paving products and tack coat.
- Place the "cold-mix" asphalt (i.e., pre-mixed aggregate and asphalt binder) under a protective cover during rainstorms.
- Tarp loads before hauling to storage site, if necessary. Do not overfill trucks.
- Prevent runoff, minimize water used with the roller and for evaporative cooling.



*Cold planing operation*

## A FAMILY – FLEXIBLE PAVEMENT

### Structural Pavement Failure (Digouts) Pavement Grinding and Paving

#### OPERATIONAL PROCEDURES (CONT'D)

- Release agents shall not be discharged to the stormwater drainage system or watercourses.
- Minimize airborne dust. Use water spray during grinding but minimize runoff.
- Do not stockpile soil, sediment, asphalt material and asphalt grindings materials or rubble in or near stormwater drainage system or watercourses. Protect stockpiles with a cover and sediment barriers during rainstorms.
- Clean equipment over absorbent pads, drip pans, plastic sheeting or other material to capture all spillage. If chemicals are used for cleaning, consider safer alternative products where practical and effective.
- Liquid waste should be collected in a container with a secure lid and transported to the Maintenance facility to be reused, recycled or disposed of properly.
- Solid waste should be collected by vacuum or sweeping and secured in an appropriate container for transport to the Maintenance facility to be reused, recycled or disposed of properly.
- At a minimum, shoulder backing placed within 100 feet measured horizontally from a culvert, watercourse, or bridge must not contain reclaimed asphalt concrete. Reuse of asphalt grindings rules are established by the California Department of Fish and Wildlife MOU on the Use of Asphalt (January 12, 1993), the North Coast RWQCB MOU (2010) and the Bay Area RWQCB MOU (2007) (see SWMP Section 6.8). Talk with your field Supervisor if these rules apply to your worksite.

#### Applicable Maintenance BMPs in Appendix C

- Scheduling and Planning, C.3
- Storm Drain Inlet Protection, C.5
- Spill Prevention and Control, C.13.1
- Solid Waste Management, C.13.2
- Hazardous Waste Management, C.13.3
- Sanitary/Septic Waste Management, C.13.5
- Liquid Waste Management, C.13.6
- Material Use, C.14.2
- Vehicle and Equipment Operations, C.15
- Paving Operations Procedures, C.16
- Stockpile Management, C.17
- Water Conservation Practice, C.18
- Safer Alternative Products, C.21
- Illegal Connection and Illicit Discharge (IC/ID), C.22.3
- Illegal Spill Discharge Control, C.22.4
- Sweeping and Vacuuming, C.29

## A FAMILY – FLEXIBLE PAVEMENT

### Emergency Pothole Repairs



#### Environmental Concerns

Discharge of the following materials into the stormwater drainage system or watercourse:

- Fuel
- Pothole asphalt material
- Non-stormwater
- Vehicle fluids

*Pothole repair*

#### DEFINITION AND PURPOSE

Unscheduled pothole repairs involve the filling and resurfacing of potholes in flexible pavement portions of roadways to eliminate holes.

#### OPERATIONAL PROCEDURES

The following procedures are used where spilled patch material may pollute stormwater runoff or discharge to stormwater drainage system and watercourses.

- Emergency pothole work is not restricted by rain events or predicted storm events.
- Protect drain inlets, watercourses and manholes from potential spills including patch material.
- Use only enough compacted material to fill the pothole.
- Solid waste should be collected by vacuum or sweeping and secured in an appropriate container for transport to the Maintenance facility to be reused, recycled or disposed of properly.

#### Applicable Maintenance BMPs in Appendix C

- Material Use, C.14.2
- Vehicle and Equipment Operations, C.15
- Safer Alternative Products, C.21

## A FAMILY – FLEXIBLE PAVEMENT

### Sealing Operations



#### Environmental Concerns

Discharge of the following materials into the stormwater drainage system or watercourse:

- Aggregate
- Asphalt products
- Fuel
- Non-stormwater
- Sand
- Sediment
- Vehicle fluids

*Chip seal scheduled during dry weather*

#### DEFINITION AND PURPOSE

Seal coats are required for asphalt pavement due to erosion or oxidation of the road surface. Seal coats include fog seal, sand seal chip seal and slurry seal to reduce road surface permeability and increase traction.

#### OPERATIONAL PROCEDURES

The following procedures are used where sealing materials may pollute stormwater runoff or discharge to stormwater drainage system and watercourses.

- This activity shall not be performed during rain events or prior to predicted rain events unless required by emergency conditions.
- Protect drain inlets, watercourses and manholes from potential spills including sealing products.
- Release agents shall not be discharged to the stormwater drainage system or watercourses.
- Minimize airborne dust. Use water spray during grinding but minimize runoff
- Prevent runoff Minimize water used with the roller.
- Do not stockpile sediment, aggregate, sand or asphalt in or near stormwater drainage system or watercourses. Protect stockpiles with a cover or sediment barriers during rainstorms.
- Clean equipment over absorbent pads, drip pans, plastic sheeting or other material to capture all spillage.
- Liquid waste should be collected in a container with a secure lid and transported to the Maintenance facility to be reused, recycled or disposed of properly.
- Solid waste should be collected by vacuum or sweeping and secured in an appropriate container for transport back to the Maintenance facility to be reused, recycled or disposed of properly.

## A FAMILY – FLEXIBLE PAVEMENT

### Sealing Operations

#### Applicable Maintenance BMPs in Appendix C

- Scheduling and Planning, C.3
- Storm Drain Inlet Protection, C.5
- Spill Prevention and Control, C.13.1
- Solid Waste Management, C.13.2
- Hazardous Waste Management, C.13.3
- Sanitary/Septic Waste Management, C.13.5
- Liquid Waste Management, C.13.6
- Material Use, C.14.2
- Vehicle and Equipment Operations, C.15
- Paving Operations Procedures, C.16
- Stockpile Management, C.17
- Water Conservation Practice, C.18
- Safer Alternative Products, C.21
- Illegal Connection and Illicit Discharge (IC/ID), C.22.3
- Illegal Spill Discharge Control, C.22.4
- Sweeping and Vacuuming, C.29



# B Family – Rigid Pavement

## Portland Cement Crack and Joint Sealing

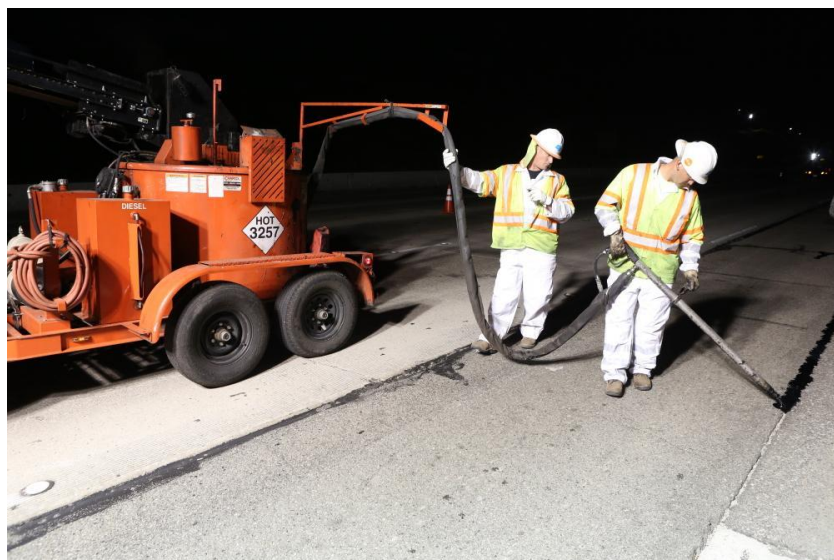

*Joint sealing operations*

### Environmental Concerns

Discharge of the following materials into the stormwater drainage system or watercourse:

- Asphalt products
- Fuel
- Rubberized sealant
- Sand
- Sediment
- Vehicle Fluids

### DEFINITION AND PURPOSE

Crack and joint repair involves the sealing and filling of cracks and joints in rigid pavement. This work is done to prevent the entrance of moisture and foreign material into the subgrade, and to maintain the integrity of the pavement surface.

### OPERATIONAL PROCEDURES

The following procedures are used to prevent releases of sealing material to stormwater drainage system and watercourses.

- This activity shall not be performed during rain events or prior to predicted rain events unless required by emergency conditions.
- Protect drain inlets and manholes from potential spills during sealing operation.
- Release agents shall not be discharged to the stormwater drainage system or watercourses.
- Minimize airborne dust. Use water spray during grinding but minimize runoff.
- Clean equipment over absorbent pads, drip pans, plastic sheeting or other material to capture all spillage.
- Liquid waste should be collected in a container with a secure lid and transported to the Maintenance facility to be reused, recycled or disposed of properly.
- Solid waste should be collected by vacuum or sweeping and secured in an appropriate container for transport to the Maintenance facility to be reused, recycled or disposed of properly.

## B FAMILY – RIGID PAVEMENT

### Portland Cement Crack and Joint Sealing

#### Applicable Maintenance BMPs in Appendix C

- Scheduling and Planning, C.3
- Storm Drain Inlet Protection, C.5
- Spill Prevention and Control, C.13.1
- Solid Waste Management, C.13.2
- Hazardous Waste Management, C.13.3
- Sanitary/Septic Waste Management, C.13.5
- Liquid Waste Management, C.13.6
- Material Use, C.14.2
- Vehicle and Equipment Operations, C.15
- Safer Alternative Products, C.21
- Illegal Connection and Illicit Discharge (IC/ID), C.22.3
- Illegal Spill Discharge Control, C.22.4
- Sweeping and Vacuuming, C.29



## B FAMILY – RIGID PAVEMENT

### Mudjacking and Drilling



#### Environmental Concerns

Discharge of the following materials into the stormwater drainage system or watercourse:

- Concrete
- Fuel
- Non-stormwater
- Sediment
- Slurry
- Vehicle Fluids

#### *Mudjacking operations*

#### DEFINITION AND PURPOSE

Mudjacking is used to maintain and repair rigid type surfacing, its associated base and any Portland concrete cement shoulders less than two feet in width. A Portland cement and pozzolan grout mixture is pumped below the slab (i.e., mudjacking) to replace lost or settled base material.

#### OPERATIONAL PROCEDURES

The following procedures are used to prevent releases of grout material to stormwater drainage system and watercourses.

- This activity shall not be performed during rain events or prior to predicted rain events unless required by emergency conditions.
- Prevent spills. Secure vehicle loads and cover loose materials in open bed vehicles.
- Protect drain inlets, watercourses and manholes from potential spills including grout, slurries and concrete washout.
- Water applied during the drilling and pumping must be controlled to prevent non-stormwater discharges.
- Grout and slurries shall not be discharged to the stormwater drainage system or watercourses.
- Vehicle and equipment washing is only allowed at designated rinsing areas, wash racks or other designated areas. All engine compartment and undercarriage rinsing/washing must be performed within a wash rack facility. The District Maintenance Stormwater Coordinator will approve or provide input on the approved location for a designated rinsing area.
- Liquid waste and concrete washout should be collected in a container with a secure lid and transported to the Maintenance facility or decanting area for proper disposal. Concrete contractors are required to comply with Caltrans Standard Specification Section 13-9 Temporary Concrete Washouts.

## B FAMILY – RIGID PAVEMENT

### Mudjacking and Drilling

- Solid waste should be collected by vacuum or sweeping and secured in an appropriate container for transport to the Maintenance facility to be reused, recycled or disposed of properly.

#### Applicable Maintenance BMPs in Appendix C

- Scheduling and Planning, C.3
- Storm Drain Inlet Protection, C.5
- Spill Prevention and Control, C.13.1
- Solid Waste Management, C.13.2
- Hazardous Waste Management, C.13.3
- Sanitary/Septic Waste Management, C.13.5
- Liquid Waste Management, C.13.6
- Concrete Waste Management, C.13.7
- Material Use, C.14.2
- Vehicle and Equipment Operations, C.15
- Water Conservation Practice, C.18
- Safer Alternative Products, C.21
- Illegal Connection and Illicit Discharge (IC/ID), C.22.3
- Illegal Spill Discharge Control, C.22.4
- Sweeping and Vacuuming, C.29

## B FAMILY – RIGID PAVEMENT

### Concrete Slab and Spall Repair



Concrete slab repair

#### Environmental Concerns

Discharge of the following materials into the stormwater drainage system or watercourse:

- Concrete
- Fuel
- Non-stormwater
- Sediment
- Slurry
- Vehicle Fluids

#### DEFINITION AND PURPOSE

Spalling, slab cracking and settlement are common problems associated with Portland cement concrete pavement that require repairs.

#### OPERATIONAL PROCEDURES

The procedures are used to prevent releases of concrete wastes (e.g., concrete grindings and cuttings, concrete washout) to stormwater drainage system and watercourses.

- Slab repairs shall not be performed during rain events or prior to predicted rain events unless required by emergency conditions.
- Protect drain inlets, watercourses and manholes from potential spills including concrete products and concrete waste.
- When using release agents (e.g., citrus, soy-based) for cleaning or coating equipment and tools, all products and by-products shall be captured and reused, recycled or properly disposed.
- Release agents shall not be discharged to the stormwater drainage system or watercourses.
- Minimize airborne dust. Use water spray during grinding but minimize/collect runoff
- Minimize amount of water used to clean and cure concrete to prevent runoff
- Do not stockpile sediment, concrete grindings and cuttings in or near stormwater drainage system or watercourses.

## B FAMILY – RIGID PAVEMENT

### Concrete Slab and Spall Repair

#### OPERATIONAL PROCEDURES (CONT'D)

- Vehicle and equipment washing is allowed only at designated rinsing areas, wash racks or other designated areas. All engine compartment and undercarriage rinsing/washing must be performed within a wash rack facility. The District Maintenance Stormwater Coordinator will approve or provide input on the approved location for a designated rinsing area.
- Liquid waste and concrete washout should be collected in a container with a secure lid and transported to the Maintenance facility or decanting area for proper disposal. Concrete contractors are required to comply with Caltrans Standard Specification Section 13-9 Temporary Concrete Washouts.
- Solid waste should be collected by vacuum or sweeping and secured in an appropriate container for transport to the Maintenance facility to be reused, recycled or disposed of properly.

#### Applicable Maintenance BMPs in Appendix C

- Scheduling and Planning, C.3
- Storm Drain Inlet Protection, C.5
- Spill Prevention and Control, C.13.1
- Solid Waste Management, C.13.2
- Hazardous Waste Management, C.13.3
- Sanitary/Septic Waste Management, C.13.5
- Liquid Waste Management, C.13.6
- Concrete Waste Management, C.13.7
- Material Use, C.14.2
- Vehicle and Equipment Operations, C.15
- Stockpile Management, C.17
- Water Conservation Practice, C.18
- Safer Alternative Products, C.21
- Illegal Connection and Illicit Discharge (IC/ID), C.22.3
- Illegal Spill Discharge Control, C.22.4
- Sweeping and Vacuuming, C.29

# C Family – Slope/Drains/Vegetation

## Shoulder Grading



*Shoulder grading*

### Environmental Concerns

Discharge of the following materials into the stormwater drainage system or watercourse:

- Aggregate
- Asphalt products
- Fuel
- Non-stormwater
- Sediment
- Vehicle Fluids

### DEFINITION AND PURPOSE

Areas adjacent to surfaced and unsurfaced road shoulders require maintenance to prevent the loss of lateral support, to prevent the deterioration or failure of the road edge and to maintain roadside drainage patterns.

## C FAMILY – SLOPE/DRAINS/VEGETATION

### Shoulder Grading

#### OPERATIONAL PROCEDURES

The following procedures are used to prevent releases of sediment and equipment fluids to stormwater drainage system and watercourses.

- This activity shall not be performed during rain events or prior to predicted rain events unless required by emergency conditions.
- Tarp imported fill material and other materials that may drift when transporting them to the work area in open-bed trucks. Do not overfill trucks.
- Protect drain inlets, watercourses and manholes from potential spills including sediment, aggregate and asphalt grindings.
- Compact unpaved shoulder as soon as possible after grading. Use water to aid compaction, but prevent runoff
- Prevent runoff. Water applied during sweeping operations must be controlled to prevent unauthorized non-stormwater discharges.
- Control dust and erosion in windy or wind-prone areas using covers, water or soil stabilizers.
- Preserve existing vegetation by defining the work area and following the existing contours. Replace any damaged vegetation outside the defined work area.

#### OPERATIONAL PROCEDURES (CONT'D)

- Do not stockpile sediment, aggregate and asphalt grindings in or near stormwater drainage system or watercourses. Protect stockpiles with a cover or sediment barriers during rainstorms.
- Vehicle and equipment washing is allowed only at designated rinsing areas, wash racks or other designated areas. All engine compartment and undercarriage rinsing/washing must be performed within a wash rack facility. The District Maintenance Stormwater Coordinator will approve or provide input on the approved location for a designated rinsing area.
- Prevent sediment runoff from equipment rinsing from discharging to the stormwater drainage system or watercourses.
- Reuse of asphalt grindings rules are established by the California Department of Fish and Wildlife MOU on the Use of Asphalt (January 12, 1993), the North Coast RWQCB MOU (2010) and the Bay Area RWQCB MOU (2007). Talk with your field Supervisor if these rules apply to your work site.
- Sweep up or vacuum sediment and excess asphalt. Keep asphalt grindings out of the stormwater drainage system and watercourses. Incorporate back into the work area or properly dispose of all generated materials.
- Talk to your field Supervisor about special debris and sediment management requirements near water bodies (i.e., CWA 303(d), ASBS).



## C FAMILY – SLOPE/DRAINS/VEGETATION

### Shoulder Grading

#### Applicable Maintenance BMPs in Appendix C

- Scheduling and Planning, C.3
- Storm Drain Inlet Protection, C.5
- Compaction, C.7.1
- Preservation of Existing Vegetation, C.8
- Wind Erosion Control, C.11
- Spill Prevention and Control, C.13.1
- Solid Waste Management, C.13.2
- Material Use, C.14.2
- Vehicle and Equipment Operations, C.15
- Stockpile Management, C.17
- Water Conservation Practice, C.18
- Illegal Connection and Illicit Discharge (IC/ID), C.22.3
- Illegal Spill Discharge Control, C.22.4
- Sweeping and Vacuuming, C.29

## C FAMILY – SLOPE/DRAINS/VEGETATION

### Non-Landscaped Chemical Vegetation Control



#### Environmental Concerns

Discharge of the following materials into the stormwater drainage system or watercourse:

- Fuel
- Non-stormwater
- Pesticides
- Sediment
- Vehicle Fluids

*Roadside herbicide application*

#### DEFINITION AND PURPOSE

This method of vegetation control uses pesticides (e.g., herbicides, pre-emergents) to eliminate and prevent the growth of undesirable vegetation within the highway right-of-way. Chemical vegetation controls are used to protect preferred vegetation, to maintain unobstructed views of the road edge and traffic safety devices, to provide fire protection and to improve roadside appearance. The activity includes the operation of support equipment, mixing and loading chemicals and chemical application to native vegetation.

#### OPERATIONAL PROCEDURES

The following procedures are used to prevent releases of pesticides, sediment and equipment fluids to stormwater drainage system and watercourses.

Vegetation management can result in reduced erosion control effectiveness. BMP implementation will depend on traffic, weather, available resources and safety conditions.

- This activity shall not be performed during rain events or prior to predicted rain events that produce runoff unless required by emergency conditions.
- A licensed Agricultural Pest Control Adviser (PCA) should approve the activities.
- Identify drain inlets and watercourses, both upstream and downstream of the activity site. Protect the drain inlets, stormwater drainage system and watercourses from discharges of potential pollutants.
- Mixing and loading into spray equipment should be in a containment area away from drain inlets and watercourses.



## C FAMILY – SLOPE/DRAINS/VEGETATION

### Non-Landscaped Chemical Vegetation Control

#### OPERATIONAL PROCEDURES (CONT'D)

- Apply pesticides in compliance with federal, state and local pesticide use regulations as recommended by the District Annual Vegetation Control Plan. Apply pesticides only as specified on the "Pesticide Use Recommendation" on the label and as approved by the PCA.
- Minimize the use of pesticides in or near stormwater drainage system or watercourses.
- Calibrate the spray rig to ensure accurate application of pesticides.
- Do not spray chemicals if there is a 50% or greater likelihood that 0.10 inch or more of precipitation will fall within a 24-hour period, as predicted by NOAA at: <http://www.wrh.noaa.gov/forecast/wxtables/index.php?wfo=sto>
- Water used for chemical mixing or in application must be controlled to prevent unauthorized non-stormwater discharges.
- Preserve existing vegetation by defining the work area and replacing the damaged vegetation outside the defined work area.

#### Applicable Maintenance BMPs in Appendix C

- Scheduling and Planning, C.3
- Storm Drain Inlet Protection, C.5
- Preservation of Existing Vegetation, C.8
- Spill Prevention and Control, C.13.1
- Material Use, C.14.2
- Vehicle and Equipment Operations, C.15
- Water Conservation Practice, C.18
- Safer Alternative Products, C.21
- Illegal Connection and Illicit Discharge (IC/ID), C.22.3
- Illegal Spill Discharge Control, C.22.4
- Chemical Vegetation Control, C.25

## C FAMILY – SLOPE/DRAINS/VEGETATION

### Non-Landscaped Mechanical Vegetation Control/Mowing



#### Environmental Concerns

Discharge of the following materials into the stormwater drainage system or watercourse:

- Fuel
- Non-stormwater
- Sediment
- Vegetation debris
- Vehicle fluids

*Mowing operation*

#### DEFINITION AND PURPOSE

Mechanical vegetation control includes the removal of grass and weeds within the highway right-of-way using machinery and mobile equipment. The purpose is to control grass and weeds to improve roadside appearance and provide fire control.

#### OPERATIONAL PROCEDURES

The following procedures are used to prevent releases of sediment and equipment fluids to stormwater drainage system and watercourses.

Vegetation management can result in reduced erosion control effectiveness. BMP implementation will depend on traffic, weather, available resources and safety conditions.

- Protect drain inlets and watercourses from potential spills and vegetative debris.
- Do not fuel equipment near drain inlets or watercourses.
- Keep vegetation and clippings out of the stormwater drainage system and watercourses. Solid waste should be disposed of properly.
- Prevent runoff. Sediment runoff from equipment rinsing shall not be discharged to the stormwater drainage system or watercourses. Consider using backpack blowers to remove debris accumulation from vehicles and equipment.
- Preserve existing vegetation by defining the work area and replacing the damaged vegetation outside the defined work area.

## C FAMILY – SLOPE/DRAINS/VEGETATION

### Non-Landscaped Mechanical Vegetation Control/Mowing

#### Applicable Maintenance BMPs in Appendix C

- Scheduling and Planning, C.3
- Preservation of Existing Vegetation, C.8
- Spill Prevention and Control, C.13.1
- Solid Waste Management, C.13.2
- Vehicle and Equipment Operations, C.15
- Illegal Connection and Illicit Discharge (IC/ID), C.22.3
- Illegal Spill Discharge Control, C.22.4

## C FAMILY – SLOPE/DRAINS/VEGETATION

### Non-Landscaped Tree and Shrub Pruning, Brush Chipping, Tree and Shrub Removal



*Tree trimming crew*

#### Environmental Concerns

Discharge of the following materials into the stormwater drainage system or watercourse:

- Fuel
- Non-stormwater
- Sawdust
- Sediment
- Vegetation debris
- Vehicle fluids
- Wood
- Wood mulch

#### DEFINITION AND PURPOSE

Trees and shrubs are pruned to preserve their health, remove dead branches, protect utilities, maintain sight distances, preserve aesthetics and prevent property damage.

#### OPERATIONAL PROCEDURES

The following procedures are used to prevent releases of removed vegetation and equipment fluids to stormwater drainage system and watercourses.

Vegetation management can result in reduced erosion control effectiveness. BMP implementation will depend on traffic, weather, available resources and safety conditions.

- Protect drain inlets and watercourses from potential spills and vegetative debris.
- Do not fuel equipment near drain inlets or watercourses.
- Keep vegetation debris, clippings and mulch out of the stormwater drainage system and watercourses. Brush cuttings chipped into wood mulch should not be used at locations prone to washout.
- Preserve existing vegetation by defining the work area and replacing the damaged vegetation outside the defined work area.
- Prevent runoff. Sediment from equipment rinsing shall not be discharged to the stormwater drainage system or watercourses. Consider using backpack blowers to remove debris accumulation from vehicles and equipment.
- Do not stockpile prunings and clippings in or near stormwater drainage system or watercourses.

## C FAMILY – SLOPE/DRAINS/VEGETATION

### Non-Landscaped Tree and Shrub Pruning, Brush Chipping, Tree and Shrub Removal

- Brush cuttings that are not chipped should be transported to the maintenance facility for proper disposal.

#### Applicable Maintenance BMPs in Appendix C

- Scheduling and Planning, C.3
- Storm Drain Inlet Protection, C.5
- Preservation of Existing Vegetation, C.8
- Spill Prevention and Control, C.13.1
- Solid Waste Management, C.13.2
- Sanitary/Septic Waste Management, C.13.5
- Vehicle and Equipment Operations, C.15
- Stockpile Management, C.17
- Illegal Connection and Illicit Discharge (IC/ID), C.22.3
- Illegal Spill Discharge Control, C.22.4

## C FAMILY – SLOPE/DRAINS/VEGETATION

### Fence Repair



#### Environmental Concerns

Discharge of the following materials into the stormwater drainage system or watercourse:

- Concrete
- Fuel
- Litter and debris
- Metal Debris
- Non-stormwater
- Vehicle fluids

*Cleanup and fence repair work*

#### DEFINITION AND PURPOSE

Fences provide a physical barrier to control access and prevent crossing by vehicles or pedestrians. The three categories include freeway and right-of-way fences, property fences and median fences.

#### OPERATIONAL PROCEDURES

The following procedures are used to prevent releases of concrete, metal debris and equipment fluids to stormwater drainage system and watercourses.

- Protect drain inlets and watercourses from potential spills and from sediment for post-hole drilling.
- Stabilize the entrance/exits to the work area if necessary to avoid tracking mud or sediment on to public roads.
- Preserve existing vegetation by defining the work area and replacing the damaged vegetation outside the defined work area.
- Equipment and tools can be cleaned on a mud rinse pad at the Maintenance facility. If a washout needs to occur at the activity site, make sure all liquids are contained and disposed of properly.
- If concrete is used, do not allow concrete waste or slurry to enter stormwater drainage system or watercourses. Liquid waste and concrete washout should be collected in a container with a secure lid and transported to the Maintenance facility to be reused, recycled or disposed of properly. Concrete contractors are required to comply with Caltrans Standard Specification Section 13-9 Temporary Concrete Washouts.
- Sweep or vacuum roadway. If working off-road, inspect and remove rock and sediment from tires prior to leaving the site to reduce the potential of tracking litter, debris and sediment onto public roadways.

## C FAMILY – SLOPE/DRAINS/VEGETATION

### Fence Repair

#### OPERATIONAL PROCEDURES (CONT'D)

- Solid waste should be collected and secured in an appropriate container for transport to the Maintenance facility to be reused, recycled or disposed of properly.

#### Applicable Maintenance BMPs in Appendix C

- Scheduling and Planning, C.3
- Storm Drain Inlet Protection, C.5
- Compaction, C.7.1
- Stabilized Activity Entrance/Exit, C.12.1
- Tire Inspection and Sediment Removal, C.12.2
- Solid Waste Management, C.13.2
- Material Use, C.14.2
- Vehicle and Equipment Operations, C.15
- Illegal Connection and Illicit Discharge (IC/ID), C.22.3
- Illegal Spill Discharge Control, C.22.4



## C FAMILY – SLOPE/DRAINS/VEGETATION

### Drainage Ditch and Channel Maintenance



*Gravel bag berm protection at concrete-lined channel*

#### Environmental Concerns

Discharge of the following materials into the stormwater drainage system or watercourse:

- Concrete
- Fuel
- Litter and debris
- Non-stormwater
- Sediment
- Vehicle fluids

#### DEFINITION AND PURPOSE

Ditches and channels are maintained to avoid obstruction and maintain flow. Fill material may be imported to repair eroded channel walls. Select backfill may be accepted provided it is free of contamination, vegetation and debris.

#### OPERATIONAL PROCEDURES

The following procedures are used to prevent releases of sediment and equipment fluids to stormwater drainage system and watercourses.

- Check with the field Supervisor if these are in your work area:
  - Before work begins, determine what regulatory permits or approvals are required.
  - Clean drainage inlets adjacent to ASBS locations that discharge to Waters of the State or Waters of the United States.
  - There are special maintenance activities for Biofiltration Strips and Swales; see Appendix C – Biofiltration Strips and Swales BMP.
  - Clean drainage inlets in areas prone to erosion within 200 feet of sediment-impaired a 303(d) waterbody.
- Inspect ditches and channels for sufficient flow capacity and damage. Clean during the dry or low-flow season, if possible. If chemical contamination is suspected, stop work and notify the Supervisor for further instructions.
- Tarp loads before hauling to and from the site if necessary. Do not over-fill trucks.
- Stabilize the entrance/exists to the work area and the erodible ground surface adjacent to the ditch and channel using soil stabilization BMPs requiring protection as soon as possible after completing ditch and channel maintenance. Compact soil if re-vegetation is not desired.



## C FAMILY – SLOPE/DRAINS/VEGETATION

### Drainage Ditch and Channel Maintenance

- Minimize water quality degradation and maintain a sufficient water flow downstream to maintain aquatic life. Divert the water flow around the work area. Remove diversions when the maintenance activity is completed.
- When cleaning ditches and channels below cut slopes or steep slopes, avoid cutting the toe of the slope.
- Check dams may be used to restrict water flow. Remove the check dams and accumulated sediment when the activity is completed.
- Use drip pans and absorbents to contain equipment fluids such as fuels and hydraulic oils.
- Contain the water used, materials and soil generated during ditch and channel cleaning and manage as liquid or solid waste. Noncontaminated soil may be acceptable for reuse if approved.
- Preserve existing vegetation by defining the work area and replacing the damaged vegetation outside the defined work area.
- Control dust and erosion in windy or wind-prone areas using covers, water or soil stabilizers.
- Do not stockpile sediment in or near the stormwater drainage system or watercourses.
- The District Maintenance Stormwater Coordinator will provide written instructions for pre-approved decanting sites for liquid waste and the proper disposal site for contaminated soil.
- Vehicle and equipment washing is allowed only at District-designated rinsing areas, wash racks or other designated areas. All engine compartment and undercarriage rinsing/washing must be performed within a wash rack facility. The District Maintenance Stormwater Coordinator will approve or provide input on the approved location for a designated rinsing area.
- Liquid waste may be collected in a Vactor® and transported to the Maintenance facility or decanting area for proper disposal.
- If working off-road, inspect and remove rock and sediment from tires prior to leaving the site to reduce the potential of tracking litter, debris and sediment onto public roadways

## C FAMILY – SLOPE/DRAINS/VEGETATION

### Drainage Ditch and Channel Maintenance

#### Applicable Maintenance BMPs in Appendix C

- Scheduling and Planning, C.3
- Sediment Control, C.4
- Storm Drain Inlet Protection, C.5
- Compaction, C.7.1
- Clear-Water Diversion, C.9
- Hydroseeding/Handseeding, C.7.4
- Geotextiles, Mats/Plastic Covers and Erosion Control Blankets, C.7.7
- Preservation of Existing Vegetation, C.8
- Stabilized Activity Entrance/Exit, C.12.1
- Tire Inspection and Sediment Removal, C.12.2
- Solid Waste Management, C.13.2
- Concrete Waste Management, C.13.7
- Contaminated Soil Management, C.13.4
- Liquid Waste Management, C.13.6
- Material Use, C.14.2
- Vehicle and Equipment Operations, C.15
- Stockpile Management, C.17
- Baseline Stormwater Drainage Facilities Inspection and Cleaning, C.22.1
- Illegal Connection and Illicit Discharge (IC/ID), C.22.3
- Illegal Spill Discharge Control, C.22.4

## C FAMILY – SLOPE/DRAINS/VEGETATION

### Drain and Culvert Maintenance



*Culvert damaged scheduled for repair*

#### Environmental Concerns

Discharge of the following materials into the stormwater drainage system or watercourse:

- Concrete
- Fuel
- Litter and debris
- Non-stormwater
- Sediment
- Vehicle fluids

#### DEFINITION AND PURPOSE

This activity includes the maintenance of culverts, under drains, horizontal drains, down drains, gutters, overside drains, scuppers and deck drains. Drains are maintained to prevent flooding and allow unobstructed flow. <sup>1</sup>

#### OPERATIONAL PROCEDURES

The following procedures are used to prevent releases of sediment and equipment fluids to stormwater drainage system and watercourses.

BMP implementation will depend on traffic, weather, available resources and safety conditions. Access to the storm water drainage system and worker safety may limit inspection and cleaning.

- Before working on drain and culvert maintenance, determine what regulatory permits or approvals are required.
- Clean drainage inlets adjacent to ASBS that discharge to Waters of the State or Waters of the United States. Check with the field Supervisor if these are in your work area.



*Culvert scheduled for cleaning*

<sup>1</sup> An annual storm drain inlet inspection and cleaning program is implemented in the metropolitan areas of San Diego, Orange, Los Angeles and Ventura Counties mandated by court order. These areas follow the Enhanced Storm Drain Inlet Inspection and Cleaning Program BMP.

## C FAMILY – SLOPE/DRAINS/VEGETATION

### Drain and Culvert Maintenance

#### OPERATIONAL PROCEDURES (CONT'D)

- Clean drainage inlets in areas prone to erosion within 200 feet of sediment-impaired a 303(d) water body. Check with the field Supervisor if these are in your work area.
- Inspect drains and culverts for sufficient flow capacity and damage. Clean during the dry or low-flow season, if possible. If chemical contamination is suspected, stop work and notify the Supervisor for further instructions
- Keep the gearbox of equipment above water when equipment is in a water body.
- Construct a barrier to intercept sediment from discharging into stormwater drainage system or watercourses. Remove the barriers when the maintenance activity is completed.
- Stabilize the entrance/exits to the work area as necessary to avoid tracking mud or sediments onto public roadways
- Use the minimum amount of water to clear drains and culverts. Water applied during cleaning operations must be controlled to prevent unauthorized non-stormwater discharges.
- Preserve existing vegetation by defining the work area and replacing the damaged vegetation outside the defined work area.
- Stabilize ground surfaces that require erosion protection as soon as possible after completing drain and culvert maintenance. Compact soil if revegetation is not desired.
- Do not stockpile sediment in or near the stormwater drainage system or watercourses.
- Vehicle and equipment washing is allowed only at designated rinsing areas, wash racks or other designated areas. All engine compartment and undercarriage rinsing/washing must be performed within a wash rack facility. The District Maintenance Stormwater Coordinator will approve or provide input on the approved location for a designated rinsing area.
- Contain the water used and materials generated during drain and culvert cleaning and managed as liquid or solid waste. The District Supervisor and District Maintenance Stormwater Coordinator or Manager will provide written instruction for pre-approved decanting sites for liquid waste and the proper disposal site for contaminated soil.
- If working off-road, inspect and remove rock and sediment from tires prior to leaving the site to reduce the potential of tracking litter, debris, and sediment onto public roadways.
- Liquid waste may be collected in a Vactor® and transported back to the Maintenance facility or decanting area for proper disposal.

## C FAMILY – SLOPE/DRAINS/VEGETATION

### Drain and Culvert Maintenance

#### Applicable Maintenance BMPs in Appendix C

- Scheduling and Planning, C.3
- Sediment Control, C.4
- Compaction, C.7.1
- Hydroseeding/Handseeding, C.7.4
- Preservation of Existing Vegetation, C.8
- Stabilized Activity Entrance/Exit, C.12.1
- Tire Inspection and Sediment Removal, C.12.2
- Contaminated Soil Management, C.13.4
- Solid Waste Management, C.13.2
- Sanitary/Septic Waste Management, C.13.5
- Liquid Waste Management, C.13.6
- Concrete Waste Management, C.13.7
- Vehicle and Equipment Operation, C.15
- Stockpile Management, C.17
- Water Conservation Practice, C.18
- Baseline Stormwater Drainage Facilities Inspection and Cleaning, C.22.1
- Enhanced Storm Drain Inlet Inspection and Cleaning Program, C.22.2
- Illegal Connection and Illicit Discharge (IC/ID), C.22.3
- Illegal Spill Discharge Control, C.22.4

## C FAMILY – SLOPE/DRAINS/VEGETATION

### Curb and Sidewalk Repair



#### Environmental Concerns

Discharge of the following materials into the stormwater drainage system or watercourse:

- Concrete
- Fuel
- Litter and debris
- Non-stormwater
- Sediment
- Slurry
- Vehicle fluids

Curb and sidewalk repairs in progress

#### DEFINITION AND PURPOSE

This activity includes repairs made to concrete curbs and sidewalks for the traveling motorists and pedestrians.

#### OPERATIONAL PROCEDURES

The following procedures are used to prevent releases of sediment, concrete materials and equipment fluids to stormwater drainages system and watercourses.

- This activity shall not be performed during rain events or prior to predicted rain events unless required by emergency conditions.
- Protect drain inlets, watercourses and manholes from potential spills including sediment, aggregate, grindings, concrete products and concrete waste.
- Release agents shall not be discharged to the stormwater drainage system or watercourses.
- Minimize amount of water used to clean and cure concrete to prevent runoff.
- Minimize airborne dust. Use water spray during grinding but minimize runoff.
- Do not stockpile sediment or concrete rubble in or near stormwater drainage system or watercourses. Protect stockpiles with a cover or sediment barriers during rainstorms.
- Vehicle and equipment washing is only allowed at designated rinsing areas, wash racks or other designated areas. All engine compartment and undercarriage rinsing/washing must be performed within a wash rack facility. The District Maintenance Stormwater Coordinator will approve or provide input on the approved location for a designated rinsing area.
- Liquid waste and concrete washout should be collected in a container with a secure lid and transported to the Maintenance facility or decanting area for proper disposal. Concrete contractors are required to comply with Caltrans Standard Specification Section 13-9 Temporary Concrete Washouts.



## C FAMILY – SLOPE/DRAINS/VEGETATION

### Curb and Sidewalk Repair

#### OPERATIONAL PROCEDURES (CONT'D)

- Solid waste should be collected by vacuum or sweeping and secured in an appropriate container for transport to the Maintenance facility to be reused, recycled or disposed of properly.

#### Applicable Maintenance BMPs in Appendix C

- Scheduling and Planning, C.3
- Storm Drain Inlet Protection, C.5
- Liquid Waste Management, C.13.6
- Concrete Waste Management, C.13.7
- Spill Prevention and Control, C.13.1
- Solid Waste Management, C.13.2
- Hazardous Waste Management, C.13.3
- Material Use, C.14.2
- Vehicle and Equipment Operations, C.15
- Stockpile Management, C.17
- Water Conservation Practice, C.18
- Safer Alternative Products, C.21
- Illegal Connection and Illicit Discharge (IC/ID), C.22.3
- Illegal Spill Discharge Control, C.22.4
- Sweeping and Vacuuming, C.29

# D Family – Litter/Debris/Graffiti

## Sweeping Operations



*Cleaning out sweepers at end of shift*

### Environmental Concerns

Discharge of the following materials into the stormwater drainage system or watercourse:

- Fuel
- Litter and debris
- Non-stormwater
- Sediment
- Vehicle fluids

### DEFINITION AND PURPOSE

Sweeping operations remove litter and debris from the traveled way and shoulder to prevent the collection of materials in drain inlets, reduce the sediment loading of culverts, reduce traffic hazards and improve aesthetics.

### OPERATIONAL PROCEDURES

The following procedures are used to prevent releases of sediment and equipment fluids to stormwater drainage system and watercourses.

- Do not load hoppers beyond their capacity.
- Adjust brooms frequently for maximum efficiency.
- Do not discharge fluids from sweeping operation to stormwater drainage system or watercourses.
- Prevent sediment runoff from equipment rinsing shall not be discharged to the stormwater drainage system or watercourses. Rinse sediment in designated rinsing areas to prevent discharge to the stormwater drainage system or watercourses.
- Do not sweep any unknown substances that may be potentially hazardous.

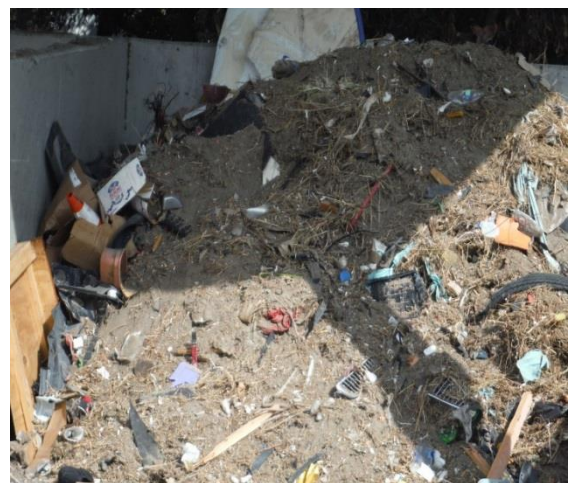



## D FAMILY – LITTER/DEBRIS/GRAFFITI

### Sweeping Operations

#### OPERATIONAL PROCEDURES (CONT'D)

- Before deadheading the sweeper, stow gutter brooms, but keep the pickup broom down for approximately 150 feet. Lift the pickup broom, and to the maximum extent possible, clear the sweeper's brooms and elevators before merging onto the public roadway or highway.
- Do not stockpile sediment in or near storm drainage system or watercourses. Protect stockpiles with a cover or sediment barriers during rainstorms.
- Sweeper waste should be transported back to the Maintenance facility or temporary pre-designated location to be reused, recycled or disposed of properly.

#### Applicable Maintenance BMPs in Appendix C

- Scheduling and Planning, C.3
- Solid Waste Management, C.13.2
- Liquid Waste Management, C.13.6
- Vehicle and Equipment Operations, C.15
- Stockpile Management, C.17
- Water Conservation Practice, C.18
- Safer Alternative Products, C.21
- Illegal Connection and Illicit Discharge (IC/ID), C.22.3
- Illegal Spill Discharge Control, C.22.4
- Sweeping and Vacuuming, C.29

## D FAMILY – LITTER/DEBRIS/GRAFFITI

### Litter and Debris Removal



*Homeless encampment trash and debris*

#### Environmental Concerns

Discharge of the following materials into the stormwater drainage system or watercourse:

- Fuel
- Litter and debris
- Non-stormwater
- Sediment
- Vehicle fluids

#### DEFINITION AND PURPOSE

Litter and debris are periodically collected from the Department's rights-of-way and removed from drainage grates, trash racks and ditch lines.

#### OPERATIONAL PROCEDURES

The following procedures are used where litter and debris may pollute stormwater runoff or discharge to stormwater drainage system and watercourses.

- Tarp or secure materials transported in open-bed trucks to and from the work area to prevent spillage to the roadway. Do not overfill truck.
- Supervisors should observe the overall condition of their assigned sections and assess the need for litter removal and installation of anti-litter signs.
- Pick up litter as needed or at the assigned frequencies.
- Remove litter and debris from drainage grates, trash racks and ditch lines that have the potential to reduce flows in stormwater drainage systems.
- Litter and debris should be removed using dry techniques.
- Solid waste should be put into bags or buckets and secured for transport to the Maintenance facility to be reused, recycled or disposed of properly.
- Animal carcasses shall not be relocated to or disposed of within 150 feet of waterways or drainage ways that lead directly to waterways, or buried within five (5) feet of groundwater. Area Superintendents provide guidelines of animal carcass disposal in their area.
- Do not pick up or handle unmarked containers that may have contaminated materials inside.
- Inspect and replace unreadable anti-litter signs.

## D FAMILY – LITTER/DEBRIS/GRAFFITI

### Litter and Debris Removal

#### Applicable Maintenance BMPs in Appendix C

- Scheduling and Planning, C.3
- Solid Waste Management, C.13.2
- Sanitary/Septic Waste Management, C.13.5
- Vehicle and Equipment Operations, C.15
- Water Conservation Practice, C.18
- Illegal Connection and Illicit Discharge (IC/ID), C.22.3
- Illegal Spill Discharge Control, C.22.4
- Litter and Debris, C.24.1
- Anti-Litter Signs, C.24.2
- Sweeping and Vacuuming, C.29

## D FAMILY – LITTER/DEBRIS/GRAFFITI

### Emergency Response and Cleanup Practices



*Emergency response to a Hazmat incident*

#### Environmental Concerns

Discharge of the following materials into the stormwater drainage system or watercourse:

- Debris
- Fuel
- Materials
- Non-stormwater
- Sediment
- Unknown materials
- Vehicle fluids

#### DEFINITION AND PURPOSE

After proper identification and hazard assessment, emergency response and cleanup includes the isolation, containment, removal and disposal of spilled substances on highway rights-of-way. Proper containment and clean-up of spilled material, will reduce the discharge of potential pollutants to the stormwater drainage system and watercourses.

#### OPERATIONAL PROCEDURES

The following procedures are used where hazardous substances may pollute stormwater runoff or discharge to stormwater drainage system and watercourses.

The BMPs presented for this activity only provide operating methods or measures for the purpose of stormwater pollution prevention. The applicable local, state and federal hazardous materials, hazardous waste and employee safety requirements are not present. All emergency response and cleanup practices must comply with the requirements of Chapter D5 of the Maintenance Manual, Vol. 1.

- Protect drain inlets and manholes from receiving waste from spills, if it can be done safely.
- Stabilize the entrance/exits to the work area if necessary to avoid tracking mud or sediment on to public roadways.
- Water used for cleaning and non-emergency decontamination shall not be allowed to enter stormwater drainage system or watercourses. However, first responders should undertake any necessary emergency actions to save lives and protect the public and themselves.

## D FAMILY – LITTER/DEBRIS/GRAFFITI

### Emergency Response and Cleanup Practices

- Do not track spilled material. Without compromising safety or cleanup efforts, protect spilled material from stormwater run-on during rainfall or trackout from motorists.
- Preserve existing vegetation by defining the work area and replacing the damaged vegetation outside the defined work area.
- Avoid stockpiling contaminated soils or hazardous material. If temporary stockpiling is unavoidable, do not stockpile in or near stormwater drainage system or watercourses.
- If working off-road, inspect and remove rock and sediment from tires prior to leaving the site to reduce the potential of tracking litter, debris and sediment onto public roadways.
- Coordinate removal of the solid, liquid and hazardous waste with the District Hazardous Materials Coordinator or Manager.

#### Applicable Maintenance BMPs in Appendix C

- Scheduling and Planning, C.3
- Storm Drain Inlet Protection, C.5
- Preservation of Existing Vegetation, C.8
- Stabilized Activity Entrance/Exit, C.12.1
- Tire Inspection and Sediment Removal, C.12.2
- Spill Prevention and Control, C.13.1
- Solid Waste Management, C.13.2
- Hazardous Waste Management, C.13.3
- Contaminated Soil Management, C.13.4
- Sanitary/Septic Waste Management, C.13.5
- Liquid Waste Management, C.13.6
- Material Use, C.14.2
- Vehicle and Equipment Operations, C.15
- Water Conservation Practice, C.18
- Safer Alternative Products, C.21
- Illegal Connection and Illicit Discharge (IC/ID), C.22.3
- Illegal Spill Discharge Control, C.22.4
- Sweeping and Vacuuming, C.29

## D FAMILY – LITTER/DEBRIS/GRAFFITI

### Graffiti Removal



#### Environmental Concerns

Discharge of the following materials into the stormwater drainage system or watercourse:

- Fuel
- Graffiti removal products
- Grit
- Non-stormwater
- Paint
- Sediment
- Vehicle fluids

*Graffiti removal operation; no spills*

#### DEFINITION AND PURPOSE

Graffiti is removed or painted over. The primary activities are the operation of support equipment, paint removal (may include hydroblasting, sandblasting, soda blasting or washing with graffiti removal products) and painting.

#### OPERATIONAL PROCEDURES

The following procedures are used where paint, grit and non-stormwater may pollute stormwater runoff or discharge to stormwater drainage system and watercourses.

- This activity shall not be performed during rain events or prior to predicted rain events.
- Secure paint while transporting to avoid spills.
- Refer to H Family activity when hydroblasting, sandblasting, soda blasting or washing.
- Protect drain inlets and watercourses from potential spills.
- Tarps and similar control measures shall be used to prevent spills or material drift from being deposited into stormwater drainage system or watercourses.
- Only headquarters pre-approved graffiti removal products shall be used.
- Mix paint indoors or in a containment area away from drain inlets.
- Water used for cleaning and decontamination shall not be allowed to enter stormwater drainage system or watercourses.
- Do not remove original product label from paint or hazardous materials containers as it contains important spill cleanup and disposal information. Use the entire product before disposing of the container. Appropriately label all secondary containers.
- Waste from cleaning paint equipment or brushes shall be collected and put into a bucket or drum with a secure lid for transport back to the maintenance facility to be reused, recycled or disposed

## D FAMILY – LITTER/DEBRIS/GRAFFITI

### Graffiti Removal

of properly. Paint waste, especially if it is oil based or contains paint thinner, would need approval from the publicly owned treatment works to dispose of in sewer.

- Solid waste shall be collected by vacuum or sweeping and secured in an appropriate container for transport back to the Maintenance facility to be reused, recycled or disposed of properly.

#### Applicable Maintenance BMPs in Appendix C

- Scheduling and Planning, C.3
- Storm Drain Inlet Protection, C.5
- Spill Prevention and Control, C.13.1
- Solid Waste Management, C.13.2
- Liquid Waste Management, C.13.6
- Material Use, C.14.2
- Vehicle and Equipment Operations, C.15
- Water Conservation Practice, C.18
- Safer Alternative Products, C.21
- Illegal Connection and Illicit Discharge (IC/ID), C.22.3
- Illegal Spill Discharge Control, C.22.4
- Sweeping and Vacuuming, C.29



# E Family – Landscaping

## Chemical Vegetation Control



### Environmental Concerns

Discharge of the following materials into the stormwater drainage system or watercourse:

- Fuel
- Non-stormwater
- Pesticides
- Sediment
- Vehicle fluids

*Clean and secured facility chemical storage units*

### DEFINITION AND PURPOSE

This method of vegetation control uses pesticides (e.g., herbicides, pre-emergents) to eliminate and prevent the growth of undesirable vegetation within the highway right-of-way. Chemical vegetation controls are used to protect preferred vegetation, to provide fire protection and to improve roadside appearance. The activity includes the operation of support equipment, mixing and loading chemicals and chemical application to irrigated vegetation.

### OPERATIONAL PROCEDURES

The following procedures are used to prevent releases of pesticides, sediment and equipment fluids to stormwater drainage system and watercourses.

Vegetation management can result in reduced erosion control effectiveness. BMP implementation will depend on traffic, weather, available resources and safety conditions.

- This activity shall not be performed if there is a 50% or greater likelihood that 0.10 inch or more of precipitation will fall within a 24-hour period, as predicted by NOAA at: <http://www.wrh.noaa.gov/forecast/wxtables/index.php?wfo=sto>.
- A licensed Agricultural Pest Control Adviser (PCA) should approve the activities.
- Identify drain inlets and watercourses, both upstream and downstream of the activity site. Protect the drain inlets, culverts, stormwater drainage system and watercourses from discharges of potential pollutants.
- Mixing and loading into spray equipment should be in a containment area away from drain inlets and watercourses.



## E FAMILY – LANDSCAPING

### Chemical Vegetation Control

#### OPERATIONAL PROCEDURES (CONT'D)

- Apply pesticides in compliance with federal, state and local pesticide use regulations as recommended by the District Annual Vegetation Control Plan. Apply pesticides only as specified on the "Pesticide Use Recommendation" on the label and as approved by the PCA.
- Calibrate the spray rig to ensure accurate application of pesticides.
- Minimize the use of pesticides in or near stormwater drainage system or watercourses.
- Water used for chemical mixing or in application must be controlled to prevent unauthorized non-stormwater discharges.
- Preserve existing vegetation by defining the work area and replacing the damaged vegetation outside the defined work area.
- Avoid using overhead irrigation for as long as the chemical manufacturer recommends after applying pesticides.

#### Applicable Maintenance BMPs in Appendix C

- Scheduling and Planning, C.3
- Storm Drain Inlet Protection, C.5
- Preservation of Existing Vegetation, C.8
- Spill Prevention and Control, C.13.1
- Material Use, C.14.2
- Vehicle and Equipment Operations, C.15
- Water Conservation Practice, C.18
- Safer Alternative Products, C.21
- Illegal Connection and Illicit Discharge (IC/ID), C.22.3
- Illegal Spill Discharge Control, C.22.4
- Chemical Vegetation Control, C.25

## E FAMILY – LANDSCAPING

### Manual Vegetation Control



#### Environmental Concerns

Discharge of the following materials into the stormwater drainage system or watercourse:

- Fuel
- Non-stormwater
- Sediment
- Vegetation debris
- Vehicle fluids

*Weed abatement operation*

#### DEFINITION AND PURPOSE

Manual vegetation control is the use of handheld equipment (some equipment may be gas-powered) to control grass and weeds within the highway right-of-way. Manual vegetation controls are used to protect existing vegetation, to maintain unobstructed views of the road edge and traffic safety devices, to provide fire protection, and to improve roadside appearance.

#### OPERATIONAL PROCEDURES

The following procedures are used to prevent releases of debris and equipment fluids to stormwater drainage system and watercourses.

Vegetation management can result in reduced erosion control effectiveness. BMP implementation will depend on traffic, weather, available resources and safety conditions.

- Protect drain inlets and watercourses from potential spills and vegetative debris.
- Do not fuel equipment near drain inlets or watercourses.
- Keep vegetation and clippings out of the stormwater drainage system and watercourses. Solid waste should be disposed of properly.
- Prevent sediment runoff from equipment rinsing shall not be discharged to the stormwater drainage system or watercourses. Rinse sediment in designated rinsing areas to prevent discharge to the stormwater drainage system.
- Preserve existing vegetation by defining the work area and replacing the damaged vegetation outside the defined work area.

## E FAMILY – LANDSCAPING

### Manual Vegetation Control

#### Applicable Maintenance BMPs in Appendix C

- Scheduling and Planning, C.3
- Storm Drain Inlet Protection, C.5
- Preservation of Existing Vegetation, C.8
- Spill Prevention and Control, C.13.1
- Solid Waste Management, C.13.2
- Sanitary/Septic Waste Management, C. 13.5
- Vehicle and Equipment Operations, C.15
- Illegal Connection and Illicit Discharge (IC/ID), C.22.3
- Illegal Spill Discharge Control, C.22.4

## E FAMILY – LANDSCAPING

### Landscaped Mechanical Vegetation Control/Mowing



Mowing

#### Environmental Concerns

Discharge of the following materials into the stormwater drainage system or watercourse:

- Fuel
- Non-stormwater.
- Sediment
- Vegetation debris
- Vehicle fluids

#### DEFINITION AND PURPOSE

Mechanical vegetation control includes removal of grasses and weeds within the highway right-of-way using machinery and mobile equipment. Mechanical vegetation controls are used to protect preferred vegetation, to maintain unobstructed views of the road edge and traffic safety devices, to provide fire protection and to improve roadside appearance.

#### OPERATIONAL PROCEDURES

The following procedures are used to prevent releases of clippings, sediment and equipment fluids to stormwater drainage system and watercourses.

Vegetation management can result in reduced erosion control effectiveness. BMP implementation will depend on traffic, weather, available resources and safety conditions.

Vegetation management can result in reduced erosion control effectiveness. BMP implementation will depend on traffic, weather, available resources and safety conditions.

- Protect drain inlets and watercourses from potential spills and vegetative debris.
- Do not fuel equipment near drain inlets or watercourses.
- Keep vegetation and clippings out of the stormwater drainage system and watercourses. Solid waste should be disposed of properly.



Mower equipment well maintained; no leaks/drips observed

## E FAMILY – LANDSCAPING

### Landscaped Mechanical Vegetation Control/Mowing

#### OPERATIONAL PROCEDURES (CONT'D)

- Prevent runoff. Sediment from equipment rinsing shall not be discharged to the stormwater drainage system or watercourses. Rinse sediment in designated rinsing areas to prevent discharge to the stormwater drainage system. Consider using backpack blowers to remove debris accumulation from vehicles and equipment.

Preserve existing vegetation by defining the work area and replacing the damaged vegetation outside the defined work area.

#### Applicable Maintenance BMPs in Appendix C

- Scheduling and Planning, C.3
- Preservation of Existing Vegetation, C.8
- Spill Prevention and Control, C.13.1
- Solid Waste Management, C.13.2
- Vehicle and Equipment Operations, C.15
- Illegal Connection and Illicit Discharge (IC/ID), C.22.3
- Illegal Spill Discharge Control, C.22.4

## E FAMILY – LANDSCAPING

### Landscaped Tree and Shrub Pruning, Brush Chipping, Tree and Shrub Removal



*Mulch used on level landscaping*

#### Environmental Concerns

Discharge of the following materials into the stormwater drainage system or watercourse:

- Fuel
- Non-stormwater
- Sawdust
- Sediment
- Vegetation debris
- Vehicle fluids
- Wood
- Wood mulch

#### DEFINITION AND PURPOSE

Trees and shrubs of planted landscape vegetation along the highway right-of-way are pruned to preserve their health, remove dead branches, protect utilities, maintain sight distances, preserve aesthetics and prevent property damage. The wood is chipped with mechanical chippers to facilitate the removal of tree and shrub limbs from the roadside. Chipped material can be used as mulch. Dead or diseased trees and shrubs may be removed to protect public safety.

#### OPERATIONAL PROCEDURES

Trees and shrubs of planted landscape vegetation along the highway right-of-way are pruned to preserve their health, remove dead branches, protect utilities, maintain sight distances, preserve aesthetics and prevent property damage. The wood is chipped with mechanical chippers to facilitate the removal of tree and shrub limbs from the roadside. Chipped material can be used as mulch. Dead or diseased trees and shrubs may be removed to protect public safety.

Vegetation management can result in reduced erosion control effectiveness. BMP implementation will depend on traffic, weather, available resources and safety conditions.



*Fuel can and absorbent pad on truck gate*



## E FAMILY – LANDSCAPING

### Landscaped Tree and Shrub Pruning, Brush Chipping, Tree and Shrub Removal

#### OPERATIONAL PROCEDURES (CONT'D)

- Protect drain inlets and watercourses from potential spills and vegetative debris.
- Do not fuel equipment near drain inlets or watercourses.
- Keep vegetation debris, clippings and mulch out of the stormwater drainage system and watercourses. Brush cuttings chipped into wood mulch should not be used at locations prone to washout.
- Preserve existing vegetation by defining the work area and replacing the damaged vegetation outside the defined work area.
- Prevent sediment runoff from equipment rinsing from discharging to the stormwater drainage system or watercourses.
- Do not stockpile prunings and clippings in or near stormwater drainage system or watercourses.
- Brush cuttings that are not chipped should be transported to the maintenance facility for proper disposal.

#### Applicable Maintenance BMPs in Appendix C

- Scheduling and Planning, C.3
- Storm Drain Inlet Protection, C.5
- Preservation of Existing Vegetation, C.8
- Spill Prevention and Control, C.13.1
- Solid Waste Management, C.13.2
- Sanitary/Septic Waste Management, C.13.5
- Vehicle and Equipment Operations, C.15
- Stockpile Management, C.17
- Illegal Connection and Illicit Discharge (IC/ID), C.22.3
- Illegal Spill Discharge Control, C.22.4

## E FAMILY – LANDSCAPING

### Irrigation Lines



*Work area clean and well maintained*

#### Environmental Concerns

Discharge of the following materials into the stormwater drainage system or watercourse:

- Debris
- Fuel
- Non-stormwater
- Primer
- PVC glue
- Sand
- Sediment
- Vehicle fluids

#### DEFINITION AND PURPOSE

Irrigation line repairs include maintenance (water line flushing) and repair activities on broken water lines, sprinklers and valves.<sup>2</sup>

#### OPERATIONAL PROCEDURES

The following procedures are used where debris and irrigation materials may pollute stormwater runoff or discharge to stormwater drainage system and watercourses.

- Tarp imported fill material transported in open-bed trucks to the work area. Do not overfill trucks.
- Shut off the water source to isolate a broken line, sprinkler or valve as soon as possible to minimize the loss of water.
- Protect downstream stormwater drainage system and watercourse from
- water pumped or bailed from trenches excavated to repair water lines.
- Protect drain inlets and watercourses from potential spills and debris.
- Do not fuel equipment near drain inlets or watercourses.
- When possible, water used to flush the line should be applied to the landscape.
- Manage irrigation systems to ensure the appropriate amount of water is used and runoff is minimized.

<sup>2</sup> Irrigation water and landscape irrigation are conditionally exempt discharges if appropriate control measures are developed and implemented under the SWMP.



## E FAMILY – LANDSCAPING

### Irrigation Lines

#### OPERATIONAL PROCEDURES (CONT'D)

- Preserve existing vegetation by defining the work area and replacing the damaged vegetation outside the defined work area.
- Stabilize the erodible ground surface that require protection as soon as possible after completing repairs. Compact soil or apply wood mulch if revegetation is not desired.
- Sweep or vacuum site and inspect and remove rock and sediment from tires prior to leaving the site to reduce the potential of tracking litter, debris and sediment from the site. Properly dispose of all solid waste.

#### Applicable Maintenance BMPs in Appendix C

- Scheduling and Planning, C.3
- Sediment Control, C.4
- Storm Drain Inlet Protection, C.5
- Compaction, C.7.1
- Hydroseeding/Handseeding, C.7.4
- Preservation of Existing Vegetation, C.8
- Spill Prevention and Control, C.13.1
- Solid Waste Management, C.13.2
- Material Use, C.14.2
- Vehicle and Equipment Operations, C.15
- Water Conservation Practice, C.18
- Potable Water/Irrigation, C.19
- Illegal Connection and Illicit Discharge (IC/ID), C.22.3
- Illegal Spill Discharge Control, C.22.4

## E FAMILY – LANDSCAPING

### Irrigation (Watering), Potable and Non-potable



#### Environmental Concerns

Discharge of the following materials into the stormwater drainage system or watercourse:

- Fuel
- Non-stormwater
- Sediment
- Vehicle fluids

*Automatic landscape irrigation; clean site*

#### DEFINITION AND PURPOSE

Irrigation or watering activities are performed using potable and nonpotable water.<sup>3</sup>

#### OPERATIONAL PROCEDURES

The following procedures are used where equipment fluids may pollute stormwater runoff or discharge to stormwater drainage system and watercourses.

- Frequently inspect and repair broken water lines.
- Protect drain inlets and watercourses from potential spills and debris.
- Do not fuel equipment near drain inlets or watercourses.
- When possible, water used to flush the line should be applied to the landscape.
- Avoid overwatering. Manage irrigation systems to ensure the appropriate amount of water is used and runoff is minimized.
- Minimize disturbance of existing vegetation.

<sup>3</sup> Irrigation water and landscape irrigation are conditionally exempt discharges if appropriate control measures are developed and implemented under the SWMP.

## E FAMILY – LANDSCAPING

### Irrigation (Watering), Potable and Non-potable

#### Applicable Maintenance BMPs in Appendix C

- Scheduling and Planning, C.3
- Vehicle and Equipment Operations, C.15
- Water Conservation Practice, C.18
- Potable Water/Irrigation, C.19
- Illegal Connection and Illicit Discharge (IC/ID), C.22.3
- Illegal Spill Discharge Control, C.22.4

# F Family – Stormwater

## Storm Drain Stenciling



*Storm drain stenciling*

### Environmental Concerns

Discharge of the following materials into the stormwater drainage system or watercourse:

- Fuel
- Non-stormwater
- Paint
- Sediment
- Trash
- Vehicle fluids

### DEFINITION AND PURPOSE

Stencils are applied to facility and roadway storm drain inlets in areas with pedestrian use for communities with over 10,000 residents or within designated MS4s. Stenciling is not required in areas where pedestrians are prohibited.

### OPERATIONAL PROCEDURES

The following procedures are used where storm drain stenciling may pollute stormwater runoff or discharge to stormwater drainage system and watercourses.

- Protect drains, watercourses and manholes from potential spills and stenciling products.
- Non-stormwater discharges to drainage paths, drainage systems and watercourses are prohibited.
- Verify that spill control cleanup materials are located in the unloading and use areas.
- Avoid sweeping sediment into drain inlets.



*Facility storm drain stenciling downgradient of hazardous waste storage lockers*

## F FAMILY – STORMWATER

### Storm Drain Stenciling

#### OPERATIONAL PROCEDURES (CONT'D)

- The use of safer alternative products may still be harmful if discharged to drainage paths, stormwater drainage system or watercourses. Use safer alternative products in accordance with manufacturer recommendations.
- Mixing of paint and loading of equipment should be away from drain inlets.
- Solid waste should be collected by vacuum or sweeping and secured in an appropriate container for transport to the Maintenance facility to be reused, recycled or disposed of properly.

#### Applicable Maintenance BMPs in Appendix C

- Scheduling and Planning, C.3
- Storm Drain Inlet Protection, C.5
- Spill Prevention and Control, C.13.1
- Solid Waste Management, C.13.2
- Liquid Waste Management, C.13.6
- Material Use, C.14.2
- Vehicle and Equipment Operations, C.15
- Storm Drain Stenciling, C.20
- Safer Alternative Products, C.21
- Illegal Connection and Illicit Discharge (IC/ID), C.22.3
- Illegal Spill Discharge Control, C.22.4

## F FAMILY – STORMWATER

### Roadside Slope Inspection



*Shoulder graded; slope with netting and hydroseeding*

#### Environmental Concerns

Discharge of the following materials into the stormwater drainage system or watercourse:

- Fuel
- Non-stormwater
- Sediment
- Vehicle fluids

#### DEFINITION AND PURPOSE

Slopes prone to erosion and sediment discharge are periodically inspected to determine the need for erosion control measures.

#### OPERATIONAL PROCEDURES

The following procedures are used to identify potential pollutant sources to stormwater runoff or discharge to stormwater drainage systems and watercourses during roadside slope inspection.

- Inspect slopes for erosion on a five-year cycle. Slopes with recurring problems should be inspected as necessary.
- District Maintenance staff will conduct initial inspections of roadside slopes prone to erosion and sediment discharge. An evaluation report should be prepared for each slope inspected as necessary.
- Identify if the designated area contains Biofiltration Strip and Swales needing repair.
- Minor erosion repairs and stabilization, as determined by existing Maintenance policy, may be completed by District Maintenance crews.
- When complex slopes prone to erosion and sediment discharge problems are identified, District Maintenance staff will consider solutions and may recommend the needed corrective action as a future project for the State Highway Operation and Protection Program (SHOPP).
- Record the inspection findings and repairs in IMMS

#### Applicable Maintenance BMPs in Appendix C

- Vehicle and Equipment Operations, C.15
- Illegal Connection and Illicit Discharge (IC/ID), C.22.3
- Illegal Spill Discharge Control, C.22.4
- Slopes Prone to Erosion and Sediment Discharge, C.26



## F FAMILY – STORMWATER

### Roadside Stabilization



*Shoulder needs stabilization after heavy winter rains*

#### Environmental Concerns

Discharge of the following materials into the stormwater drainage system or watercourse:

- Binders
- Fertilizer
- Fiber
- Fuel
- Non-stormwater
- Sediment
- Seed
- Vehicle fluids

#### DEFINITION AND PURPOSE

Roadside stabilization refers to the erosion control and/or soil stabilization practices on slopes within the highway right-of-way.

#### OPERATIONAL PROCEDURES

The following procedures are used where roadside stabilization material may pollute stormwater runoff or discharge to stormwater drainage system and watercourses.

- Inspect roadside slopes for erosion on a five-year cycle. Areas with recurring problems should be inspected on an as-needed basis.
- Tarp imported fill material and other roadside stabilization materials with drift potential when transporting them to the work area in open bed trucks. Do not overfill trucks.
- Protect drain inlets and watercourses from potential spills including roadside stabilization materials.
- Stabilize the entrance/exits to the work area, if necessary, to avoid tracking mud or sediments on to public roadways.
- Do not stockpile sediment or material in or near stormwater drainage system or watercourses. Protect stockpiles with a cover or sediment barrier during rainstorms.
- Check dams are used in the work area receiving concentrated flow. Sediment buildup should be removed before reaching 1/3 the height of check dam. Remove the check dams when the maintenance activity is completed.
- Install sediment barriers around the toe of the slope, downslope and around the slope and stockpiles to allow sediment to settle before any runoff leaves the work area. Sediment can be controlled with silt fences, sandbags or gravel bags, straw bales and fiber rolls.

## F FAMILY – STORMWATER

### Roadside Stabilization

#### OPERATIONAL PROCEDURES (CONT'D)

- Hydromulch, hydroseed/handseed or straw mulch the erodible ground surface requiring protection as soon as possible after completing stabilization work. Contact the District Landscape Specialist, District Erosion Control Specialist or Landscape Architect for the appropriate application rates.
- Silt fences should be constructed with a setback of at least 1 meter beyond the toe of a slope, if possible. Remove sediment prior to accumulation reaching one-third of the fence height. Incorporate removed sediment into the maintenance activity site if possible. Remove the silt fence when it is no longer needed.
- Fiber rolls are not used for high water flows. Fiber rolls that are used to reduce slope length should be placed in a shallow trench on a level contour and staked securely. Fiber rolls may be left at the site to biodegrade.
- Inspect and repair silt fence, sandbags, gravel bags, straw bale barriers or fiber rolls to ensure the sediment barrier(s) is functioning properly.
- Preserve existing vegetation by defining the work area and replacing the damaged vegetation outside the defined work area.
- Control dust and erosion in windy or wind-prone areas using covers, water or soil stabilizers.
- Use appropriate amount of water so that runoff and erosion is minimized.
- Compact soil if revegetation is not desired. Consider applying wood mulch. Contact the District Landscape Specialist, District Erosion Control Specialist or Landscape Architect for the appropriate application rate.
- Sweep or vacuum excess over spray of binders, fertilizers fiber and seed on hardscape. Incorporate the materials into the maintenance activity area.
- Sweep or vacuum site and inspect and remove rock and sediment from tires prior to leaving the site to reduce the potential of tracking litter, debris, and sediment from the site. Recycle or dispose of material properly.



## F FAMILY – STORMWATER

### Roadside Stabilization

#### Applicable Maintenance BMPs in Appendix C

- Scheduling and Planning, C.3
- Sediment Control, C.4
- Storm Drain Inlet Protection, C.5
- Compaction, C.7.1
- Hydraulic Mulch, C.7.3
- Hydroseeding/Handseeding, C.7.4
- Soil Binders, C.7.5
- Preservation of Existing Vegetation, C.8
- Wind Erosion Control, C.11
- Stabilized Activity Entrance/Exit, C.12.1
- Tire Inspection and Sediment Removal, C.12.2
- Spill Prevention and Control, C.13.1
- Sanitary/Septic Waste Management, C.13.5
- Material Use, C.14.2
- Vehicle and Equipment Operations, C.15
- Stockpile Management, C.17
- Water Conservation Practice, C.18
- Safer Alternative Products, C.21
- Illegal Connection and Illicit Discharge (IC/ID), C.22.3
- Illegal Spill Discharge Control, C.22.4
- Slopes Prone to Erosion and Sediment Discharge, C.26
- Sweeping and Vacuuming, C.29

## F FAMILY – STORMWATER

### Stormwater Treatment Devices



*Biofiltration swale*

#### Environmental Concerns

Discharge of the following materials into the stormwater drainage system or watercourse:

- Fuel
- Non-stormwater
- Oil
- Sediment
- Trash
- Vehicle fluids

#### DEFINITION AND PURPOSE

Stormwater treatment devices are measures or structures installed primarily to reduce stormwater pollutants and improve water quality.

#### OPERATIONAL PROCEDURES

Stormwater treatment devices are planned, designed and installed through the Caltrans new construction, major reconstruction and retrofit project delivery process where a storm drain system discharges directly or indirectly to surface water

- Limit the entrance/exit points to the activity site and stabilize against erosion.
- Avoid stockpiling contaminated soil or sediment and dispose of properly.
- If clean sediment cannot be recycled, transport the material back to the Maintenance facility or an approved storage site.
- Remove gravel and sediment from tires before reentering the highway.
- These are approved TBMPs in Appendix C.23 that shall be inspected and maintained at least annually:
  - Biofiltration Strips and Swales
  - Infiltration Basins
  - Infiltration Trenches
  - Detention Devices
  - Traction Sand Traps
  - Gross Solids Removal Devices
  - Bioretention Basins



*GSRD- Linear Radial Device*

## F FAMILY – STORMWATER

### Stormwater Treatment Devices

#### OPERATIONAL PROCEDURES (CONT'D)

- Austin Sand Filters
- Delaware Sand Filters
- Multi-Chambered Treatment Trains
- Wet Basins
- There are non-approved TBMPs (Appendix C.23) that were part of pilot studies. Unless decommissioned, the following should be maintained as necessary:
  - Oil/Water Separator
  - Drain Inlet Insert (DII), Fossil Filter or StreamGuard
  - Storm Filter™
  - Continuous Deflection Separation Unit
  - If proprietary treatment devices are installed, the manufacturer's maintenance recommendation will be followed.

#### Applicable Maintenance BMPs in Appendix C

- Scheduling and Planning, C.3
- Stabilized Activity Entrance/Exit, C.12.1
- Tire Inspection and Sediment Removal, C.12.2
- Solid Waste Management, C.13.2
- Contaminated Soil Management, C.13.4
- Vehicle and Equipment Operations, C.15
- Illegal Connection and Illicit Discharge (IC/ID), C.22.3
- Illegal Spill Discharge Control, C.22.4
- Biofiltration Strips and Swales, C.23.1
- Infiltration Basins, C.23.2
- Infiltration Trenches, C.23.3
- Detention Devices, C.23.4
- Traction Sand Trap C.23.5
- Gross Solids Removal Devices, C.23.6
- Austin Sand Filters, C.23.7
- Delaware Sand Filters, C.23.8
- Multi-Chambered Treatment Trains, C.23.9
- Wet Basins, C.23.10
- Bioretention, C.23.12
- Litter and Debris, C.24.1

# G Family – Service Facilities

## Public Facilities



*Good housekeeping at a Safety Roadside Rest Area (SRRA)*

### Environmental Concerns

Discharge of the following materials into the stormwater drainage system or watercourse:

- Fuel
- Litter
- Non-stormwater
- Paint
- Pesticides
- Sand blast grit
- Sediment
- Vehicle fluids

### DEFINITION AND PURPOSE

Public facilities include safety roadside rest areas, commercial vehicle enforcement facilities, park-and-ride lots and vista points. The degree of maintenance includes a range of custodial responsibilities that may include restrooms, fountains, picnic areas, and other public facilities. Maintenance of appurtenances such as roadway surfacing, signs, pavement markings, buildings, landscaping and electrical installations are also considered under this category.

### OPERATIONAL PROCEDURES

The following procedures are used where maintenance of public facilities may pollute stormwater runoff or discharge to stormwater drainage system and watercourses.

- Secure or cover transported materials, equipment and supplies to and from public facilities to prevent spillage to the roadway.
- Keep the storage areas clean, well organized, and stocked with spill cleanup supplies.
- Inspect and replace unreadable anti-litter signs and storm drain stenciling at public facilities.
- Protect drain inlets and watercourses from potential spills.
- Do not fuel equipment near drain inlets or watercourses.
- Preserve existing vegetation by defining the work area and replace the damaged vegetation outside the defined work area.
- Avoid overwatering. Ensure irrigation controllers are programmed to minimize runoff
- When using chemicals for cleaning, consider safer alternative products where practical and effective.

## G FAMILY – SERVICE FACILITIES

### Stormwater Treatment Devices

#### OPERATIONAL PROCEDURES (CONT'D)

- Used spill cleanup materials, contaminated materials and recovered spill material that are not reusable shall be disposed of properly. Do not pick up any unknown items or materials that may be potentially hazardous. Notify the facility Supervisor.
- Liquid waste and concrete washout should be collected in a container with a secure lid and transported back to the Maintenance facility for proper disposal. Concrete contractors are required to comply with Caltrans Standard Specification Section 13-9 Temporary Concrete Washouts.
- Solid waste should be stored away from stormwater drainage system and watercourses.
- Solid waste should be collected by vacuum or sweeping and secured in an appropriate container for transport back to the Maintenance facility to be reused, recycled or disposed of properly. Inspect for septic waste discharge or IC/ID and report any findings to your supervisor.

#### Applicable Maintenance BMPs in Appendix C

- Scheduling and Planning, C.3
- Storm Drain Inlet Protection, C.5
- Preservation of Existing Vegetation, C.8
- Spill Prevention and Control, C.13.1
- Solid Waste Management, C.13.2
- Sanitary/Septic Waste Management, C.13.5
- Liquid Waste Management, C.13.6
- Concrete Waste Management, C.13.7
- Material Delivery and Storage, C.14.1
- Material Use, C.14.2
- Vehicle and Equipment Operations, C.15
- Water Conservation Practice, C.18
- Potable Water/Irrigation, C.19
- Storm Drain Stenciling, C.20
- Safer Alternative Products, C.21
- Illegal Connection and Illicit Discharge (IC/ID), C.22.3
- Illegal Spill Discharge Control, C.22.4
- Litter and Debris, C.24.1
- Anti-Litter Signs, C.24.2
- Sweeping and Vacuuming, C.29
- Maintenance Facility Housekeeping Practices, C.30

# H Family – Bridges

## Welding and Grinding

### Environmental Concerns

Discharge of the following materials into the stormwater drainage system or watercourse:

- Debris
- Fuel
- Grit
- Lead contaminated materials
- Metal grindings
- Non-stormwater
- Paint
- Sediment
- Solder
- Vehicle fluids

### DEFINITION AND PURPOSE

Welding and grinding is performed on bridges to repair damaged or deteriorating components, but has been expanded to also include roads and individual service facilities

### OPERATIONAL PROCEDURES

The following procedures are used where welding and grinding work may pollute stormwater runoff or discharge to stormwater drainage system and watercourses.

The BMPs for this activity provide operating methods or measures only for stormwater pollution prevention. The applicable local, state and federal hazardous materials, employee safety and fire prevention requirements are not presented.

Although not a BMP, it is important that only properly trained employees with the appropriate personal protection equipment shall conduct work on bridges containing lead-based paint.

- Secure all equipment and tools. Prevent foreign objects from being dropped into the watercourse or bay.
- Use appropriate containment when welding over the side of a bridge to capture slag and metal grindings.
- For welding work over a storm drain inlet, protect the drain inlet to prevent grindings and debris from entering the stormwater drainage system or watercourses.
- For welding work on the deck services or expansion plates, use maintenance traveler or wing staging to capture grindings and debris.
- Remove all slag and debris from the deck or other work sites when the job is completed.
- Use an appropriate container to collect slag, excess materials and solid waste and transport to the Maintenance facility for reuse, recycling or proper disposal.

## H FAMILY – BRIDGES

### Welding and Grinding

#### Applicable Maintenance BMPs in Appendix C

- Scheduling and Planning, C.3
- Storm Drain Inlet Protection, C.5
- Solid Waste Management, C.13.2
- Hazardous Waste Management, C.13.3
- Material Use, C.14.2
- Vehicle and Equipment Operations, C.15
- Safer Alternative Products, C.21
- Illegal Connection and Illicit Discharge (IC/ID), C.22.3
- Illegal Spill Discharge Control, C.22.4



## H FAMILY – BRIDGES

### Sandblasting, Wet Blast with Sand Injection and Hydroblasting



Crew sandblasting

#### Environmental Concerns

Discharge of the following materials into the stormwater drainage system or watercourse:

- Fuel
- Grit
- Lead contaminated materials
- Non-stormwater
- Paint
- Sediment
- Vehicle fluids

#### DEFINITION AND PURPOSE

This activity involves the removal of graffiti and is used to clean concrete walls and structural steel. Subtasks include the operation of support vehicles and equipment and the blasting operations.

#### OPERATIONAL PROCEDURES

The following procedures are used where blasting grit and paint may pollute stormwater runoff or discharge to stormwater drainage system and watercourses.

The BMPs presented for this activity provide operating methods or measures only for the purpose of stormwater pollution prevention. The applicable local, state and federal hazardous materials, employee safety and fire prevention requirements are not presented.

Although not a BMP, it is important that only properly trained employees with the appropriate personal protection equipment shall conduct work on bridges containing lead-based paint.

- Secure all equipment and tools. Prevent foreign objects from being dropped into the watercourses or bay.
- Protect drain inlets and watercourses from potential spills and debris.
- If chemicals are used for cleaning, consider safer alternative products where practical and effective.



Sandblasting to etch median barrier

## H FAMILY – BRIDGES

### Sandblasting, Wet Blast with Sand Injection and Hydroblasting

#### OPERATIONAL PROCEDURES (CONT'D)

- Evaluate the possibility of using a hydro blaster to complete work. When performing hydroblasting using a permanent traveler, use control measures to prevent solid and liquid spills or materials from entering the watercourses.
- Use minimum amount of sand necessary when sandblasting.
- Avoid excess use of water to minimize runoff.
- Use approved removal and disposal procedures when sand blasting to remove lead-based paint.
- Liquid waste should be collected in a container with a secure lid and transported to the Maintenance facility for proper disposal.
- Solid waste should be collected by vacuum or sweeping and secured in an appropriate container for transport to the Maintenance facility to be reused, recycled or disposed of properly.

#### Applicable Maintenance BMPs in Appendix C

- Scheduling and Planning, C.3
- Sediment Control, C.4
- Storm Drain Inlet Protection, C.5
- Spill Prevention and Control, C.13.1
- Solid Waste Management, C.13.2
- Hazardous Waste Management, C.13.3
- Sanitary/Septic Waste Management, C.13.5
- Liquid Waste Management, C.13.6
- Material Use, C.14.2
- Vehicle and Equipment Operations, C.15
- Water Conservation Practice, C.18
- Safer Alternative Products, C.21
- Illegal Connection and Illicit Discharge (IC/ID), C.22.3
- Illegal Spill Discharge Control, C.22.4
- Sweeping and Vacuuming, C.29

## H FAMILY – BRIDGES

### Painting



*Paint storage area labeled and organized*

#### Environmental Concerns

Discharge of the following materials into the stormwater drainage system or watercourse:

- Fuel
- Non-stormwater
- Paint
- Vehicle fluids

#### DEFINITION AND PURPOSE

Painting operations apply to the painting of bridge surfaces, but have also been expanded to include painting of facilities and highway structures. Routine maintenance of painting equipment is also included in this activity.

#### OPERATIONAL PROCEDURES

The following procedures are used where paint may pollute stormwater runoff or discharge to stormwater drainage system and watercourses.

- This activity shall not be performed during rain events or prior to predicted rain events, unless required by emergency conditions.
- Make sure paint containers are secure during transport to prevent spillage to the roadway.
- Mix paint indoor away from drain inlets or in a containment area. Load the paint spray equipment at the Maintenance facility.
- Protect drain inlets and watercourses from potential spills including painting products.
- Monitor weather and wind when using spray equipment.
- Use tarps or canvas under work area to capture excess paint or paint chips. Tarps and other control measures should be used to prevent spills or material drift to watercourse (e.g., during bridge maintenance). Transfer material captured into a waste container for proper disposal at a Maintenance facility.
- Do not remove original product label from paint or other hazardous materials containers as it contains important spill cleanup and disposal information. Use the entire product before disposing of the container. Appropriately label all secondary containers.
- Collect all paint equipment wash water and return it to a Maintenance facility for proper disposal.

## H FAMILY – BRIDGES

### Painting

#### Applicable Maintenance BMPs in Appendix C

- Scheduling and Planning, C.3
- Storm Drain Inlet Protection, C.5
- Spill Prevention and Control, C.13.1
- Solid Waste Management, C.13.2
- Hazardous Waste Management, C.13.3
- Liquid Waste Management, C.13.6
- Sanitary/Septic Waste Management, C.13.5
- Material Use, C.14.2
- Vehicle and Equipment Operations, C.15
- Safer Alternative Products, C.21
- Illegal Connection and Illicit Discharge (IC/ID), C.22.3
- Illegal Spill Discharge Control, C.22.4

## H FAMILY – BRIDGES

### Bridge Repairs



*Bridge work area over water lined with plastic sheeting*

#### Environmental Concerns

Discharge of the following materials into the stormwater drainage system or watercourse:

- Concrete
- Debris
- Fuel
- Non-stormwater
- Tools, equipment or parts
- Unused material
- Vehicle fluids

#### DEFINITION AND PURPOSE

Bridge maintenance activities include repairing bent or damaged steel beams, cracked or spalled concrete, damaged expansion joints and bent or damaged railings.

#### OPERATIONAL PROCEDURES

The following procedures are used where materials released from the bridge repairs may pollute stormwater runoff or discharge to stormwater drainage system and watercourses.

- When working over watercourses, stage the operation to capture and collect all debris, leaks and spills.
- Vehicle and equipment washing is allowed only at designated rinsing areas, wash racks or other designated areas. All engine compartment and undercarriage rinsing/washing must be performed within a wash rack facility. The Maintenance Stormwater Coordinator will approve or provide input on the approved location for a designated rinsing area.
- Liquid waste should be collected in a container with a secure lid and transported to the Maintenance facility for proper disposal.



*Work area over water; plastic sheet containment*

## H FAMILY – BRIDGES

### Bridge Repairs

#### OPERATIONAL PROCEDURES (CONT'D)

- Collect broken or damaged treated bridge pier fender posts. Solid waste should be collected by vacuum or sweeping and put into bags or buckets and secured for transport to the Maintenance facility to be reused, recycled or disposed of properly.
- See Activity Cut-Sheet Structural Pavement Failure (Digouts) Pavement Grinding and Paving.
- See Activity Cut-Sheet Concrete Slab and Spall Repair.
- See Activity Cut-Sheet Welding and Grinding, if applicable.

#### Applicable Maintenance BMPs in Appendix C

- Scheduling and Planning, C.3
- Spill Prevention and Control, C.13.1
- Sanitary/Septic Waste Management, C.13.5
- Vehicle and Equipment Operations, C.15
- Illegal Spill Discharge Control, C.22.4
- See A Family - Structural Pavement Failure (Digouts) Grinding and Paving
- See B Family - Concrete Slab and Spall Repair
- See H Family - Welding and Grinding



## H FAMILY – BRIDGES

### Draw Bridge Maintenance



*Sacramento Tower Bridge maintenance*

#### Environmental Concerns

Discharge of the following materials into the stormwater drainage system or watercourse:

- Fuel
- Non-stormwater
- Vehicle fluids

#### DEFINITION AND PURPOSE

Drawbridge maintenance activities include maintaining mechanical and electrical equipment, removing debris, drift and other pollutants from bridge sumps, pavement, or structure.

#### OPERATIONAL PROCEDURES

The following procedures are used where bridge maintenance may pollute stormwater runoff or discharge to stormwater drainage system and watercourses.

- Secure all equipment and tools. Prevent foreign objects from being dropped into the watercourses.
- When working over watercourses, stage the operation to capture and collect all debris, leaks or spills as possible.
- Tarps and similar control measures should be used to prevent spills or capture material drift into watercourses.
- Use drip pans under equipment with grease fittings to capture excess grease. Dispose of waste properly.
- Do not remove original product label from paint or hazardous materials containers as it contains important spill cleanup and disposal information. Use the entire product before disposing of the container. Appropriately label all secondary containers.
- Clean-up excess grease after greasing fittings by wiping down equipment, fittings and metal surfaces. Use the minimum amount of materials necessary to complete the job.
- Clean area by sweeping or vacuuming. Do not hose down.
- Liquid waste should be collected in a container with a secure lid and transported to the Maintenance facility for proper disposal.
- Solid waste should be collected by vacuum or sweeping and secured in an appropriate container for transport to the Maintenance facility to be reused, recycled or disposed of properly.



## H FAMILY – BRIDGES

### Draw Bridge Maintenance

#### Applicable Maintenance BMPs in Appendix C

- Scheduling and Planning, C.3
- Spill Prevention and Control, C.13.1
- Solid Waste Management, C.13.2
- Hazardous Waste Management, C.13.3
- Sanitary/Septic Waste Management, C.13.5
- Liquid Waste Management, C.13.6
- Material Use, C.14.2
- Vehicle and Equipment Operations, C.15
- Safer Alternative Products, C.21
- Illegal Spill Discharge Control, C.22.4

# J Family – Other Structures

## Pump Station Cleaning



Pumphouse cleaning

### Environmental Concerns

Discharge of the following materials into the stormwater drainage system or watercourse:

- Fuel
- Litter and debris
- Non-stormwater
- Sediment
- Vehicle fluids

### DEFINITION AND PURPOSE

Pump stations are used to dewater depressed highway sections where water routinely collects. Maintenance work includes structural repairs, removal of material from sumps, and periodic servicing or repairs of electrical and mechanical equipment.

### OPERATIONAL PROCEDURES

Periodic pump station inspection and cleaning will reduce the discharge of potential pollutants to the stormwater drainage system or watercourses.

The BMPs for this activity only provide operating methods or measures for the purpose of stormwater pollution prevention. The applicable local, state and federal hazardous materials and employee safety requirements are not presented.

Although not a BMP, it is important that work in confined space shall be conducted only by properly trained employees who use appropriate personal protection equipment.

- Protect drains and watercourses from potential spills.
- Stabilize the entrance/exits to the work area with soil stabilizers as necessary.



*Drip pad under fuel can and tools used at pump house*

## J FAMILY – OTHER STRUCTURES

### Pump Station Cleaning

#### OPERATIONAL PROCEDURES (CONT'D)

- Inspect pump stations routinely, per District policy, during the rainy season and off-season. Inspect screen to ensure it is free of debris. Remove solids in the sumps routinely to prevent damage to pumps. Inspect and clean pump outfall facilities, when possible, to ensure a free flow of water beyond the pumping station.
- Remove all waste oil and put into buckets or drums with a secure lid for transport back to the maintenance facility to be reused, recycled or disposed of properly.
- Avoid use of excess water during cleaning to minimize waste and Runoff
- Contaminated water used for cleaning and decontamination shall not be allowed to enter stormwater drainage system or watercourses.
- Dispose of liquid waste collected in the Vactor® trucks in an approved method.
- The facility Supervisor and District Maintenance Stormwater Coordinator or Manager will provide written instruction for preapproved decanting sites for liquid waste and the proper disposal site for contaminated soil.
- Sweep or vacuum site and inspect and remove rock and sediment from tires prior to leaving the site to reduce the potential of tracking litter, debris, and sediment from the site. Recycle or dispose of material properly.
- Do not stockpile sediment in or near stormwater drainage system or watercourses. Protect stockpiles with a cover or sediment barrier during rainstorms.

#### Applicable Maintenance BMPs in Appendix C

- Scheduling and Planning, C.3
- Stabilized Activity Entrance/Exit, C.12.1
- Tire Inspections and Sediment Removal, C.12.2
- Spill Prevention and Control, C.13.1
- Solid Waste Management, C.13.2
- Contaminated Soil Management, C.13.4
- Liquid Waste Management, C.13.6
- Vehicle and Equipment Operations, C.15
- Stockpile Management, C.17
- Water Conservation Practice, C.18
- Illegal Connection and Illicit Discharge (IC/ID), C.22.3
- Illegal Spill Discharge Control, C.22.4
- Sweeping and Vacuuming, C.29
- Maintenance Facility Housekeeping Practices, C.30

## J FAMILY – OTHER STRUCTURES

### Tube and Tunnel Maintenance and Repair



Washing tunnel wall

#### Environmental Concerns

Discharge of the following materials into the stormwater drainage system or watercourse:

- Cement
- Cleaning agents
- Fuel
- Grout
- Litter and debris
- Non-stormwater
- Paint
- Sediment
- Vehicle fluids

#### DEFINITION AND PURPOSE

Maintenance of tunnels and tubes involves removing dirt and debris from the tunnel and repairing the pavement and walls.

#### OPERATIONAL PROCEDURES

Tunnel and tube washing and maintenance reduces the accumulation of dirt, debris, and potential pollutants in these passageways, preserves capital investment and improves aesthetics.

- Sweep tunnel prior to conducting wash operations and properly dispose of swept material.
- Protect storm drain inlets prior to using cleaning agents and paints.
- Mix paint indoors or in a containment area. Do not clean paint brushes or rinse paint containers into drains or watercourses.
- Prevent cement, grout, concrete waste and non-stormwater discharges from entering drains and watercourses. Concrete contractors are required to comply with Caltrans Standard Specification Section 13-9 Temporary Concrete Washouts.
- If chemicals are used for cleaning, consider safer alternative products where practical and effective.
- Do not remove original product label from paint or hazardous materials containers as it contains important spill cleanup and disposal information. Use the entire product before disposing of the container. Appropriately label all secondary containers.
- Avoid excess use of water to minimize waste and runoff

## J FAMILY – OTHER STRUCTURES

### Tube and Tunnel Maintenance and Repair

#### OPERATIONAL PROCEDURES (CONT'D)

- Properly dispose of wastewater and debris. If acceptable to local sewer agency, dispose of wash water to the sanitary sewer system or the liquid waste should be collected and transported to the Maintenance facility for proper disposal.
- Solid waste should be collected by vacuum or sweeping and secured in an appropriate container for transport to the Maintenance facility to be reused, recycled or disposed of properly.

#### Applicable Maintenance BMPs in Appendix C

- Scheduling and Planning, C.3
- Storm Drain Inlet Protection, C.5
- Spill Prevention and Control, C.13.1
- Solid Waste Management, C.13.2
- Liquid Waste Management, C.13.6
- Concrete Waste Management, C.13.7
- Material Use, C.14.2
- Vehicle and Equipment Operations, C.15
- Water Conservation Practice, C.18
- Safer Alternative Products, C.21
- Illegal Connection and Illicit Discharge (IC/ID), C.22.3
- Illegal Spill Discharge Control, C.22.4
- See A Family - Structural Pavement Failure (Digouts) Pavement Grinding and Paving
- See B Family - Concrete Slab and Spall Repair

## J FAMILY – OTHER STRUCTURES

### Ferryboat Operations



*Good housekeeping on the ferryboat*

#### Environmental Concerns

Discharge of the following materials into the stormwater drainage system or watercourse:

- Fuel
- Litter
- Non-stormwater
- Toxic materials
- Vehicle fluids

#### DEFINITION AND PURPOSE

Ferryboats conveying vehicles and the public are maintained jointly by Maintenance and the Equipment Service Center.

#### OPERATIONAL PROCEDURES

The following procedures are used where ferry operations may pollute stormwater runoff or discharge to stormwater drainage system and watercourses.

- Perform a thorough pre-operational check to observe any equipment that could fail during ferry operation.
- Contain any leaks onboard by closing cofferdam drains and securing fuel and oil emergency shutoff valves.
- Carry spill cleanup material. Clean spills immediately and dispose of waste properly.
- Check refueling equipment and hoses before use. Monitor refueling operation closely and cease operation immediately if a leak develops.
- Do not discharge wash water or waste water to the water channel.
- Notify U.S. Coast Guard of any spills in the watercourses.

## J FAMILY – OTHER STRUCTURES

### Ferryboat Operations

#### Applicable Maintenance BMPs in Appendix C

- Scheduling and Planning, C.3
- Solid Waste Management, C.13.2
- Liquid Waste Management, C.13.6
- Vehicle and Equipment Operations, C.15
- Water Conservation Practice, C.18
- Safer Alternative Products, C.21
- Illegal Connection and Illicit Discharge (IC/ID), C.22.3
- Illegal Spill Discharge Control, C.22.4



## J FAMILY – OTHER STRUCTURES

### Tow Truck Operations



Caltrans tow truck

#### Environmental Concerns

Discharge of the following materials into the stormwater drainage system or watercourse:

- Fuel
- Glass
- Metal fragments
- Non-stormwater
- Plastics
- Rubber
- Sediment
- Vehicle fluids

#### DEFINITION AND PURPOSE

Tow truck operations involve the removal of vehicles from Caltrans' rights-of-way.

#### OPERATIONAL PROCEDURES

Potential pollution is possible from spills of vehicle parts and fluids from vehicle accidents and servicing of vehicles.

- Protect drain inlets and watercourses when necessary to prevent contaminants from entering drainage inlets.
- Clean up fluids or parts that are spilled onto the roadway from an accident site before leaving the scene.
- Use absorbent pads to soak up vehicle fluids, then sweep the area thoroughly to remove all loose debris and eliminate material and residue from entering drainage inlets.
- Liquid waste should be collected in a container with a secure lid and transported to the Maintenance facility for proper disposal.
- Solid waste should be collected by vacuum or sweeping and secured in an appropriate container for transport to the Maintenance facility to be reused, recycled or disposed of properly.
- Also, see Activity Cut-Sheet, D Family - Emergency Response and Cleanup Practices.

## J FAMILY – OTHER STRUCTURES

### Tow Truck Operations

#### Applicable Maintenance BMPs in Appendix C

- Spill Prevention and Control, C.13.1
- Solid Waste Management, C.13.2
- Hazardous Waste Management, C.13.3
- Liquid Waste Management, C.13.6
- Vehicle and Equipment Maintenance, C.15.3
- Safer Alternative Products, C.21
- Illegal Spill Discharge Control, C.22.4
- Maintenance Facility Housekeeping Practices, C.30

## J FAMILY – OTHER STRUCTURES

### Toll Booth Lane Scrubbing Operations



Clean toll booth lanes

#### Environmental Concerns

Discharge of the following materials into the stormwater drainage system or watercourse:

- Cleaning agents
- Non-stormwater
- Process water
- Sediment

#### DEFINITION AND PURPOSE

Lane scrubbing operations reduce the accumulation of dirt and oily buildup from vehicles. Lane scrubbing is implemented only near toll plazas.

#### OPERATIONAL PROCEDURES

The following procedures are used where lane scrubbing may pollute stormwater runoff or discharge to stormwater drainage system and watercourses.

- Use lane scrubbers with vacuum capability to remove wastewater from pavement during lane scrubbing operations.
- If chemicals are used for cleaning, consider safer alternatives where practical and effective.
- Liquid waste collected in the scrubber should be transported to the Maintenance facility or decanting area for proper disposal.

## J FAMILY – OTHER STRUCTURES

### Toll Booth Lane Scrubbing Operations

#### Applicable Maintenance BMPs in Appendix C

- Scheduling and Planning, C.3
- Solid Waste Management, C.13.2
- Liquid Waste Management, C.13.6
- Vehicle and Equipment Operations, C.15
- Vehicle and Equipment Maintenance, C.15.3
- Stockpile Management, C.17
- Water Conservation Practice, C.18
- Safer Alternative Products, C.21
- Illegal Connection and Illicit Discharge (IC/ID), C.22.3
- Illegal Spill Discharge Control, C.22.4
- Sweeping and Vacuuming, C.29

# K Family – Electrical

## Sawcutting for Loop Installation



*Good housekeeping at new metering station*

### Environmental Concerns

Discharge of the following materials into the stormwater drainage system or watercourse:

- Concrete
- Concrete slurry
- Fuel
- Non-stormwater
- Sealant
- Vehicle fluids

### DEFINITION AND PURPOSE

Detector loops are electrical sensors used to trigger a traffic signal at an intersection and/or for long-term traffic counts. Installation of detector loops is accomplished by cutting into the road surface with a concrete saw, inserting the electric wire into the cut and sealing the cut with loop sealant.

### OPERATIONAL PROCEDURES

The following procedures are used where saw cutting for loop installation may pollute stormwater runoff or discharge to stormwater drainage system and watercourses.

- Avoid cutting concrete and installing loop detectors during rain events.
- Protect drain inlets and watercourses from potential spills and debris.
- Avoid excess use of water to minimize runoff. Apply water only to the cutting site.
- Minimize the use of loop sealant by carefully estimating the amount needed. Clean-up excess loop sealant and place the collected material in a bucket or drum for transport to the Maintenance facility to be reused, recycled or disposed of properly.
- Do not remove original product label from paint or hazardous materials containers as it contains important spill cleanup and disposal information. Use the entire product before disposing of the container. Appropriately label all secondary containers.
- Vehicle and equipment washing is allowed only at designated rinsing areas, wash racks or other designated areas. All engine compartment and undercarriage rinsing/washing must be performed within a wash rack facility. The District Maintenance Stormwater Coordinator will approve or provide input on the approved location for a designated rinsing area.

## K FAMILY – ELECTRICAL

### Sawcutting for Loop Installation

#### OPERATIONAL PROCEDURES (CONT'D)

- Contain all sawcutting waste including water used to cool the cutting blade. Sweep or vacuum the site to collect all sawcutting waste prior to leaving the site.
- Liquid waste should be collected in a container with a secure lid for transport to the Maintenance facility for proper disposal.
- Solid waste should be collected by vacuum or sweeping and secured in an appropriate container for transport to the Maintenance facility to be reused, recycled or disposed of properly.

#### Applicable Maintenance BMPs in Appendix C

- Scheduling and Planning, C.3
- Storm Drain Inlet Protection, C.5
- Solid Waste Management, C.13.2
- Liquid Waste Management, C.13.6
- Concrete Waste Management, C.13.7
- Material Use, C.14.2
- Vehicle and Equipment Operations, C.15
- Water Conservation Practice, C.18
- Illegal Connection and Illicit Discharge (IC/ID), C.22.3
- Illegal Spill Discharge Control, C.22.4
- Sweeping and Vacuuming, C.29

# M Family – Traffic Guidance

## Thermoplastic Striping and Marking



*Applying thermoplastic strips with a propane heater*

### Environmental Concerns

Discharge of the following materials into the stormwater drainage system or watercourse:

- Fuel
- Grit
- Non-stormwater
- Plastic
- Sand
- Vehicle fluids

### DEFINITION AND PURPOSE

Thermoplastic materials are used for lane stripes and other pavement markings to guide motorists. Thermoplastic material is heated in a preheater and then applied to the pavement by thermoplastic striper or applicators.

### OPERATIONAL PROCEDURES

The following procedures are used where thermoplastic striping and marking may pollute stormwater runoff or discharge to stormwater drainage system and watercourses.

- This activity shall not be performed during rain events or prior to predicted rain events, unless required by emergency conditions.
- Prior to leaving the maintenance facility or work site, make certain all thermoplastic striper and preheater equipment shutoff valves are working properly to prevent leaking.
- The preheater should be filled carefully to prevent splashing or spilling of hot thermoplastic. Leave adequate space at the top of the container when filling thermoplastic to allow room for material to move when deadheading the vehicle.
- Do not preheat, transfer or load thermoplastic near stormwater drainage system or watercourses.
- Sweep or vacuum site to reduce the potential of material and debris entering the stormwater drainage system or watercourses and reduce the potential of tracking material and debris from the site.
- Solid waste should be collected by vacuum or sweeping and secured in an appropriate container for transport to the Maintenance facility to be reused, recycled or disposed of properly.



## M FAMILY – TRAFFIC GUIDANCE

### Thermoplastic Striping and Marking

#### Applicable Maintenance BMPs in Appendix C

- Scheduling and Planning, C.3
- Spill Prevention and Control, C.13.1
- Solid Waste Management, C.13.2
- Hazardous Waste Management, C.13.3
- Material Use, C.14.2
- Vehicle and Equipment Operations, C.15
- Safer Alternative Products, C.21
- Sweeping and Vacuuming, C.29
- Illegal Connection and Illicit Discharge (IC/ID), C.22.3
- Illegal Spill Discharge Control, C.22.4

## M FAMILY – TRAFFIC GUIDANCE

### Paint Striping and Marking



*Epoxy pavement markings operation*

#### Environmental Concerns

Discharge of the following materials into the stormwater drainage system or watercourse:

- Fuel
- Non-stormwater
- Paint
- Sediment
- Vehicle fluids

#### DEFINITION AND PURPOSE

Pavement striping and marking is used to supplement traffic signs and to guide and control vehicular and pedestrian traffic. Pavement striping delineates the separation of traffic flow on highways and freeways. Paints are applied to pavement by using stencil or striper paint systems.

#### OPERATIONAL PROCEDURES

The following procedures are implemented where paint striping and marking may pollute stormwater runoff or discharge to stormwater drainage system and watercourses.

- This activity shall not be performed during rain events or prior to predicted rain events, unless required by emergency conditions.
- Pre-sweeping should be accompanied by watering to reduce the amount of dust generated, if necessary. Avoid excess use of water to minimize runoff
- Be sure no pressure remains in paint striper system when setting up, cleaning, pulling filters or servicing spray guns. Release pressure on bead tank before removing lid.
- Check to make sure that the paint spray gun remains closed when not in use to prevent leaks. Check for leaking or ruptured paint containers.
- Paint should be loaded and mixed away from stormwater drainage system or watercourses. Monitor weather and wind direction to ensure that paint is not entering the stormwater drainage system or watercourses during spraying.
- Do not remove original product label from paint or other hazardous materials containers as it contains important spill cleanup and disposal information. Use the entire product before disposing of the container. Appropriately label all secondary containers.
- Liquid waste should be collected in a container with a secure lid and transported to the Maintenance facility for proper disposal.

## M FAMILY – TRAFFIC GUIDANCE

### Paint Striping and Marking

#### OPERATIONAL PROCEDURES (CONT'D)

- Solid waste should be collected by vacuum or sweeping and secured in an appropriate container for transport to the Maintenance facility to be reused, recycled or disposed of properly.
- Do not stockpile sediment in or near stormwater drainage system or watercourses.
- If pre-sweeping is needed, refer to Activity Cut-Sheets, D Family Sweeping Operations and D Family - Litter and Debris Removal.

#### Applicable Maintenance BMPs in Appendix C

- Scheduling and Planning, C.3
- Storm Drain Inlet Protection, C.5
- Spill Prevention and Control, C.13.1
- Solid Waste Management, C.13.2
- Liquid Waste Management, C.13.6
- Material Use, C.14.2
- Vehicle and Equipment Operations, C.15
- Stockpile Management, C.17
- Water Conservation Practice, C.18
- Safer Alternative Products, C.21
- Illegal Connection and Illicit Discharge (IC/ID), C.22.3
- Illegal Spill Discharge Control, C.22.4
- Sweeping and Vacuuming, C.29

## M FAMILY – TRAFFIC GUIDANCE

### Raised/Recessed Pavement Marker Application and Removal



#### Environmental Concerns

Discharge of the following materials into the stormwater drainage system or watercourse:

- Bitumen adhesive
- Epoxy
- Fuel
- Non-stormwater
- Vehicle fluids

Removing recess marker

#### DEFINITION AND PURPOSE

Pavement markers are used to supplement traffic signs and convey messages or direction to motorists. Pavement markers are either surface mounted (raised) or placed in recessed slots in the pavement. Markers are applied using bitumen/epoxy adhesives. Damaged or old markers are removed for replacement using hand tools or special attachments on a motor grader.

#### OPERATIONAL PROCEDURES

The following procedures are used where pavement marking and removal may pollute stormwater runoff or discharge to stormwater drainage system and watercourses.

- This activity shall not be performed during rain events or prior to predicted rain events, unless required by emergency conditions.
- Prior to leaving the maintenance facility or work site, ensure all shutoff valves on equipment are working properly to prevent spills.
- Melting tanks should be loaded with adequate space at the top to leave room for splashing when deadheading the vehicle.
- When servicing or filling melting tanks, ensure all pressure is released before removing lids to avoid spills.

## M FAMILY – TRAFFIC GUIDANCE

### Raised/Recessed Pavement Marker Application and Removal

- Do not pre-heat transfer or load bituminous material near stormwater drainage system or watercourses.
- Collect as much excess bituminous material and epoxy as possible from the roadway after removal of markers.
- Liquid waste should be collected in a container with a secure lid and transported to the Maintenance facility for proper disposal.
- Solid waste should be collected by vacuum or sweeping and put into bags or buckets and secured for transport to the Maintenance facility to be reused, recycled or disposed of properly.

#### Applicable Maintenance BMPs in Appendix C

- Scheduling and Planning, C.3
- Spill Prevention and Control, C.13.1
- Solid Waste Management, C.13.2
- Material Use, C.14.2
- Vehicle and Equipment Operations, C.15
- Illegal Connection and Illicit Discharge (IC/ID), C.22.3
- Illegal Spill Discharge Control, C.22.4

## M FAMILY – TRAFFIC GUIDANCE

### Sign Repair and Maintenance



*Post holing for new sign*

#### Environmental Concerns

Discharge of the following materials into the stormwater drainage system or watercourse:

- Concrete
- Debris
- Fuel
- Non-stormwater
- Sediment
- Vehicle fluids

#### DEFINITION AND PURPOSE

Sign installation may range from digging a hole for a small one-post roadside sign to more complex activities such as mounting large multi-panel signs on overhead sign structures. When signs are damaged or obsolete, they are replaced or removed.

#### OPERATIONAL PROCEDURES

The following procedures are used where sign installation and removal may pollute stormwater runoff or discharge to stormwater drainage system and watercourses.

- Be careful when digging in landscaped areas to avoid damaging buried water lines (call USA at 1-800-227-2600, or 1-800-422-4133), so as to prevent work area debris from being transported by flow from damaged water lines to stormwater drainage system or watercourses. Protect stormwater drainage system and watercourses in case a leak or spill does occur.
- Compaction should be performed as soon as possible after grading or soil disturbance.
- If concrete is used, do not allow concrete waste or slurry to enter stormwater drainage system or watercourses. Liquid waste and concrete washout should be collected in a container with a secure lid and transported to the Maintenance facility to be reused, recycled or disposed of properly. Concrete contractors are required to comply with Caltrans Standard Specification Section 13-9.
- Do not remove original product label from paint or hazardous materials containers as it contains important spill cleanup and disposal information. Use the entire product before disposing of the container. Appropriately label all secondary containers.
- Vehicle and equipment washing is allowed only at designated rinsing areas, wash racks or other designated areas. All engine compartment and undercarriage rinsing/washing must be performed within a wash rack facility. The District Maintenance Stormwater Coordinator will approve or provide input on the approved location for a designated rinsing area.

## M FAMILY – TRAFFIC GUIDANCE

### Sign Repair and Maintenance

#### OPERATIONAL PROCEDURES (CONT'D)

- Sweep or vacuum prior to leaving the site to reduce the potential of tracking litter, debris and sediment onto public roadways.

Debris from damaged signposts should be collected and secured in an appropriate container for transport back to the Maintenance facility to be reused, recycled or disposed of properly.

#### Applicable Maintenance BMPs in Appendix C

- Scheduling and Planning, C.3
- Compaction, C.7.1
- Solid Waste Management, C.13.2
- Material Use, C.14.2
- Vehicle and Equipment Operations, C.15
- Illegal Connection and Illicit Discharge (IC/ID), C.22.3
- Illegal Spill Discharge Control, C.22.4



## M FAMILY – TRAFFIC GUIDANCE

### Median Barrier and Guard Rail Repair



*Guardrail repair in progress*

#### Environmental Concerns

Discharge of the following materials into the stormwater drainage system or watercourse:

- Concrete
- Debris
- Fuel
- Non-stormwater
- Vehicle fluids

#### DEFINITION AND PURPOSE

Median barriers and guardrails may require repair following an accident, or as part of routine maintenance activities.

#### OPERATIONAL PROCEDURES

The following procedures are used where median barrier and guardrail repair may pollute stormwater runoff or discharge to stormwater drainage system and watercourses.

- Be careful when digging in landscaped areas to avoid damaging buried water lines (call USA at 1-800-227-2600, or 1-800-422-4133), so as to prevent work area debris from being transported by flow from damaged water lines to stormwater drainage system or watercourses. Protect drainage inlets, stormwater drainage system and watercourses in case a leak or spill does occur.
- Stabilize the entrance/exits to the work area, if necessary, to avoid tracking mud or sediments on to public roadways.
- Compaction should be performed as soon as possible after grading or soil disturbance.
- If concrete is used, do not allow concrete waste or slurry to enter stormwater drainage system or watercourses. Concrete contractors are required to comply with Caltrans Standard Specification Section 13-9 Temporary Concrete Washouts.
- Do not remove original product label from paint or hazardous materials containers as it contains important spill cleanup and disposal information. Use the entire product before disposing of the container. Appropriately label all secondary containers.
- Vehicle and equipment washing is only allowed at designated rinsing areas, wash racks or other designated areas. All engine compartment and undercarriage rinsing/washing must be performed within a wash rack facility. The District Maintenance Stormwater Coordinator will approve or provide input on the approved location for a designated rinsing area.

## M FAMILY – TRAFFIC GUIDANCE

### Median Barrier and Guard Rail Repair

#### OPERATIONAL PROCEDURES (CONT'D)

- Sweep or vacuum the site. If working off-road, inspect and remove rock and sediment from tires prior to leaving the site to reduce the potential of tracking litter, debris and sediment onto public roadways.
- Collect all debris from damaged guardrail or median barrier. Solid waste should be secured in an appropriate container for transport to the Maintenance facility to be reused, recycled or disposed of properly.

#### Applicable Maintenance BMPs in Appendix C

- Scheduling and Planning, C.3
- Compaction, C.7.1
- Stabilized Activity Entrance/Exit, C.12.1
- Tire Inspection and Sediment Removal, C.12.2
- Solid Waste Management, C.13.2
- Concrete Waste Management, C.13.7
- Vehicle and Equipment Operations, C.15
- Water Conservation Practice, C.18
- Illegal Connection and Illicit Discharge (IC/ID), C.22.3
- Illegal Spill Discharge Control, C.22.4
- Sweeping and Vacuuming, C.29

## M FAMILY – TRAFFIC GUIDANCE

### Emergency Vehicle Energy Attenuator Repair



#### Environmental Concerns

Discharge of the following materials into the stormwater drainage system or watercourse:

- Debris
- Fuel
- Non-stormwater
- Sediment (sand)
- Vehicle fluids

*Crash attenuators*

#### DEFINITION AND PURPOSE

Emergency Vehicle Energy Attenuators, or Impact Energy Attenuators, are intended to reduce the severity of a collision with a fixed object that cannot be removed or protected by other types of protective systems. Vehicle Energy Attenuators are typically canisters, which are filled with water or sand, or are of a lightweight, crushable design. Vehicle Energy Attenuators require periodic maintenance to ensure that they are viable and in the correct position following contact with a moving vehicle.

#### OPERATIONAL PROCEDURES

The following procedures are used where vehicle energy attenuator repair may pollute stormwater runoff or discharge to stormwater drainage system and watercourses.

- Protect drain inlets and watercourses from potential spills, debris and energy attenuator materials.
- During clean up and repair operations, make sure that all debris is removed.
- Cleanup and properly dispose of any vehicle fluids or parts, and attenuator debris.
- Liquid waste should be collected in a container with a secure lid and transported to the Maintenance facility or decanting area for proper disposal.
- Solid waste should be collected by vacuum or sweeping and secured in an appropriate container for transport to the Maintenance facility to be reused, recycled or disposed of properly.

## M FAMILY – TRAFFIC GUIDANCE

### Emergency Vehicle Energy Attenuator Repair

#### Applicable Maintenance BMPs in Appendix C

- Storm Drain Inlet Protection, C.5
- Spill Prevention and Control, C.13.1
- Solid Waste Management, C.13.2
- Vehicle and Equipment Operations, C.15
- Water Conservation Practice, C.18
- Illegal Connection and Illicit Discharge (IC/ID), C.22.3
- Illegal Spill Discharge Control, C.22.4
- Sweeping and Vacuuming, C.29

# R Family – Snow/Ice Control

## Snow Removal



*Snow plow cleaned and on standby*

### Environmental Concerns

Discharge of the following materials into the stormwater drainage system or watercourse:

- Fuel
- Non-stormwater
- Sediment (sand)
- Vehicle fluids

### DEFINITION AND PURPOSE

Snow removal includes all work in connection with snow removal, drift prevention, installation and maintenance of snow fences, snow pole installation and removal.<sup>4</sup>

### OPERATIONAL PROCEDURES

Proper snow removal will reduce the discharge of sediment and potential pollutants to the stormwater drainage system or watercourses.

- Where possible, avoid blowing or pushing snow or other debris into watercourses, the stormwater drainage system, or where a storm drain inlet can be blocked.
- When necessary, sweep after storms to remove sand and cinders and dispose of properly.



*Snow pole installation*

<sup>4</sup> Snow removal is considered an emergency operation due to insufficient forecast of extent, duration, severity and location of hazard presented to the public.

## R FAMILY – SNOW/ICE CONTROL

### Snow Removal

#### Applicable Maintenance BMPs in Appendix C

- Scheduling and Planning, C.3
- Vehicle and Equipment Operations, C.15
- Safer Alternative Products, C.21
- Illegal Spill Discharge Control, C.22.4
- Snow Removal and De-Icing Agents, C.27



## R FAMILY – SNOW/ICE CONTROL

### Ice Control



Salt storage house

#### Environmental Concerns

Discharge of the following materials into the stormwater drainage system or watercourse:

- Deicing agents (salt)
- Fuel
- Non-stormwater
- Sediment
- (sand, cinder)
- Vehicle fluids

#### DEFINITION AND PURPOSE

Ice control involves the use of deicing agents and abrasives to maintain public safety.<sup>5</sup>

#### OPERATIONAL PROCEDURES

Proper ice control will reduce the discharge of deicing agents and sediment to the stormwater drainage system or watercourses.

- Where necessary, sweep after storms to remove sand and cinders and dispose of properly.
- District 2, 3, 8, 9 and 10 should record the volume of abrasives and deicing materials used within the Lahontan Region on each major route. Recommended salt application rates can be found in Chapter R of the *Caltrans Maintenance Manual Vol. 1*.
- Routinely calibrate spreaders. Because of potentially detrimental effects of deicing agents, personnel should use no more than is necessary for effective ice control.
- Use road abrasives that have been washed, screened, or graded to reduce silt and clay to insignificant levels.
- When using detergents, wash equipment used in the application of deicing agents at a wash area that discharges to a sanitary sewer system or water recovery system.
- Where possible, avoid blowing or pushing ice, snow, abrasives, or other debris into watercourse, the stormwater drainage system or where a storm drain inlet can be blocked.
- Where possible, store sand in covered stockpiles in areas where a frozen crust will not form on the stockpile.

<sup>5</sup> Ice control is considered an emergency operation due to insufficient forecast of extent, duration, severity and location of hazard presented to the public.



## R FAMILY – SNOW/ICE CONTROL

### Ice Control

#### OPERATIONAL PROCEDURES (CONT'D)

- Store deicing agents in covered areas, bunkers, or storage buildings. Do not store deicing chemicals where they will come in contact with stormwater runoff

#### Applicable Maintenance BMPs in Appendix C

- Scheduling and Planning, C.3
- Material Use, C.14.2
- Material Loading and Unloading, C.14.3
- Safer Alternative Products, C.21
- Illegal Connection and Illicit Discharge (IC/ID), C.22.3
- Illegal Spill Discharge Control, C.22.4
- Snow Removal and De-Icing Agents, C.27
- Sweeping and Vacuuming, C.29

# S Family – Storm/Major Damage

## Minor Slides and Slipouts Cleanup/Repair



Slide area swept and temporarily repaired with plastic sheeting

### Environmental Concerns

Discharge of the following materials into the stormwater drainage system or watercourse:

- Asphalt
- Debris
- Fuel
- Non-stormwater
- Sediment
- Vehicle fluids

### DEFINITION AND PURPOSE

Repair of minor slides and slip-outs includes cleaning up or backfilling minor slides and minor damage to the roadside. Soil, rocks and boulders deposited on the roadway are removed, and minor erosion damage can be repaired. Downed or damaged vegetation may also be removed.

### OPERATIONAL PROCEDURES

The following procedures are used where the repair and cleanup of slides and slip outs may pollute stormwater runoff or discharge to stormwater drainage system and watercourses.

- Prior to working in a water body or wetland, alternatives should first be considered. If still deemed necessary, the appropriate permits must be obtained.

## S FAMILY – STORM/MAJOR DAMAGE

### Minor Slides and Slipouts Cleanup/Repair

#### OPERATIONAL PROCEDURES (CONT'D)

- Locate and protect stormwater drainage systems and watercourses downstream of the area where minor slides and slip-outs are being repaired or cleared.
- Stabilize the entrance/exits to the work area with soil stabilizers as necessary.
- When clearing the roadside of downed or damaged vegetation, avoid placing the vegetation near drain inlets, watercourses or drainage ditches.
- Tires should be cleaned before entering the water, equipment should be cleaned of petroleum residue, and water levels should be kept below the gearboxes of equipment. All lubricants and fuels should be properly sealed.



*Minor slipout repaired with rock*

- Remove sediment build up behind check dams prior to accumulation reaching one-third of the check dam height. Remove check dam when no longer needed.
- Preserve existing vegetation by defining the work area and replace the damaged vegetation outside the defined work area.
- When using dewatering measures, ensure that discharge does not cause erosion.
- Disturbed soil areas shall be stabilized to avoid erosion.
- Control dust and erosion in windy or wind-prone areas using covers, water or soil stabilizers.
- Do not stockpile sediment or concrete rubble in or near stormwater drainage system or watercourses. Protect stockpiles with a cover or sediment barriers during rainstorms.
- Inspect and remove rock and sediment from tires prior to leaving the site to reduce the potential of tracking litter, debris and sediment from the site.
- Solid waste should be collected by vacuum or sweeping and secured in an appropriate container for transport to the Maintenance facility to be reused, recycled or disposed of properly. Remove stockpile of slide materials from temporary sites within 12 months to avoid converting the site into a permanent storage site with further requirements such as FPPP and monthly inspections. Implement stockpile management while slide materials are on temporary storage.

## S FAMILY – STORM/MAJOR DAMAGE

### Minor Slides and Slipouts Cleanup/Repair

#### Applicable Maintenance BMPs in Appendix C

- Sediment Control, C.4
- Storm Drain Inlet Protection, C.5
- Overside/ Slope Drains, C.6.1
- Ditches, Berms, Dikes and Swales, C.6.2
- Temporary Diversion Ditches, C.6.3
- Soil Stabilization, C.7
- Preservation of Existing Vegetation, C.8
- Work in a Water Body, C.10
- Wind Erosion Control, C.11
- Stabilized Activity Entrance/Exit, C.12.1
- Tire Inspection and Sediment Removal, C.12.2
- Solid Waste Management, C.13.2
- Vehicle and Equipment Operations, C.15
- Stockpile Management, C.17
- Illegal Connection and Illicit Discharge (IC/ID), C.22.3
- Illegal Spill Discharge Control, C.22.4
- Slopes Prone to Erosion and Sediment Discharge, C.26
- Stormwater Dewatering Operation, C.28
- Sweeping and Vacuuming, C.29

# T Family – Support

## Building and Grounds Maintenance



*Well maintained facility grounds*

Environmental Concerns	
Discharge of the following materials into the stormwater drainage system or watercourse:	
• Fertilizer	• Pesticides/herbicides
• Fuel	• Sediment
• Litter	• Sewage
• Non-stormwater <sup>6</sup>	• Trash
	• Vehicle fluids

### DEFINITION AND PURPOSE

Permanent Maintenance facilities require building and grounds maintenance, including landscaping, parking and pavement surfaces, maintenance activity operations and stormwater drainage systems.

### OPERATIONAL PROCEDURES

The following procedures are used where building and grounds maintenance may pollute stormwater runoff or discharge to stormwater drainage system and watercourses.

#### Building Maintenance

- Inspect storm drains regularly for litter and debris. Clean stormwater drainage systems in the fall before the first rains, and as often as necessary to keep litter and debris out of the stormwater.
- Minimize water use in washing activities.
- Properly dispose of wash water generated by building maintenance activities. Dispose of wash water to the sanitary sewer system.
- Dispose of sweepings and cleaning wastes as solid waste.
- Sanitary and septic waste shall be discharged to a sanitary sewer or managed by a licensed hauler.

---

<sup>6</sup> Irrigation water and landscape irrigation are conditionally exempt discharges if appropriate control measures are developed and implemented under the SWMP.

## T FAMILY – SUPPORT

### Building and Grounds Maintenance

#### OPERATIONAL PROCEDURES (CONT'D)

##### Grounds Maintenance

- The maintenance facility should be routinely swept to keep litter and sediment out of drainage systems.
- Apply fertilizers and pesticides in accordance with the label instructions. See Activity Cut-Sheet, E Family - Chemical Vegetation Control. Use integrated pest management where appropriate.
- Do not remove original product label from paint or hazardous materials containers as it contains important spill cleanup and disposal information. Use the entire product before disposing of the container. Appropriately label all secondary containers.
- Avoid excessive irrigation of landscaped areas to minimize potential runoff.
- Control erosion and sediment runoff.
- Preserve existing vegetation by defining the work area and replace the damaged vegetation outside the defined work area.
- Locate stockpiles at least 50 feet from downstream drain inlets or watercourses.
- All wastes should be put into containers and stored appropriately until it can be recycled or disposed of properly.
- All materials of environmental concern shall be properly stored in appropriate secure containment. See Activity Cut-Sheet, T Family - Storage of Hazardous Materials (Working Stock).
- See Activity Cut Sheet, E Family - Irrigation (Watering), Potable and Non-potable.

## T FAMILY – SUPPORT

### Building and Grounds Maintenance

#### Applicable Maintenance BMPs in Appendix C

- Scheduling and Planning, C.3
- Sediment Control, C.4
- Compaction, C. 7.1
- Preservation of Existing Vegetation, C.8
- Spill Prevention and Control, C.13.1
- Solid Waste Management, C.13.2
- Hazardous Waste Management, C.13.3
- Sanitary/Septic Waste Management, C.13.5
- Liquid Waste Management, C.13.6
- Concrete Waste Management, C.13.7
- Material Delivery and Storage, C.14.1
- Material Loading and Unloading, C.14.3
- Material Use, C.14.2
- Vehicle and Equipment Operations, C.15
- Stockpile Management, C.17
- Water Conservation Practice, C.18
- Potable Water/Irrigation, C.19
- Storm Drain Stenciling, C.20
- Safer Alternatives Products, C.21
- Illegal Spill Discharge Control, C.22.4
- Litter and Debris, C.24.1
- Chemical Vegetation Control, C.25
- Sweeping and Vacuuming, C.29
- Maintenance Facility Housekeeping Practices, C.30



## T FAMILY – SUPPORT

### Storage of Hazardous Materials (Working Stock)



*Treated wood and working stock stored in covered sheds*

#### Environmental Concerns

Discharge of the following materials into the stormwater drainage system or watercourse:

- Asphalt products
- Cement
- Epoxy resins
- Fertilizer
- Fuel
- Paints
- Pesticides/herbicides
- Solvents
- Vehicle fluids

#### DEFINITION AND PURPOSE

Maintenance facilities store a variety of products which may be harmful to the environment if they come in contact with surface waters.

#### OPERATIONAL PROCEDURES

The following procedures are used to reduce the potential for the discharge of materials from hazardous material storage sites to the stormwater drainage system or watercourses by minimizing exposure of the materials to stormwater and safeguarding against accidental release of materials.

The BMPs for this activity provide operating methods or measures only for the purpose of stormwater pollution prevention. The applicable local, state and federal hazardous materials, employee safety and fire prevention requirements are not presented. Although not a BMP, it should be acknowledged that other environmental laws and regulations do require spill or secondary containment for some hazardous materials and waste.

Proper hazardous materials storage procedures can be found in the Hazardous Materials Business Plan. Maintenance facilities that store hazardous materials at or above the regulated thresholds will have a Hazardous Materials Business Plan as required by regulation. Hazardous materials storage must conform to this plan.

- Store hazardous materials in a designated area containing chemically compatible materials. Do not store incompatible products in the same storage area without some type of physical barrier separating the containers. For example, do not store strong oxidizers with organics, or flammable/combustible materials. Where feasible, store hazardous materials under cover and away from areas that might drain into the stormwater drainage system or watercourses. Ensure container covers or caps are secure.
- Do not remove original product label from paint or hazardous materials containers as it contains important spill cleanup and disposal information. Use the entire product before properly disposing of the container. Appropriately label all secondary containers.

## T FAMILY – SUPPORT

### Storage of Hazardous Materials (Working Stock)

#### OPERATIONAL PROCEDURES (CONT'D)

- Install safeguards to prevent accidental releases such as overflow protection devices, automatic shutdown transfer pumps, protection guards around tanks and piping to prevent vehicle or forklift damage. Limit access to unauthorized persons.
- Review Safety Data Sheets with personnel on proper labeling requirements, spill cleanup procedures and disposal of hazardous materials.
- Regularly inspect and maintain hazardous materials storage areas to minimize exposure to stormwater. Use the Daily/Weekly/Monthly inspection form. Store hazardous materials on impervious surfaces if possible.
- Maintain spill cleanup materials near the storage area. Cleanup spills or leaks immediately if it is safe to do so.
- Store used lead acid batteries in spill or secondary containment. All cracked batteries shall be stored in spill containment.

#### Regular Maintenance of Outdoor Container Storage Area

- Inspect storage areas as required. Ensure all containers are properly labeled, with lids securely fastened, and in good condition.
- If a container is corroded or leaking, contact the District Hazardous Material Coordinator or Manager to have the waste or material transferred to a new container by trained and qualified personnel. Label the new container appropriately and properly dispose of the old container.

#### Paint Storage Area

- Inspect all paint pallets to ensure that all product containers are secured before transfer or transportation.
- Load and off-load paint on level ground when using a forklift to minimize possible spills and ruptures of paint containers.
- Where feasible, store paint materials in an area with a canopy or roof designed to direct runoff away from the area.

#### Applicable Maintenance BMPs in Appendix C

- Scheduling and Planning, C.3
- Spill Prevention and Control, C.13.1
- Material Delivery and Storage, C.14.1
- Material Loading and Unloading, C.14.3
- Vehicle and Equipment Operations, C.15
- Safer Alternative Products, C.21

## T FAMILY – SUPPORT

### Storage of Hazardous Materials (Working Stock)

#### Wood Post Storage Area

- Cover treated wood posts during the forecasted rain events using “Block and Tarp”, “Containerize”, “Storage Building”, or “Contaminated Pad” method.
- Treated wood waste shall not be scavenged or burned.

## T FAMILY – SUPPORT

### Material Storage Control (Hazardous Waste)



#### Environmental Concerns

Discharge of the following materials into the stormwater drainage system or watercourse:

- Asphalt products
- Fuel
- Lead-acid batteries
- Paints
- Solvents
- Vehicle fluids

*Hazardous waste stored in locked double-contained storage units*

#### DEFINITION AND PURPOSE

Maintenance facilities store a variety of products that may adversely impact water quality if they come in contact with surface waters.

#### OPERATIONAL PROCEDURES

These procedures are applicable to all maintenance facilities that store any material considered by the State of California or federal regulations to be hazardous waste, and intended to reduce the potential for the discharge of hazardous waste to stormwater drainage system or watercourses by providing safeguards against accidental releases.

The BMPs for this activity provide operating methods or measures only for the purpose of stormwater pollution prevention. The applicable local, state and federal hazardous materials, employee safety and fire prevention requirements are not presented.

Although not a BMP, it should be acknowledged that other environmental laws and regulations do require spill or secondary containment for some hazardous materials and waste.

- Weekly inspections are required for hazardous waste storage areas. Use the Daily/Weekly/Monthly inspection form. Storage areas should be properly secured to prevent unauthorized access.
- Hazardous waste shall be stored in appropriate containers, with lids securely fastened, constructed of compatible materials and properly labeled in accordance with federal, state and local regulations. Refer to the Maintenance Hazardous Waste Manual for the management of containers.
- Containment facilities shall provide for appropriate spill containment volume.

## T FAMILY – SUPPORT

### Material Storage Control (Hazardous Waste)

#### OPERATIONAL PROCEDURES (CONT'D)

- Hazardous waste shall have secondary containment that will provide within its boundary:
  - Spill containment volume of 10% of the total volume of all containers, or 100% of the capacity of the largest container, whichever is greater.
  - Impervious containment and compatibility to the materials in storage.
- Secondary containment volume outdoors should account for precipitation from a 24-hour, 25-year storm event, and should be maintained free of rainwater and spills at all times.
- Maintain an ample supply of appropriate spill cleanup materials near hazardous materials storage areas.

In the event of a spill, dry cleanup methods should be used. Contaminated cleanup materials, contaminated materials and recovered spill material shall be disposed of properly.

#### Applicable Maintenance BMPs in Appendix C

- Scheduling and Planning, C.3
- Spill Prevention and Control, C.13.1
- Hazardous Waste Management, C.13.3
- Material Delivery and Storage, C.14.1
- Material Loading and Unloading, C.14.3
- Vehicle and Equipment Operations, C.15
- Illegal Spill Discharge Control, C.22.4

## T FAMILY – SUPPORT

### Outdoor Storage of Raw Materials



*Materials stored in covered sheds, bins or shipping containers*

#### Environmental Concerns

Discharge of the following materials into the stormwater drainage system or watercourse:

- Asphalt products
- Deicing agents
- Fuel
- Sand
- Vehicle fluids

#### DEFINITION AND PURPOSE

Maintenance facilities store a variety of raw materials that may adversely impact water quality if they come in contact with surface waters.

#### OPERATIONAL PROCEDURES

These procedures are applicable to all maintenance facilities that store raw material such as asphalt, sand, soils, treated wood posts and mulch outdoors, and are intended to reduce the potential for discharges of potential pollutants to stormwater drainage system or watercourses.

- Inspect storage areas regularly. Use the Daily/Weekly/Monthly inspection form.
- Protect storm drain inlets and watercourses from potential spills of raw materials.
- Maintain spill cleanup materials and tools. Cleanup spills immediately, if it is safe to do so, and dispose of any generated waste properly.
- Keep surfaces swept clean where material is blown or washed from the storage area, keeping materials covered and keeping storage containers in good condition.
- Store materials at least 50 feet from stormwater drainage systems or watercourses.
- Where feasible, cover the storage area with a canopy or roof that is designed to direct the runoff away from the storage area, or cover (tarp) dry materials to prevent water intrusion during the winter season.
- During rain events, stockpiles of cold-mix asphalt shall be covered. Other stockpiles shall be covered or protected with soil stabilization measures or a perimeter sediment barrier. Contact the District Maintenance Stormwater Coordinator if problems arise. Inspect storage areas regularly. Use the Daily/Weekly/Monthly inspection form.

## T FAMILY – SUPPORT

### Outdoor Storage of Raw Materials

#### Applicable Maintenance BMPs in Appendix C

- Scheduling and Planning, C.3
- Spill Prevention and Control, C.13.1
- Material Delivery and Storage, C.14.1
- Material Loading and Unloading, C.14.3
- Vehicle and Equipment Operations, C.15
- Stockpile Management, C.17
- Safer Alternative Products, C.21
- Weighted Fiber Rolls, C.4.7
- Illegal Spill Discharge Control, C.22.4
- Maintenance Facility Housekeeping Practices, C.30



## T FAMILY – SUPPORT

### Vehicle and Equipment Fueling



*Fueling station well maintained; no concrete staining*

#### Environmental Concerns

Discharge of the following materials into the stormwater drainage system or watercourse:

- Fuel

#### DEFINITION AND PURPOSE

When vehicle and equipment fueling takes place at a maintenance facility, there is the potential for fuel to be leaked or spilled at the site. The procedures for vehicle and equipment fueling are designed to minimize contact between stormwater runoff and spilled fuel, oil or other leaked vehicle fluids at equipment fueling areas.

#### OPERATIONAL PROCEDURES

These procedures should be used at all equipment fueling areas.

- Fuel tanks and fuel dispensers shall have current permits with the appropriate agencies.
- Personnel at maintenance facility shall be trained to ensure that materials are properly handled and stored.
- Inspect all aboveground fueling tanks and fueling dispensers daily, using the Daily Inspection Form. Report any nozzle, hose leaks or malfunctions to the Supervisor immediately. Repair as necessary.
- When in use, inspect portable fueling tanks regularly for cracks and leaks. Repair as necessary.
- Proper fueling and spill cleanup instructions shall be posted at fueling areas.
- Clean up spills immediately, if it is safe to do so, using dry cleanup techniques and materials.
- Hosing down of leaks, drips and spills is prohibited.
- Automatic shut-off valves shall be installed at each pump where required. Manual shut-off valves shall be near fuel pumps and clearly posted where required.
- Spill cleanup materials and spill control equipment shall be maintained near fueling areas to clean up spills. Spills should be cleaned immediately and waste disposed of properly.

## T FAMILY – SUPPORT

### Vehicle and Equipment Fueling

#### Applicable Maintenance BMPs in Appendix C

- Spill Prevention and Control, C.13.1
- Material Delivery and Storage, C.14.1
- Vehicle and Equipment Fueling, C.15.2

## T FAMILY – SUPPORT

### Vehicle and Equipment Cleaning



*Washwater contained in wash rack*

#### Environmental Concerns

Discharge of the following materials into the stormwater drainage system or watercourse:

- Cleaning agents
- Fuel
- Metals
- Non-stormwater
- Sediment
- Vehicle fluids

#### DEFINITION AND PURPOSE

When vehicle and equipment cleaning is conducted at a Maintenance facility, it is essential that the wash water not be disposed to the stormwater drainage system or watercourses.

#### OPERATIONAL PROCEDURES

Proper vehicle and equipment cleaning minimizes contact between stormwater runoff and the equipment washing area, and ensures that the wash water is not discharged to the stormwater drainage system or watercourses.

- Vehicle and equipment washing areas should be inspected daily and cleaned as needed.
- The sump should be serviced regularly.
- Use designated areas for rinsing of vehicles and equipment to capture solid materials and minimize waste.
- Vehicle washing activities should be located at a structure or building equipped with a municipal sewer connection or closed loop system.
- If a washing area must be located outdoors, the area should have the following characteristics: The area should be surrounded by berms or graded to minimize contact with stormwater running onto the area. The area should be paved with concrete. The pressure washing area should drain to a dead-end sump or directly into the sanitary sewer system.
- Wash water containing cleaning solutions such as detergents and degreasers, or hydrocarbons, shall be prevented from entering the stormwater drainage system or watercourses.
- Approved safer alternative products should be used where practical and effective.
- Do not remove original product label from paint or hazardous materials containers as it contains important spill cleanup and disposal information. Use the entire product before disposing of the container. Appropriately label all secondary containers.

## T FAMILY – SUPPORT

### Vehicle and Equipment Cleaning

- Water usage should be minimized.

#### Applicable Maintenance BMPs in Appendix C

- Liquid Waste Management, C.13.6
- Material Use, C.14.2
- Vehicle and Equipment Cleaning, C.15.1
- Water Conservation Practice, C.18
- Illegal Spill Discharge Control, C.22.4

## T FAMILY – SUPPORT

### Vehicle and Equipment Maintenance and Repair



#### Environmental Concerns

Discharge of the following materials into the stormwater drainage system or watercourse:

- Fuel
- Lead-acid batteries
- Metals
- Vehicle fluids
- Paint products
- Used oil filters

*Well maintained supplies for vehicle repair*

#### DEFINITION AND PURPOSE

Vehicle and equipment maintenance and repair may include vehicle fluid removal, engine and parts cleaning, body repair and painting.

#### OPERATIONAL PROCEDURES

This procedure is intended to reduce the discharge of potential pollutants from areas in which vehicle maintenance and repair activities are conducted by employing controls which minimize contact between stormwater and the activity areas and products used in each activity.

- Outdoor vehicle and equipment maintenance shall not be performed during rain events or prior to predicted rain events unless required by emergency conditions.
- Maintenance activity areas should be kept clean, well organized and equipped with cleanup supplies.
- Use absorbent pads, drip pans or absorbent material as appropriate. If rags and absorbents are saturated or contaminated with high concentrations of regulated hazardous materials, dispose of rags and absorbents as hazardous waste.

#### Vehicle Fluid Removal

- Transfer removed vehicle fluids to recycling storage tank or drums by the end of the shift (daily).
- Transfer fluids from drip pans or other temporary containers into recycling storage tanks or drums by the end of the shift (daily).
- Ensure safeguards, such as oil shut-off valves, are installed and maintained on recovery equipment.

## T FAMILY – SUPPORT

### Vehicle and Equipment Maintenance and Repair

#### OPERATIONAL PROCEDURES (CONT'D)

##### Engine and Parts Cleaning

- Use self-contained sinks or tanks when working with solvents. Periodically check degreasing solvent tanks for leaks. Make necessary repairs as soon as possible. Report leaks or malfunctions to the Supervisor immediately.
- Allow parts to drain over the solvent sink or tank. Do not allow the solvents to drip or spill onto the floor. Allow parts to dry over the hot tank, if available. If rinsing is required, rinse over the hot tank.
- When finished using parts washer, be sure to shut it off, close the unit and cleanup area.

##### Body Repair and Painting

- When receiving damaged vehicles, inspect for fluid leaks and use drip pans, if necessary.
- Minimize use of "hose-off degreasers" to clean body parts before painting. Discharge wash water to sanitary sewer system.
- Use a shop vacuum to clean up dust from sanding material. Do not use vacuums for flammable liquids. Debris from wet sanding can be allowed to dry overnight then swept or vacuumed. Dispose of dust as solid waste.
- Minimize waste paint and thinner by carefully calculating paint needs based on surface area and using proper sprayer cup size.
- Do not use water to control overspray or dust in the paint booth unless you collect this wastewater. This water is to be treated prior to discharge into the sanitary sewer system.
- Clean spray guns in a self-contained cleaner. Recycle the cleaning solution when it becomes too dirty to use. Do not discharge cleaning waste to the sewer or storm drain.



*Well maintained vehicle repair stall*

##### Drain Control

- Keep internal floor drains plugged unless they drain to the sanitary sewer. Use dry cleanup methods, such as sweeping, when possible.
- Keep spill control equipment and covers available to protect external drain inlets.

## T FAMILY – SUPPORT

### Vehicle and Equipment Maintenance and Repair

#### Applicable Maintenance BMPs in Appendix C

- Spill Prevention and Control, C.13.1
- Solid Waste Management, C.13.2
- Hazardous Waste Management, C.13.3
- Liquid Waste Management, C.13.6
- Vehicle and Equipment Maintenance, C.15.3
- Safer Alternative Products, C.21
- Illegal Spill Discharge Control, C.22.4
- Maintenance Facility Housekeeping Practices, C.30



## T FAMILY – SUPPORT

### Aboveground and Underground Tank Leak and Spill Control



#### Environmental Concerns

Discharge of the following materials into the stormwater drainage system or watercourse:

- Emulsions
- Fuel
- Vehicle fluids

Emergency spill kit present with proper signage

#### DEFINITION AND PURPOSE

Maintenance facilities may use aboveground storage tanks for storage of bulk quantities of liquids.

#### OPERATIONAL PROCEDURES

This procedure is intended to reduce the discharge of pollutants to storm water drainage system or watercourses from storage tanks by installing safeguards against accidental releases.

- Review the Spill Prevention Control and Countermeasures (SPCC) plan for the Maintenance facility aboveground tank(s) if available.
- Tanks, hoses and pumps shall be maintained and inspected daily.
- Maintain good housekeeping practices and cleanup leaks or drips immediately, if it is safe to do so.
- If a spill occurs, protect drain inlets from the releases if safe to do so.
- Maintain an ample amount of spill cleanup materials near the tanks. Clean spills immediately, if it is safe to do so, and dispose of waste properly. Use dry cleanup techniques when possible.
- Rainwater in spill containment is to be inspected or tested before it is discharged. Drain valves shall be closed after releasing clean rainwater.

#### Applicable Maintenance BMPs in Appendix C

- Scheduling and Planning, C.3
- Storm Drain Inlet Protection, C.5
- Spill Prevention and Control, C.13.1
- Hazardous Waste Management, C.13.3
- Liquid Waste Management, C.13.6
- Maintenance Facility Housekeeping Practices, C.30
- Material Delivery and Storage, C.14.1
- Illegal Spill Discharge Control, C.22.4

# Appendix C – Maintenance BMPs

C.1 Maintenance BMPs .....	4
C.2 Maintenance Activity Table .....	5
C.3 Scheduling and Planning .....	13
C.4 Sediment Control.....	15
C.4.1 Silt Fence .....	16
C.4.2 Sandbag or Gravel Bag Barrier.....	20
C.4.3 Straw Bale Barrier .....	24
C.4.4 Fiber Rolls.....	27
C.4.5 Check Dam .....	31
C.4.6 Sediment Trap .....	33
C.4.7 Weighted Fiber Rolls .....	36
C.4.8 Compost Sock .....	38
C.4.9 Flexible Sediment Barrier .....	41
C.5 Storm Drain Inlet Protection .....	44
C.6 Concentrated Flow Conveyance Controls .....	49
C.6.1 Overside/Slope Drains.....	50
C.6.2 Ditches, Berms, Dikes and Swales .....	52
C.6.3 Temporary Diversion Ditches .....	54
C.7 Soil Stabilization.....	55
C.7.1 Compaction .....	56
C.7.2 Wood Mulch.....	57
C.7.3 Hydraulic Mulch.....	58
C.7.4 Hydroseeding/Handseeding.....	59
C.7.5 Soil Binders.....	60
C.7.6 Straw Mulch.....	62
C.7.7 Geotextiles, Mats/Plastic Covers and Erosion Control Blankets .....	63
C.7.8 Riprap (Rock Slope Protection) .....	69
C.8 Preservation of Existing Vegetation.....	71
C.9 Clear-Water Diversion .....	73
C.10 Work in a Waterbody.....	75
C.11 Wind Erosion Control .....	77
C.12 Tracking Control .....	78
C.12.1 Stabilized Activity Entrance/Exit .....	79
C.12.2 Tire Inspection and Sediment Removal .....	81
C.13 Waste Management.....	82
C.13.1 Spill Prevention and Control.....	83
C.13.2 Solid Waste Management .....	85

C.13.3 Hazardous Waste Management.....	88
C.13.4 Contaminated Soil Management .....	90
C.13.5 Sanitary/Septic Waste Management.....	92
C.13.6 Liquid Waste Management.....	93
C.13.7 Concrete Waste Management.....	97
C.14 Materials Handling .....	99
C.14.1 Material Delivery and Storage .....	100
C.14.2 Material Use.....	102
C.14.3 Material Loading and Unloading .....	104
C.15 Vehicle and Equipment Cleaning.....	106
C.15.1 Vehicle and Equipment Cleaning .....	107
C.15.2 Vehicle and Equipment Fueling.....	109
C.15.3 Vehicle and Equipment Maintenance .....	111
C.16 Paving Operations Procedures .....	113
C.17 Stockpile Management .....	115
C.18 Water Conservation Practices.....	119
C.19 Potable Water/Irrigation .....	120
C.20 Storm Drain Stenciling .....	121
C.21 Safer Alternative Products .....	122
C.22 Drainage Facilities .....	123
C.22.1 Baseline Storm Water Drainage Facilities Inspection and Cleaning.....	124
C.22.2 Enhanced Storm Drain Inlet Inspection and Cleaning Program.....	126
C.22.3 Illegal Connection and Illicit Discharge Detection and Elimination (IC/ID) .....	127
C.22.4 Illegal Spill Discharge Control.....	130
C.23 Structural Treatment System Maintenance.....	131
C.23.1 Biofiltration Strips and Swales .....	133
C.23.2 Infiltration Basins .....	137
C.23.3 Infiltration Trenches .....	140
C.23.4 Detention Devices .....	143
C.23.5 Traction Sand Trap Devices.....	147
C.23.6 Gross Solids Removal Devices .....	150
C.23.7 Austin Media Filters .....	156
C.23.8 Delaware Sand Filters .....	159
C.23.9. Multi-Chambered Treatment Train (MCTT) .....	162
C.23.10 Wet Basin .....	165
C.23.11 Design Pollution Prevention (DPP) Infiltration Areas .....	169
C.23.12 Bioretention.....	173
C.23.13 Open Graded Friction Course (OGFC) .....	177
C.24 Litter and Debris Removal .....	179

C.24.1 Litter and Debris .....	180
C.24.2 Anti-Litter Signs .....	181
C.25 Chemical Vegetation Control .....	182
C.26 Slopes Prone to Erosion and Sediment Discharge .....	183
C.27 Snow Removal and De-Icing Agents .....	185
C.28 Stormwater Dewatering Operations (Temporary Pumping Operations) .....	187
C.29 Sweeping and Vacuuming .....	189
C.30 Maintenance Facility Housekeeping Practices .....	191

## C.1 Maintenance BMPs

Caltrans performs a variety of maintenance activities on highways throughout California to maintain a safe and usable condition for the motoring public. In contrast to construction projects, maintenance activities are performed by a small crew for a short duration (most activities are completed within one day) and minimal soil disturbance (generally less than one acre). Appendix C of the Maintenance Staff Guide describes the stormwater pollution prevention BMPs that are used at Maintenance facility operations and during highway activities. Maintenance activity sites are located along the state's highways and rights-of-way. The practices described in this section may be used for purposes other than stormwater pollution prevention, but those uses are not described in this Appendix.

This section describes those BMPs to be considered during maintenance activities. These BMPs shall be considered for implementation on an activity-by-activity basis. The BMPs in this section represent deliberate implementation, as differentiated from natural terrain features such as mounds, vegetation or depressions that may indirectly function to control runoff. Caltrans Maintenance Managers provide supervision to the Maintenance Superintendents who ensure the maintenance BMPs are implemented within their jurisdictions. Maintenance Supervisors have on-site responsibility for BMP implementation and maintenance.

Where BMPs listed in this Appendix are found to be inadequate in meeting site-specific needs, Section 2.5 of this Maintenance Staff Guide provides a feedback process to modify and improve BMP effectiveness. Section 4 of the SWMP encourages the Department to use innovative approaches to implementing BMPs presented in the SWMP and implementing new BMPs not yet addressed in the SWMP. Adoption of new BMPs is subject to the evaluation of the SWATS and approval by the Division Chiefs.

The terms “may, should and shall” are used throughout this document. These terms are used consistently with other Caltrans maintenance guidance documents. They are defined as follows:

- **May:** Maintenance staff has the flexibility to use or not use the guidance provided based on their best professional judgment.
- **Should:** Maintenance staff will follow the guidance provided unless there is a strong justification for doing otherwise. Maintenance staff needs to document the justification for not implementing a BMP.
- **Shall:** Maintenance staff must follow the provided guidance.

## C.2 Maintenance Activity Table

This summary matrix table is to identify all the approved Maintenance BMPs that may be applicable for each Caltrans maintenance operation and activity. Personnel performing maintenance activities can determine which BMPs should be applied for each activity by consulting this table.

To use this table, select the column of the maintenance activity to be performed at the top of the matrix table and identify the maintenance BMPs in the left rows that are marked for implementation.

For some activities, maintenance personnel may select from a variety of BMPs for stormwater pollution prevention. For example, during cleanup or repair of minor slides and slip-outs, several sediment controls are available that may adequately contain sediment. Personnel will need to select one or a combination of the available control methods to address the sediment they encounter at the site. Also, individual BMPs identified on the tables will not necessarily be applicable to all works involving the activity. For example, not all sites will have on-site fueling operations, but those that do should be required to perform those operations in a manner consistent with the intent of the BMP descriptions that follow this matrix table.

THIS PAGE INTENTIONALLY LEFT BLANK















## C.3 Scheduling and Planning

### Description:

This BMP provides recommended planning and scheduling implementation procedures for maintenance activities to minimize and/or eliminate potential water quality impacts. This BMP incorporates scheduling and planning of activities (at maintenance facilities or maintenance activity sites) in a manner that considers the use of all appropriate Division of Maintenance BMPs.

Planning is needed to reduce the exposure of potential pollutants to wind, rain, runoff and vehicle tracking and is important when working in the vicinity of a drainage system or water body. The Division of Maintenance has developed the following maps and databases to assist in scheduling appropriate activities, such as storm drain inspection and cleaning, erosion control and slope stabilization, to increase their water quality benefit:

- District maps and databases which delineate Environmentally Sensitive Areas (ESAs) on the California State Highway System. ESA's include such areas as CWA 303d listed water bodies, ASBS and endangered species habitat.
- District maps and databases which delineate Areas Prone to Erosion on the California State Highway System. The Division of Maintenance has defined areas prone to erosion on the California State Highway System as route segments requiring major and/or minor erosion repair activities for three consecutive years.
- Areas on the California State Highway System. These are route segments with special significance in the scheduling of erosion control activities and storm drain inlet inspections and cleanings.

Hard copies of the information may be requested from the Headquarters Division of Maintenance Office of Roadside or electronic files downloaded from the Division of Maintenance Stormwater website at the following address: <http://onramp.dot.ca.gov/hq/maint/OMSWEC/Stormwater.shtml>

### Appropriate Applications:

Implementing proper scheduling and planning for all Maintenance operations to minimize erosion and the potential to discharge pollutants to stormwater are the very first steps in an effective stormwater program. Maintenance activities should be scheduled to minimize land disturbance and/or sediment transport during the wetter months October through May.

Except for emergency conditions, the following activities shall not be performed during rain events or when storms are predicted:

- Asphalt cement crack and joint grinding/sealing;
- Asphalt paving;
- Structural pavement failure (digouts) pavement grinding and paving;
- Sealing operations;
- Portland cement crack and joint sealing;
- Mudjacking and drilling;
- Shoulder grading (should not be performed if runoff is visible);
- Non-landscaped chemical vegetation control;
- Curb and sidewalk repair;
- Chemical vegetation control (not pre-emergent);
- Painting;



- Thermoplastic striping and marking;
- Paint striping and marking;
- Raised/recessed pavement marker application and removal; and
- Outdoor vehicle and equipment maintenance and repair.

### General Implementation:

- During the wetter months and prior to forecast storm events, avoid scheduling maintenance activities that could adversely affect stormwater quality.
- Planning should include a review of appropriate BMPs specific to an activity to ensure that proper procedures are implemented and that all materials necessary are brought to the activity site.
- Planning should include a tailgate meeting for the specific activity if needed.
- Ensure ample supply of BMP materials are on site in order to quickly mobilize and implement required BMPs.
- If trenching will take place, sequence trenching activities so that most open portions are closed before new trenching begins. Trenched material should be stored on the upstream side of the trenches.

### Additional EPA Administrative Order Implementation:

The Environmental Protection Agency Findings of Violation and Order for Compliance Docket No. CWA-09-2011-0001 (EPA Order) Section III.B.4 requires the Caltrans to:

- Develop a maintenance schedule for storm drain inlets that pose a significant threat to water quality based on, among other factors, the CWA 303(d) list of impaired water bodies for pollutants likely to be discharged from Caltrans facilities and rights-of-way, applicable TMDLs, and known "hot spot" areas for pollutant accumulation as identified by Maintenance personnel, complainants, and others.

Develop an inventory of road segments prone to erosion and the discharge of sediment. Caltrans shall include a schedule for the stabilization of erosion prone slopes with priority given first to slopes discharging to water bodies on the CWA 303(d) list or where other data shows that water quality standards are not being met.

To meet the EPA Order, the following General Implementation actions were added:

Maintenance Supervisors in determining the schedule for drain inspection cleaning, and the stabilization of erosion prone slopes activities shall prioritize their work order scheduling found in Sections C.22.1 Baseline Stormwater Drainage Facilities, Inspection and Cleaning, and C.26 Slopes Prone to Erosion and Sediment Discharge. District maps and databases defining route limits have been developed to assist in the implementation of this mandated BMP.

This BMP is not intended to supersede actions required by a Maintenance Supervisor in determining activity priority required for public safety or transportation system preservation.

## C.4 Sediment Control

Sediment control includes those practices that intercept, slow or detain the flow of stormwater and allow sediment to settle and be trapped. These practices can consist of installing linear sediment barriers

C.4.1 Silt Fence

C.4.2 Sandbag or Gravel Bag Barriers

C.4.3 Straw Bale Barriers

C.4.4 Fiber Rolls

C.4.5 Check Dams

C.4.6 Sediment Trap BMP

C.4.7 Weighted Fiber Rolls

C.4.8 Compost Sock

C.4.9 Flexible Sediment barrier

Sediment barriers are typically placed below the toe of exposed and/or erodible slopes, downslope of exposed soil areas, at stockpile sites, and at other appropriate locations along the perimeter of disturbed soil areas. All sediment barriers require periodic inspection and maintenance. Weighted Fiber Rolls may replace conventional fiber rolls when used on paved surfaces.

### C.4.1 Silt Fence



Figure C-4.1. Silt Fence for Stockpile Perimeter Control

#### Description:

A silt fence is a linear sediment barrier of permeable fabric designed to intercept and slow the flow of sediment-laden sheet flow runoff. Silt fences allow sediment to settle from runoff before water leaves a disturbed soil area. Silt fences are more difficult to install and maintain than most other sediment control options. This limits their use for short-term maintenance activities.

#### Appropriate Applications:

- Silt fences may be used for temporary stockpiles.
- For cleanup/repair of minor slides and slipouts, silt fences may be placed below the toe of exposed and erodible slopes or downslope of exposed soil areas to address long-term erosion concerns.
- Silt fences may be used as a temporary measure during roadside stabilization activities.
- Silt fences may also be considered when performing work in the vicinity of sensitive water bodies.
- Silt fences cannot be used under extremely muddy or rocky conditions where the fence cannot be properly trenched and keyed in.
- Do not install silt fence across intermittent or permanent streams, channels, or any location where concentrated flow is anticipated.
- Silt fence filter fabric deteriorates faster when used in open, windy areas.
- Generally, silt fences should be used in conjunction with soil stabilization source controls up slope to provide effective erosion and sediment control.

#### Implementation:

- Silt fences should be constructed with a setback of at least 3 feet from the toe of a slope or stockpile. Where a silt fence cannot have a 3 feet setback due to specific site conditions, the silt fence may be constructed as far from the toe of the slope as practicable.
- A conceptual silt fence is shown in Figure C.4.1-2 and C.4.1-3. The notes on the figure provide guidance for the proper installation of silt fences.

- Fence posts shall be spaced at 5 to 6 feet intervals and shall be positioned on downstream side of fence.
- Silt fence should be placed on level contour. If placement on contour is not possible, cross barriers (Figure C.4.1-2 and C.4.1-3) are necessary.

### Maintenance:

- Inspect silt fences routinely to ensure they are functioning properly.
- Repair undercut silt fences.
- Repair or replace split, torn, slumping or weathered fabric.
- Remove sediment prior to accumulation reaching one-third of the fence height. Consideration should be given to incorporating removed sediment into the maintenance activity site.
- Remove a silt fence when it is no longer needed. Fill postholes and anchorage trench and remove sediment accumulation to conform to existing grade.
- Maintain silt fences to provide an adequate sediment holding capacity. Sediment should be removed when the sediment accumulation reaches one-third of the barrier height.

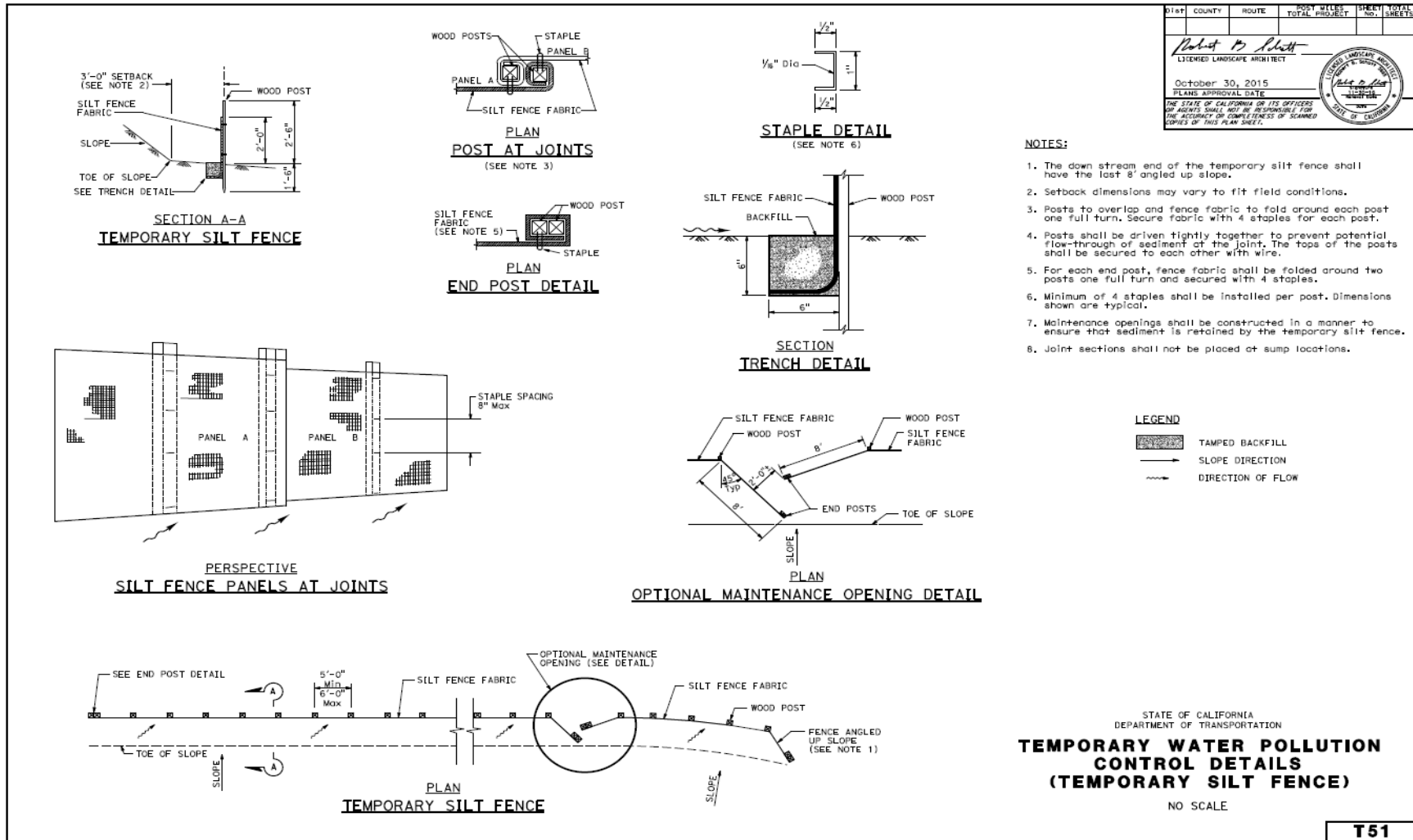

Figure C.4.1-2. Temporary Linear Sediment Barrier (Silt Fence)

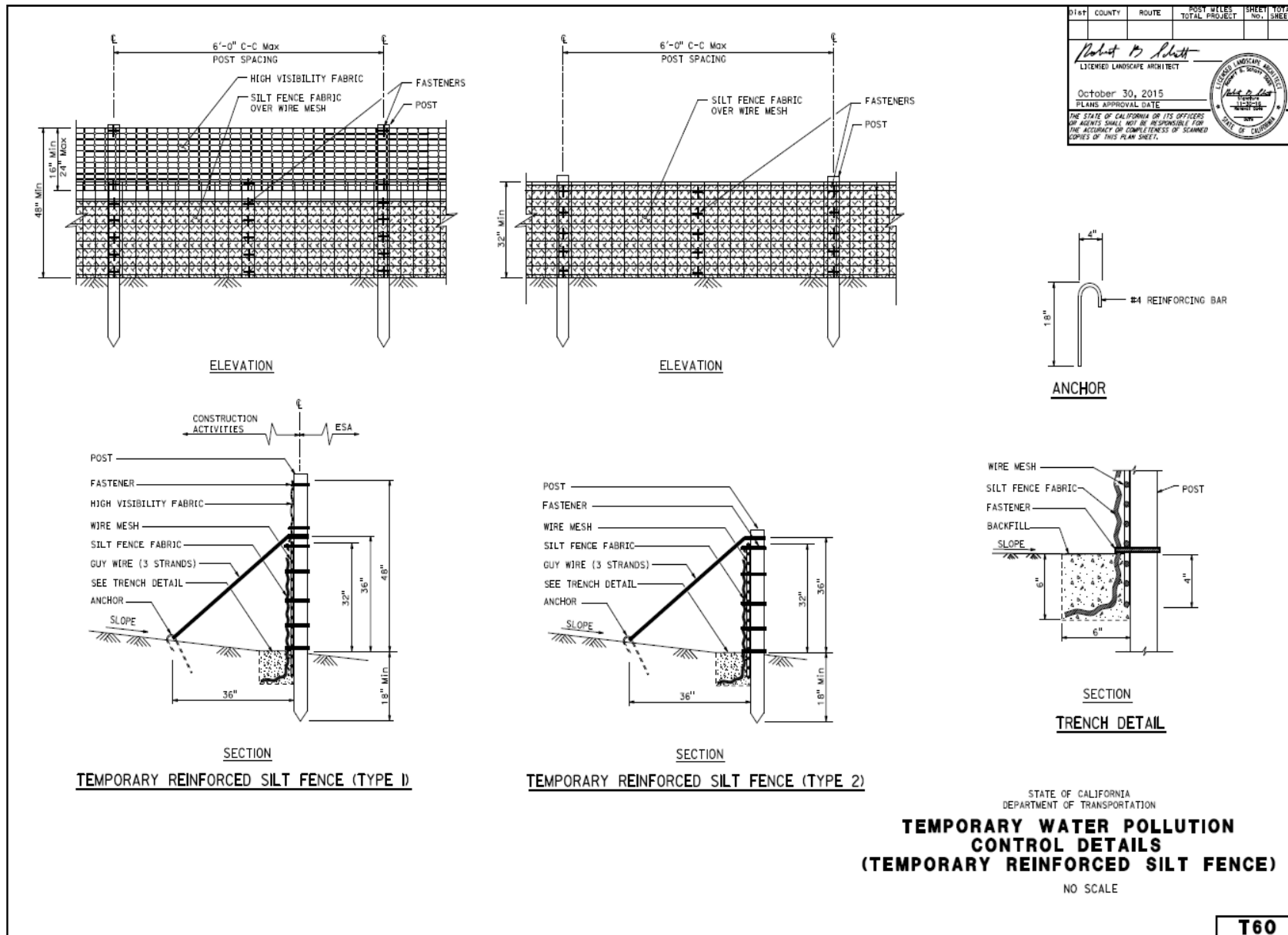

Figure C.4.1-3. Temporary Linear Sediment Barrier (Reinforced Silt Fence)

### C.4.2 Sandbag or Gravel Bag Barrier



Figure C.4.2-1 Gravel bag Barrier

#### Description:

A sandbag or gravel bag barrier is a linear sediment barrier consisting of stacked sand- or gravel-filled bags designed to intercept and slow the flow of sediment-laden sheet flow runoff. Sandbag and gravel bag barriers allow sediment to settle from runoff before water leaves a disturbed soil area. Sandbag or gravel bag barriers may also be used to divert the flow of water (see C.3.2 Ditches, Berms, Dikes and Swales BMP). Gravel bag barriers are generally preferred because the gravel is easier to contain if the bag fails and should be used in all areas where traffic is anticipated. If there is no ponding area, sandbags should not be used since they could increase potential for ponding as they are slow-filtering devices.

#### Appropriate Applications:

- Sandbag and gravel bag barriers are temporary measures used to divert water and intercept sediment. They may be used during Drain and Culvert Maintenance, Drainage Ditch and Channel Maintenance, Irrigation Line Repairs, Roadside Stabilization, Sandblasting, Wet Blast with Sand Injection and Hydroblasting, Minor Slides and Slipouts Cleanup/Repair and Building and Grounds Maintenance. Other BMPs are preferred if the barrier is required for more than a few months.
- Sandbag and gravel bag barriers should be placed below the toe of slopes with exposed and erodible soil.
- Sandbag or gravel bag barriers may be placed around stockpiles at maintenance activity sites or maintenance facilities. It may be used to weigh down on fiber rolls installed around stockpiles located on flat paved surfaces. at three feet interval provided no gap exists for sediment or residuals to pass under the fiber rolls.
- They may also be used to protect drain inlets and ditch lines during maintenance activities at maintenance activity sites or maintenance facilities (see C.5 Storm Drain Inlet Protection BMP).
- Due to their density, sandbags are preferable to divert flows or to prevent flows from entering a stormwater conveyance system or watercourse. Gravel bags are better suited for filtration purposes.



- Sandbag materials are sensitive to ultraviolet light resulting in a limited durability that may make them unsuitable for long-term activities. Sandbag barriers are labor intensive. Installation, removal, and maintenance costs should be evaluated when considering this BMP.
- Use permeable gravel bags as appropriate for settling and filtering sediment in ditch lines that only receive road runoff (low flow). Gravel placed in the permeable bags needs to be washed gravel or rock so that there are no fines in the material.

### Implementation:

- Sandbag or gravel bag materials:
  - Bag material should be canvas, polypropylene, polyethylene, burlap or polyamide woven fabric. Sand bags should be made of non-permeable or low permeability material while gravel bags should be made of permeable material.
  - Fill material should consist of clean coarse sand or gravel.
  - Fill material shall be ½ to 1-inch class 2 aggregate base that is clean and free from clay and deleterious materials.
  - For permeable gravel bags, gravel size shall be between ¾ inch and 1 inch.
- Details of a temporary linear sandbag barrier are shown in Figure C.4.2-2. Notes on the figure provide guidance for implementation.

### Maintenance:

- Inspect sandbags and gravel bags to ensure the sediment barrier is functioning properly.
- Reshape or replace sandbags and gravel bags as needed.
- Repair washouts or other damage as needed.
- Remove sandbags and gravel bags when no longer needed. Remove sediment accumulation when it reaches one-third of the barrier height, clean the maintenance activity site of debris, regrade if necessary and stabilize the area.

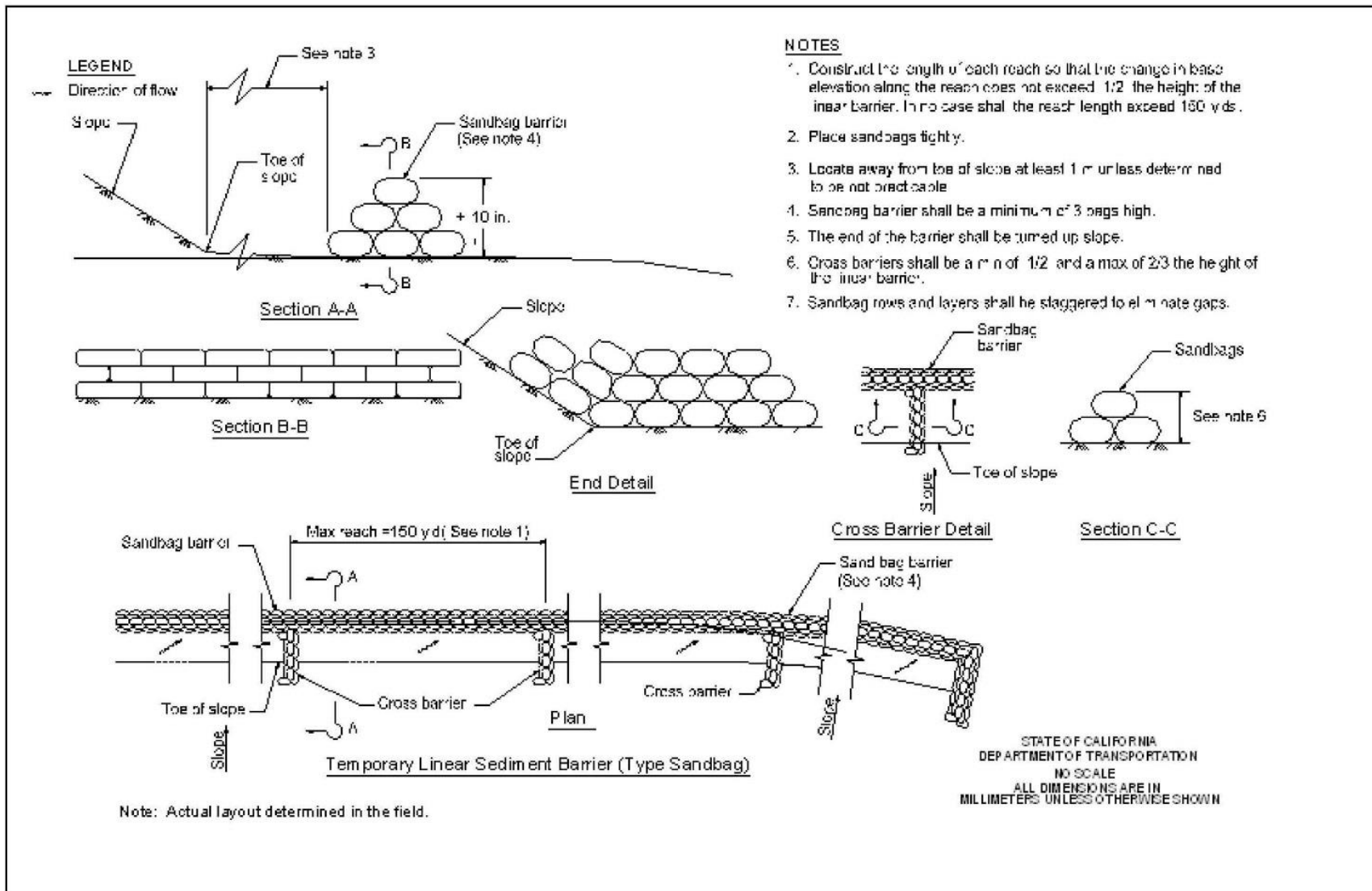

Figure C.4.2-2 Temporary Linear Sediment Barrier (Sandbag)

THIS PAGE INTENTIONALLY LEFT BLANK

### C.4.3 Straw Bale Barrier



Figure C.4.3-1. Straw Bale Barrier to Control Sheet Flow Runoff

#### Description:

A straw bale barrier is a linear sediment barrier consisting of straw bales designed to intercept and slow the flow of sediment-laden sheet flow runoff. Straw bale barriers allow sediment to settle from runoff before it leaves a disturbed soil area. Straw bale barriers are readily available and suitable for many short-term applications in maintenance activities. Straw bale barriers have the disadvantages of being bulky and heavy when wet.

#### Appropriate Applications:

- Straw bale barriers are best suited for short-term applications. and should not be placed in areas receiving concentrated flow.
- Straw bale barriers are typically placed below the toe of exposed and erodible slopes, downslope of disturbed soil areas (e.g., Minor Slides and Slipouts Cleanup/Repair).
- Straw bale barriers may be placed around stockpiles at maintenance activity sites or at maintenance facilities. Straw bales need to be trenched and therefore not applicable for paved roads.
- Straw bales should not be used for drain inlet protection. Straw bale barriers should be considered impermeable. Very little water flows through the bales. Water will flow around or under them often causing erosion. Proper installation is required to prevent undermining.

#### Implementation:

- Details of a temporary straw bale barrier is shown in Figure C.4.3-2. The notes on the figure are useful guidance for the placement and trenching and keyed in of larger barriers.
- Secure each straw bale with 2 posts. The first post in each bale must be driven toward the previously laid bale to force the bales together. Drive the posts into the soil such that the top of the post is less than 2 inches above the top of the straw bale. The post must extend a minimum of 2 feet in the ground below the bottom of the straw bales.

**Maintenance:**

- Degraded straw bales may fall apart when removed or left in place for extended periods. Repair washouts or replace damaged straw bales as needed.
- Remove straw bales when no longer needed. Inspect straw bales for sediment accumulations and remove sediment when depth it reaches one-third the barrier height,

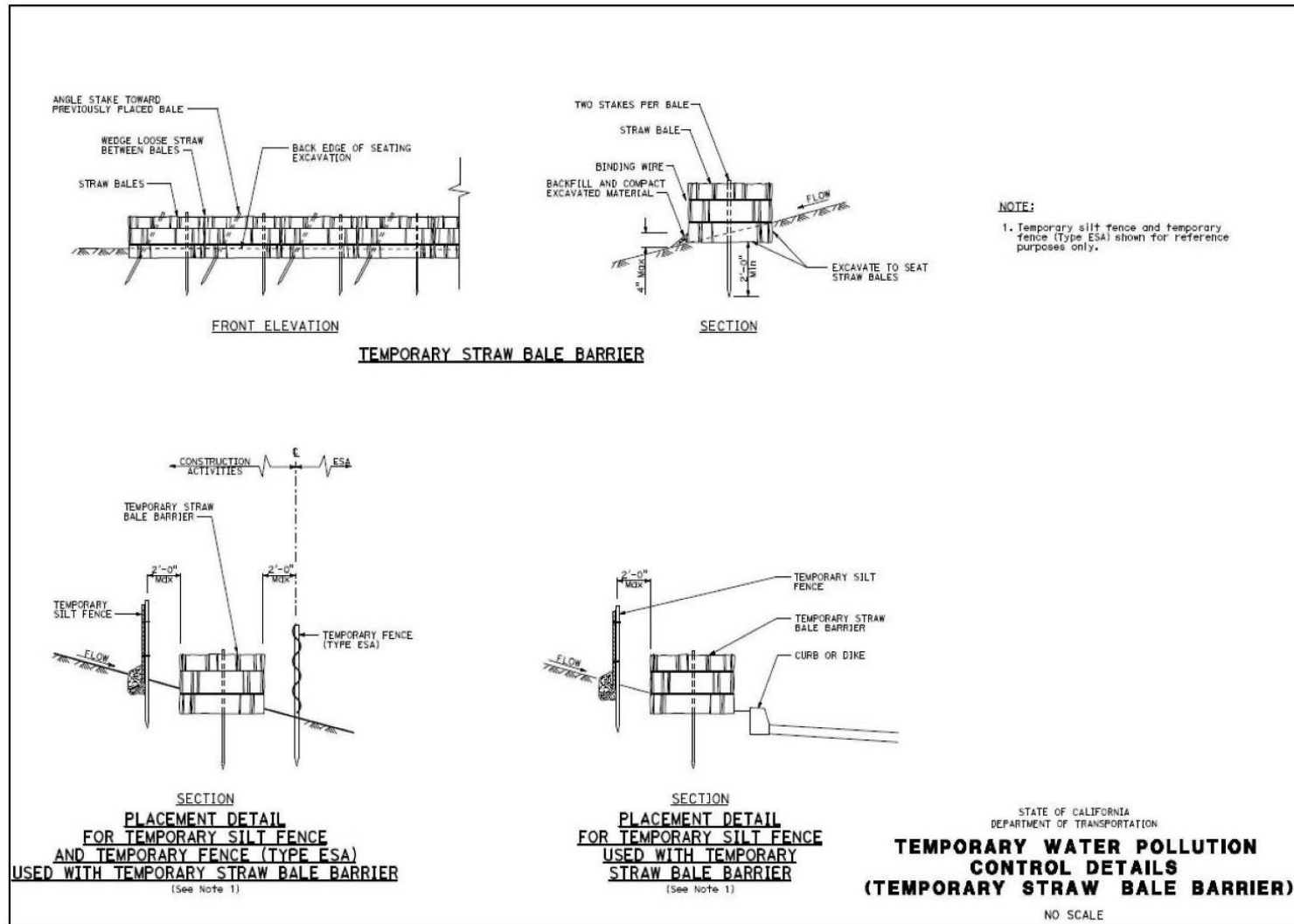

Figure C.4.3-2. Temporary Linear Sediment Barrier (Straw Bale)

### C.4.4 Fiber Rolls



Figure C.4.4-1 Fiber Rolls used to break slope length

#### Description:

A fiber roll consists of wood excelsior, rice or wheat straw, or coconut fibers that is rolled or bound into a tight tubular roll and placed on the toe and face of slopes to intercept runoff, reduce its flow velocity, release the runoff as sheet flow and provide some removal of sediment from the runoff. Fiber rolls are preferred at activity sites where the fiber rolls may be left in place for assimilation into the site provided it is made of biodegradable netting. Fiber rolls with plastic netting, sometimes described as 'photodegradable', are not permissible for permanent or long-term temporary installations, or near Environmentally Sensitive Areas (ESAs). Fiber rolls are available commercially in diameters between 8 inches and 20 inches.

#### Appropriate Applications:

- Fiber rolls may be used for minor slides and slipouts cleanup/repair.
- Fiber rolls may be used along the face and at grade breaks of exposed and erodible slopes to shorten slope length and spread runoff as sheet flow.
- Fiber rolls may also be used for inlet protection and as check dams under certain situations.
- Fiber rolls may be used around temporary stockpiles.

#### Implementation:

- Fiber roll materials are either:
  - Prefabricated rolls; or
  - Rolled tubes of erosion control blanket.
- Assembly of field-rolled fiber roll:
  - Roll length of erosion control blanket into a tube.
  - Bind roll at each end (may be bound along length of roll with jute-type twine).



### Installation:

- Install fiber rolls on level contours in a shallow trench.
- Longer or additional stakes are needed where snow will accumulate behind roll. Drifting snow tends to pull rolls downhill.
- For type-1 installation, place roll in shallow trench (2 to 4 inches deep). For type-2 installation, trenching is not necessary.
- Stake fiber rolls securely with maximum stake spacing of 4 feet through the center of roll for type-1 installation or every 2 feet on alternating sides of the roll for type-2 installation. Check to be sure the ground will hold stakes tight.
  - Maintenance procedure is to secure adjacent rolls with a one foot overlap. A roll may be placed behind the adjacent roll and tied but not on top.
  - Installation interval varies with the steepness of the slope:
    - Slope inclination of 1:4 or flatter: fiber rolls shall be placed on slopes 20 feet apart.
    - Slope inclination of 1:4 to 1:2: fiber rolls shall be placed on slopes 15 feet apart.
    - Slope inclination 1:2 or greater: fiber rolls shall be placed on slopes 10 feet apart.
- Details of fiber roll installation are shown in Figure C.4.4-2 and C.4.4-3. The notes on the figure are useful guidance for the installation of fiber rolls.
- Fiber rolls are typically left in place.
- If fiber rolls are removed, collect and dispose of sediment accumulation, and fill and compact holes, trenches, depressions or any other ground disturbance to blend with adjacent ground.
- Where fiber rolls are installed on paved surfaces, gravel bag weights shall be placed on top at three-foot intervals or weighted fiber rolls used. Ensure fiber rolls fit tightly against the pavement and any concrete wall or edge to prevent gaps.

### Maintenance:

- Replace or repair split, torn, unraveling or slumping fiber rolls.
- Replace broken or split wood stakes.
- Inspect fiber rolls when there is a forecast of rain. Inspect fiber rolls following rainfall events and at least daily during prolonged rainfall. Perform maintenance as needed.
- Repair or adjust the fiber roll if rills or other evidence of concentrated runoff occur beneath the fiber roll.
- Maintain fiber rolls to provide an adequate sediment holding capacity. Sediment shall be removed when the sediment accumulation reaches one-third of the barrier height.

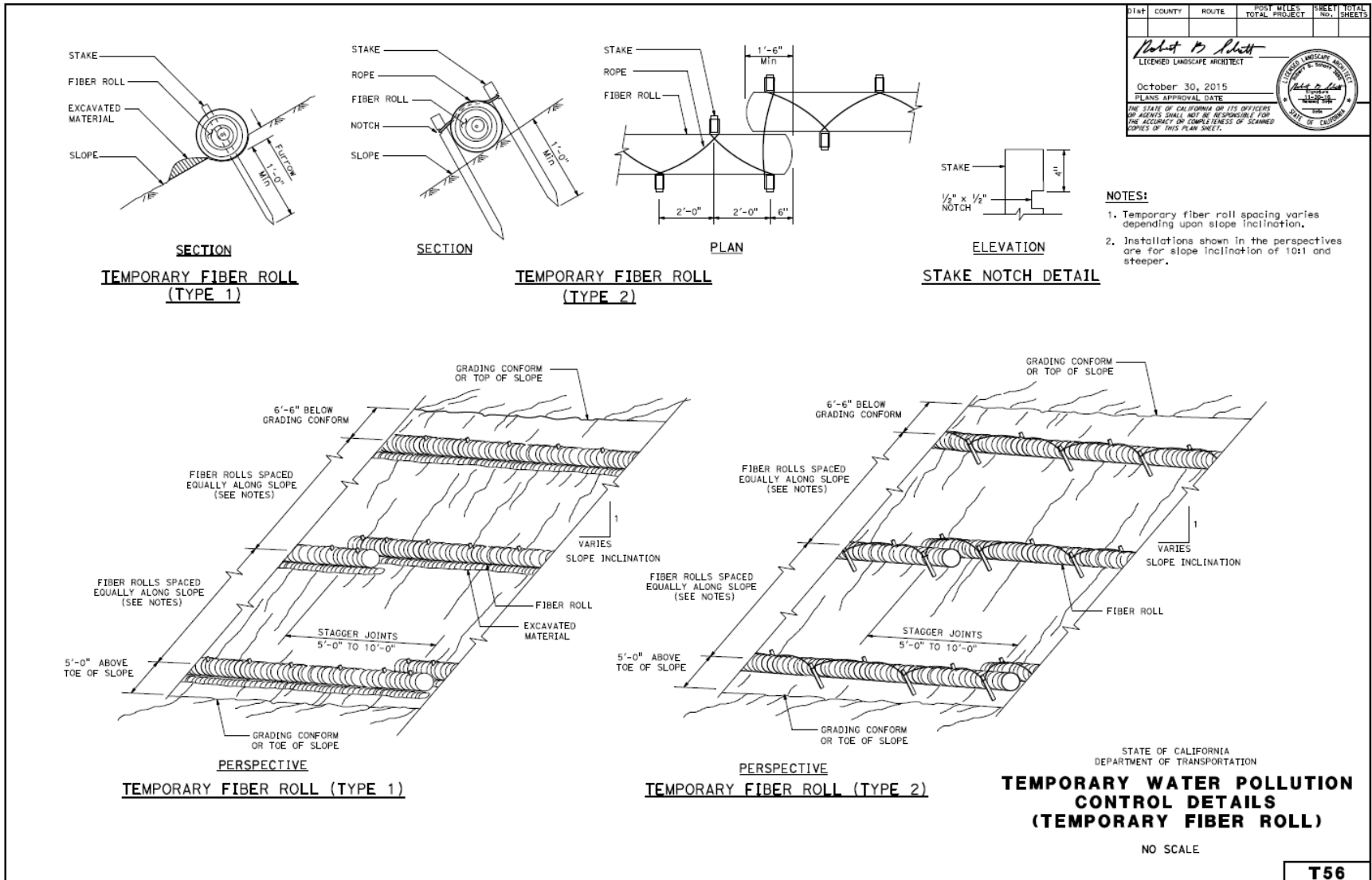

Figure C.4.4-2. Fiber Roll

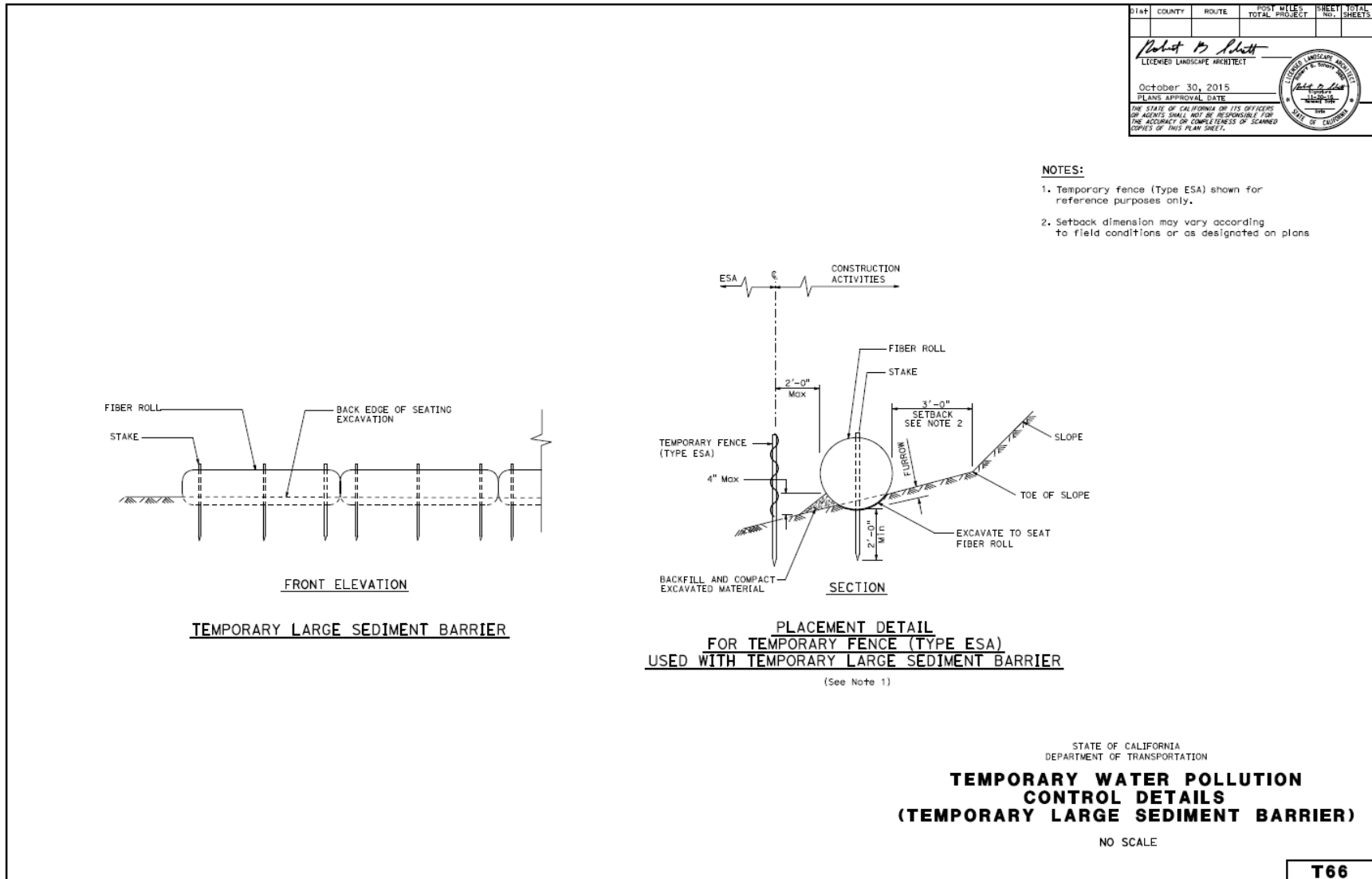

Figure C.4.4-3. Fiber Roll (Large)

### C.4.5 Check Dam



Figure C.4.5-1 Check Dam

#### Description:

A check dam is a small, temporary device constructed of rock, fiber rolls, gravel bags or sandbags placed across a natural or man-made channel or drainage ditch. If rock is the chosen material, it should be clean and uniform graded smaller than 8" to 12" diameter. Restricting the flow velocity in the ditch line reduces erosion of the drainage ditch. Check dams can be installed to slow and filter stormwater runoff (rock or permeable gravel bags, sand bags, fiber rolls).

#### Appropriate Applications:

- Check dams shall not be installed in watercourses without required regulatory permits.
- Check dams are primarily considered for use during emergency situations (Minor Slides and Slipouts Cleanup/Repair).
- Check dams may be used when working in areas receiving concentrated flow (see C.9 Clear-Water Diversion BMP).
- Check dams may be installed in small open or steep channels.

#### Implementation:

- Check dams should be placed at a distance and height to allow small pools to form behind them. They should follow up the side contours to reduce/eliminate scour.
- Details of a rock, fiber roll, and gravel bag temporary check dam are shown in Figure C-9. The notes on the figure provide guidance for the implementation of check dams.

#### Maintenance:

- Remove sediment prior to accumulation reaching one-third of the check dam height.
- Remove the check dam when no longer needed.
- Frequent maintenance is needed to prevent re-suspension of accumulated sediment.

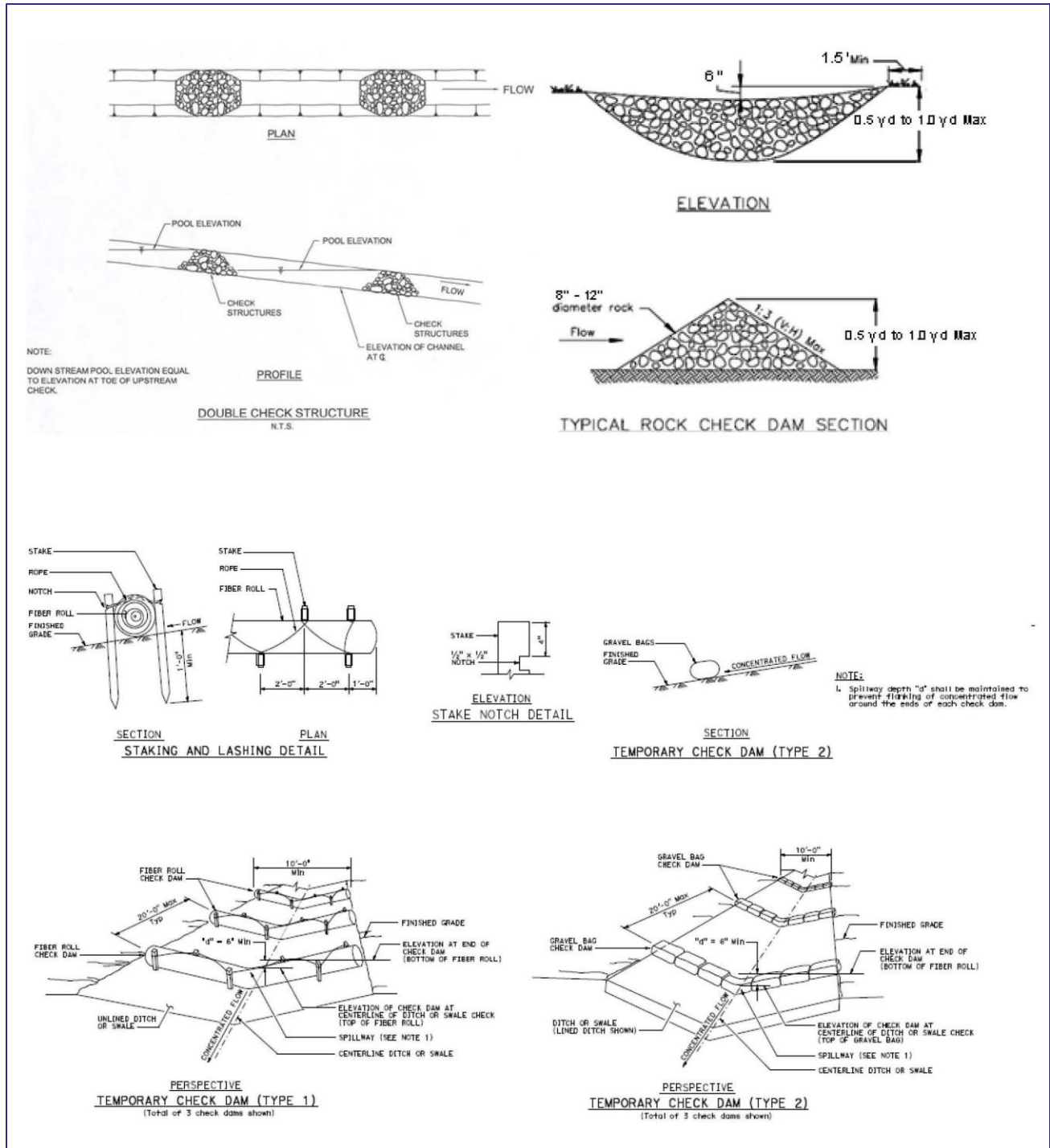

Figure C-4.5-2. Temporary Check Dam



### C.4.6 Sediment Trap



Figure C.4.6-1 Sediment Trap

#### Description:

A sediment trap is a basin formed by excavating or constructing an earthen embankment across a ditch line or low drainage area.

#### Appropriate Applications:

- Sediment traps may be used where the contributing drainage area is less than 5 acres. Traps should be placed to divert sediment-laden stormwater may enter a stormwater drainage system or watercourse.
- Sediment traps may be used for Minor slides and slipouts cleanup repair.
- Sediment traps shall not to be located in waterways.
- Sediment traps only removes large and medium sized particles and requires upstream erosion control and require extensive inspection and maintenance

#### Implementation:

- Traps should be situated according to the following criteria: (1) by excavating a suitable area, such as a low embankment constructed across a swale; (2) where failure would not cause loss of life or property damage; and (3) to provide access for maintenance, including sediment removal and temporary storage of sediment in a protected area.
- Sediment traps should be adequately sized to allow settling of sediment.
- Trap inlets should be located to maximize the travel distance to the trap outlet. Rock or vegetation may be used to protect the trap outlets against erosion (see C.7.8 Riprap [Rock Slope Protection] BMP).
- To dewater the trap, the outlet may be constructed in one of the following ways: (1) use a small diameter riser pipe with dewatering holes encased in gravel; (2) construct a crushed stone outlet section of the embankment at the low point of the trap.

## Maintenance:

- Check sediment trap for groundwater seepage and embankment erosion.
- Check outlet structure and spillway for any damage or obstructions. Repair damages and remove obstructions as needed.
- Check outlet area for erosion and stabilize if required.
- Remove sediment prior to accumulating one-third the volume of the trap.
- If captured runoff has not completely infiltrated within 72 hours then dewatering the sediment trap might be required. The *Field Guide to Construction Site Dewatering* should be reviewed if the dewatering will be discharged off-site.
- Properly dispose of sediment and debris removed from the trap as follows:
  - Dispose of debris in accordance with C.13.2 Solid Waste Management BMP.



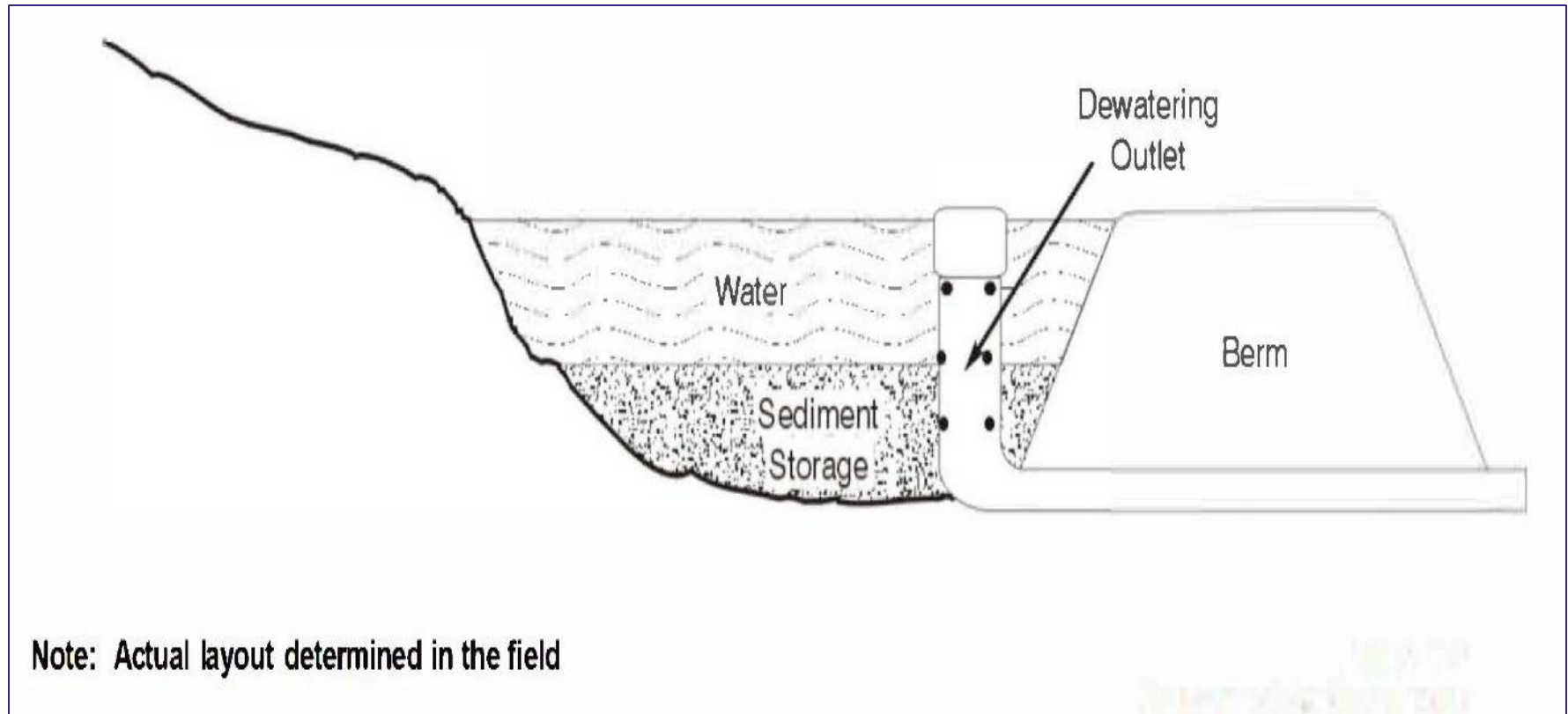

Figure C.4.6-2 Sediment Trap

### C.4.7 Weighted Fiber Rolls



Figure C.4.7-1 Fiber Rolls Used as Check Dams and for Drain Inlet Protection

#### Description:

A weighted fiber roll consists of crushed walnut shells, wood shavings/chips, or other natural materials that are rolled or bound into a tubular roll and netted in mesh, with handles at both ends for ease of handling. Weighted fiber rolls should weigh between four to eight pounds per linear foot. Weighted fiber rolls may replace straw fiber rolls, silt fences, straw bales, earth berms, willow fiber rolls, sand or gravel bags, and earth water- bars. Weighted fiber rolls filter stormwater runoff and trap sediment to prevent erosion by slowing and spreading water flow, thus diminishing stormwater runoff pollution. They provide long lasting sediment control along with filtering runoff water and can be cleaned and reused.

#### Appropriate Applications:

- Weighted fiber rolls may be used along the slope to prevent erosion by reducing slope length and slowing and spreading water flow and prevent rill and gully development.
- Weighted fiber rolls may be used along the edge of berms or sidewalks to keep soil in place and prevent it from washing out onto pavement or asphalt.
- Weighted fiber rolls may be used around drain inlets to slow water flow and capture soil and sediments to diminish runoff pollution.
- Weighted fiber rolls may be used as check dams to prevent rills and gullies from developing.
- Weighted fiber rolls may be placed around material stockpiles or storage areas to contain sediment.

#### Implementation:

- Installation:
  - Install weighted fiber rolls on a level contours end-to-end in shallow trench; there is no need to stake (the weight will keep it in place).
  - Install weighted fiber rolls along berms or sidewalks end-to-end. Multiple weighted fiber rolls can be used in series or placed downstream from each other. Overlap the ends by 1½ feet.

- Install weighted fiber rolls around drain inlet in a circle end-to-end or forming a “U” shape upstream of inlet
- Install on paved surfaces around stockpiles or material storage areas. Make sure no gaps exist where sediment may pass.

**Maintenance:**

Replace or repair split, torn, unraveling weighted fiber rolls

Weighted fiber rolls should be inspected for sediment accumulation that can render the weighted fiber roll ineffective.

### C.4.8 Compost Sock



Figure C.4.8-1 Compost sock with jute netting

#### Description:

Compost socks are a jute mesh sock containing compost that act as three dimensional, biodegradable structures that intercept and filter sheet flow. Compost socks can filter runoff, retain sediment, and reduce sheet flow velocities. Compost socks may be used as either a temporary or permanent sediment control measure.

#### Appropriate Applications:

- Compost socks may be used for minor slides and slipouts cleanup/repair.
- Compost socks may be used along the face and at grade breaks of exposed and erodible slopes to shorten slope length and spread runoff as sheet flow.
- Compost socks may also be used for inlet protection and as check dams under certain situations.
- Compost socks may be applied as both temporary and permanent sediment controls.

#### Implementation:

- Compost socks are installed in same manner as Fiber Rolls C.4.4.
- Compost socks consist of a 12-inch diameter mesh tube that is filled with compost. The mesh tube must be composed of a natural biodegradable product such as cotton, jute, sisal, burlap, or coir. The mesh tube must be clean, evenly woven, and free of encrusted concrete or other contaminating materials, cuts, tears, broken or missing yarns, and thin, open, or weak places.
- Compost socks must have a functional longevity of one year.

**Maintenance:**

- Inspect compost and remove sediment from behind the compost sock if sediment is 1/3 of compost sock height above ground.
- Repair or adjust the compost sock if rills or other evidence of concentrated runoff occur beneath the sock.
- Repair or replace compost socks if they become split, torn, or unraveled.
- Maintain compost socks to provide an adequate sediment holding capacity and runoff velocity reduction.

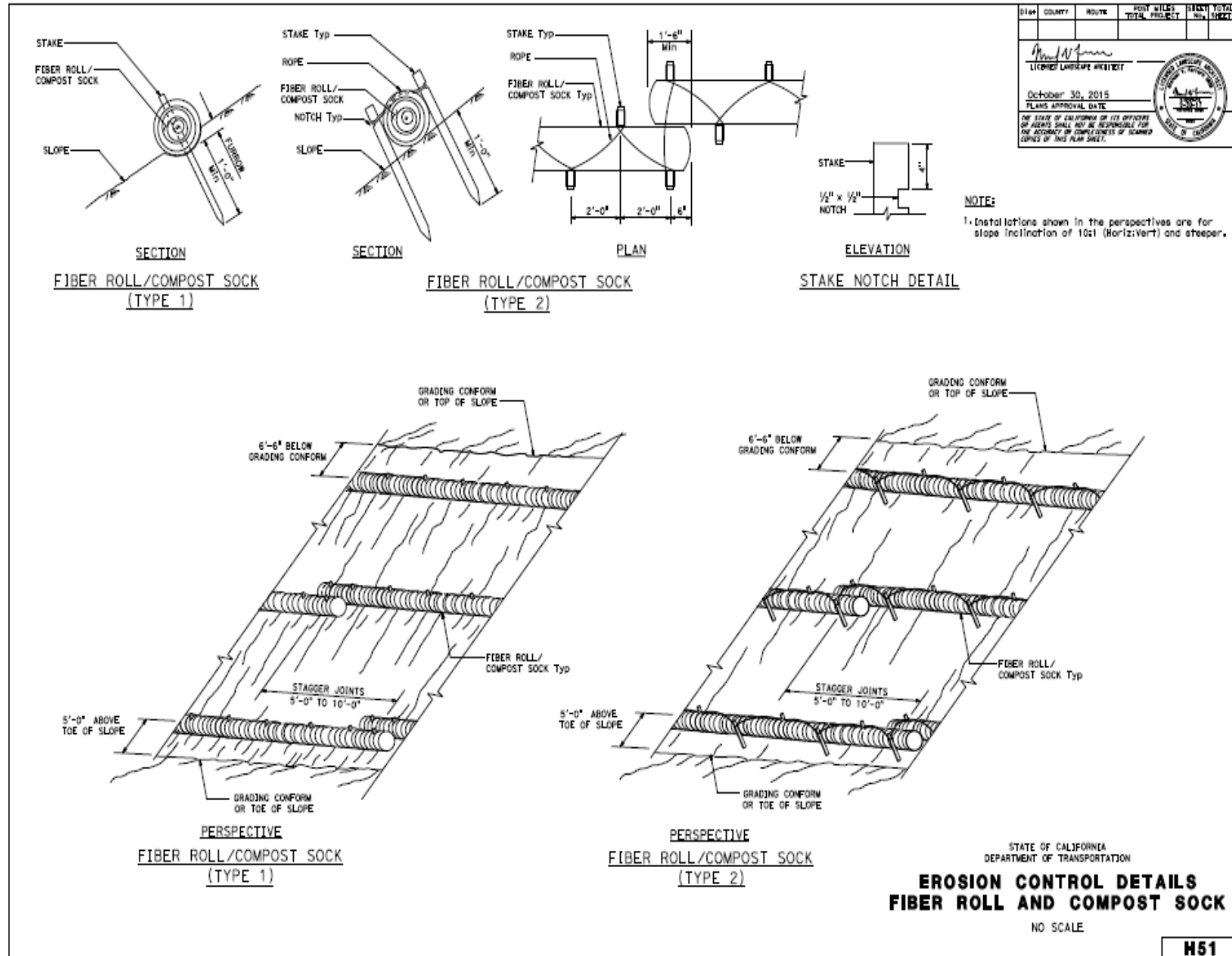

Figure C.4.8-2 Compost Sock



### C.4.9 Flexible Sediment Barrier



Figure C.4.9-1 Flexible Sediment Barrier

#### Description:

Flexible sediment barriers are synthetic alternatives to fiber rolls, compost socks, gravel or sand bag and straw bale barriers. Flexible sediment barriers consist of a geosynthetic fabric with a urethane foam-filled core and a fabric apron that helps to prevent undermining. These synthetic linear sediment barriers are generally more robust sediment controls than standard fiber rolls and may be appropriate for continuous use in stormwater collection areas.

#### Appropriate Applications:

- This BMP may be implemented during the following activities:
  - Flexible Pavement (A Family);
  - Rigid Pavement (B Family);
  - Slope/Drains/Vegetation (C Family);
  - Public Facilities (G Family);
  - Sawcutting for Loop Installation (K Family);
  - Minor Slides and Slipouts Cleanup/Repair (S Family);
  - Vehicle and Equipment Maintenance and Repair (if required in the field) (T Family); and
  - Aboveground and Underground Tank Leak and Spill Control (T Family).

#### Implementation:

- Remove obstructions, including rocks and debris greater than 1 inch from the ground.
- Secure flexible barrier to the pavement with 1-inch nails, and solvent-free adhesive or gravel billed bags.
- Secure flexible barrier to the soil with 6-inch nails



- Do not pierce the foam core of the barrier with nails.

### Maintenance:

- Inspect flexible sediment barrier before and after each rainfall event
- Maintain flexible sediment barriers to provide sediment-holding capacity and to reduce concentrated flow velocities.
- Repair or replace split, torn, or unraveled material.
- Add or replace posts, stakes or fasteners as needed to prevent sagging or slumping. adjust flexible sediment barriers.

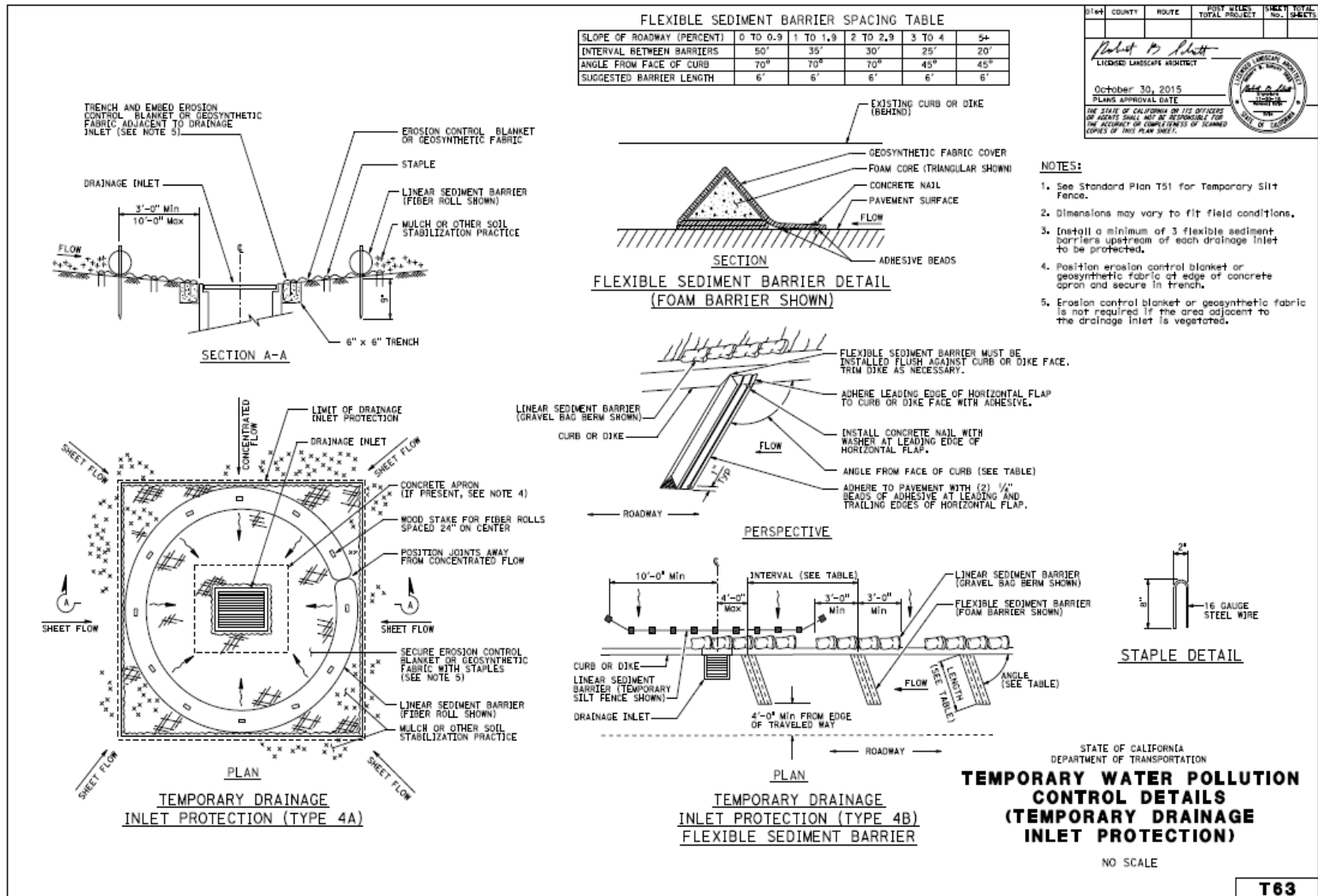

Figure C.4.9-2 Flexible Sediment Barrier

## C.5 Storm Drain Inlet Protection



Figure C.5-1 Storm Drain Inlet Protection

### Description:

This control practice is used in two ways: (1) to detain and/or to filter sediment-laden stormwater runoff and (2) to prevent unpermitted non-stormwater discharges into stormwater drainage systems or watercourses.

### Appropriate Applications:

- This BMP may be implemented during the following activities:
  - Flexible Pavement (A Family);
  - Rigid Pavement (B Family);
  - Slope/Drains/Vegetation (C Family);
  - Traction Sand Trap Devices (F Family);
  - Public Facilities (G Family);
  - Welding or Grinding (H Family);
  - Sawcutting for Loop Installation (K Family);
  - Paint Striping/Marking (M Family);
  - Minor Slides and Slipouts Cleanup/Repair (S Family);
  - Vehicle and Equipment Maintenance and Repair (if required in the field) (T Family); and
  - Aboveground and Underground Tank Leak and Spill Control (T Family).
- Storm drain inlet protection should be considered for activities where sediment-laden stormwater may enter a drain inlet.
- Use this BMP only where ponding of water will not encroach into highway traffic or onto erodible surfaces or slopes.

### Implementation:

- Impermeable covers should be used to prevent the unauthorized discharge of non- stormwater.
- Storm drain inlets may be temporarily covered with spill pads and/or mats during maintenance activities.
- Storm drain inlets may also be protected by surrounding an inlet with one or a combination of the following:
  - Silt fence (stormwater only);
  - Fiber rolls (stormwater only);
  - Straw bale barrier (stormwater only);
  - Polyurethane barrier (stormwater or non-stormwater);
  - Rubber barrier (stormwater or non-stormwater);
  - Sandbag or gravel bag barrier (gravel or aggregate preferred for stormwater only); or
  - Excavated culvert inlet sediment trap (stormwater only).

### Maintenance:

- Make sure silt fence stakes are securely driven into the ground and silt fence is trenched and keyed in. Replace damaged stakes.
- Repair fabric as needed. Replace or clean fabric prior to fabric becoming clogged with sediment.
- Check sandbags for proper installation. Replace damaged bags as needed.
- Remove all inlet protection when no longer needed.

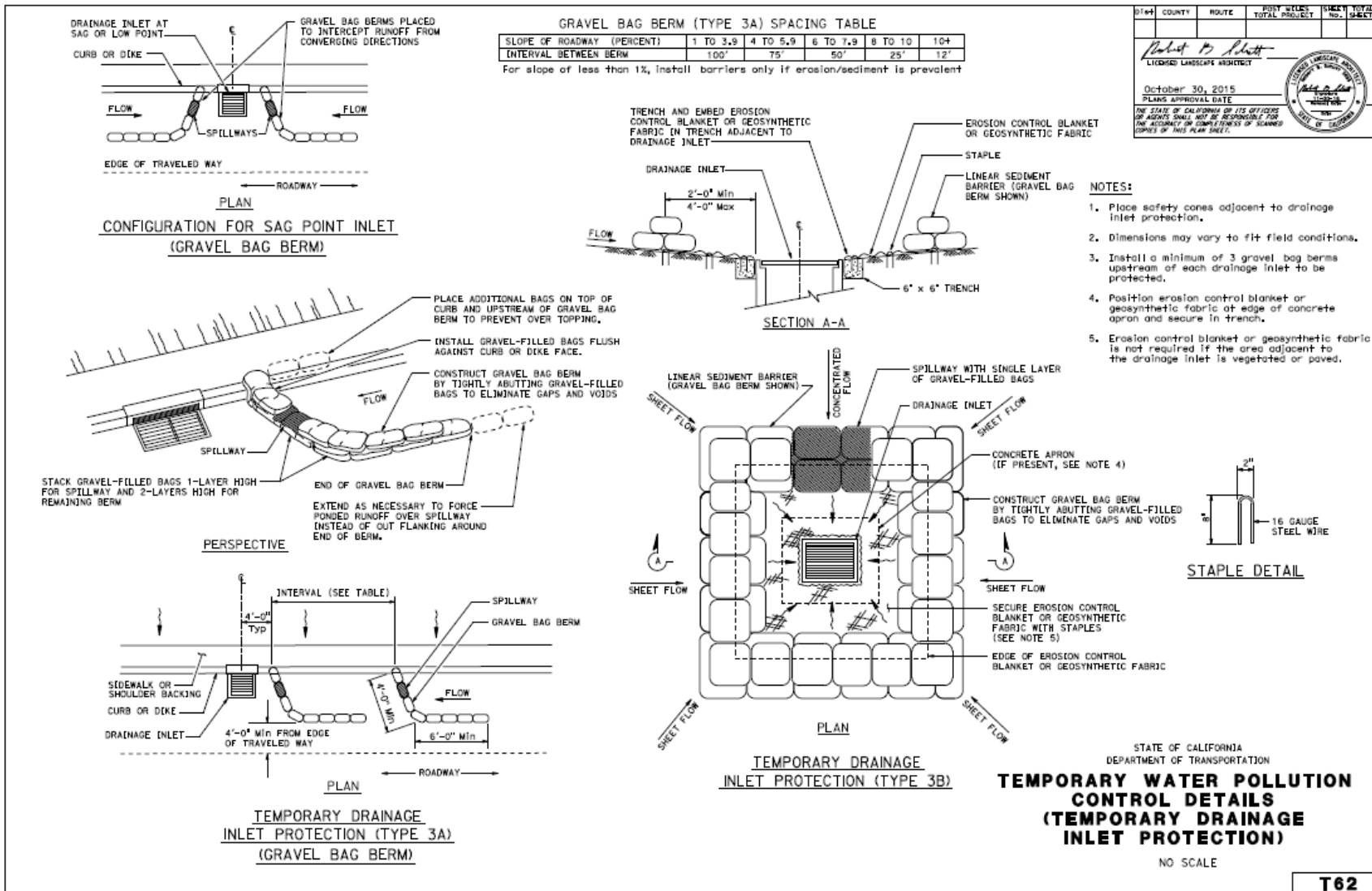

Figure C.5-2 Storm Drain Inlet Protection

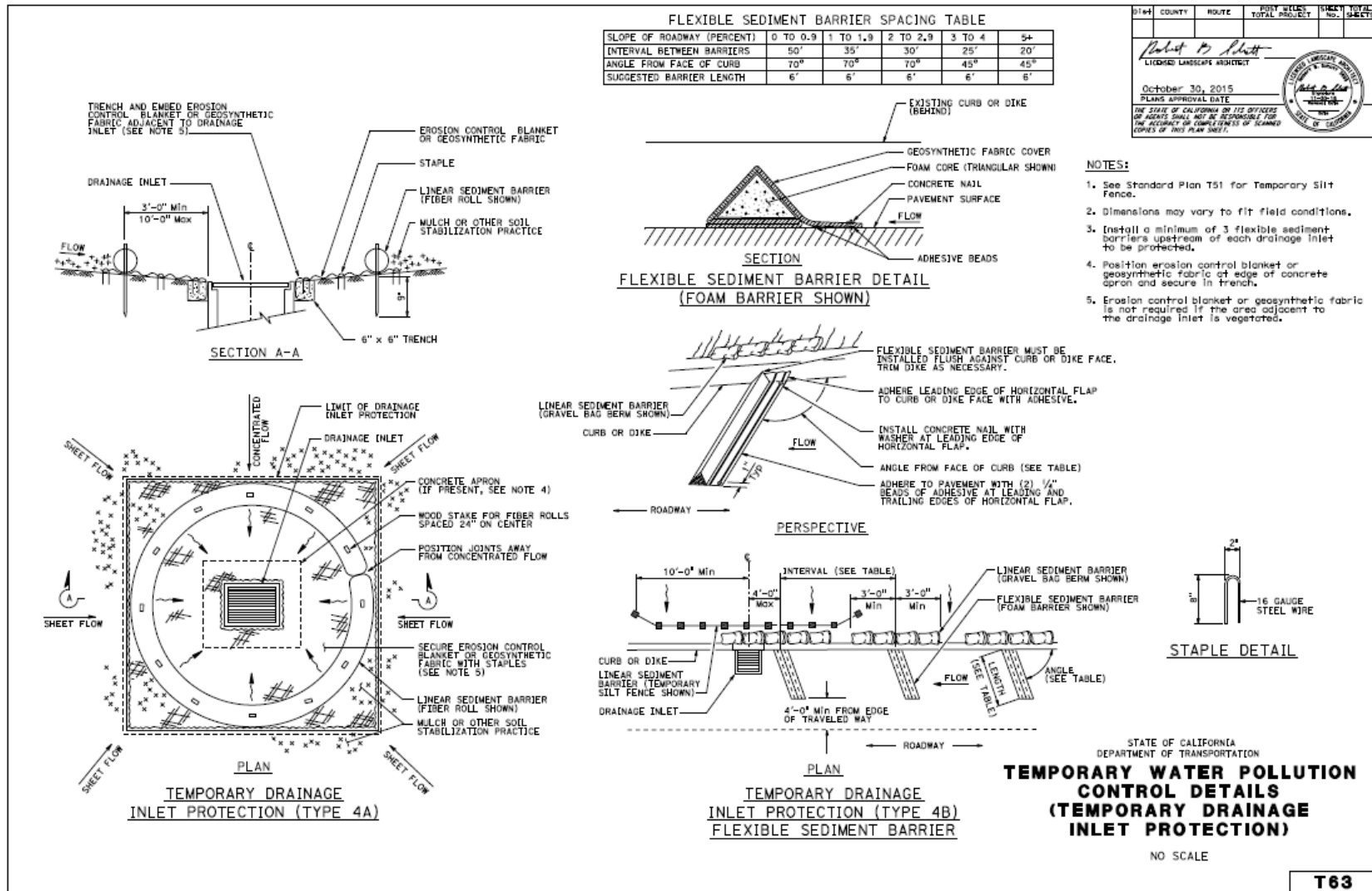

Figure C.5-3 Storm Drain Inlet Protection

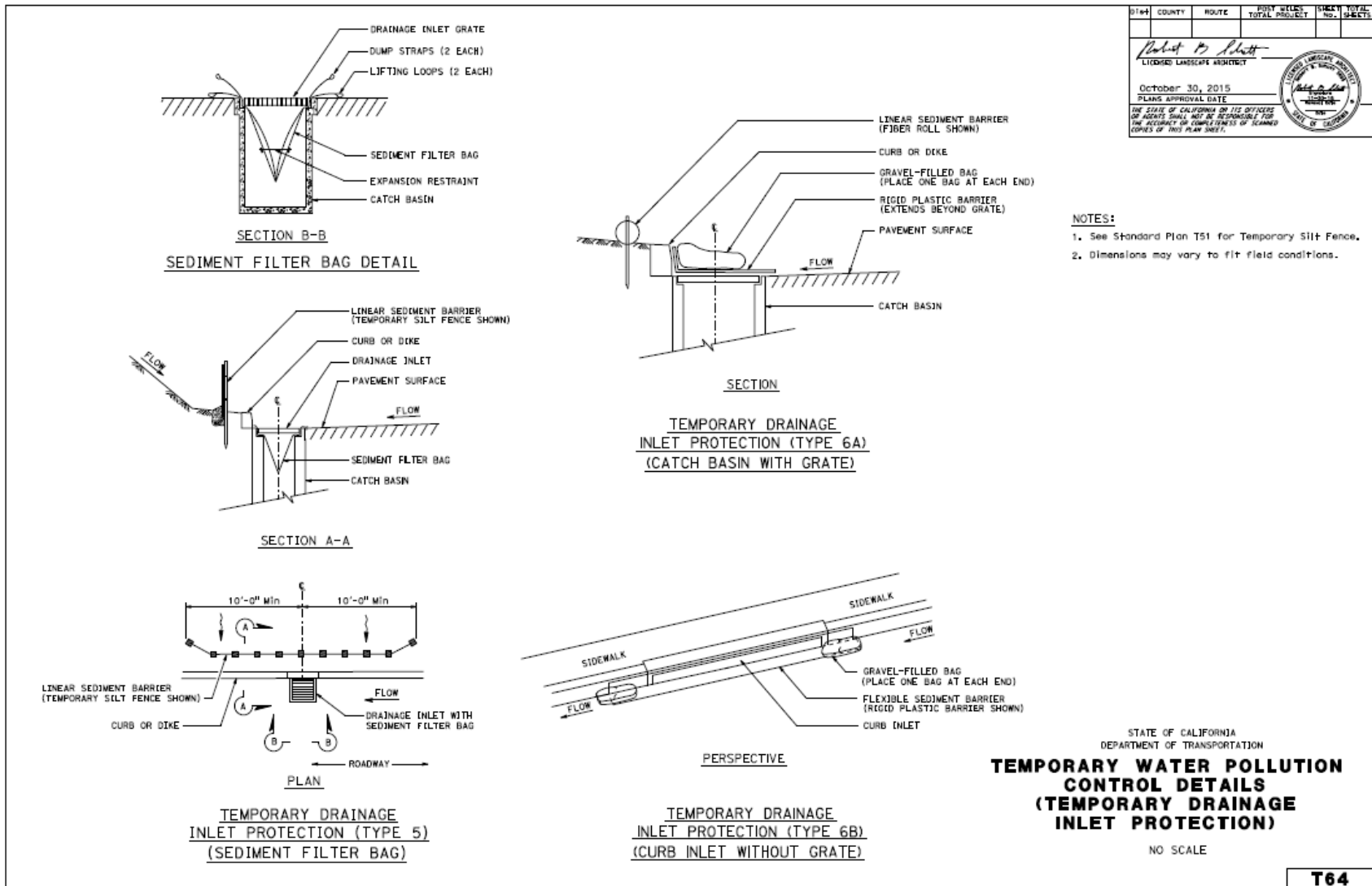

Figure C.5-4 Storm Drain Inlet Protection



## C.6 Concentrated Flow Conveyance Controls

Concentrated Flow Conveyance controls includes those practices that carry stormwater flow and diminish the potential for sediment transport or erosion to occur. These practices include:

C.6.1 Overside/Slope Drain

C.6.2 Ditches, Berms, Dikes and Swales

C.6.3 Temporary Diversion Ditches

Concentrated Flow Conveyance Controls are typically placed to divert temporary flows and prevent erosion, some applications can be permanent and might require consultation with hydraulics and other engineering units. Concentrated Flow Conveyance Controls require periodic inspection and maintenance.

### C.6.1 Overside/Slope Drains



Figure 6.1-1 Overside/Slope Drain

#### Description:

An oversee/slope drain is a pipe used to intercept and direct surface runoff into a stabilized watercourse, a trapping device or a stabilized area. Overside/slope drains are typically used to intercept and direct surface flow away from slope areas to protect slopes. Overside/slope drains installed during maintenance efforts may be temporary. Maintenance staff may receive assistance from design and or hydraulics for long-term installations or where installation is difficult.

#### Appropriate Applications:

- Slope drains may be used at sites where slopes have been eroded by surface runoff (Minor Slides and Slipouts Cleanup/Repair).
- Severe erosion may result if oversee/slope drains fail by overtopping, piping or pipe separation (overside/slope drains shall be inspected and maintained).

#### Implementation:

- When installing oversee/slope drains:
  - Limit drainage area per pipe. For areas larger than 10 acres, use a lined channel or a series of pipes.
  - Use ditches, berms, dikes and swales to direct surface runoff into the oversee/slope drain.
  - Secure the drain to the slope surface.
- Consider the following for installing oversee/slope drains:
  - Install perpendicular to slope contours.
  - Protect area around inlet. Protect outlet with riprap or other energy dissipation device. For high-energy discharges, reinforce riprap with concrete or use reinforced concrete device.
  - Compact soil around and under entrance, outlet and along length of pipe.
  - Securely anchor and stabilize pipe and appurtenances into soil.

**Maintenance:**

- Regularly inspect overside/slope drains and maintain drains to ensure they are secured to the slope.
- Check outlet for erosion and downstream scour. If eroded, repair damage and install additional energy dissipation measures. If downstream scour is occurring, it may be necessary to reduce flows being discharged into the channel unless other preventive measures are implemented.
- Check slope drain for accumulation of debris and sediment. Clean drains to maintain their capacity.

## C.6.2 Ditches, Berms, Dikes and Swales



Figure C.6.2-1 Rock-lined Swale

### Description:

Ditches, berms, dikes and swales are temporary or permanent measures used to intercept and direct surface runoff to an overside/slope drain or stabilized watercourse.

### Appropriate Applications:

- Ditches, berms, dikes and swales may be implemented for the following purposes:
  - To convey flow around maintenance activities;
  - To divert flow away from maintenance stockpiles;
  - At the top of slopes to divert run-on from adjacent slopes and areas;
  - At bottom and mid-slope locations to intercept sheet flow and convey concentrated flows;
  - At other locations to convey runoff to overside/drains, stabilized watercourses, stormwater drainage system inlets (catch basins), pipes and channels;
  - To intercept runoff from paved surfaces; and
  - Along roadways and facilities subject to flood drainage.

### Implementation:

- Evaluate risks due to erosion, overtopping, flow backups or washout.
- Consider outlet protection where localized scour is anticipated.
- Examine the site for run-on from off-site sources.
- Conveyances should be lined if high flow velocity is anticipated. Consider use of riprap, engineering fabric, asphalt concrete, or concrete.

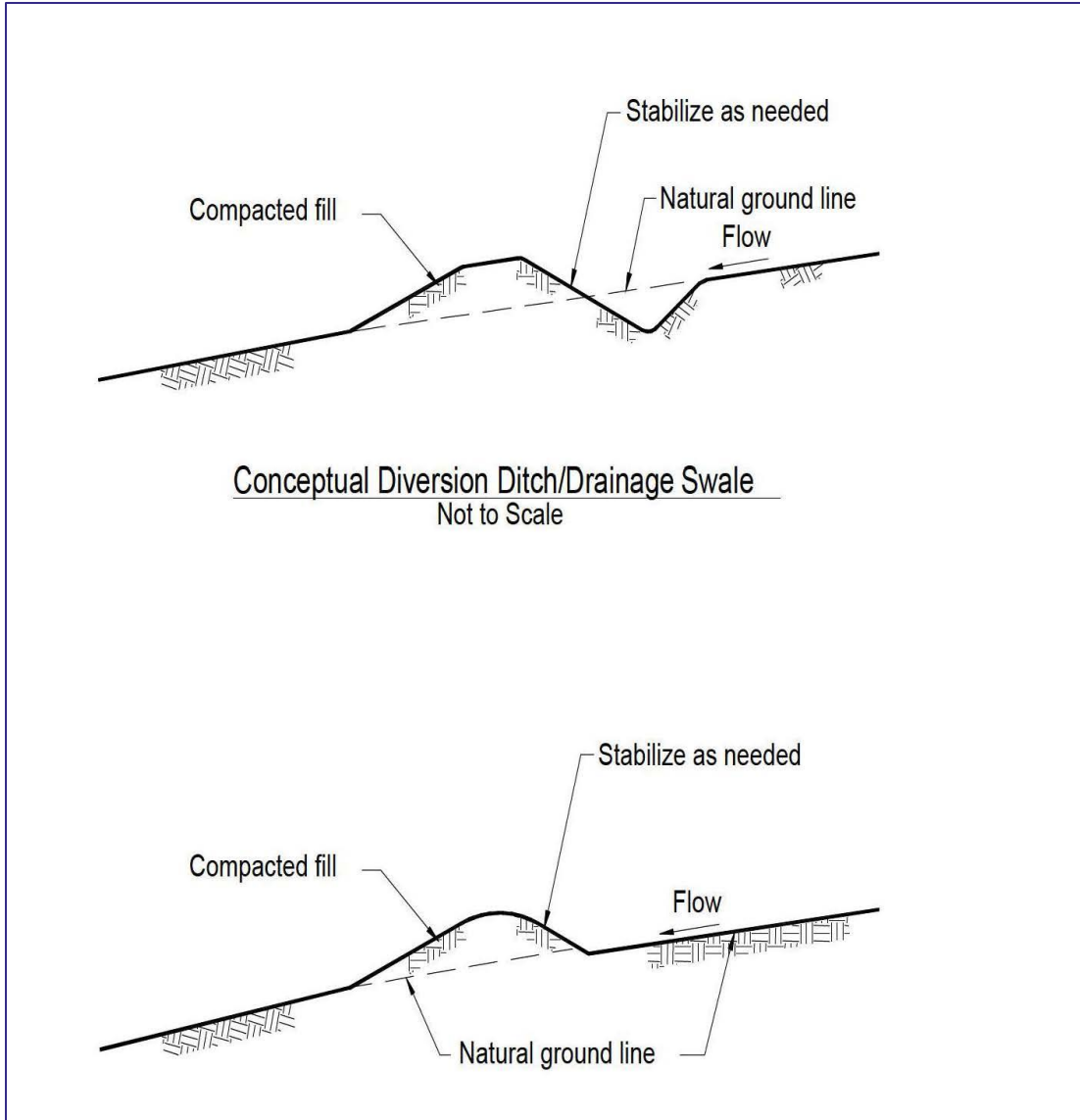

Figure C-6.2-2. Ditches, Berms, Dikes and Swales

### C.6.3 Temporary Diversion Ditches



Figure C.6.3.-1 Temporary Diversion Ditches

#### Description:

These are temporary measures used to intercept and direct surface runoff to an overside (or slope) drain or stabilized watercourse.

#### Appropriate Applications:

- Temporary diversion ditches may be implemented for one or more of the following purposes:
  - To convey flow around maintenance activities (most commonly during Minor slides and slipouts cleanup repair);
  - To divert flow away from maintenance stockpiles;
  - At the top of slopes to divert run-on from adjacent slopes and areas;
  - At bottom and mid-slope locations to intercept sheet flow and convey concentrated flows;
  - At other locations to convey runoff to overside drains, stabilized watercourses, stormwater drainage system inlets (catch basins), pipes and channels; and
  - To intercept runoff from paved surfaces.

#### Implementation:

- Evaluate risks due to erosion, overtopping, flow backups or washout.
- Consider protection where localized scour is anticipated.
- Examine the site for run-on from off-site sources.
- Conveyances should be lined if high velocities are anticipated. Consider use of riprap, engineering fabric, asphalt concrete or concrete.

## C.7 Soil Stabilization

Soil stabilization BMP's shall be implemented in accordance with each District's environmental requirements. Disturbed soil areas should be inspected and evaluated for soil stabilization/revegetation to reduce erosion. At the completion of maintenance activities, disturbed soil areas should be stabilized. Stabilization is also required for Minor slides and slipouts cleanup repair. Follow-up inspections should be performed to ensure that soil stabilization was successfully implemented.

Soil stabilization consists of preparing the soil surface and applying one of the following BMPs, or a combination thereof, to disturbed soil areas or erodible slopes:

- C.7.1 Compaction;
- C.7.2 Wood Mulch;
- C.7.3 Hydraulic Mulch;
- C.7.4 Hydroseeding/Handseeding;
- C.7.5 Soil Binders;
- C.7.6 Straw Mulch;
- C.7.7 Geotextiles, Mats/Plastic Covers and Erosion Control Blankets; and
- C.7.8 Riprap (Rock Slope Protection);

In some instances, disturbed soil areas may contain seed that will naturally germinate under the right conditions. Maintenance staff may elect to allow natural germination to occur, but these areas must be inspected and maintained if vegetation does not sprout and erosion is occurring. Temporary sediment control BMPs will need to be implemented to avoid erosion from these areas while the vegetation is being established.



### C.7.1 Compaction



Figure C.7.1. Compaction

#### Description:

Soil may be compacted to reduce the potential for erosion and transport of sediment to drainage systems or watercourse.

#### Appropriate Applications:

- Compaction is not an alternative to restoring vegetation. Compaction is restricted to areas where vegetation is undesirable or is not sustainable.
- Compaction is appropriate for unpaved shoulder areas following shoulder grading activities, guard rail post installation and sign post installation.

#### Implementation:

- The effect of runoff from the compacted soil on nearby surface water should be considered.
- The area should be evenly graded or leveled prior to compaction.
- Compaction should not be performed while stormwater runoff is observed.
- Compaction should be performed as soon as possible after grading or soil disturbance.
- Compaction may be combined with other BMPs (see Section C.7.2 Wood Mulch BMP and Section C.7.6 Straw Mulch BMP).
- Use recycled water only when pre-wetting soil for compaction.

#### Maintenance:

- Compacted areas shall be inspected to identify any evidence of erosion upon the completion of maintenance activities.

## C.7.2 Wood Mulch

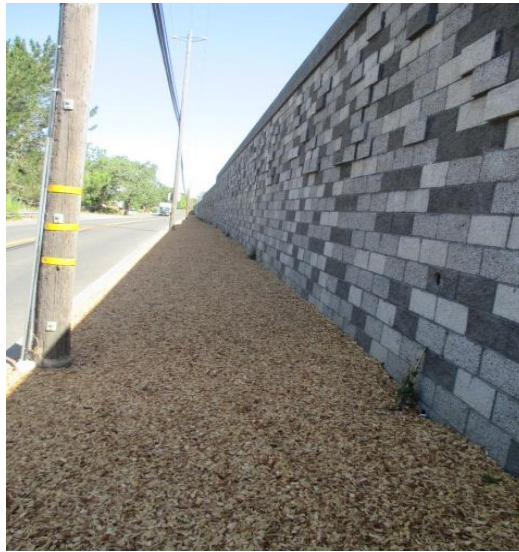

Figure C.7.2-1 Wood Mulch Application

### Description:

Wood mulch consists of applying chipped material or commercially available wood mulch products to reduce the potential for eroding the underlying soil. Wood mulch is readily available and has an attractive appearance. Wood mulch may be chosen over other stabilization measures to reduce germination of noxious weeds and the need for vegetation control measures. Wood mulch meeting Caltrans specifications is recommended for best performance.

### Appropriate Applications:

- Wood mulch is appropriate for landscaping applications (Building and Grounds Maintenance).
- Wood mulch may be considered as an option for the Roadside Stabilization activity (see C.26 Slopes Prone to Erosion and Sediment Discharge BMP).
- Wood mulch may also be considered as an option during Irrigation Line Repairs.
- Wood mulch should not be applied to steep slopes or placed into drainage paths that could receive concentrated flow. Wood mulch is prone to displacement under these conditions.

### Implementation:

- Contact the District Landscape Specialist, District Erosion Control Specialist or Landscape Architect for the appropriate application rates. Use the recommended application rate.
- Wood mulch may be applied by hand, with blowers or with chippers.
- Avoid application onto hardscaped areas.

### Maintenance

- Periodically inspect areas where mulch has been applied.
- Inspect areas for mulch displacement, erosion or accumulation near or in drainages inlets.

### C.7.3 Hydraulic Mulch

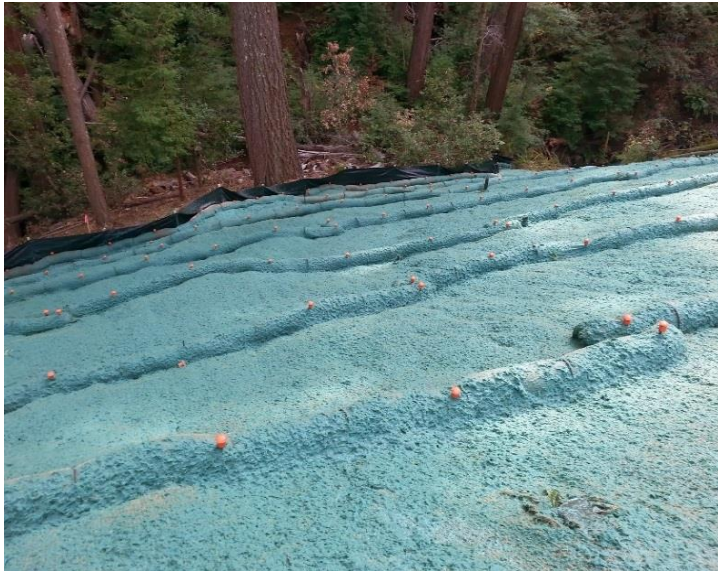

Figure C.7.3-1 Hydraulic Mulch Application

#### Description:

Hydraulic mulch is applied to disturbed soil areas that require protection. Hydraulic mulch consists of applying a mixture of natural or recycled fiber and a tackifier with hydro-mulching equipment. The mulch stabilizes the soil, reduces wind and water erosion and provides protection to seeds increasing survivability (see C.4.4 Hydroseeding/Handseeding BMP). It may be used as a temporary repair measure following maintenance activities (to be followed by other soil stabilization BMPs).

#### Appropriate Applications:

- Hydraulic mulch may be applied to steeper slopes than wood mulch.
- Hydraulic mulch can be applied to areas that receive more concentrated flow where wood mulch would be washed away.
- Hydraulic mulch may be an appropriate measure for Minor slides and slipouts cleanup repair.
- Hydraulic mulch may be used for stockpiled soil (see C.17 Stockpile Management BMP).
- Hydraulic mulch must be applied from different angles to provide adequate coverage.

#### Implementation:

- Contact the District Landscape Specialist, District Erosion Control Specialist or Landscape Architect for the appropriate application rates. Use the recommended application rate.
- Hydro-mulching equipment is used to apply hydraulic mulch.
- Avoid mulch over-spray onto hardscaped areas.

### C.7.4 Hydroseeding/Handseeding



Figure C.7.4.-1 Hydroseeding Application

#### Description:

Hydroseeding/Handseeding is a permanent soil stabilization method. Hydroseeding consists of applying a mixture of fiber, seed, fertilizer and stabilizing emulsion with hydro-mulching equipment. Other methods of seeding may also be used, including spreading by hand broadcasting or with a mechanical handsprayer. Replacement planting is also covered under this BMP.

#### Appropriate Applications:

- Hydroseeding/handseeding may be used on erodible surfaces which require protection (e.g., Minor slides and slipouts cleanup repair).

#### Implementation:

- Hydroseeding can be accomplished using a multiple-step or one-step process.
- Avoid over-spray onto hardscaped areas.
- Seed should be uniformly applied.
- Seed should be “scratched in” or covered with straw or soil (see C.4.6 Straw Mulch BMP).
- Contact the District Landscape Specialist or Landscape Architect for the appropriate seed type and application rate. The recommended seed type and application rate for the site conditions should be used.
- Temporary watering systems should be considered in critical areas. Consult the MSWC or Landscape Specialist for installation guidance.

#### Maintenance:

- Seeded or planted areas should be inspected for failures and revegetated, fertilized or mulched.



### C.7.5 Soil Binders



Figure C.7.5-1 Soil Binder Application

#### Description:

Soil binders consist of applying and maintaining polymeric or lignin sulfonate soil stabilizers or emulsions.

#### Appropriate Applications:

Soil binders may be applied to disturbed soil areas or soil stockpiles requiring short-term protection.

A variety of soil binders are available for use. Prior to use, the manufacturers' specifications should be reviewed and compared to the site-specific conditions. In selecting a soil binder, the following criteria should be considered:

- Availability of product;
- Ease of cleanup;
- Degradability (how the product degrades and what its by-products are);
- Length of drying time;
- Erosion control effectiveness;
- Longevity;
- Mode of application and availability of application equipment; and
- Water quality impact.

#### Implementation:

- Apply soil binders per manufacturer's specifications.
- Soil binders shall be nontoxic to plant and animal life.
- Soil binders shall not be applied to frozen soil or areas with standing water.
- Soil binders should not be applied during or immediately before rainfall.
- Avoid over-spray onto hardscaped areas.

- Storm water quality runoff sampling is required for many soil binders. The following copolymers/polymers have been sampled and are not known not to discharge pollutants and water quality sampling and analysis is not required Super Tak, M-binder, Fish Stik, Pro40dc, Fisch-Bond, Soil Master WR and EarthGuard.

**Maintenance:**

- Check protected areas to ensure proper coverage and re-apply soil binder as needed, or implement additional BMPs.

### C.7.6 Straw Mulch



Figure C.7.6-1 Straw Mulch Application

#### Description:

The application of straw mulch consists of placing of a uniform layer of straw. It may be attached by wetting, with an organic tackifier or by mechanical means. It is effective for short-term applications and may be combined with other BMPs (e.g., C.4.4 Hydroseeding/Handseeding BMP).

#### Appropriate Applications:

- Straw mulch may be an appropriate temporary measure for responding to Minor slides and slipouts cleanup repair.
- Straw mulch may be applied as a short-term measure to disturbed soil areas. It can be used in this manner for Building and Grounds Maintenance.
- Straw mulch may be used for Roadside Stabilization (see C.26 Slopes Prone to Erosion and Sediment Discharge BMP).
- Straw mulch may also be used in combination with permanent seeding strategies ( C.7.4 Hydroseeding/Handseeding BMP) to enhance plant establishment.
- Straw mulch can be applied to steeper slopes than wood mulch.

#### Implementation:

- Straw mulch should be derived from native grass, oat, wheat, rice or barley.
- Straw mulch with organic tackifier should not be applied during or immediately before rainfall.
- Avoid placing straw mulch onto hardscaped areas.
- The straw mulch must be evenly distributed on the soil surface.

#### Maintenance:

- Straw mulch should be periodically inspected and maintained until permanent stabilization measures or repairs are successful.
- Punching of straw does not work in sandy soils, requires the use of a tackifier.



### C.7.7 Geotextiles, Mats/Plastic Covers and Erosion Control Blankets



Figure C.7.7-1 Erosion Control Blanket Application

#### Description:

This BMP involves the placement of geotextiles, mats, plastic covers or alternative erosion control products to stabilize disturbed soil areas. These measures may be temporary or permanent.

#### Appropriate Applications:

- These measures are used where disturbed soils may be particularly difficult to stabilize, including steep slopes, slopes where erosion hazard is high and slopes where mulch must be anchored. They may be used for Slides and Slipouts Cleanup/Repair or Roadside Stabilization (see C.26 Slopes Prone to Erosion and Sediment Discharge BMP). Geotextiles, mats/plastic covers and erosion control blankets may also be used for disturbed soil areas where plants are slow to develop or where it is not the appropriate planting season. Geotextiles and mats/plastic covers may also be used in areas receiving concentrated flow. The use of plastic should be limited to short timeframes and cannot be used in areas near ESAs where wind can move the plastic and cause a problem for wildlife or habitat.

#### Implementation:

- These measures may be designed with input from geotechnical engineering or hydrology (especially if they are intended as permanent measures).
- Geotextiles, mats/plastic covers and erosion control blankets must be secured to the slope and installed in accordance with manufacturer's specifications.
- Proper site preparation ensures that the covers and products will have complete, direct contact with the soil.
- Illustrations of conceptual geotextiles, mats/plastic covers and erosion control blankets are shown in Figures C.7.7-2 through C.7.7-5.
- Open edge sides should be keyed to prevent underflow.

#### Maintenance:

- Inspect for erosion and undermining. Ensure the controls are secured to the slope until permanent soil stabilization has been successfully attained.

- If washout or breaks occur, repair the damage to the slope or channel whenever possible and re-install the material.
- Installation should be inspected after rain events to check for erosion and undermining. Any failures must be repaired immediately.

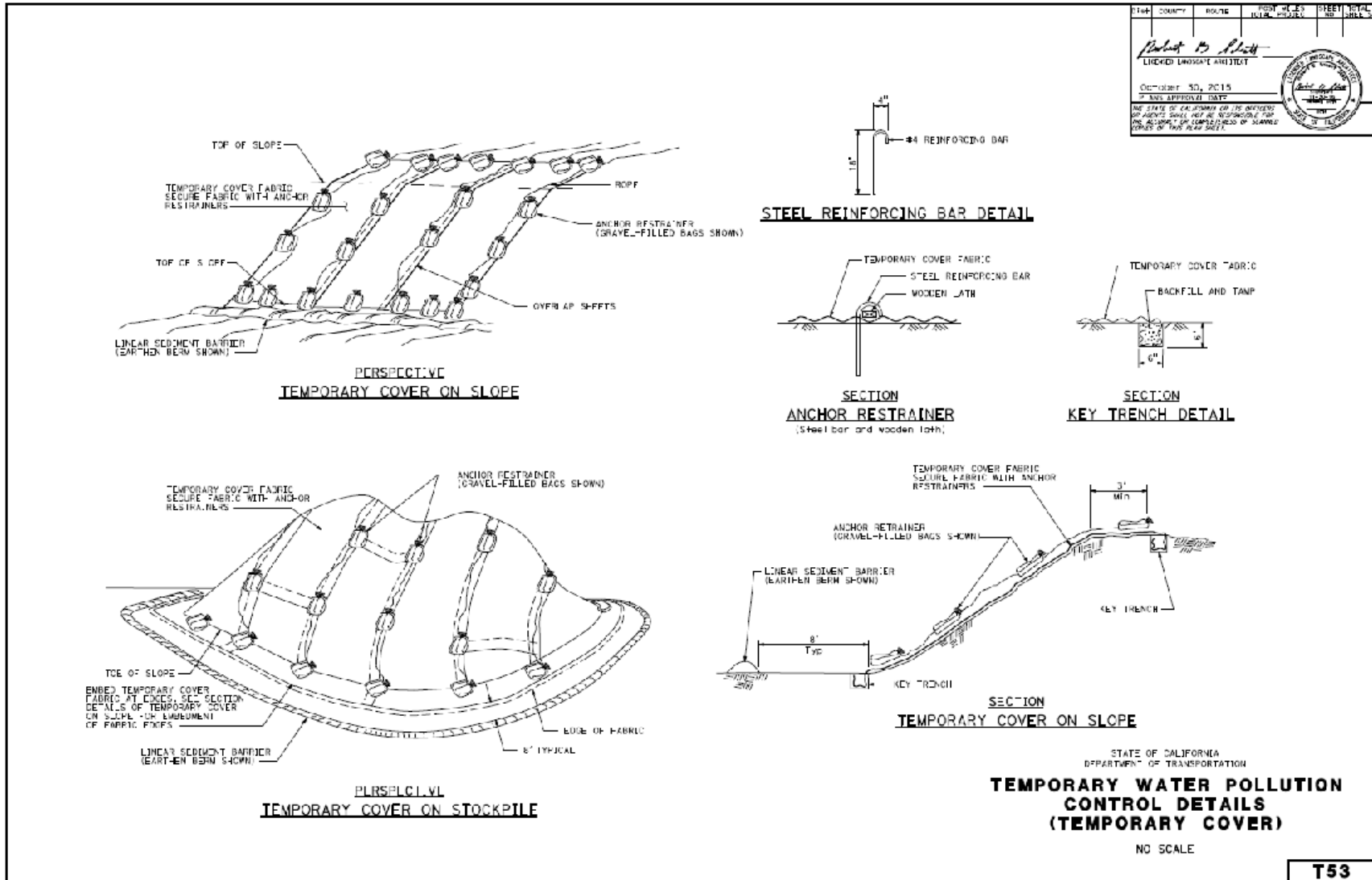

Figure C.7.7-2. Geotextiles, Mats/Plastic Covers and Erosion Control Blankets

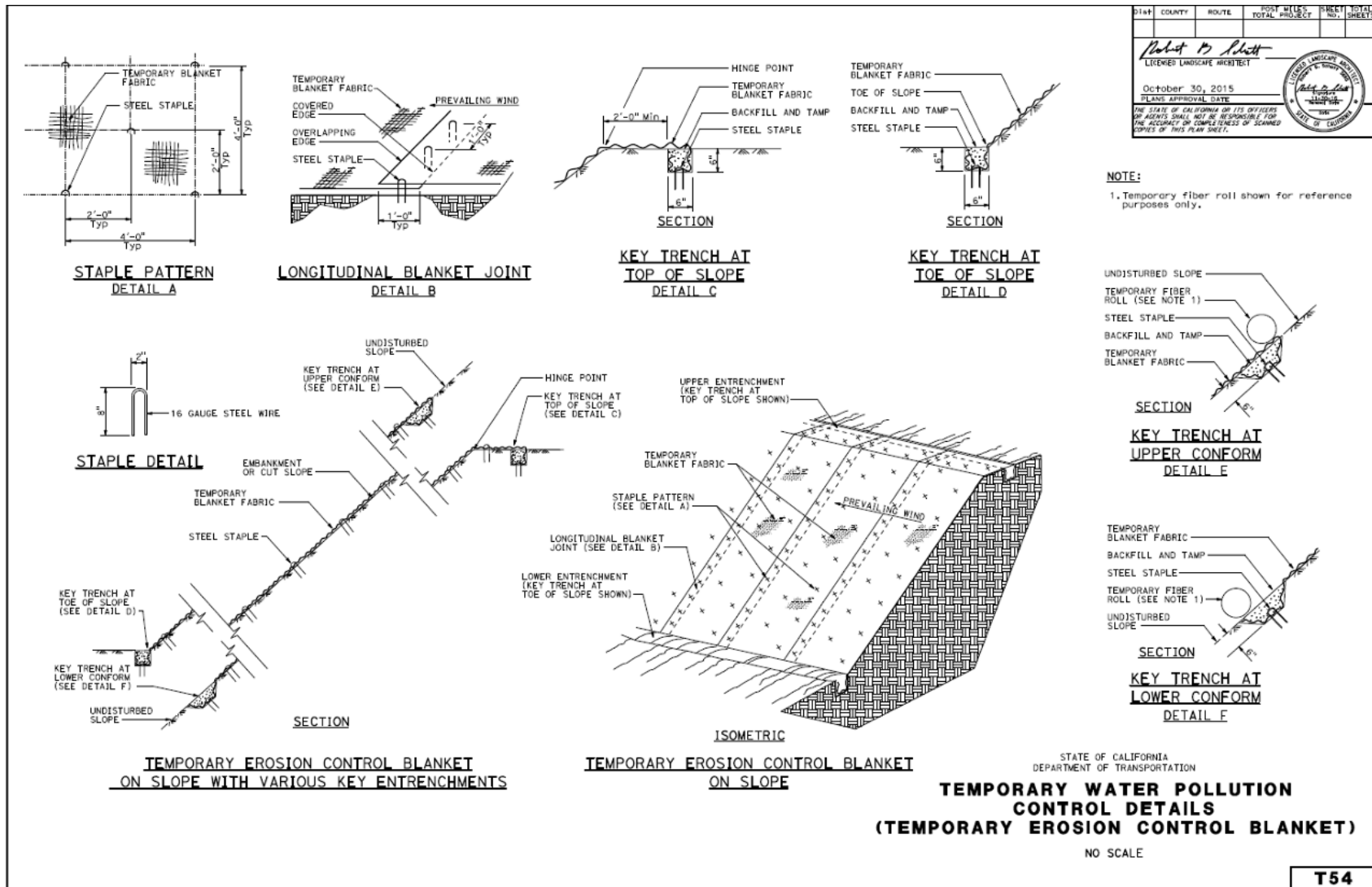

Figure C.7.7-3. Geotextiles, Mats/Plastic Covers and Erosion Control Blankets

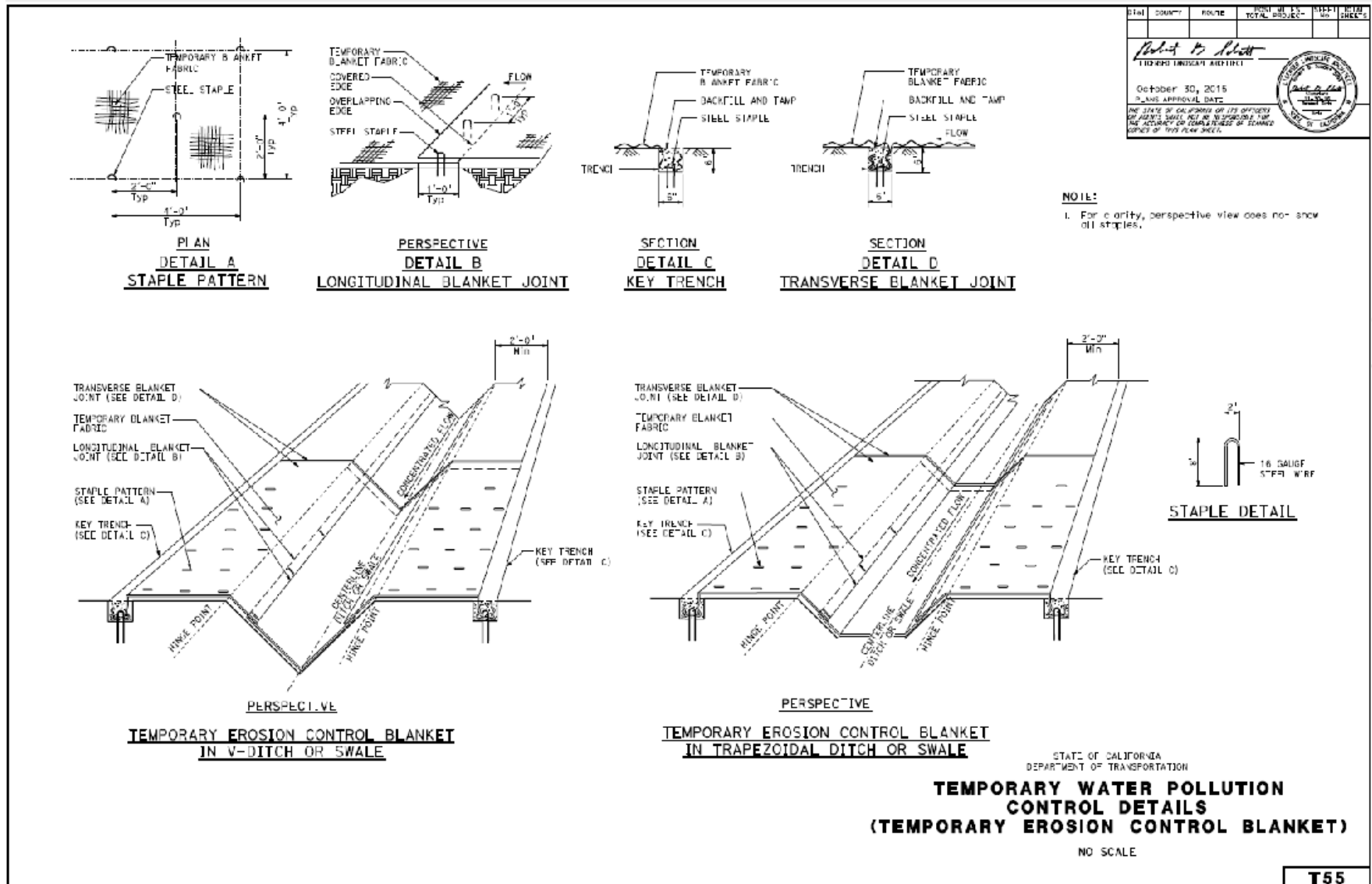

Figure C.7.7-4. Geotextiles, Mats/Plastic Covers and Erosion Control Blankets

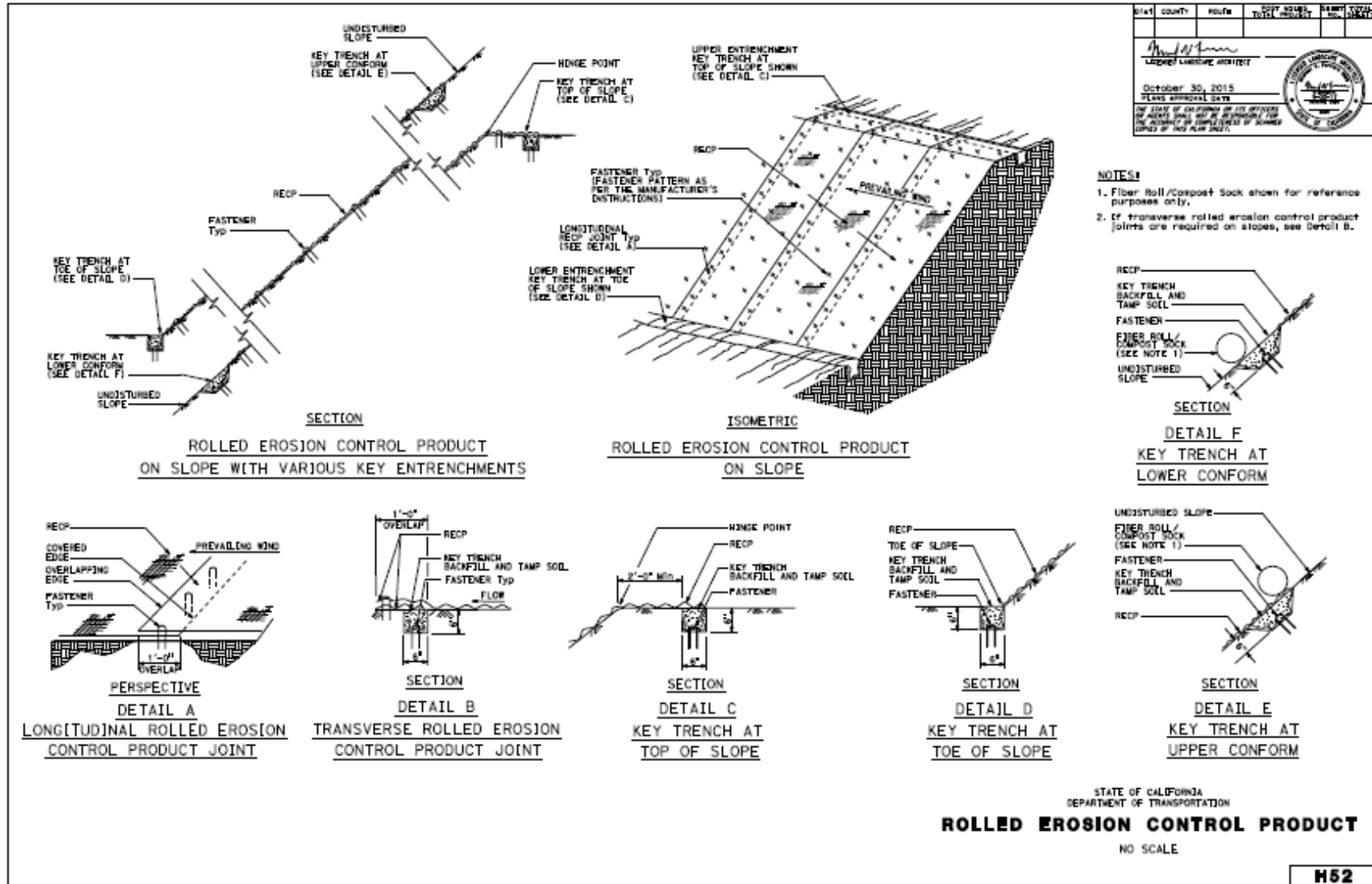

Figure C.7.7-5. Geotextiles, Mats/Plastic Covers and Erosion Control Blankets



### C.7.8 Riprap (Rock Slope Protection)



Figure C.7.8-1 Riprap Application

#### Description:

Riprap is placed in locations that receive concentrated flows including ditches, channels, slides and slipouts to prevent scour or reduce the energy of stormwater flows. Rock slope protection can also be used to stabilize slopes particularly when stabilization is needed immediately such as erodible slopes in sensitive areas with impending precipitation events.

#### Appropriate Applications:

- Riprap may be used as a temporary measure when working in channels (Drainage Ditch and Channel Maintenance).
- Riprap can be used as a temporary or permanent measure for Slides and Slipouts Cleanup/Repair.
- Riprap may be used as a velocity dissipation measure on slopes and near pipe outlets or on the banks of channels to reduce erosion.

#### Implementation:

- Install riprap or grouted riprap.
- Riprap may be used as a permanent measure to stabilize erodible slopes.
- When considering slope stabilization with riprap esthetics should be considered.

#### Maintenance:

- Inspect riprap periodically and restore as necessary.
- Check for scour beneath riprap and repair damage as needed.
- Inspect for standing water.
- When installing riprap as a channel lining, the channel needs to be excavated adequately to maintain flow line with the thickness of riprap.



- Consult the MSWC and/or the Maintenance Engineering for installation of geotextile fabric beneath riprap and appropriate rock size.

## C.8 Preservation of Existing Vegetation



Figure C.8-1 Preservation of Vegetation

### Description:

Preservation of existing vegetation is the identification and protection of desirable vegetation that provides erosion and sediment control benefits. For activities involving the removal of vegetation, the limits of disturbance should be defined to minimize adverse effects on vegetation outside the working area. When removed vegetation shall be used as duff, the duff shall consist of a mixture of existing decomposed, chopped, broken or chipped plant material, leaves, grasses, weeds, and other plant material excavated from areas within the work area limits. Existing shrubs and other small plants shall be incorporated into the duff by dicing, or by other methods which will break or chop the material into particles not greater than 0.5 foot in greatest dimension.

### Appropriate Applications:

- Vegetation should be preserved during the following activities:
  - Shoulder Grading;
  - Drain and Culvert Maintenance;
  - Drainage Ditch and Channel Maintenance;
  - Chemical Vegetation Control;
  - Manual Vegetation Control;
  - Mechanical Vegetation Control/Mowing;
  - Tree and Shrub Pruning, Brush Chipping, Tree and Shrub Removal;
  - Public Facilities;
  - Minor Slides and Slipouts Cleanup/Repair; and
  - Buildings and Grounds Maintenance.
- Preserve existing vegetation where no maintenance activity is planned or where activities will occur at a later date. Preserve existing vegetation to the maximum extent practicable.

## Implementation:

The following general steps should be taken to preserve existing vegetation:

- Ensure that the limits of disturbance are identified. Vegetation disturbed outside these limits should be replaced if damaged (see C.4.4 Hydroseeding/Handseeding BMP)
- Minimize disturbed areas by locating temporary roadways to avoid stands of trees and shrubs. Follow existing contours to reduce cutting and filling.
- Minimize the number of access and egress points and locate them to reduce damage to existing vegetation.
- Maintenance materials and equipment storage and parking areas should be located where they will not cause root compaction.
- Keep equipment away from trees to prevent trunk damage and root damage.
- Consider the impact of grade changes to existing vegetation and the root zone.
- Avoid placing soil around trunks of trees.

Duff stockpiles should be protected from run-on and run-off by the use of linear sediment controls.

## C.9 Clear-Water Diversion



Figure C.9-1 Clear Water Diversion

### Description:

Clear-water diversion consists of a system of structures and measures that intercept surface water, transport it around a maintenance activity site and discharge it downstream with minimal water quality degradation. Structures commonly used as part of this system include diversion ditches, berms, dikes, slope drains and drainage and interceptor swales. Clear water diversions might require regulatory permits such as water quality certification (CWA 401) issued by the RWQCBs.

### Appropriate Applications:

- Clear-water diversions would most likely be implemented during minor slides and slipouts cleanup repair.
- It is possible that a clear-water diversion may be implemented when working on a ditch line or channel.
- Channel diversions are appropriate for small stream where there is adequate right of way to create a temporary channel around the work area, and geosynthetics or rock can be used to handle the expected flows.
- Berms are appropriate for small perennial, intermittent, or ephemeral streams with temporary culverts or pipe diversions. Berms may also be used to shift flows to one side or the other within a channel.
- Gravel bag berms are appropriate for smaller streams.
- Cofferdams are appropriate for small streams and lakes to confine flows to one side, create a dry work area, or to berm the entire small streams.
- Pumped diversions are suitable for short-term projects in intermittent and low flow streams. Excavation of a temporary bypass channel or passing the flow through a pipe is appropriate for the diversion of streams less than 20 ft wide, with flow rates less than 100 cfs.
- Depending on the complexity and flows of the stream, Maintenance engineering should be consulted.

### Implementation:

- Clear-water diversions shall not be performed without prior approval and required regulatory permits.

- Stationary equipment (such as motors and pumps) located within or adjacent to a water body should be positioned over drip pans.
- When any artificial obstruction is being constructed, maintained or placed in operation, sufficient water shall at all times be allowed to pass downstream to maintain aquatic life downstream.
- Where possible, avoid or minimize diversion impacts by scheduling work during periods of low flow or when the stream is dry.
- Disturbance or removal of vegetation should not exceed the minimum necessary to complete operations. Precautions shall be taken to avoid damage to vegetation by people or equipment.
- Provide for velocity dissipation at transitions in the diversion, such as the point where the stream is diverted to the channel and the point where the diverted stream is returned to its natural channel.
- If the presence of polluted water or sediment is identified, dewatering controls may be required.
- Remove diversions when the maintenance activity is completed and restore the area to the condition it was before any maintenance activity took place.

## C.10 Work in a Waterbody



Figure C.10-1 Work in a Waterbody

### Description:

Maintenance activities occasionally require equipment or personnel to enter a stream, river, channel or other water body. This BMP describes measures that are required for maintenance activities in water bodies.

### Appropriate Applications:

- Although working in a water body is not routine, Minor Slides and Slipouts Cleanup/Repair, Drainage Ditch and Channel Maintenance, Bridge Repairs and Draw Bridge Maintenance could require work in a water body.

### Implementation

- Maintenance equipment shall not enter a water body without the required regulatory permits (e.g., Army Corps of Engineers, Clean Water Act Section 404 permit, California Department of Fish and Wildlife Code Section 1602 Agreement, Clean Water Act Section 401 Water Quality Certification and ESA Section 7). The Maintenance Storm Water Coordinator should be contacted to identify the appropriate permits.
- Evaluate alternatives to performing work in the water body.
- Tires shall be cleaned before entering a water body.
- Place drip pans and absorbent materials under equipment and ensure that an adequate supply of spill cleanup materials is onsite.
- Heavy equipment driven into a water body to accomplish work should be clean of petroleum residue, suggest use of timber mats to minimize impacts to creek bed.
- Water levels should be below the gear boxes of the equipment in use, or equipment lubricants and fuels should be sealed such that inundation by water shall not result in leaks.
- Secure all materials to prevent discharges to receiving waters via wind.

- Inspect equipment routinely and repair equipment as needed (e.g. worn or damaged hoses, fittings, gaskets).



## C.11 Wind Erosion Control



Figure C.11-1 Wind Erosion Control

### Description:

Wind erosion control consists of applying water or other dust palliatives as necessary to prevent or alleviate dust nuisances. Covering of small stockpiles is an alternative to applying water or other dust palliatives. This BMP may be combined with C.4 Sediment Controls BMP.

### Appropriate Applications:

- Wind erosion controls should be implemented for stockpiles of loose materials.
- This practice is also implemented on disturbed soils subject to wind erosion (including Shoulder Grading, Roadside Stabilization and Minor Slides and Slipouts Cleanup/Repair).

### Implementation:

- Evaluate suspending work under windy conditions when loose materials are prone to erosion.
- All distribution equipment shall be equipped with a positive means of shutoff.
- At least one mobile unit should be available to apply water or dust palliative to the maintenance activity site.
- Only potable and non-potable (uncontaminated) water shall be used. Reclaimed wastewater or otherwise contaminated water shall not be used. Disinfected secondary-23 recycled water may be used for dust control and soil compaction.
- Materials applied as temporary soil stabilizers may also provide wind erosion control benefits (see C.7 Soil Stabilization BMPs).
- Do not apply excess water to avoid ponding or runoff onsite. Non-stormwater discharges are prohibited.
- Identify and stabilize key access points with the use of tracking controls BMPs.

### Maintenance:

- Inspect protected areas to ensure proper coverage.
- Most water-based dust control measures require frequent application.

## C.12 Tracking Control

Sediment tracking controls are implemented to avoid tracking sediment from maintenance activity sites or maintenance facilities onto public roads or the highway. These controls include:

- C.12.1 Stabilized Activity Entrance/Exit;
- C.12.2 Tire Inspection and Sediment Removal; and

At a minimum, one of these BMPs should be implemented when unpaved areas will be involved either as parking or access areas or other parts of the maintenance activities and are likely to introduce sediment onto the highway. For extended maintenance activities or site conditions where considerable material tracking will occur, a combination of these BMPs should be considered.

### C.12.1 Stabilized Activity Entrance/Exit



Figure C.12-1 Stabilized Activity Entrance/Exit

#### Description:

This temporary control practice is a defined point of entrance/exit to a maintenance site that is stabilized to reduce the tracking of mud and soil onto public roads by maintenance vehicles.

#### Appropriate Applications:

- Use at maintenance activity sites where sediment may be tracked onto public roads by maintenance vehicles.

#### Implementation:

- Limit the points of entrance/exit to the maintenance activity site.
- Stabilize entrance/exits with rock aggregate, commercially available manufactured steel-ribbed plate or other suitable material. Refer to Figures C.12.1-2.
- Class 8 RSP fabric shall be used to line the temporary activity entrance/exit.
- Keep a 6-inch layer of rock over the fabric to prevent damage from the spreading equipment.
- Route runoff from the stabilized activity entrance/exit through a sediment trapping device before discharge.

#### Maintenance:

- Inspect entrance/exit for functionality.
- Replace or supplement rock aggregate as needed.
- Periodically clean steel-ribbed plates.

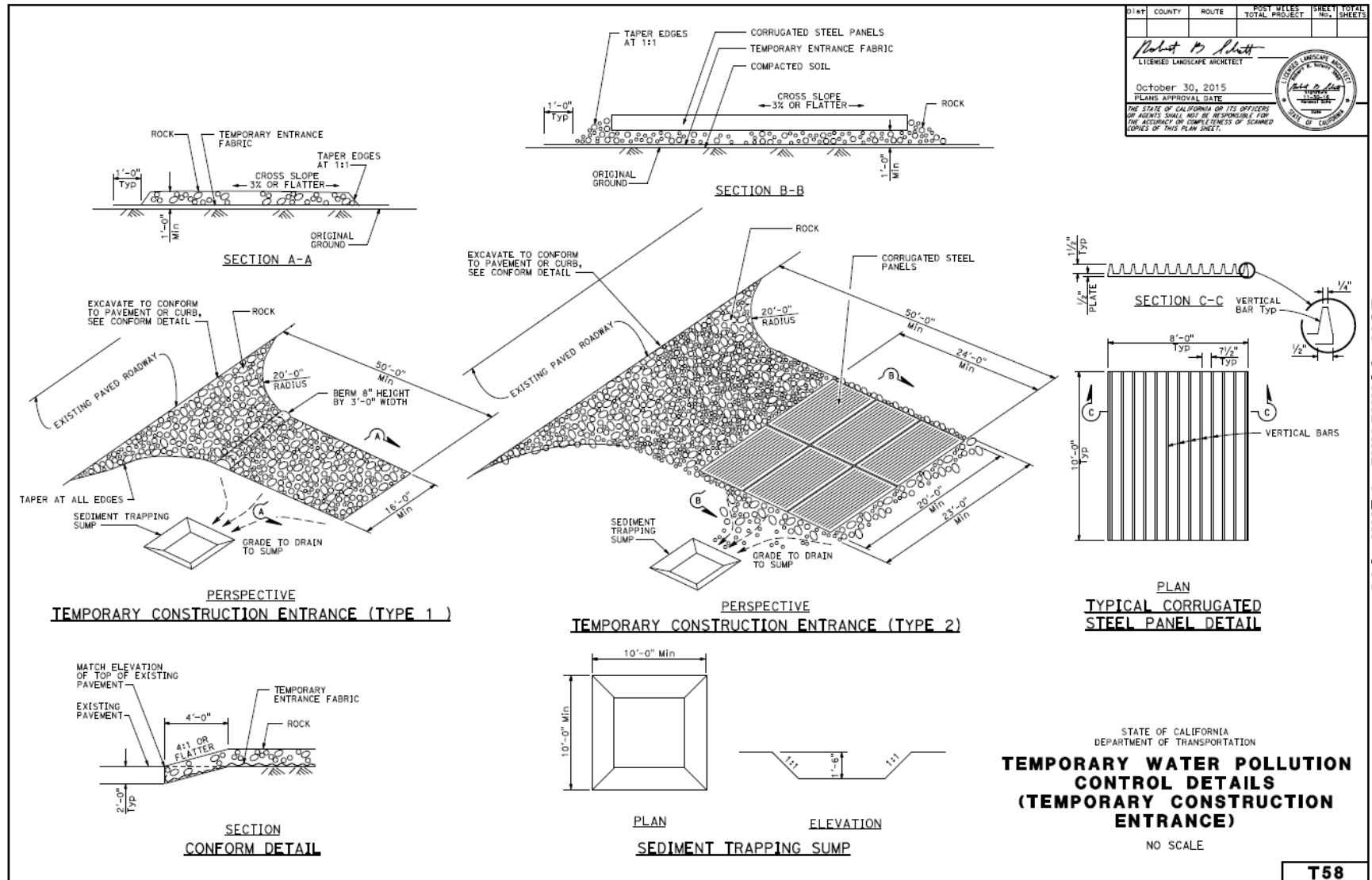

Figure C.12.1-2. Stabilized Construction Entrance/Exit

### C.12.2 Tire Inspection and Sediment Removal



Figure C.12.2-1 Tire Inspection and Sediment Removal

#### Description:

Tires are inspected and sediment is removed to reduce tracking of sediment onto public roads or the highway.

#### Appropriate Actions:

- Tires should be inspected after the completion of off-road activities. Sediment should be removed as needed.

#### Implementation:

- Inspect tires prior to entering the roadway after off-road work.
- Use dry cleanup techniques to remove rock and sediment from tires prior to leaving the worksite.
- Any water use should not be allowed to be discharged or enter a storm drain or other conveyance system.

## C.13 Waste Management

Waste management consists of implementing procedural and structural BMPs for handling, storing and disposing of wastes generated by a maintenance activity to prevent the release of waste materials into stormwater discharges. Injection wells used for disposal of stormwater, wash water, septic effluent if used by 20 or more users per day, and other wastewater shall be registered with the EPA.

Waste management includes the following BMPs:

- C.13.1 Spill Prevention and Control;
- C.13.2 Solid Waste Management;
- C.13.3 Hazardous Waste Management;
- C.13.4 Contaminated Soil Management;
- C.13.5 Sanitary/Septic Waste Management;
- C.13.6 Liquid Waste Management; and
- C.13.7 Concrete Waste Management.

These controls shall be implemented for all applicable activities, material usage and site conditions.



### C.13.1 Spill Prevention and Control



Figure C.13.1-1 Spill Prevention and Control

#### Description:

Spill prevention and control procedures and practices are implemented to prevent and control spills in a manner that minimizes or prevents discharge to stormwater drainage systems or watercourses at maintenance activity sites and maintenance facilities (see C.14.2 Material Use BMPs for additional materials handling procedures).

#### Appropriate Applications:

- These controls apply at maintenance activity sites and at maintenance facilities.
- Spill prevention and control procedures are implemented wherever non-hazardous chemicals and/or hazardous substances are stored or used. Substances may include, but are not limited to, soil stabilizers, dust palliatives, pesticides, growth inhibitors, fertilizers, paints, de-icing chemicals, fuels, lubricants and other petroleum distillates.
- To the extent that the cleanup work can be accomplished safely, spills shall be contained and cleaned up immediately.

#### Implementation:

- Contain spread of the spill. For spills that enter or have the potential to enter water conveyance systems, the supervisor shall notify the Maintenance Stormwater Coordinator and the HazMat Coordinator.
- To the extent that it does not compromise safety or cleanup activities, spills shall be covered and protected from stormwater run-on during rainfall. If the spill occurs during rain, cover spill with tarps or other material to prevent contaminating runoff and provide drainage protection.
- Spills shall not be buried. Used clean up materials, contaminated materials, and recovered spill material that is no longer suitable for the intended purpose shall be stored and disposed of in conformance with local agency regulations.
- If the spill occurs in dirt areas, immediately contain the spill by constructing an earthen dike. Excavate and properly dispose of contaminated soil.



- If the spill occurs on paved or impermeable surfaces, clean up using "dry" methods (absorbent materials, cat litter and/or rags). Contain the spill by encircling with absorbent materials and do not let the spill spread widely.
- Water used for cleaning and decontamination shall not be allowed to enter storm drains or watercourses and shall be collected and disposed of in accordance with C.13.6 Liquid Waste Management.
- Waste storage areas shall be kept clean, well-organized and equipped with ample clean-up supplies as appropriate for the materials being stored.
- Perimeter controls, containment structures, covers and liners shall be repaired or replaced as needed to maintain proper function.
- Refer to the District Hazardous Spill Contingency Plan for guidelines on spill requirements. The purpose of Spill Prevention and Control BMP is to prevent water contamination from spills and cleanup activities.
- To contain significant or hazardous spills of substances on highway rights of way Caltrans will take action to contain spilled material, to remove it or to have it removed by the spiller or by a qualified contractor, and to ensure it is disposed of properly after proper identification and hazard assessment. Guidelines are outlined in Maintenance Manual Vol. 1, Chapter D5 – Spills of Substances on Highway Rights of Way.

### Maintenance:

- Verify that spill control cleanup materials are located near material storage, unloading and use areas and fueling locations. Spill kits shall be clearly identified at facilities.
- Update spill prevention and control plans and stock appropriate cleanup materials whenever changes occur in the types of chemicals stored on site.

### C.13.2 Solid Waste Management



Figure 13.2-1 Solid Waste Management

#### Description:

Solid waste management procedures and practices are designed to minimize or eliminate the discharge of pollutants to drainage systems or watercourses associated with the stockpiling or removal of maintenance activity wastes. Certain solid wastes may be reused under specific conditions allowed the Department such as asphalt concrete grindings under the California Department of Fish and Wildlife MOU (see Appendix D).

#### Appropriate Applications:

Solid waste management practices are implemented during maintenance activities that generate solid wastes. These solid wastes include, but are not limited to:

- Maintenance wastes, including sweeper waste, drain cleaning waste, brick, mortar, asphalt concrete, Portland cement, concrete, timber, steel and metal scraps, pipe and electrical cuttings, nonhazardous equipment parts, styrofoam, grindings, sandblast grit and other materials used to transport and package maintenance materials;
- Highway planting wastes, including vegetative material, plant containers and packaging materials; and
- Litter and debris, including food containers, beverage cans, coffee cups, paper bags and plastic wrappers.

#### Implementation:

- Recycle, reuse or properly dispose of solid waste. Salvage or recycle useful vegetation debris, packaging and/or surplus building materials when practical. For example, trees and shrubs from land clearing can be converted into wood chips, and then used as mulch on graded areas. Wood pallets, cardboard boxes, and maintenance scraps can also be recycled.
- Use dry cleanup techniques (e.g., vacuuming, sweeping, dry rags) to remove solid waste from the maintenance activity site when practicable. Use another technique only when dry cleanup techniques are not practicable, such as having to wet for dust control for safety or air quality reasons.

- Stormwater run-on shall be prevented from contacting stored solid waste through the use of ditches, berms, dikes and swales (see C.6 Concentrated Flow Conveyance Controls BMP) or through the use of measures to keep waste off surface water.
- To prevent clogging of the storm drainage system litter and debris, removal from drainage grates, trash racks, and ditch lines shall be a priority under safe conditions.
- Littering on the facility site shall be prohibited. Keep the site clean of litter and debris. Covered trash receptacles shall be provided in the facility yard, and at locations where workers congregate for lunch and break periods.
- Dumpsters of sufficient size and number shall be provided to contain and properly service the solid waste generated by the activity or facility and serviced properly.
- Material waste shall be stored in a designated area approved by the supervisor. Waste material visible to the public shall be stored or stacked in an orderly manner.
- Solid waste storage areas at maintenance facilities and in field sites should be located at least 50 feet away from downstream drain inlets, stormwater drainage systems or watercourses and shall not be located in areas prone to flooding or ponding.
- Except during fair weather, maintenance and highway planting waste not stored in watertight waste storage containers shall be secured and covered from wind and rain by covering the waste.
- Litter stored in collection areas and containers shall be handled and disposed of by trash hauling contractors if not disposed of by maintenance staff.
- Decomposable waste shall not be allowed to remain on site for more than seven days.
- District Maintenance staff removal of illicit discharges consisting of illegal dumping including animal carcasses shall be in accordance with the Maintenance Manual Vol. 1, Chap. D1, Section D1.08. Animal carcasses shall not be relocated to or disposed of within 150 feet of waterways or drainage ways or buried within five feet of groundwater. Area superintendents shall provide disposal procedures subject to local rules and regulations.
- Construction, demolition, and other non-hazardous solid waste materials shall be removed from the work site and the contents shall be disposed of outside the highway right-of-way in conformance with the local agency regulations.
- For disposal of hazardous waste, see C.13.3, Hazardous Waste Management.
- Have hazardous waste hauled to an appropriate disposal and/or recycling facility.
- Make sure that toxic liquid wastes (e.g., used oils, solvents, and paints) and chemicals (e.g., acids, pesticides, additives, curing compounds) are not disposed of in storage designated for debris. Waste storage washout on the job site is not allowed.
- Removal and disposal of landslide debris containing no construction and demolition waste is excluded provided that the material removed from such sites is disposed in accordance with applicable law. No application or notification is required and state minimum standards do not apply, however, the LEAs have authority to inspect excluded sites to verify that they do not qualify for a higher tier and to take any appropriate enforcement action and local nuisance standards may still apply. Title 14, CCR, Division 7 Section 18102 and 17388.2.

### Maintenance:

- Periodically inspect the solid waste storage areas and review the disposal procedures.
- Repair or replace damaged or missing BMPs.
- Full dumpsters/containers shall be removed from the project site and the contents disposed of outside the highway right-of-way.

- Any containers or dumpsters shall have a cover and be water-tight unless under sheltered from rain and wind.

### C.13.3 Hazardous Waste Management



Figure C.13.3-1 Hazardous Waste Management

#### Description:

Hazardous waste management procedures and practices are designed to minimize or eliminate the discharge of pollutants at maintenance activity sites and maintenance facilities to stormwater drainage systems or watercourses.

#### Appropriate Applications:

Hazardous waste management practices are implemented during maintenance activities and at maintenance facilities that generate or store hazardous waste from the use of petroleum products, asphalt products, concrete curing compounds, pesticides, acids, paints, solvents, wood preservatives, stains, roofing tar and any other materials considered a hazardous waste.

#### Implementation:

- The District HazMat Manager is the Maintenance Division lead for Maintenance HazMat activities. Maintenance staff shall contact the HazMat Manager immediately if wastes are generated or encountered within the Department's Right of Way requiring special HazMat handling procedures.
- Wastes shall be stored in sealed containers constructed of a suitable material and shall be labeled as required by Title 22 CCR, Division 4.5 and 49 CFR Parts 172,173, 177, 178, and 179.
- All hazardous waste shall be stored, transported, and disposed as required in Title 22 CCR, Division 4.5 and 49 CFR 260-263.
- Waste containers shall be stored in temporary containment facilities that shall comply with the following requirements:
- Temporary containment facility shall provide for a spill containment volume of 10% of the total volume of all containers, or 100% of the capacity of the largest tank within the containment, whichever is greater. For outdoor containment without cover, consider added precipitation from a 24-hour 25-year storm event.

- Temporary containment facilities shall be impervious to the materials stored there for a minimum contact time of 72 hours.
- Incompatible materials, such as chlorine and ammonia, shall not be stored in the same temporary containment facility.
- All hazardous waste shall be stored, transported and disposed in accordance with federal, state and local regulations. Refer to the Department's [Maintenance Hazardous Waste Manual](#). For example, the Hazardous Waste Manual includes the following: Chapter 2 *Hazardous Waste Storage*; Chapter 3 *Disposal of Hazardous Waste*; and Appendix E Section D5.07 *Cleanup and Transport Requirements for Government Agencies*.
- Waste shall be disposed of outside the highway right-of-way within 90 days of being generated. In no case shall hazardous waste storage exceed requirements in Title 22 CCR, Section 66262.34.
- Waste shall be disposed of by a licensed hazardous waste transporter at an authorized and licensed disposal facility or recycling facility utilizing properly completed Uniform Hazardous Waste Manifest forms.
- Make sure that toxic liquid wastes (e.g., used oils, solvents, and paints) and chemicals (e.g., acids, pesticides, additives, curing compounds) are not disposed of in dumpsters designated for solid waste maintenance debris.
- Properly dispose of rainwater in secondary containment that may have mixed with hazardous waste.
- Recycle any useful material such as used oil or water-based paint when practical.
- Maintenance staff are to follow label instructions regarding the proper handling, mixing and application of materials which could generate hazardous waste and a discharge to waterways.
- Maintenance staff shall implement good housekeeping procedures and exercise care and caution when handling hazardous materials capable of generating wastes that could create a contaminated water discharge. (e.g., Paint brushes and equipment for water- and oil-based paints shall be cleaned within a contained area and associated waste shall not be allowed to contaminate site soils, watercourses or stormwater drainage systems; containers shall not be overfilled).
- At the Department's Maintenance Facilities, hazardous waste shall be stored in sealed containers constructed of a compatible material and shall be properly labeled in accordance with the Department's [Maintenance Hazardous Waste Manual](#); Chapter 2 *Hazardous Waste Storage*. These types of materials require secondary containment.

### Maintenance:

Periodically inspect the maintenance facility storage site to ensure all requirements are met and to review storage, disposal, and transport procedures.

Waste storage areas shall be kept clean, well-organized, and equipped with ample cleanup supplies as appropriate.

Hazardous spills shall be cleaned up and reported in conformance with the applicable Safety Data Sheets (SDSs) and any instructions included in the Spill Plans.



### C.13.4 Contaminated Soil Management



Figure C.13.4-1 Contaminated Soil Management

#### Description:

These are procedures and practices to minimize or eliminate the discharges of pollutants from contaminated soil/sediment to stormwater drainage systems or watercourses. Certain contaminated soil may be reused under specific conditions allowed the Department by agreements with regulatory agencies such as Cal-EPA DTSC for soil contaminated with aerially deposited lead (ADL).

#### Appropriate Applications:

Contaminated soil/sediment generated during emergency response or other maintenance activities should be collected and managed for reuse, treatment or disposal.

#### Implementation:

- The District HazMat Manager is the Maintenance Division lead for Maintenance HazMat activities. Maintenance staff shall contact the HazMat Manager immediately if wastes are generated or encountered within the Department's Right of Way requiring special HazMat handling procedures.
- Work with the local regulatory agencies to develop options for reuse, treatment, and/or disposal of contaminated soil. Any reuse, treatment and/or disposal of contaminated soils shall be in accordance with Department agreements with the appropriate regulatory agencies.
- Disposal of contaminated soil shall be in accordance with C.13.2 Solid Waste Management BMP or C.13.3 Hazardous Waste Management BMP, depending on soil characteristics.
- Avoid stockpiling contaminated soils or hazardous material.
- Do not stockpile in or near stormwater drainage systems or watercourses.
- If temporary stockpiling is necessary refer to C.17 for proper stockpile procedures:
  - Cover the stockpile with plastic sheeting or tarps; and/or
  - Install a berm or barrier around the stockpile to prevent runoff from leaving the area and to protect from run-on and run-off.
- Take all necessary precautions and preventive measures to prevent the flow of water, including ground water, from mixing with hazardous substances.



**Maintenance:**

- Temporary stockpiles of contaminated soil should be inspected regularly and controls shall be repaired as needed.

### C.13.5 Sanitary/Septic Waste Management



Figure 13.5-1 Sanitary/Septic Waste Management

#### Description:

Sanitary/septic waste management procedures and practices are designed to minimize or eliminate the discharge of sanitary/septic waste materials to storm drain systems or watercourses and from traffic circulation.

#### Appropriate Applications:

Sanitary/septic waste management practices are implemented for all maintenance activities that use portable sanitary/septic waste systems.

#### Implementation:

- Portable sanitary facilities shall be located at least 50 feet away from downstream drainage facilities and watercourses. When subjected to risk of high winds, sanitary facilities shall be secured to prevent overturning.
- Wastewater shall not be discharged (unless the discharge is to a permitted leach field or pond) or buried within the highway right-of-way.
- Ensure the containment of sanitation units (e.g., portable toilets) to prevent pollutant discharges to the storm water drainage system or receiving water.

#### Maintenance:

- Sanitary/septic waste should be discharged to a sanitary sewer or managed by a licensed hauler.
- Sanitary/septic waste storage and the disposal procedures should be managed to prevent non-stormwater discharge.

### C.13.6 Liquid Waste Management



Figure 13.6-1 Liquid Waste Management

#### Description:

Liquid waste management procedures and practices are designed to prevent the discharge of pollutants to stormwater drainage systems or watercourses as a result of the creation, collection or disposal of nonhazardous materials that may be unauthorized non-stormwater discharges.

#### Appropriate Applications:

- Liquid waste management is applicable to maintenance activities that generate any of the following non-hazardous byproducts, residuals, or wastes:
  - Drilling slurries and drilling fluids.
  - Grease-free and oil-free wastewater and rinse water.
  - Dredgings.
  - Other non-stormwater liquid discharges not permitted by separate permits.
- Disposal of some liquid wastes may be subject to specific laws and regulations, or to requirements of other permits secured for the job (e.g., National Pollutant Discharge Elimination System (NPDES) permits, Army Corps permits, Coastal Commission permits, etc.).
- Does not apply to dewatering operations (see C.28 Dewatering Operations), Solid Waste Management (see C.13.2 Solid Waste Management), Hazardous Wastes (see C.8.4 Hazardous Waste Management), or Concrete Slurry Residue (see C.13.7 Concrete Waste Management).
- Does not apply to conditionally exempt non-stormwater discharges permitted by any Caltrans NPDES permit unless the discharge is determined by Caltrans or the SWRCB to be a source of pollutants.
- The authorized non-stormwater discharges include: diverted stream flows, hillside dewatering including slope lateral drainage, uncontaminated pumped groundwater, flows from riparian habitats/wetlands, water from crawl space or basement pumps, swimming pools, uncontaminated groundwater infiltration to separate storm sewers as defined at 40 CFR §35.2005(20), discharges or flows associated with emergency firefighting activities or operations, irrigation water, minor incidental discharges from landscape irrigation, naturally occurring groundwater seepage via a storm drain, non-anthropogenic flows from a naturally occurring steam via a culvert or storm drain, as long as there are

no contributions of anthropogenic runoff, waterline/hydrant flushing, footing drains, potable water sources, air conditioning condensate, minor incidental discharges from lawn watering, rising groundwater, springs, foundation drains and residential car washing.

### Implementation:

- Non-stormwater discharges, unless specifically exempted by the Caltrans NPDES permit, to drainage paths, drain systems and watercourses are prohibited.
- Drilling and sawcutting fluids:
  - Stick-down berms may be used to improve containment.
  - Fluids may be collected by vacuum or other methods.
  - Collected fluids shall be contained and recycled, evaporated or discharged to the sanitary sewer system with approval from the publicly-owned treatment works (POTW).
  - Fluids shall not be discharged to stormwater drainage systems or watercourses.
  - The supervisor shall oversee and enforce proper liquid waste management procedures and practices.
  - Instruct maintenance personnel how to safely differentiate between non-hazardous liquid waste and potential or known hazardous liquid waste.
  - Instruct maintenance personnel that it is unacceptable for any liquid waste to enter any storm drainage structure, waterway, or receiving water.
  - Educate maintenance personnel on liquid waste generating activities, and liquid waste storage and disposal procedures.
  - Hold regular meetings to discuss and reinforce disposal procedures (incorporate into regular tailgate meetings).
  - Verify which non-stormwater discharges are permitted by the Caltrans Statewide NPDES permit; different regions might have different requirements not outlined in this permit. Some listed discharges may be prohibited if Caltrans determines the discharge to be a source of pollutants.
  - Apply the C.15.1, “Vehicle and Equipment Cleaning” BMP for managing wash water and rinse water from vehicle and equipment cleaning operations
- Vacuumed liquid wastes:
  - A visual inspection of water drainage facilities shall be performed prior to cleaning. Caltrans operators are trained to visually inspect for petroleum products, odors, discoloration and other physical evidence of contamination. If chemical contamination is suspected, the operators will stop work and notify the Maintenance Supervisor. The Supervisor will follow existing Caltrans Hazardous Materials Spills procedures and coordinate removal of the contamination with the District Maintenance Hazardous Materials Coordinator.
  - Liquid waste collected in the vacuum trucks may be evaporated or discharged to a Regional Water Quality Control Board approved temporary decanting location in the District. The Maintenance Supervisor shall ensure drain and culvert cleaning crews are aware of approved decanting procedures and the approved decanting location.
- Capturing, Containing, and Disposing Liquid Waste
  - Capture all liquid wastes running off a surface, which has the potential to affect the storm drainage system, such as wash water and rinse water from cleaning walls or pavement.

- Do not allow liquid wastes to flow or discharge uncontrolled. Use temporary dikes or berms to intercept flows and direct them to a containment area or device for capture.
- If the liquid waste is sediment laden, use a sediment trap (see SC-3, “Sediment Trap”) for capturing and treating the liquid waste stream, or capture in a containment device and allow sediment to settle.
- Liquid wastes generated as part of an operational procedure, such as water laden material and mud, shall be contained and not allowed to flow into drainage channels or receiving waters prior to treatment.
- Contain liquid wastes in a controlled area, such as a holding pit, sediment basin, roll-off bin, or portable tank.
- Containment devices must be structurally sound and leak free.
- Containment devices must be of sufficient quantity or volume to completely contain the liquid wastes generated.
- Take precautions to avoid spills or accidental releases of contained liquid wastes. Apply the education measures and spill response procedures outlined in C.13.1, “Spill Prevention and Control.”
- Do not locate containment areas or devices where accidental release of the contained liquid can threaten health or safety, or discharge to water bodies, channels, or storm drains.
- Typical disposal of liquid waste method is to dewater the contained liquid waste, using procedures such as described in C.28, “Dewatering Operations”, and C.4.6, “Sediment Trap”; and dispose of resulting solids per C.13.2, “Solid Waste Management”.
- For off-site disposal the method of disposal for some liquid wastes may be prescribed in Waste Discharge Requirements, local agency discharge permits, etc., and may be defined elsewhere in state and federal regulations.
- Liquid wastes may require testing and certification whether it is hazardous or not before a disposal method can be determined.
- For disposal of hazardous waste, see C.13.4, “Hazardous Waste Management.”
- If necessary, further treat liquid wastes prior to disposal. Treatment may include, though is not limited to, sedimentation, filtration, and chemical neutralization.
- Tunnel cleaning:
  - Discharge to stormwater drainage systems or watercourses from tunnel maintenance is prohibited
  - Storm drain inlets and systems shall be adequately protected from liquid waste discharges (see C.5 Storm Drain Inlet Protection BMP).
  - Nonhazardous spent solvents shall be captured and reused, recycled or disposed in accordance with federal, state and local requirements.
  - Refer to the C.14 Materials Handling BMPs for appropriate handling and storage of liquids at maintenance activity sites.
  - Refer to the C.13.7 Concrete Waste Management BMP for appropriate management of concrete waste.

**Maintenance:**

- Supervisors should review job sites to ensure appropriate practices are being employed.
- Remove deposited solids in containment areas and capturing devices as needed, and at the completion of the task. Dispose of any solids as described in C.13..2, “Solid Waste Management.”
- Inspect containment areas and capturing devices frequently for damage, and repair as needed.

### C.13.7 Concrete Waste Management



Figure 13.7-1 Concrete Waste Management

#### Description:

Concrete waste management procedures and practices are designed to ensure that concrete wastes are properly handled and eliminate the discharge of concrete waste to stormwater drainage systems or watercourses.

#### Appropriate Applications:

Concrete waste can be generated in various maintenance activities including Curb and Sidewalk Repair, Mudjacking and Drilling, Drain and Culvert Maintenance, Drainage Ditch and Channel Maintenance, Public Facilities, Sawcutting for Loop Installation, Sign Repair and Maintenance, Median Barrier and Guard Rail Repair, and Building and Grounds Maintenance.

#### Implementation:

- Contracts for concrete providers require contractors to appropriately manage any concrete waste and prohibit non-stormwater discharges generated at the job site.
- Portland cement concrete waste shall not be allowed to enter stormwater drainage or watercourses.
- Concrete waste from grout pumping operations shall be contained.
- Concrete residue should be collected by vacuum or shovel for proper disposal.
- Liquid waste can be contained in a bucket or drum with a tight-fitting lid for transport and approved off-site disposal. Plastic bags may be used if nothing else is available. Avoid breaking the bags by double-bagging and filling the bags to about one-fifth of their capacity. Allow solids to settle and recycle or dispose of in accordance with the C.13.2 Solid Waste Management BMP. The liquid waste may be evaporated. Decanted liquid waste shall be discharged to sanitary sewer only with the POTW's approval. Decanted liquid waste may also be removed for disposal as hazardous waste. Refer to C.13.3 Hazardous Waste Management BMP.
- A temporary concrete washout facility may be constructed at the maintenance activity area. Below-grade concrete washout facilities are preferred. Above-grade facilities are used if excavation is not practical. Designated washout areas should be located at least 50 feet away from drainage facilities.



- Below-grade facilities consist of a pit excavated away from watercourses. Above-grade washout facilities should be bermed using sandbags or straw bales. Local requirements and other environmental restrictions should be reviewed prior to placing concrete waste on the ground. Plastic lining material shall be a minimum of 10-mil polyethylene sheeting and shall be free of holes, tears or other defects that compromise the impermeability of the material. The base shall be prepared free of rocks or other debris that may cause tears or holes in the plastic lining material.
- The supervisor or the designee shall monitor the concrete working tasks, such as saw cutting, coring, grinding and grooving to ensure that concrete waste is collected and disposed of properly.
- Residue from sawcutting, coring and grinding operations shall be picked up by means of a vacuum device. Residue shall not be allowed to flow across the pavement and shall not be left on the surface of the pavement.

## C.14 Materials Handling

Materials handling consists of implementing procedural and structural BMPs for handling, storing and using maintenance materials in a manner that prevents the release of those materials into stormwater. These practices include:

- C.14.1 Material Delivery and Storage
- C.14.2 Material Use
- C.14.3 Material Loading and Unloading

### C.14.1 Material Delivery and Storage



Figure C.14.1-1 Material Delivery and Storage

#### Description:

Material delivery and storage procedures and practices are designed for the proper handling and storage of materials at the maintenance facility. These procedures and practices minimize or eliminate the discharge of these materials to stormwater drainage systems or watercourses.

#### Appropriate Applications:

- These procedures are implemented at maintenance facilities involved in the delivery and storage of aggregate, pesticides, fertilizers, detergents, plaster, petroleum products, asphalt and concrete components, concrete compounds or other materials that may be detrimental if released to stormwater drainage systems or watercourses.
- Space limitation may preclude indoor storage. Storage sheds must meet building & fire code requirements.
- Refer to C.14.2 Material Use BMP and C.17 Stockpile Management BMP for procedures that apply to any materials that are assembled for use at a maintenance activity site.

#### Implementation:

- Hazardous materials in liquid storage shall have secondary containment that will provide within its boundary:
  - Spill containment volume of 10% of the total volume of all containers, or 100% of the capacity of the largest container, whichever is greater.
  - Impervious containment and compatibility to the materials in storage.
- Secondary containment volume outdoors should account for precipitation from a 24-hour, 25-year storm event, and should be maintained free of rainwater and spills at all times.
- Rainwater in containment facilities should be inspected prior to discharge. Drain valves should remain closed except to release clean rainwater.
- Personnel at maintenance facilities shall be trained to ensure that materials are properly handled and stored.
- Separation should be provided between stored containers and materials to allow for spill cleanup and emergency response cleanup as well as avoid hazardous reactions upon contact

- To provide protection from rain, bagged and boxed materials stored outdoors shall be stored on pallets throughout the rainy season and covered prior to rain events.
- Storage areas shall be kept clean, well-organized and equipped with cleanup supplies for the materials being stored. Refer to C.13.1 Spill Prevention and Control on storage of non-hazardous liquid materials.
- Treated timber shall not be stored directly on the ground and shall be covered. Treated timber shall not be used to elevate storage of equipment and/or materials.
- Store liquid containers on shelves with containment trays to avoid spills while handling.

#### **Maintenance:**

- Storage areas shall be kept clean, well-organized, and equipped with ample clean-up supplies as appropriate for the materials being stored.
- Perimeter controls, containment structures, covers, and liners shall be repaired or replaced as needed to maintain proper function.
- Inspect storage areas before and after rainfall events, and at least weekly where hazardous materials containers are stored. Collect and place into drums any spills or accumulated rainwater if contaminants are suspected.
- Keep an accurate, up-to-date inventory of material delivered and stored on-site.

## C.14.2 Material Use



Figure C.14.2-1 Material Use

### Description:

Material use procedures and practices are used at maintenance facilities and maintenance activity sites to prevent the discharge of materials to stormwater drainage systems or watercourses.

### Appropriate Applications:

These procedures are implemented at maintenance facilities and at maintenance activity sites where pesticides, fertilizers, detergents, plaster, petroleum products, asphalt and concrete components, concrete compounds and other material that may be detrimental if released to the environment are used or prepared.

### Implementation:

- Contract agreements with haulers who supply materials to maintenance activity sites should require them to supply materials in accordance with the requirements of this BMP.
- Latex paint and paint cans, used brushes, rags, absorbent materials and drop cloths shall be disposed of in accordance with federal, state and local requirements.
- Do not remove the original product label from a container as it contains important spill cleanup and disposal information. Make copies of the label information or safety data sheet (SDS) if needed. Use the entire product before disposing of the container. Appropriately label all secondary containers.
- Mix paint in a containment area. Do not clean paintbrushes or rinse paint containers where rinseate may discharge into a street, gutter, stormwater drainage systems or watercourses. Rinseate from latex paint cleaning shall be disposed of properly. Empty paint cans shall be dry prior to disposal as solid waste. See C.13.6 Liquid Waste Management BMP and C.13.3 Hazardous Waste Management BMP.
- Paint should be loaded into spray equipment at a maintenance facility. Nearby drain inlets should be protected at maintenance facilities and at maintenance activity site.

- Use materials only where and when needed to complete the maintenance activity. Consider the use of C.21 Safer Alternative Products when possible. Reduce or eliminate use of hazardous materials on site when possible.
- Dispose of any paint thinners, residue and sludge(s), that cannot be recycled, as hazardous waste.
- For water-based paint, clean brushes to the extent practical, and rinse to a drain leading to a sanitary sewer where permitted, or into a concrete washout pit. For oil-based paints, clean brushes to the extent practical and filter and reuse thinners and solvents.
- When loading and mixing pesticides, control water use to reduce potential for unpermitted non-stormwater discharges (e.g., provide a positive shutoff type of hose nozzle).
- Do not over-apply fertilizers and pesticides. Prepare only the amount needed. Strictly follow the recommended usage instructions. Apply surface dressings in smaller applications, as opposed to large applications, to allow time for it to work in and to avoid excess materials being carried off-site by runoff.
- Avoid exposing applied materials to rainfall and runoff unless sufficient time has been allowed for them to dry. Application of herbicides and pesticides shall be performed by a licensed applicator.
- Keep a supply of spill cleanup material near material use areas. Train employees in spill cleanup procedures. See C.13.1 Spill Prevention and Control when using liquid materials in activity sites and facilities.
- Secure loads and cover loose materials in open-bed trucks during hauling to activity sites.
- Truck beds should be inspected after the completion of material delivery to avoid depositing materials on the roadway.
- Use proper loading and unloading techniques to prevent spills.

### C.14.3 Material Loading and Unloading



Figure C.14.3-1 Material Loading and Unloading

#### Description:

The loading/unloading of materials usually takes place outside on docks or terminals; therefore, materials spilled, leaked, or lost during loading/unloading may collect in the soil or on other surfaces and have the potential to be carried away by stormwater runoff or when the area is cleaned.

#### Appropriate Applications:

Loading and unloading of material may include package products, barrels, and bulk products. Implementation of the following protocols will prevent or reduce the discharge of pollutants to stormwater from outdoor loading/unloading of materials. Aside from materials, stormwater may wash pollutants from machinery used to unload or move materials.

#### Implementation:

- Develop an operations plan that describes procedures for loading and/or unloading.
- Do not conduct loading and unloading during wet weather, whenever possible.
- Designate loading/unloading area to prevent stormwater run-on which would include grading or berming the area, and positioning roof downspouts so they direct stormwater away from the loading/unloading areas.
- Cover designated loading/unloading areas to reduce exposure of materials to rain. A seal or door skirt between delivery vehicles and building can reduce or prevent exposure to rain.
- If feasible, load and unload all materials and equipment in covered areas such as building overhangs at loading docks. Load/unload only at designated loading areas.
- Use drip pans underneath hose and pipe connections and other leak-prone spots during liquid transfer operations, and when making and breaking connections. Several drip pans should be stored in a covered location near the liquid transfer area so that they are always available yet protected from precipitation when not in use. Drip pans must be cleaned periodically, and drip collected materials must be disposed of properly.
- Pave loading areas with concrete instead of asphalt. Avoid placing storm drains in the area. Grade and/or berm the loading/unloading area to a drain that is connected to a dead-end sump.
- Check loading and unloading equipment regularly for leaks, including valves, pumps, flanges and connections. Look for dust or fumes during loading or unloading operations.



- Train maintenance personnel on proper spill containment and cleanup. Personnel trained in spill containment and cleanup should be present during the loading/ unloading. Train maintenance personnel in proper handling techniques during liquid transfers to avoid spills.
- Make sure equipment operators are properly trained on loading and unloading procedures.
- Have spill cleanup materials readily available and in a known location. Cleanup spills immediately and use dry methods if possible. Properly dispose of spill cleanup material.
- Space, material characteristics and/or time limitations may preclude all transfers from being performed indoors or under cover.

### **Maintenance:**

- Conduct regular inspections and make repairs as necessary. The frequency of repairs will depend on the age of the facility.
- Check loading and unloading equipment regularly for leaks.
- Regular broom dry-sweeping of area.
- Conduct major clean-out of loading and unloading area and sumps prior to October 1 of each year.

## C.15 Vehicle and Equipment Cleaning

Vehicle and equipment operations, procedures and practices are designed to minimize or eliminate the discharge of pollutants from vehicle and equipment cleaning, fueling and maintenance operations to stormwater drainage systems or watercourses. These include the following.

- C.15.1 Vehicle and Equipment Cleaning
- C.15.2 Vehicle and Equipment Fueling
- C.15.3 Vehicle and Equipment Maintenance

### C.15.1 Vehicle and Equipment Cleaning



Figure C.15-1 Vehicle and Equipment Cleaning

#### Description:

Discharges to stormwater drainage systems or watercourses from vehicle and equipment cleaning are prohibited. Vehicle and equipment cleaning procedures and practices are used to eliminate the discharge of pollutants from vehicle and equipment cleaning operations to stormwater drainage systems or watercourses.

#### Appropriate Applications:

- These procedures apply whenever vehicle and equipment cleaning is performed.
- Waste generated during concrete washout must be managed in accordance with the C.13.7 Concrete Waste Management BMP. Non-stormwater discharges of concrete washout are prohibited.

#### Implementation:

- Contractual provisions require contractors to use cleaning practices consistent with the requirements of this BMP when working at maintenance activity sites.
- When using solvents for cleaning vehicles and equipment, used solvents and by-products shall be captured and reused, recycled or disposed of according to the requirements of the C.13.6 Liquid Waste Management BMP or C.13.3 Hazardous Waste Management BMP, depending on waste characteristics. Minimize use of solvents.
- When possible, truck beds should be cleaned using a dry cleanup technique (sweep up or shovel out).
- Vehicle and equipment rinsing and/or washing shall occur only at designated areas.
  - When rinsing areas at a maintenance facility, or in the field, vehicle and equipment rinse water should be discharged to a sanitary sewer. If no connection to the sanitary sewer is available, water should be contained for percolation (if preapproved by the RWQCB) or evaporation, drying away from storm drain inlets or watercourses.
  - Designated equipment wash areas should discharge to a sanitary sewer, recycle system or other approved discharge system.
  - Concrete washout areas are described under C.13.7 Concrete Waste Management BMP.
- Minimize water use to reduce potential for unpermitted non-stormwater discharges (e.g., provide a positive shutoff type of hose nozzle).

- Post signs for rinsing and wash areas that identify the allowable cleaning methods for the location and discharge prohibitions.

**Maintenance:**

- Regularly inspect and maintain the designated rinsing areas, facility wash racks, designated cleaning areas, wash pads, clarifiers, oil-water separators, sumps and sediment traps. Follow manufacturer's instructions including regular cleaning and repair by contract.

## C.15.2 Vehicle and Equipment Fueling



Figure 15.2-1 Vehicle and Equipment Fueling

### Description:

Vehicle and equipment fueling procedures and practices are designed to minimize or eliminate the discharge of fuel spills and leaks into stormwater drainage systems or watercourses during equipment fueling and the bulk delivery of fuel.

### Appropriate Applications:

These procedures apply at all maintenance sites where vehicle and equipment fueling occurs.

### Implementation:

#### Bulk Fuel Delivery

- All aboveground and underground storage tanks shall be equipped with automatic overfill shutoff valves.
- Implement C.13.1 Spill Prevention and Control BMP to prevent spillage.
- Implement C.5 Storm Drain Inlet Protection BMP to prevent non-stormwater discharges to the stormwater drainage systems and watercourses.

#### Fueling Area Maintenance

- Label drains at fuel dispensing areas to indicate if they discharge to the storm drain or to the sewer.
- Storm drain inlets may be temporarily covered with spill pads and/or mats during fueling operations.
- Absorbent spill cleanup materials or drip pans shall be stored in fueling and maintenance areas and used materials shall be disposed in accordance with C.13.3 Hazardous Waste Management BMP.
- Immediately clean up leaks and drips.
- Hosing off the fueling area is prohibited. Dry shop clean up practices should be used.
- Manage wastes to reduce adverse impacts on stormwater quality (see C.13.2 Solid Waste Management BMP and C.13.3 Hazardous Waste Management BMP). Fueling areas should be kept free of litter and debris that might become contaminated with petroleum products.
- Maintain and implement a current spill response plan for fueling operations.
- Protect fueling areas with berms or dikes to prevent run-on, run-off and to contain spills.
- Portable fuel canisters should be kept in a flammable cabinet when not in use.

### Refueling Practices

- Nozzles used at dedicated fueling areas shall be equipped with an automatic shutoff.
- Warnings against “topping off” fuel tanks should be posted at fuel dispensers.
- Fueling operations shall not be left unattended.
- Fueling in the field shall not be performed near unprotected drainage facilities or watercourses. See C.13.1 Spill Prevention and Control BMP and C.5 Storm Drain Inlet Protection BMP for pollution prevention and response requirements.

### Maintenance:

- Inspect fueling facilities daily and correct deficiencies.
- Keep a supply of spill cleanup materials on site.

### C.15.3 Vehicle and Equipment Maintenance



Figure 15.3-1 Vehicle and Equipment Maintenance

#### Description:

Vehicle and equipment maintenance procedures and practices are designed to minimize or eliminate the discharge of pollutants to stormwater drainage systems or watercourses from vehicle and equipment maintenance.

#### Appropriate Applications:

- These procedures are applied where equipment and vehicles are stored or repaired.
- These procedures should be implemented to avoid prohibited discharges to the stormwater drainage system of fuel, oil, hydraulic fluid, brake fluid, antifreeze and wiper fluid.

#### Implementation:

##### Indoor Maintenance

- Maintenance should be performed in covered or indoor maintenance areas to prevent potential pollutants from being introduced into stormwater drainage systems.

##### Field or Outdoor Maintenance

- Drip pans or absorbent materials shall be used during vehicle and equipment maintenance work that involves fluids.
- See C.13.1 Spill Prevention and Control BMP for pollution prevention and response measures.
- See C.13.4 Contaminated Soil Management BMP to address any contaminated soil resulting from vehicle or equipment repair.
- Use dry methods (e.g., dry rags, vacuuming or sweeping) for cleaning associated with maintenance in outdoor areas.
- Dedicated maintenance areas shall be on level ground and protected from storm water run-on and runoff and shall be located at least 50 feet from downstream drainage facilities and receiving waters.
- Protect maintenance areas with berms or dikes to prevent run-on, runoff, and to contain spills.



**General Maintenance (in the field or in the yard)**

- Vehicles and equipment shall be inspected for leaks on each day of use. Leaks should be repaired immediately; problematic vehicles or equipment shall be removed from the maintenance activity site.
- All parts washing should be performed in designated areas. Do not wash parts where wash waste cannot be captured. Use self-contained sinks or tanks when working with solvents.
- Non-stormwater discharges into stormwater drainage systems or watercourses are prohibited.
- Wastes should be collected and reused, recycled, removed or disposed of in accordance with the C.13.3 Hazardous Waste Management BMP.

**Maintenance:**

- Inspect areas following vehicle and equipment maintenance activities to ensure there is no residual contamination that might impact stormwater. Clean areas as needed using dry methods, (e.g., sweeping or vacuuming).
- Maintain waste fluid containers in leak-proof condition.
- Inspect equipment for damaged hoses and leaky gaskets. Repair or replace as necessary.

## C.16 Paving Operations Procedures



Figure C.16. Paving operations procedures

### Description:

Paving operations procedures are designed to minimize pollution of stormwater runoff during paving, surfacing, resurfacing or sawcutting operations.

### Appropriate Applications:

These procedures are implemented where paving, surfacing, resurfacing or sawcutting may pollute stormwater runoff or discharge to stormwater drainage systems or watercourses.

Shoulder backing placed within 100 feet measured horizontally from a culvert, watercourse, or bridge must not contain reclaimed asphalt concrete.

### Implementation:

Protect drainage inlet structures and manholes during paving operations including when seal coat, tack coat, slurry seal or fog seal is applied. Seal coat, tack coat, slurry seal or fog seal should not be applied if rainfall is predicted to occur during the application or curing period.

When using asphalt release agents (e.g., citrus, soy-based or diesel) for cleaning and coating of equipment and tools, all products and by-products shall be captured and reused, recycled or disposed in accordance with the requirements of the Section C.13.3 Hazardous Waste Management BMP. Asphalt release agents shall not be discharged to the stormwater drainage systems or watercourses.

Clean pavers over absorbent pads, drip pans, plastic sheeting or other materials to collect residual cleaning wastes. Section C.5 Storm Drain Inlet Protection BMP should be used during cleaning to prevent any unauthorized non-stormwater discharge. Dispose of removed material in accordance with the Section C.13.3 Hazardous Waste Management BMP.

Pick up and reuse, recycle or dispose of cured material in accordance with the Section C.13.2 Solid Waste Management BMP. Diesel fuel used in kettle cleaning shall be contained and reused, recycled or disposed of in accordance with the Section C.13.3 Hazardous Waste Management BMP.

Prevent water used to clean emulsion kettles from discharging into stormwater drainage systems or watercourses (see Section C.5 Storm Drain Inlet Protection BMP). Recycle products where possible to avoid discharge.

The primary concern with the AC reuse options is that contaminants (i.e., pH, metals, petroleum hydrocarbons) may threaten groundwater and/or surface water bodies. In the MOU with the California Department of Fish and Wildlife, the Department may use AC chunks and pieces in embankment, and AC grindings in shoulder backing when these materials are placed where they cannot enter the waters of the State (see SWMP Section. 6.8).

The North Coast RWQCB require a characterization study and review by the Regional Board to determine if the reuse of AC grindings does not have the potential to degrade water quality (see SWMP Section. 6.8).

The San Francisco Bay RWQCB reviews on a case by case basis the reuse of AC or PCC grindings as yard cover or in embankments where the material is exposed at the surface (see SWMP Section. 6.8).

### **Maintenance:**

Maintain machinery regularly to minimize leaks and drips.

## C.17 Stockpile Management



Figure C-17-1 Stockpile Management

### Description:

Stockpile management procedures and practices are designed to reduce or eliminate pollution of stormwater from stockpiles of various type of materials.

- Appropriate Applications: Stockpile management procedures are used for stockpiles of the following materials:
  - contaminated and uncontaminated soil
  - vegetative waste
  - paving materials such as portland cement concrete rubble, asphalt concrete, asphalt concrete rubble, aggregate base or subbase, and cold mix
  - materials removed from drains, ditches and culverts
  - pressure treated wood with copper, chromium, and arsenic or ammonical, copper, zinc, and arsenate placed on pallets at all times
  - any other material or waste that could impact water quality (e.g., snow haul in the Lahontan Region)

### Implementation:

- All stockpiles shall be stabilized, or protected with temporary linear sediment or perimeter barrier, and, at the onset of precipitation, the following stockpile materials shall be covered with plastic or comparable impermeable sheeting:
  - Stockpiles of "cold mix" asphalt (i.e., pre-mixed aggregate and asphalt binder) shall be covered, placed on impermeable surface and protected from run-on and run-off. Any deviation from this BMP for "cold mix" shall be coordinated with the RWQCB.
  - Stockpiles of Portland cement concrete rubble, asphalt concrete, asphalt concrete rubble, shall be covered or protected with a temporary perimeter sediment barrier. Bagged materials should be placed on pallets and under cover.

- Pressure treated wood with copper, chromium, and arsenic or ammonical, copper, zinc, and arsenate shall be covered if stored outdoors and elevated or placed on pallets to avoid runoff/runoff.
- Aggregate base or subbase, soil, and abrasives used for winter road operations if stockpiled outdoors should be covered, or if not operationally feasible, use effective perimeter sediment barriers found in Sections C.4 Sediment Control and C.6 Concentrated Flow Conveyance Controls.
- Locate stockpiles a minimum of 50 feet away from concentrated flows of stormwater, watercourses drainage systems, or inlets. Implement drainage inlet protection as applicable.
- Divert stormwater run-on away from stockpiles. See Section C.6.2, Ditches, Berms, Dikes and Swales BMP.
- Wind erosion control practices shall be implemented on stockpile material. See Section C.11, Wind Erosion Control BMP.
- Manage stockpiles of contaminated soil in accordance with the Section C.13.4, Contaminated Soil Management BMP.
- Monitor stockpiles accessible to the public for illegal dumping of solid waste and animal carcass. Remove and dispose illegally dumped waste materials as appropriate
- Permanent perimeter barrier. Implementation of permanent perimeter barrier may be allowed if the following conditions are satisfied:
  - The materials stored are those that will create sediment laden runoff only such as sand, soil and aggregate.
  - The barrier or berm is compacted and stabilized with sufficient base and height to contain the stockpile materials and runoff within the perimeter.
  - The downstream exit of runoff shall have adequate sediment control BMPs found in Section C.4 installed to effectively contain or control sediment laden runoff.
  - The permanent perimeter barrier shall enclose the storage site with entrance for vehicle and equipment. The storage site shall reduce the tracking of sediment onto public roads by vehicles and equipment at the point of entrance/exit using C.12 Sediment Tracking Controls.
  - Allow sufficient clearance from the stockpile to allow equipment operations without damaging the barrier,
  - Limit the size of stockpiles to avoid slumps and or slope failure.

### Maintenance:

- Discharge from stockpiles occur when linear barriers and covers are improperly maintained. Repair and/or replace perimeter controls and covers as necessary to keep them functioning properly. Sediment shall be removed when sediment accumulation reaches one-third (1/3) of the barrier height.
- Permanent perimeter barriers and downstream exit BMPs shall be inspected, cleaned or repaired for signs of failure, deterioration, sediment accumulation or instability.
- Maintain good housekeeping practices inside the perimeter. Without source control containment, the stockpile materials could spread unnecessarily within the perimeter by runoff, wind erosion or equipment operations.

- Maintain separation of multiple stockpiles within the perimeter to allow sufficient clearance for vehicle or equipment access.
- Clean any entrance/exit sediment tracking control regularly to avoid sediment build up and roadway tracking.

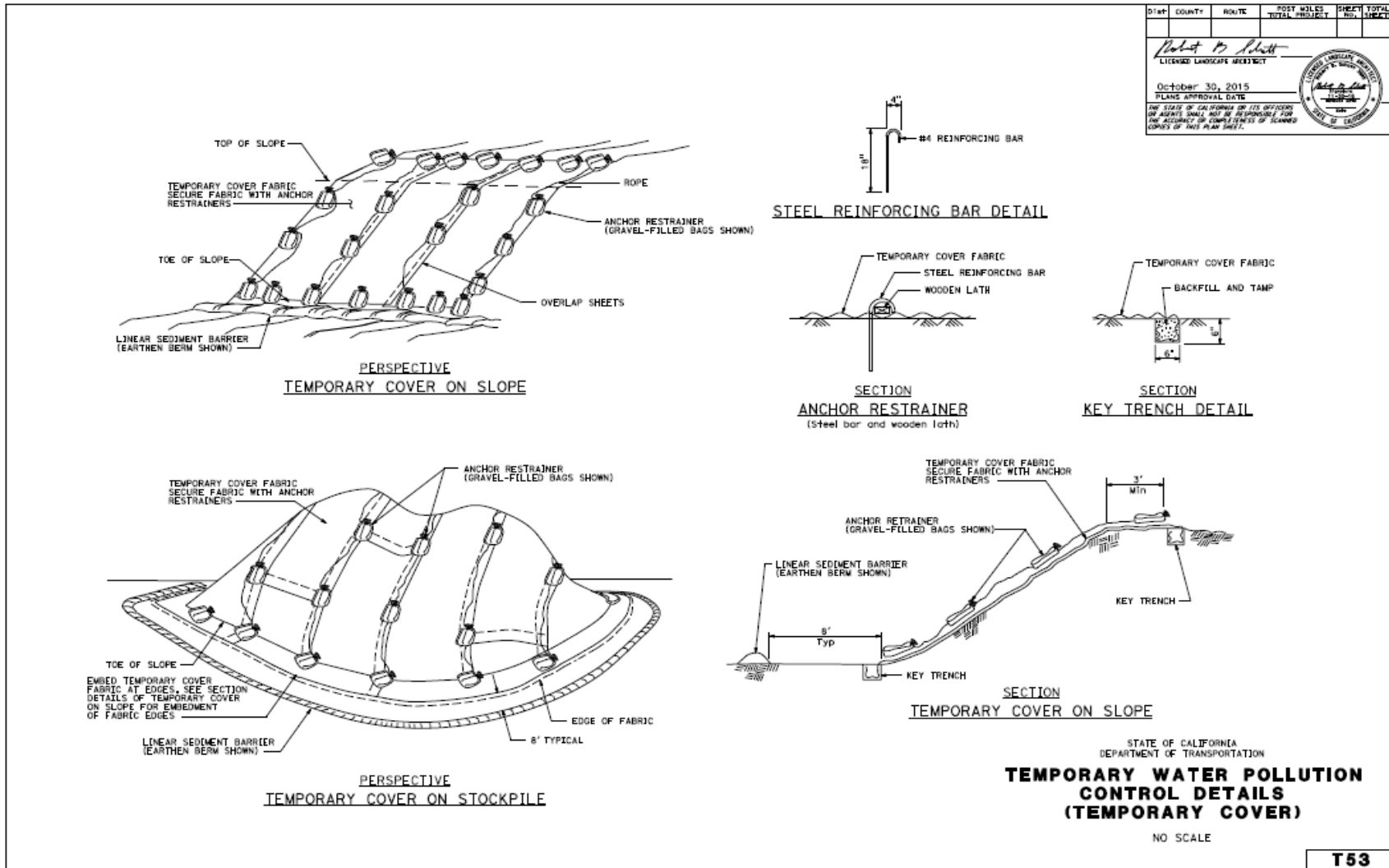

2015 STANDARD PLAN T53

**T53**

Figure C-17-2. Temporary Stockpile Cover



## C.18 Water Conservation Practices

### Description:

Water conservation practices minimize water use during a maintenance activity to avoid causing erosion and/or the transport of pollutants into the drainage system and watercourses. Non-stormwater discharges to stormwater drainage systems and watercourses are prohibited unless the discharge is authorized by a separate National Pollutant Discharge Elimination System (NPDES) permit, exempted or conditionally exempt as provided in the Caltrans NPDES Permit.

### Appropriate Applications:

- All maintenance activities should practice water conservation.
- Unpermitted non-stormwater discharges are prohibited.

### Implementation:

- Keep water application equipment in good working condition.
- Avoid using water to clean maintenance areas. Use dry cleanup methods where practical. Sweep paved areas.
- Use the minimum amount of water needed to complete each maintenance activity.
- In periods of recurring and prolonged drought, District Maintenance employees must act immediately to reduce water use by 50 percent. The following drought response actions shall be followed:
  - Cease all landscape irrigation in severe water shortage areas as defined by the California Department of Public Health and all irrigation of turf grasses and lawns at all facilities and roadsides (i.e. State Roadside Rest Areas, Maintenance Stations, Truck Weight Inspection Facilities, etc.).
  - Revise irrigation controller schedules so that all operations occur during the night, where possible. Do not allow water to run-off onto the pavement. Respond to alerts of leaks, errant sprinklers, and breaks generated by "smart" irrigation controllers within 24-hours.
  - Replace inefficient irrigation and plumbing components with water efficient components.
  - Use non-potable water for field operations where feasible.
  - Apply mulch and reduce pruning of trees and shrubs (except when addressing safety issues) to reduce water loss through evaporation from the soil.
  - Eliminate the washing of State vehicles, except where it would present a potential health and safety issue to the driver or traveling public.
  - Coordinate closely with local water purveyors to determine local drought conditions, which may require additional reductions and actions, to comply with all local conservation plans and voluntary/mandatory rationing programs. Identify opportunities for staff training of water conservation concepts offered by local water purveyors or irrigation material suppliers, and manufacturers. Inform the public of Caltrans drought actions, by installing signage to identify areas irrigated with non-potable water.

### Maintenance:

- Check, repair, and adjust irrigation controllers for optimum operations. Continue to maintain irrigation systems in good repair and make adjustments as needed for proper application of water.

## C.19 Potable Water/Irrigation

### Description:

In accordance with the SWMP, some non-stormwater discharges are conditionally exempt by the Caltrans NPDES Permit. The conditionally exempt non-stormwater discharges include such discharges as irrigation water, potable water sources and water from line and hydrant flushing. This BMP is intended to reduce the possibility for the discharge of potential pollutants associated with conditionally exempt discharges from irrigation systems, planned and unplanned discharges from potable water sources and water line or hydrant flushing.

### Appropriate Applications:

This BMP should be implemented on a site-specific basis whenever the above activities or discharges occur.

### Implementation:

- When possible, flushed water should be applied for landscaping purposes.
- Shut off the water source to isolate a broken line, sprinkler or valve as soon as possible to minimize the loss of water.
- Repair broken water lines as soon as possible.
- Protect downstream stormwater drainage systems and watercourses from water pumped or bailed from trenches excavated to repair water lines.
- Manage irrigation systems to ensure the appropriate amount of water is used and runoff is minimized.
- If dewatering could result in sediment-laden discharges, the *Field Guide to Construction Site Dewatering* should be reviewed and applicable BMPs applied prior to discharging offsite as noted in C.28 Stormwater Dewatering Operations (Temporary Pumping Operations).

## C.20 Storm Drain Stenciling



Figure C.20.1. Stenciled Storm Drain

### Description:

Stenciled messages at storm drain inlets are intended to educate the public about stormwater runoff pollution. Where required, warnings prohibiting discharges to storm drains should be placed near inlet structures.

### Appropriate Applications:

Storm drain stenciling is approved for park-and-ride lots, safety roadside rest areas, vista points, commercial vehicle enforcement facilities and on the Department's roads and highways, legally accessible by the public, that traverse through cities, towns, and communities with populations 10,000 or more, or if the area is covered by a MS4 permit. Stenciling is not required in areas where pedestrians are prohibited.

### Implementation:

Warnings to discourage illegal discharges should be stenciled onto or adjacent to drain inlets where appropriate. The goal is to increase public awareness of how rainfall runoff can carry litter, automotive fluids, motor oil and other contaminants into waterways.

The design and materials used on storm drain stenciling shall conform to approved materials in the current State of California, Department of Transportation, Standard Plans and Specifications.

### Maintenance:

Stenciling should be inspected and replaced when unreadable or removed.

## C.21 Safer Alternative Products

### Description:

A variety of products that may be harmful to the environment if they come into contact with surface waters are used in maintenance facilities and activities. In some cases, a less harmful product that serves the same purpose can replace a harmful product. The less harmful product is referred to as a safer alternative product. The primary purpose of using safer alternative products is to reduce the potential for the discharge of toxic products to drainage paths, stormwater drainage systems or watercourses.

### Appropriate Applications:

Safer alternative products should be considered for all maintenance activities. For example, when safer alternative products exist for cleaning products, paints, herbicides, automotive products and fertilizers, they should be used where practical and effective. Alternative products may not be available, effective or cost effective in every situation.

### Implementation:

Create awareness among employees regarding the benefits of safer alternative products. Safer alternative product awareness will be incorporated into the Maintenance Division stormwater staff training program. For example, the use of lower phosphate detergents where applicable at facilities and the use of water based cleaners versus halogenated solvents (cleaning fluids).

The materials used on Maintenance activities shall conform to approved materials in the current Standard Specifications and special provisions. The Department's Translab has an established testing protocol for product review and testing before a material becoming a standard material for use. For example, the Standard Specifications include approved asphalt mixtures and thermoplastic striping materials.

The use of a safer alternative product may still result in the discharge of harmful materials to drainage paths, stormwater drainage systems or watercourses. All products are to be used in accordance with manufacturers' recommendations.

## C.22 Drainage Facilities

These BMPs address the maintenance of drainage facilities to reduce the potential for pollutant discharge. Drainage Facilities BMPs include:

- C.22.1 Baseline Storm Water Drainage Facilities Inspection and Cleaning BMP
- C.22.2 Enhanced Storm Drain Inlet Inspection and Cleaning Program BMP
- C.22.3 Illegal Connection and Illicit Discharge (IC/ID)
- C.22.4 Illegal Spill Discharge Control

### C.22.1 Baseline Storm Water Drainage Facilities Inspection and Cleaning



Figure C.22.1-1 Baseline Stormwater Drainage Facilities Inspection and Cleaning

#### Description:

Culverts, ditches, gutters, underdrains, horizontal drains and downdrains require inspection and cleaning to prevent flooding and to provide for sufficient hydraulic capacity.

#### Appropriate Applications:

These procedures are applicable to maintenance personnel who conduct stormwater drainage system facilities inspection and cleaning. BMP implementation will depend on traffic, weather, available resources, safety conditions and access to stormwater drainage systems. Inspect all urban drainage inlets and catch basins a minimum of once per year.

#### Implementation:

- Inspect culverts, ditches, gutters, underdrains, horizontal drains, downdrains and outlets annually and as needed during the winter season to determine if cleaning is required or if damage has occurred.
- Caltrans will inspect storm drains annually during pre-rainy season periods and prioritize the cleaning of storm drains based on the following criteria:
  - Priority 1: Storm drains on highway segments in areas prone to erosion that are within Environmentally Sensitive Areas (ESAs)
  - Priority 2: Storm drains on highway segments in ESAs
  - Priority 3: Storm drains on highway segments in areas prone to erosion

Environmentally Sensitive Areas include:

- Areas that discharge to ASBS
- Areas that discharge to or are within 200 feet of a CWA Section 303(d) listed water bodies that are impaired for a pollutant that is known to be or likely to be discharged from Caltrans facilities or right of way
- Areas where discharges are subject to a TMDL for a pollutant that is known to be or likely to be discharged from Caltrans facilities or right of way
- Known “hot spot” areas of pollution accumulation as identified by Maintenance personnel, complaints and others.

- Impaired waterbodies.
- District maps and databases have been developed identifying areas prone to erosion and Environmentally Sensitive Areas.
- Storm drains that do not meet one or more of the above criteria will be assigned lower priorities for cleaning than those drains that do meet one or more of the above criteria. Type of drainage facility (e.g., self-cleaning drop inlets, catch basins, trash screen, etc.) will also be considered when prioritizing a drain for cleaning.
- Inspect ditches and gutters to maintain sufficient hydraulic capacity. Schedule routine ditch-cleaning activities designed to maintain sufficient hydraulic capacity of ditches prior to the rainy season.
- When cleaning drainage ditches below cut slopes or steep slopes, avoid cutting the toe of the slope. This can also prevent damage to the ditch.
- Water used and the material generated during drainage facility cleaning should be collected and managed per the requirements of C.13.2 Solid Waste Management and C.13.6 Liquid Waste Management BMPs.
- Where waterways are affected, coordinate maintenance activities with the appropriate regulatory agency.
- Temporary stockpiles of removed material should be managed per the requirements of C.17 Stockpile Management BMP.
- The Maintenance Supervisors in charge of the activity will provide vacuum truck operators with written instructions identifying Regional Board approved decanting sites.
- Maintenance Supervisors will work with the District Maintenance Storm Water Coordinator in establishing approved decanting sites for vacuum truck waste.
- In ASBS, there are priority outfall locations that shall be inspected once prior to the beginning of the rainy season and once during the rainy season and maintained to remove trash and other anthropogenic debris. Details of outfall locations can be found in the Maintenance stormwater website - <https://onramp.dot.ca.gov/hq/maint/OMSWEC/Stormwater.shtml>.

### Maintenance:

- District staff should observe culverts and drain inlets annually in the fall and throughout the winter as needed to determine if cleaning or repairs are required. Culverts will be cleaned when sediment adversely impacts culvert function.
- Remove all waste and debris when a drainage inlet, culvert, or catch basins has accumulated to a depth of 50% capacity. This does not preclude a Maintenance Supervisor's judgment to clean with less accumulated material present for highway safety and preservation.
- Ditches will be cleaned prior to the rainy season to maintain the hydraulic capacity of the ditch. Ditches and gutters will be sealed or repaired when structural integrity is endangered.
- Downdrains will be inspected annually and cleaned or repaired as necessary



## C.22.2 Enhanced Storm Drain Inlet Inspection and Cleaning Program

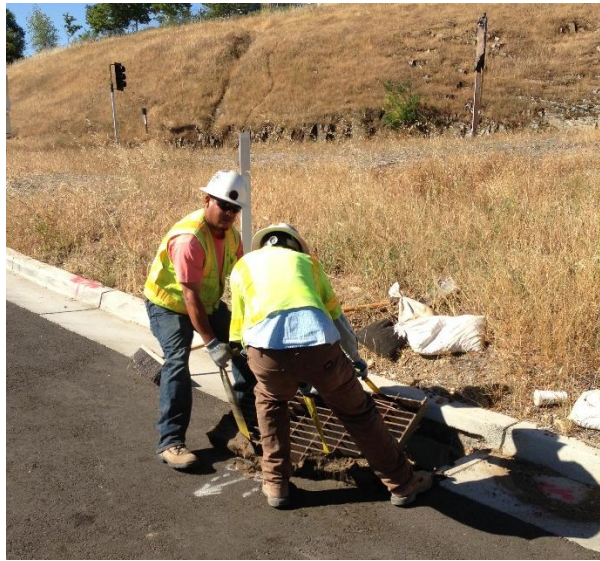

Figure C.22.2-1 Enhanced Storm Drain Inlet Inspection and Cleaning Program

### Description:

In the metropolitan portions of Los Angeles, San Diego, Orange and Ventura Counties, the storm drain inlets will be inspected and cleaned annually prior to the rainy season. Those storm drain inlets that contain 12 inches or more of accumulated material will be cleaned. Inspection and cleaning activities will be reported annually by section of highway.

### Appropriate Applications:

Within the target counties, an annual inspection and cleaning program should be implemented. This program will not address left shoulder, median or ramp inlets that require lane closures for access. Right shoulder inlets and other inlets that do not require lane closures should be inspected and the impact of litter and debris from these inlets should be assessed in the Monitoring and Research Program. Inspection and cleaning activities should be reported annually by county, route and post mile.

### Implementation:

- Inspect drain inlets annually in the target counties to determine if cleaning is required or if damage has occurred.
- Clean inlets of accumulated material in accordance with regulatory mandates.
- Maintain records and a database of inspection and cleaning information.

### C.22.3 Illegal Connection and Illicit Discharge (IC/ID)



Figure C.22.3-1 Illegal connection and Illicit Discharge

#### Description:

Section 92 of the Streets and Highways Code states that the Department may do any act necessary, convenient or proper for the maintenance of all highways which are under its jurisdiction, possession or control. Section 27 of the Streets and Highways Code defines “maintenance” and includes maintenance or repair necessitated by unusual or unexpected damage to a roadway, structure or facility.

This management practice is directed at eliminating illicit discharges and continuous or recurring discharges through illegal connections to stormwater drainage systems or as run-on from adjacent properties into Caltrans stormwater drainage systems.

Illegal connections are connections to Caltrans drainage systems that have not been approved by Caltrans. Illegal connections are encroachments as defined in Section 660 of the Streets and Highways Code. Illegal connections may carry unauthorized drainage, wastewater, or other illicit discharges to the Department's storm drain system from adjacent properties. These connections may carry pollutants into the storm drain system. Illegal connections may be intentional or may be unknown to the property owner.

An illicit discharge is a discharge onto Caltrans rights-of-way, Caltrans properties, facilities or from activities that is not composed entirely of stormwater and is not authorized pursuant to Section B of the Department's Caltrans NPDES Permit. Illicit discharges are considered “illicit” because Municipal Separate Storm Sewer Systems (MS4s) are not designed to accept, process, or discharge non-stormwater wastes.

The Department has authority over its property and investigates and resolves illegal connections and illicit discharges discovered within the right-of-way. Resolution may involve the elimination of the illegal connection and illicit discharge, proper permitting, or other appropriate actions including external enforcement and/or regulatory agencies involvement.

## Appropriate Applications:

The detection and reporting of illegal connections and illicit discharges (IC/IDs) apply to all field activities performed by maintenance staff. If illegal connections and/or illicit discharges are discovered, they are to be reported and actions taken in accordance with the best management practices defined here.

## Implementation:

### Detection

Where applicable, maintenance field personnel as part of their routine inspections and maintenance activities shall examine work areas for the existence of illegal connections and illicit discharges.

Maintenance District Stormwater Coordinators, Supervisors or Supervisor designated staff shall investigate potential incidences of illegal connections and illicit discharges reported by the public, by phone, to District Public Information Offices or which have been reported through the Maintenance Service Request (MSR) process on-line.

### Investigation

Maintenance personnel shall complete the Division of Maintenance standardized form MTCE07 (Rev. 12/2011) in conducting an IC/ID investigation at detected sites.

The investigation should document, where possible, the minimum following information.

The investigators name, title, reporting facility, cost center number and contact phone number

Date, Time of the investigation

Location address and the source of the discharge and/or illegal connection

Description of source property (business or homeowner)

Conversations with responsible party and or reporting party

Contact names, addresses and phone numbers

The type of substance discharged and the duration it has been discharging

Physical and chemical characteristics of the discharge (color, smell)

Plant and/or animal indicators present (plant discoloration, dead fish/rodents)

Where the discharge flows to (drainage ditch, culvert, water body etc...)

Photographic evidence

### Reporting

The MTCE07 form completed during the site investigation contains the initial reporting information.

Maintenance staff investigating sites should make copies of the MTCE07 form and forward a copy to the District Maintenance Stormwater Coordinator. If hazardous materials are known or suspected, the District Hazardous Materials Manager should be notified immediately and also forwarded a copy of the investigation report form. The form is available online at <http://cefs.dot.ca.gov/forms/index.html> and can be completed and distributed electronically.

Maintenance field staff responding to a public report of an IC/ID should document the response on the MTCE07 form and follow Maintenance the Service Request (MSR) policy.

The Maintenance Stormwater Coordinator shall coordinate with the District NPDES coordinator and provide a copy of the investigative report form.

The District NPDES Coordinator maintains the Department's database of illegal connections and illicit discharges information for regulatory tracking purposes.

Maintenance field staff shall properly enter IC/ID activities completed into the Integrated Maintenance Management System (IMMS) Database for Division of Maintenance tracking.

### Corrective Action

In the event that illegal connections and illicit discharges to the Department's storm sewer system are used to intentionally introduce chemical, biological, radiological or other life threatening agents into the environment (an act of terrorism), corrective actions shall be in accordance with the Department's Emergency Operations Plan.

When a highway spill (illicit discharge) causes an immediate threat to life, property or the environment and impacts the traveled way, such as a hazardous materials spill, actions taken shall be in accordance with Maintenance Policy Directive Number 0601 Emergency Highway Spill Clean-up and applicable sections of the Maintenance Manual Vol. 1, Chapter. Section D5. These are spills requiring a multi-agency response.

Actions taken to remove illicit discharges due to illegal encampments shall be in accordance with Maintenance Policy Directive Number 1001 Illegal Encampments.

In accordance with Section 721 of the Streets and Highways Code, the Department may immediately remove from any State highway any illicit discharge or illegal connection encroachment which:

obstructs or prevents the use of such highway by the public;

consists of refuse;

is a non-approved, non-permitted advertising sign of any description.

In accordance with Section 721 of the Streets and Highways Code, the Department may immediately remove from any State highway any encroachment, such as pipes or illegal connections, which is not removed, or the removal of which is not commenced and thereafter diligently prosecuted, prior to the expiration of five days from and after the service of a notice. The standard form TR0123 Notice of Encroachment (Red Tag) is to be used and is available on the forms website.

District Maintenance staff removal of illicit discharges consisting of illegal dumping including animal carcasses shall be in accordance with the Maintenance Manual Vol. 1, Chap. D1, Section D108. Animal carcasses shall not be relocated to or disposed of within 150 feet of waterways or drainage ways or buried within five feet of groundwater. Area superintendents shall provide disposal procedures subject to local rules and regulations.

District Division of Maintenance field staff may assist District Environmental staff and regulatory agencies, if requested to do so, in conducting IC/ID investigations of ongoing illegal connections and illicit discharges where the source is not immediately determined.

### Training

- Maintenance Supervisors should conduct a minimum of one IC/ID procedures review tailgate training meeting with their staff annually. A Division of Maintenance Stormwater Bulletin on Illegal Dumping and Spill Control is available to assist as a handout. A te e f t e te t tt te e. . t. . tt e t te - e-
- Formal refresher training is required for all field personnel at a minimum of once every four years and within the first year for new employees. This training includes a training module with more in-depth discussion and video aids on the Department's IC/ID policies and procedures.



### C.22.4 Illegal Spill Discharge Control



Figure C.22.4-1 Illegal Spill Discharge

#### Description:

This procedure calls for maintenance field staff who detect illegal dumping, discharges and spills of pollutants on Caltrans properties and facilities to report them.

This BMP is directed at incidents involving dumping, discharges or spills that affect stormwater.

#### Appropriate Applications:

Any spills or dumped materials that are observed by maintenance personnel shall be reported.

#### Implementation:

Any illegal dumping or spilling of materials observed by field personnel, as part of their routine inspections and maintenance work, shall be reported to the District Stormwater Coordinator by their Maintenance Supervisor. The District Maintenance Storm Water Coordinator will forward these observations to the District NPDES Coordinator. A MTCE07 form is completed during the site investigation for the initial reporting information.

The Maintenance Supervisor will verbally notify the District NPDES Coordinator within 5 working days of a reportable non-compliance issue (see SWMP Section 16.2 for list of reportable non-compliance issues). The District NPDES Coordinator will complete the regulatory notifications (Incident Report form) of reportable non-compliance issue.

If a Maintenance Supervisor suspects that the dumping of hazardous materials or hazardous waste has occurred, the supervisor shall report the incident to the District Hazardous Materials Manager.

Spill cleanup shall be handled in accordance with the legal authority presented in Section 2.6 of the SWMP

## C.23 Structural Treatment System Maintenance

The following systems represent the approved TBMPs that have been approved as technically and fiscally feasible in reducing constituents of concern to improve water quality. The systems include:

- C.23.1 Biofiltration Strips and Swales,
- C.23.2 Infiltration Basins,
- C.23.3 Infiltration Trenches,
- C.23.4 Detention Devices,
- C.23.5 Traction Sand Traps,
- C.23.6 Gross Solids Removal Devices,
- C.23.7 Austin Sand Filters,
- C.23.8 Delaware Sand Filters,
- C.23.9 Multi-Chambered Treatment Trains,
- C.23.10 Wet Basins,
- C.23.11 Design Pollution Prevention Infiltration Areas,
- C.23.12 Bioretention, and
- C.23.13 Open Graded Friction Course

This section of the Staff Guide describes typical TBMPs and their recommended maintenance. Actual field TBMPs may vary from the standard schematics shown in this section. Division of Maintenance supervisory staff may modify the recommended frequency of a maintenance activity on a site-specific basis to ensure functionality but no less than one inspection, cleaning or repair annually.

Previous study of TBMPs demonstrated that inspection frequency and vegetation management were primary cost factors (BMP Retrofit Pilot Study Final Report, CTSW-RT-01-050). Consequently, these items are minimized in this document, though other district policies, such as fire safety and aesthetics, may dictate more frequent maintenance. Further, with increasing numbers of TBMPs, it is critical that the work schedule is prioritized and adequate staff, materials and equipment are available (Table C.23-1) (i.e. unclog a BMP that needs immediate maintenance). If the BMP is inspected 3 days after a storm event, concurrent unclogging may allow draining before the 96-hour limit for vector breeding and vector control district consultation (SWMP Section 4.5.1 [2016]). It also allows subsequent maintenance, if needed, to be scheduled during a dry period rather than the period immediately following a storm, which is often a period of peak demand on maintenance resources.

There may be occasions where emergencies arise, such as accidents, toxic spills, or other incidents, where immediate response is needed. On those occurrences, Caltrans crews will respond to the emergency, on a priority basis and, if necessary, the BMP will be taken out of service until the BMP functionality can be restored. The goal for such critical situations is to have the BMP back into service within 30 days.

Prior to intrusive maintenance at any BMP, maintenance personnel should check with the District biologist to ensure there are no endangered species, threatened species or species of special concern within the BMP maintenance area.

This section does not include maintenance that may be necessary for vector control of devices that hold a permanent pool of water where vector prevention has failed. In such cases the local vector control authority should be consulted.

For many TBMPs, the wet season inspections are scheduled 3 days after substantial rainfall events (0.75 inches is suggested for most areas of California), which requires tracking storm size and when the

storm event ended. A rain gauge at the maintenance station can be used to verify storm size. Caltrans maintenance personnel may also use Internet weather resources like the National Oceanic and Atmospheric Administration's (NOAA's) National Weather Service (<http://www.nws.noaa.gov/>). Begin a search by typing in the local city and state in the search box in the upper left corner of the web page.

**Table C.23-1 Inspection and Equipment List**

Item	Purpose
Hard hat, boots, gloves, reflective safety vest, eye protection, hearing protection	Safety and comfort
Camera, inspection forms, tape measure	Documentation
Plumbing snake and thin rod	Unclogging orifices
Metal rake, shovel	Breaking up accumulated sediment that act as dams, scarifying infiltration basins and filters,



### C.23.1 Biofiltration Strips and Swales



Figure C.23.1-1 Biofiltration Swale

#### Description:

These measures are intended to maintain established biofiltration swales and strips as effective devices for treating runoff discharges. These requirements for inspection and maintenance will allow the devices to continue to function as designed for water quality purposes.

#### Appropriate Application:

The BMP maintenance described in Table C.23.1-1 and Table C.23.1-2 apply to personnel that inspect and maintain biofilter swales, where water depths tend to be deeper than strips so plant height guidelines may be helpful to performance. For strips, the Roadside Vegetated Treatment Sites (RVTS) Study (CTSW-RT-07-127.01.2) characterized the treatment benefit of roadside strips that did not have a water quality based maintenance program. The comparison of the RVTS results with previous studies suggest that maintenance of biofiltration strips, beyond the Department's current statewide protocols for vegetation, do not enhance pollutant removal. Therefore, biofiltration strips and other RVTS-type areas that receive sheet flow should be maintained according to existing district maintenance protocols. Further, some areas may have strips that do not have vegetation to design standards (e.g. approximate 65 percent coverage) because soil and climate may limit the success of establishment. In these cases, stormwater treatment benefit may still occur, mostly from infiltration, so a continual effort to force establishment of vegetation may not be justified. Refer to the District landscape architect office for advice on identifying these circumstances.

Swales tend to have higher water depths than strips, so preventive and corrective maintenance for maintaining plant vegetation height should be implemented.

The preventive maintenance routine is described in Table 23.1-1, and the corrective maintenance activities are described in Table C.23.1-2.

Mowing or cutting vegetation in TBMP areas will not improve treatment performance, however, vegetation control in TBMPs is necessary for fire prevention, safety, reduction of noxious/invasive weeds and even for esthetic reasons.

Chemical vegetative control measures will not be used on vegetated TBMPs except where Caltrans is directed by the California Department of Food and Agriculture to treat the BMPs for invasive weeds. Fire control strips up to 8 feet wide may be maintained through chemical applications adjacent to biofiltration strips and swales. The areas used for fire control will not be considered as part of the treatment system. Report the use of chemicals in the Caltrans Stormwater Management Annual Report.

### Implementation:

Field measurements of maintenance indicators are made by visual observation. Frequencies provided are for the minimum required level of service. Greater maintenance frequencies may be required depending on the particular site and level of traffic. A schematic of a biofiltration swale and strip is shown in Figure C-23.1-2.

Table C.23.1-1 Biofiltration Swales Systems Preventative Maintenance		
Frequency	Routine Action	Activity Cut-Sheet Page
Annually	Mow grass, grass-lined swales and strips to a minimum height of 6 inches.	B-56, B-58

Table C.23. 1-2 Biofiltration Swales Systems Maintenance Activities		
Maintenance Indicator	Inspection Frequency	Maintenance Activity
Evidence of significant channeling, erosion, seeps, or ponding	Annually in late wet season	Correct channelized, eroded, seeped, or ponded areas using additional fill and vegetation depending on coverage and/or by removing accumulated sediment. Complete prior to next wet season.
Average vegetation height exceeds 12 inches, emergence of trees, or woody vegetation	Semi-Annually, once during wet season, once during dry season (depending on growth)	Cut vegetation to a minimum height of 6 inches; cuttings may be removed at discretion of District Maintenance.
Less than 70 percent background coverage in swale invert and swale side slope	Semi-Annually, once late wet season and once late dry season	Assess quantity needed and reseed/revegetate barren spots by November. Contact environmental or landscape architect for appropriate seed mix. Scarify area to be restored, to a depth of 2- inches. Restore side slope coverage with hydroseed mixture. If growth is unsuccessful after 2 applications (2 seasons) of reseeding/revegetating, consult with District Landscape Architect for potential solutions. Maintain shrubs and trees that were installed in the original design
Debris/trash present	Inspect during routine trash collection. Minimum twice per year during inspections.	Remove litter, and debris per routine District schedule.
Sediment at or near vegetation height, channeling of flow within swale and energy dissipaters, inhibited flow due to change in slope	Annually in the dry season	<ul style="list-style-type: none"> <li>Remove sediment. If flow is channeled, determine cause and take corrective action. If sediment becomes deep enough to change the flow gradient, remove sediment during dry season, characterize and properly dispose of sediment, and revegetate. Refer to Activity Cut-Sheet Page B-72.</li> <li>Notify engineer or District Maintenance Storm Water Coordinator to determine if regrading is necessary.</li> <li>If regrading is necessary, regrade to design specification and revegetate swale/strip. Regrading should start in May. Revegetate strip/swale by spring or fall. Target completion prior to wet season.</li> </ul>
Burrows, holes, mounds	Annually and after vegetation trimming	Where burrows cause erosion or jeopardize structural integrity, backfill firmly.
Water accumulation in spreader ditch and/or collector ditch for more than 72 hours	Within 72 hours after a storm event 0.75 inches or greater. If no such event occurs before April 1, conduct wet season inspections in April.	<ul style="list-style-type: none"> <li>At the time of inspection, de-water the spreader ditch to a depth of less than</li> <li>0.25 inches. If sediment impedes the de-watering activity, then move or remove that portion of the sediment.</li> <li>Characterize if necessary and properly dispose.</li> </ul>
Inlet structures, outlet structures, side slopes or other features hindered by debris or damaged, significant erosion, fence damage, graffiti, vandalism, etc.	Semi-annually, late wet season and late dry season	<ul style="list-style-type: none"> <li>Repair/take corrective action prior to wet season.</li> <li>Contact the District Maintenance Stormwater Coordinator if repairs /solutions are not readily available in the field. The District Maintenance Storm Water Coordinator will coordinate with appropriate staff for repairs/solutions.</li> </ul>

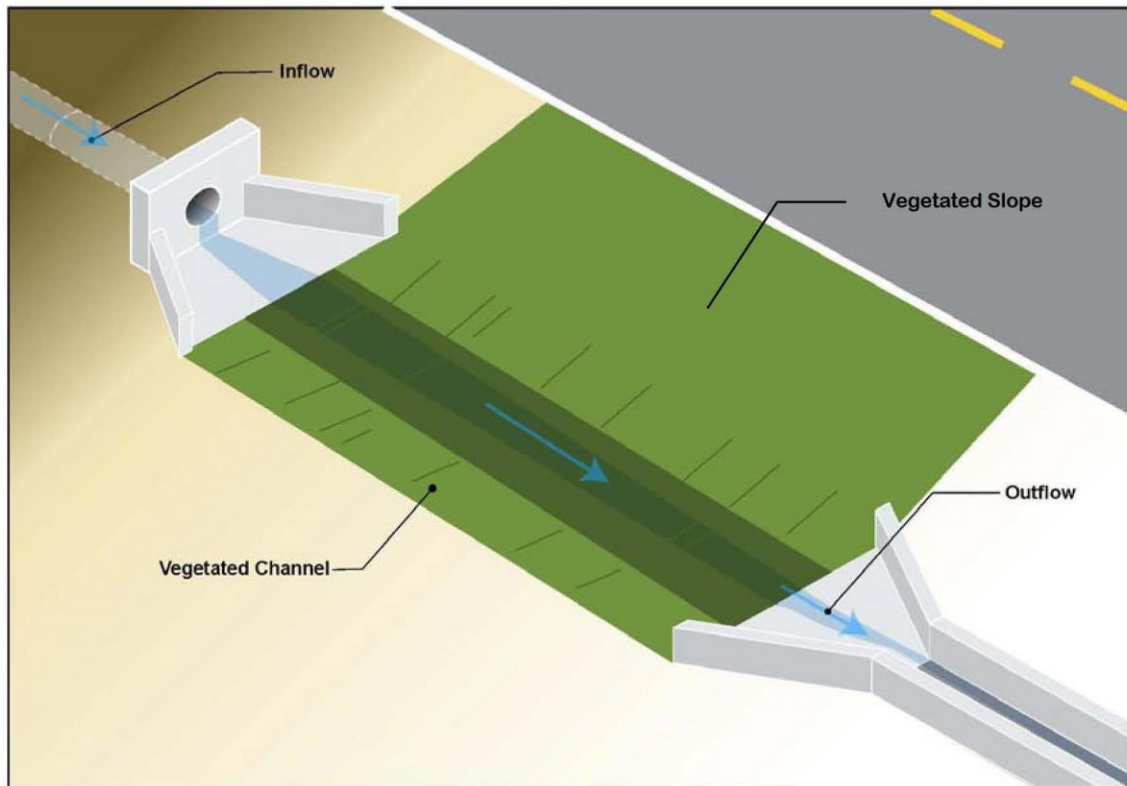

Figure C-.23.1-2 Schematic of a Biofiltration Swale & Strip

## C.23.2 Infiltration Basins



Figure C.23.2-1 Infiltration Basin

### Description:

These measures are intended to maintain infiltration basins as effective devices for treating runoff discharges. These requirements for inspection and maintenance will allow the devices to continue to function as designed for water quality purposes.

### Appropriate Applications:

The BMP preventive maintenance routine described in Table C.23.2-1, and the actual maintenance activities described in Table C.23.2-2 apply to personnel who inspect and maintain infiltration basins. A schematic of an infiltration basin is shown in Figure C.23.2-1.

### Implementation:

Field measurements of maintenance indicators are made by visual observation. The illustration below provides a graphical representation of the drain time threshold for standing water:

Table C.23.2-1. Infiltration Basin Preventative Maintenance		
Frequency	Routine Action	Activity Cut-Sheet Page
Annually at the end of the wet season	Trim vegetation to a minimum height of 6 inches.	B-56, B-58

Table C.23.2-2. Infiltration Basin Maintenance Activities		
Maintenance Indicator	Inspection Frequency	Maintenance Activity
Emergence of trees or woody vegetation	Once during wet season, once during dry season	Remove any trees, or woody vegetation at District Maintenance discretion, reasons may include maintenance access, clogged inlets, or tree preservation requirements in coastal zone.

Table C.23.2-2. Infiltration Basin Maintenance Activities

Debris/trash present	Inspect during routine trash collection, minimum twice per year	Remove and dispose of trash and debris per routine District schedule.
Standing water for more than 72 hours	Annually within 72 hours after a 0.75-inch storm event. If no such event occurs before April 1, conduct wet season inspections in April.	<ul style="list-style-type: none"> <li>• Drain facility, if possible, by scarifying the invert or by opening the maintenance drain at the time of inspection.</li> <li>• Notify engineer or District Maintenance Storm Water Coordinator to consider the following: <ul style="list-style-type: none"> <li>• Remove sediment, scarify invert, and regrade if necessary.</li> <li>• If unable to achieve acceptable infiltration rate or implement alternative solution then move to decommission.</li> <li>• Remove, characterize, and properly dispose of sediment. Refer to Activity Cut-Sheet Page B-72.</li> </ul> </li> </ul>
Standing water for more than 96 hours	1 day after above inspection where standing water was observed and action taken.	Notify the District Maintenance Stormwater Coordinator/Vector Control District.
Sediment depth exceeds marker on staff gage	Annually in the dry season	<ul style="list-style-type: none"> <li>• Remove, characterize and properly dispose of sediment.</li> <li>• Regrade and revegetate bare areas. Guidelines on revegetation will be consistent with existing vegetation within basin.</li> <li>• Refer to maintenance activity for Evidence of Erosion' indicator for guidelines on revegetation.</li> </ul>
Evidence of erosion	During dry season	<ul style="list-style-type: none"> <li>• Reseed/revegetate barren spots prior to wet season.</li> <li>• Contact environmental or landscape architect for appropriate seed mix.</li> <li>• Scarify surface if needed. If after two applications (2 seasons) of reseeding/revegetating and growth is unsuccessful both times, an erosion blanket or equivalent protection will be installed over eroding areas. No erosion blanket will be installed in the basin invert.</li> </ul>
Burrows, holes, mounds	Annually and after vegetation trimming	Backfill firmly where burrows cause erosion or jeopardize structural integrity.
Inlet structures, outlet structures, side slopes or other features hindered by debris or damaged, significant erosion, graffiti or vandalism, fence damage, etc.	Semi-Annually, late wet season and late dry season	Take corrective action prior to wet season. If repair solutions are not readily available in the field notify the District Maintenance Stormwater Coordinator who will coordinate with appropriate staff.
Average plant height is greater than 12 inches	Inspect once during wet season and once during dry season	Cut or remove vegetation and clippings as appropriate.

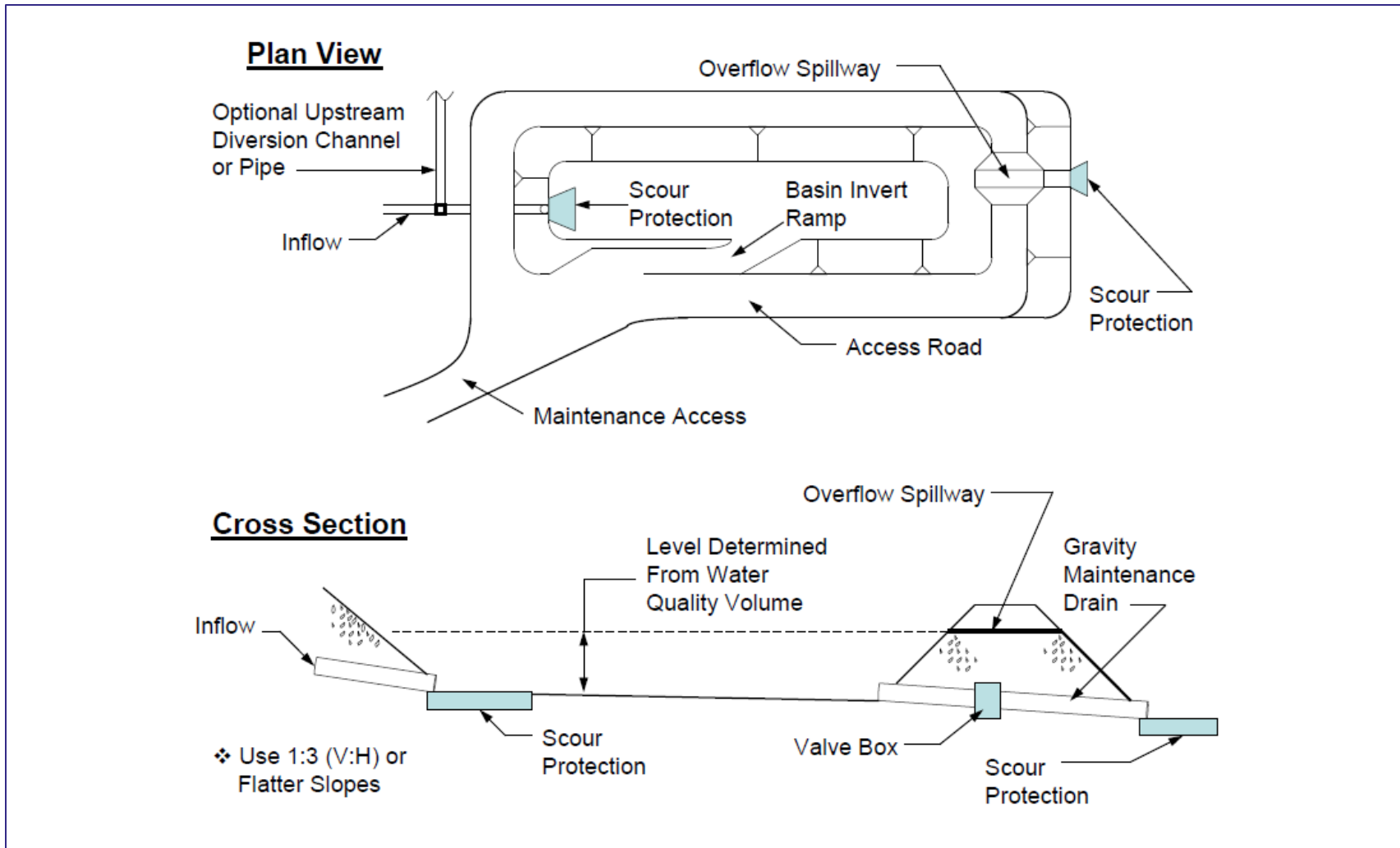

Figure C.23.2-21. Schematic of an Infiltration Basin



### C.23.3 Infiltration Trenches



Figure C.23.3-1 Infiltration Trench

#### Description:

These measures are intended to maintain effective infiltration trenches for treating runoff discharges. These requirements for inspection and maintenance will allow the devices to continue to function as designed for water quality purposes.

#### Appropriate Application:

The BMP maintenance activities described in Table C.23.3-1 apply to personnel who inspect and maintain infiltration trenches. A schematic of an infiltration trench is shown in Figure C-23.3-1.

#### Implementation:

Field measurements of maintenance indicators are made by visual observation. The illustration below provides a graphical representation of the drain time threshold for standing water:

Table C.23.3-1 Infiltration Trench Maintenance Activities

Maintenance Indicator	Inspection Frequency	Maintenance Activity
Standing surface water for more than 72 hours	Annually within 72 hours after a 0.75 inch storm event. If no such event occurs before April 1, conduct wet season inspections in April.	<ul style="list-style-type: none"> <li>Notify engineer or District Maintenance Storm Water Coordinator to consider the following:               <ul style="list-style-type: none"> <li>Undertake investigation for course of action to achieve acceptable infiltration rate. If unable to achieve acceptable infiltration then BMP operations cease.</li> </ul> </li> <li>Remove top 18-inch layer of trench, including surface gravel layer, filter fabric, and trench filler material; wash trench filler material and reinstall surface gravel layer, filter fabric, and trench filler material into trench prior to wet season. Refer to Activity Cut-Sheet Page B-72.</li> </ul>
Standing water for more than 96 hours	1 day after above inspection where standing water was observed and action taken.	Notify the District Maintenance Storm Water Coordinator/Vector Control District.
Trash/debris	Inspect during routine trash collection- Minimum twice per year	Remove and dispose of trash and debris per routine
Visible sediment	Annually in the dry season	<ul style="list-style-type: none"> <li>Remove top 18-inch layer of trench, including surface gravel layer, filter fabric, and trench filler material;</li> <li>Wash trench filler material and reinstall surface gravel layer, filter fabric, and trench filler material into trench prior to wet season. When washing trench filler material do not allow untreated rinse water to enter storm drain.</li> <li>Install prior to wet season.</li> </ul>
Inlet structures, outlet structures, filter fabric or other features hindered by debris or damaged, emergence of trees or woody vegetation, graffiti or vandalism, fence damage, etc.	Semi-Annually, late wet season and late dry season	<ul style="list-style-type: none"> <li>Take corrective action, prior to wet season.</li> <li>If repair solutions are not readily available in the field notify the District Maintenance Storm Water Coordinator who will coordinate with appropriate staff.</li> </ul>

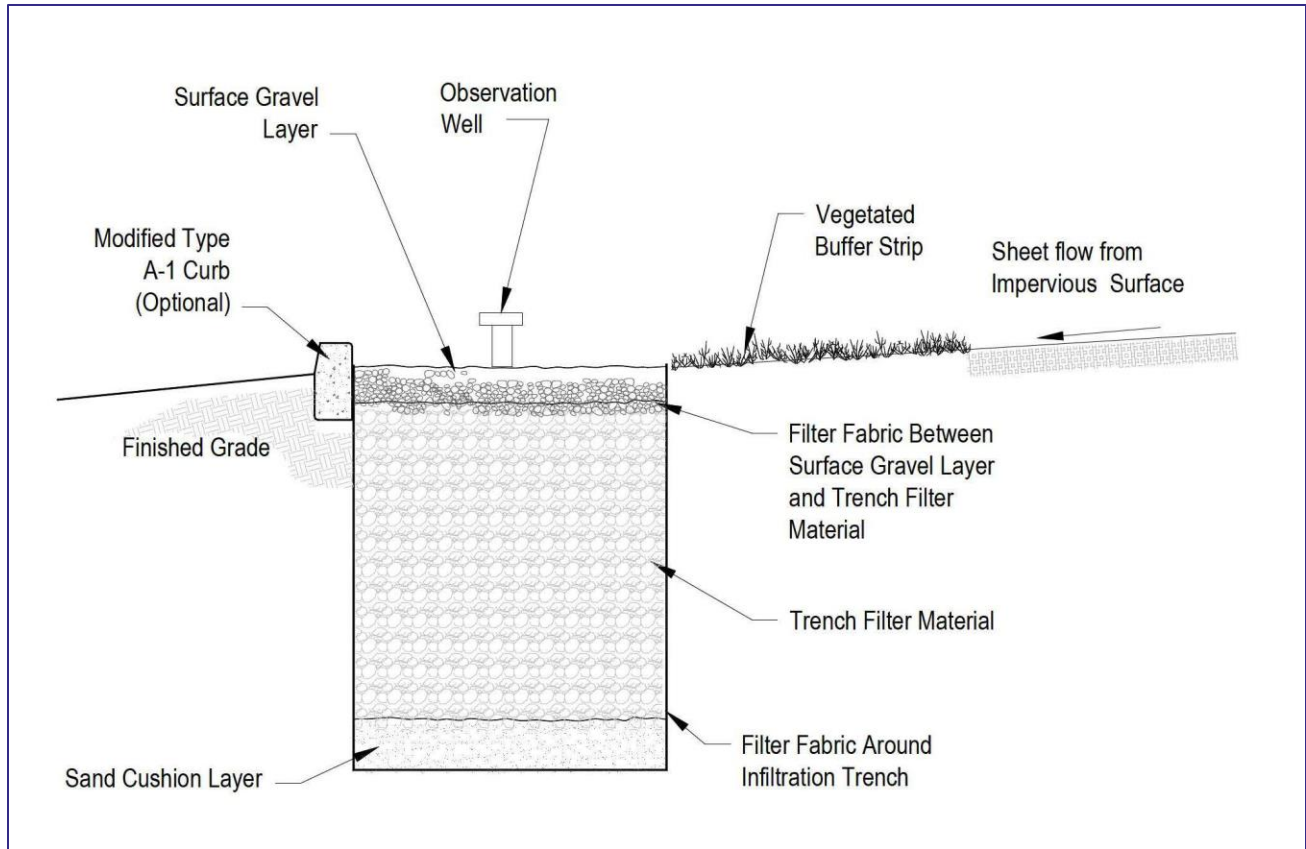

Figure C.23.3-2. Schematic of an Infiltration Trench

### C.23.4 Detention Devices



Figure C.23.4-1 Detention Basin

#### Description:

These measures are intended to maintain effective detention devices for treating runoff discharges. These requirements for inspection and maintenance will allow the devices to continue to function as designed for water quality purposes.

#### Appropriate Application:

The BMP preventive maintenance routine described in Table C.23.4-1, and the actual maintenance activities described in Table C. 23.4-2 apply to personnel who inspect and maintain detention devices. A schematic of a detention device is shown in Figure C. 23.4-1. A schematic of a water quality outlet structure is shown in Figure C. 23.4-2.

#### Implementation:

Field measurements of maintenance indicators are made by visual observation. The figure below provides a graphical representation of the drain time threshold for standing water:

Table C. 23.4-1 Detention Device Preventative Maintenance		
Frequency	Routine Action	Activity Cut-Sheet Page
Annually at the end of wet season	Remove accumulated debris around outlet structure	B-56, B-58, B-72

Table C. 23.4-2. Detention Device Maintenance Activities		
Maintenance Indicator	Inspection Frequency	Maintenance Activity
Emergence of trees or woody vegetation	Once during wet season, once during dry season	<ul style="list-style-type: none"> <li>Remove any trees, or woody vegetation if interferes with function of detention basins (impaired access to inlet/outlets, clogged outlets, or reduced storage volume).</li> </ul>
Trash/debris present	Inspect during routine trash collection	Remove and dispose of trash and debris per routine District schedule.

**Table C. 23.4-2. Detention Device Maintenance Activities**

Evidence of erosion	During dry season	
Standing water for more than 72 hours	Within 72 hours after a storm event 0.75 inches or greater. If no such event occurs before April 1, conduct wet season inspections in April.	<ul style="list-style-type: none"> <li>• Reseed/ revegetate barren spots prior to wet season.</li> <li>• Contact environmental or landscape architect for appropriate seed mix.</li> <li>• Scarify surface if needed.</li> <li>• If after two applications (2 seasons) of reseeding / revegetating and growth is unsuccessful both times, an erosion blanket or equivalent protection will be installed over eroding areas. No erosion blanket will be installed in the basin invert.</li> </ul>
Standing water for more than 96 hours	1 day after above inspection where standing water was observed and action taken.	<ul style="list-style-type: none"> <li>• Check and unclog clogged orifice at time of inspection.</li> <li>• Notify the District Maintenance Storm Water Coordinator if an immediate solution is not evident.</li> <li>• Remove, characterize, and properly dispose of sediment. Refer to Activity Cut-Sheet Page B-72.</li> </ul>
Sediment depth exceeds marker on staff gage (average 18 inches)	Annually in the dry season	Remove and properly dispose of sediment. Regrade if necessary. Characterize if needed.
Burrows, holes, mounds	Annually and after vegetation trimming	Where burrows cause erosion or jeopardize structural integrity, backfill firmly.
Inlet structures, outlet structures, side slopes or other features hindered by debris or damaged, significant erosion, graffiti or vandalism, fence damage, etc.	Semi-Annually, late wet season and late dry season	Take corrective action prior to wet season. Consult engineer or District Maintenance Storm Water Coordinator if immediate solution is not evident.
Average plant height is greater than 12 inches	Inspect once during wet season and once during dry season	<ul style="list-style-type: none"> <li>• Cut or remove vegetation and clippings as appropriate.</li> <li>• Cut vegetation with a mower blade set to a minimum height of 6 inches and remove trimmings.</li> </ul>

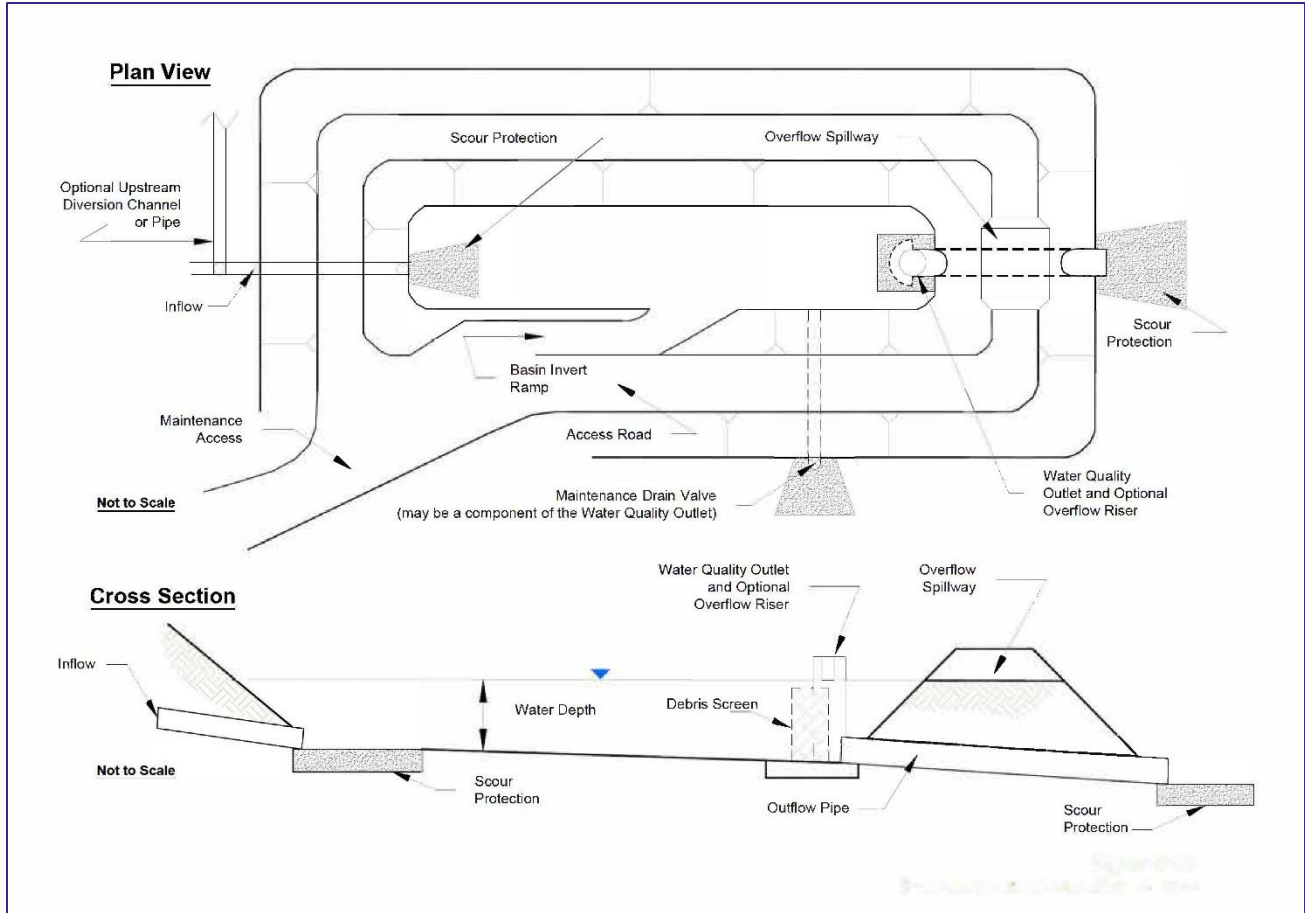

Figure C. 23.4-2. Schematic of a Detention Device

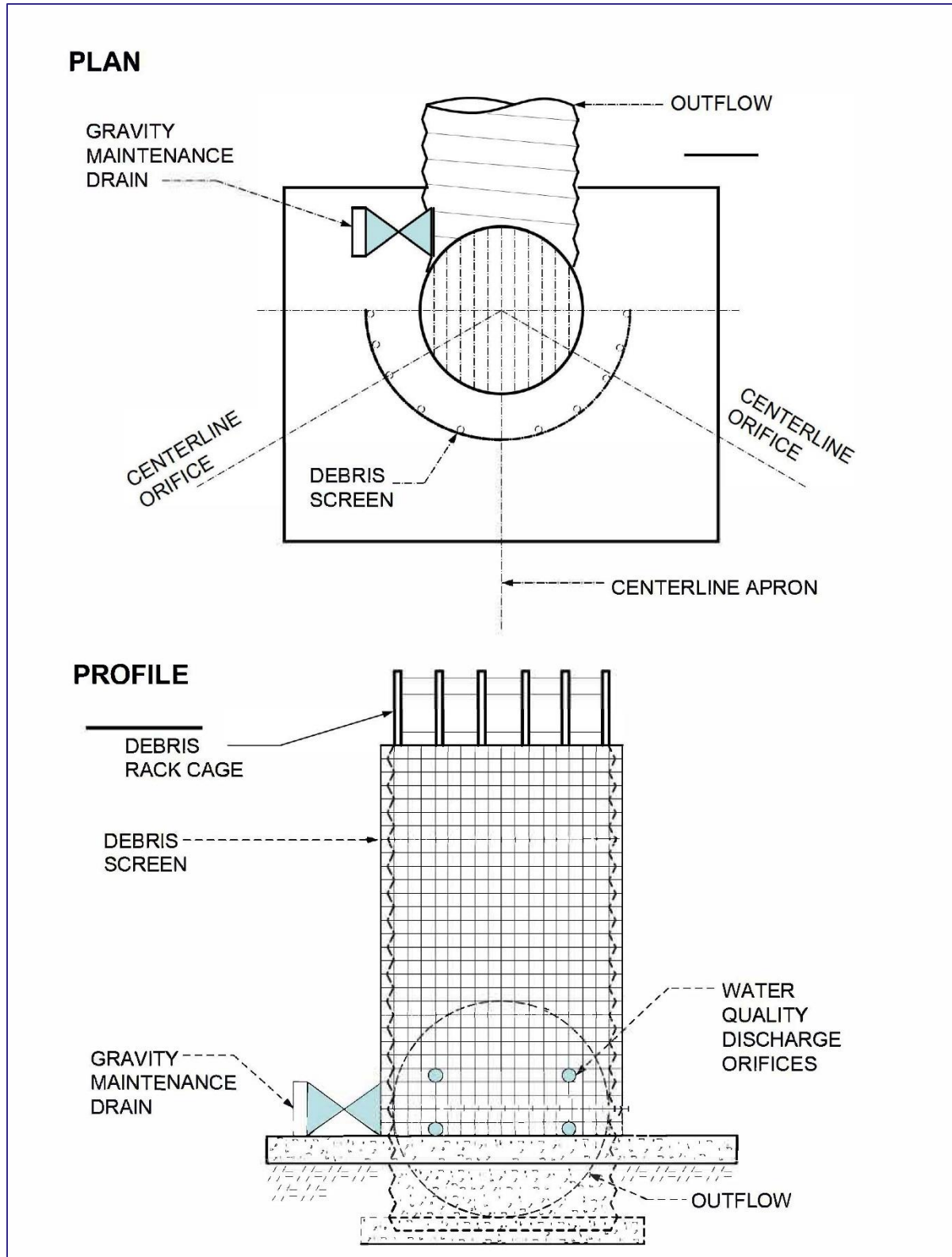

Figure C. 23.4-3. Schematic of a Water Quality Outlet Structure



### C.23.5 Traction Sand Trap Devices



Figure C.23.5-1 Traction Sand Trap Device

#### Description:

This BMP is intended to maintain sand trap devices as effective devices for treating runoff discharges. These requirements for regular inspection and maintenance will allow the devices to continue to function as designed.

#### Appropriate Applications:

The BMP maintenance described in Table C.23.5-1 applies to personnel who inspect and maintain traction sand trap devices. The maintenance activities are described in Table C.23.5-2.

#### Implementation:

Field measurements of maintenance indicators are made by visual observation. The illustration below provides a graphical representation of the drain time threshold for standing water. Schematics of a Traction Sand Trap are shown in Figures C.23.5-2 and C.23.5-3.

Table C.23.5-1 Traction Sand Trap Device Maintenance Activities		
Maintenance Indicator	Inspection Frequency	Maintenance Activity
Sediment volume exceeds design capacity	Inspect annually and after significant storms	Remove, characterize, and properly dispose of sediment. Refer to Activity Cut-Sheet Page B-72.
Inlet/outlet structural integrity, damaged structures, graffiti or vandalism, etc.	Semi-annually, late wet season and late dry season	<ul style="list-style-type: none"> <li>Take corrective action prior to wet season.</li> <li>Report general maintenance problems to the District Maintenance Storm Water Coordinator if immediate solution is not evident.</li> </ul>
Standing water in structure 72 hours after any storm.	Inspect 72 hours after one run-off generating storm per year.	Drain facility if possible. If standing water cannot be removed notify the District Maintenance Storm Water Coordinator/Vector Control District.

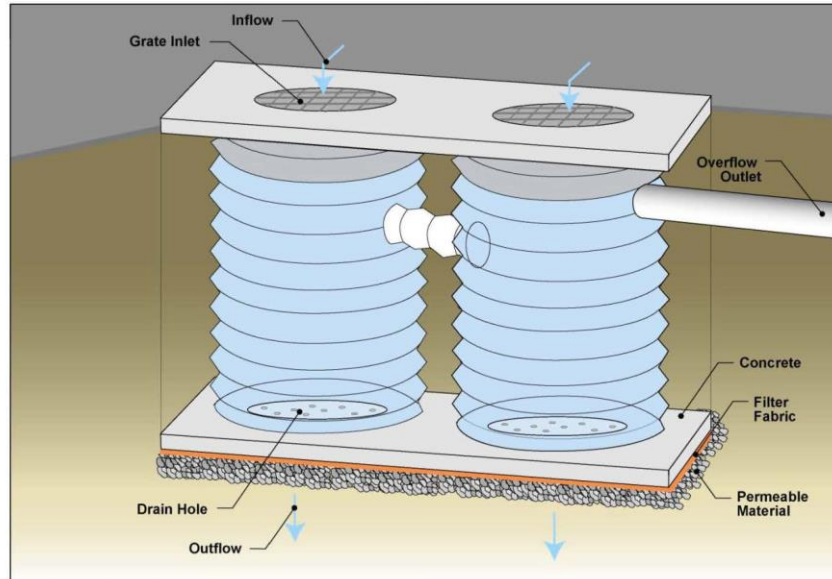

Figure C-23.5-2 Schematic of a Traction Sand Trap (Pipe Inlet Type)

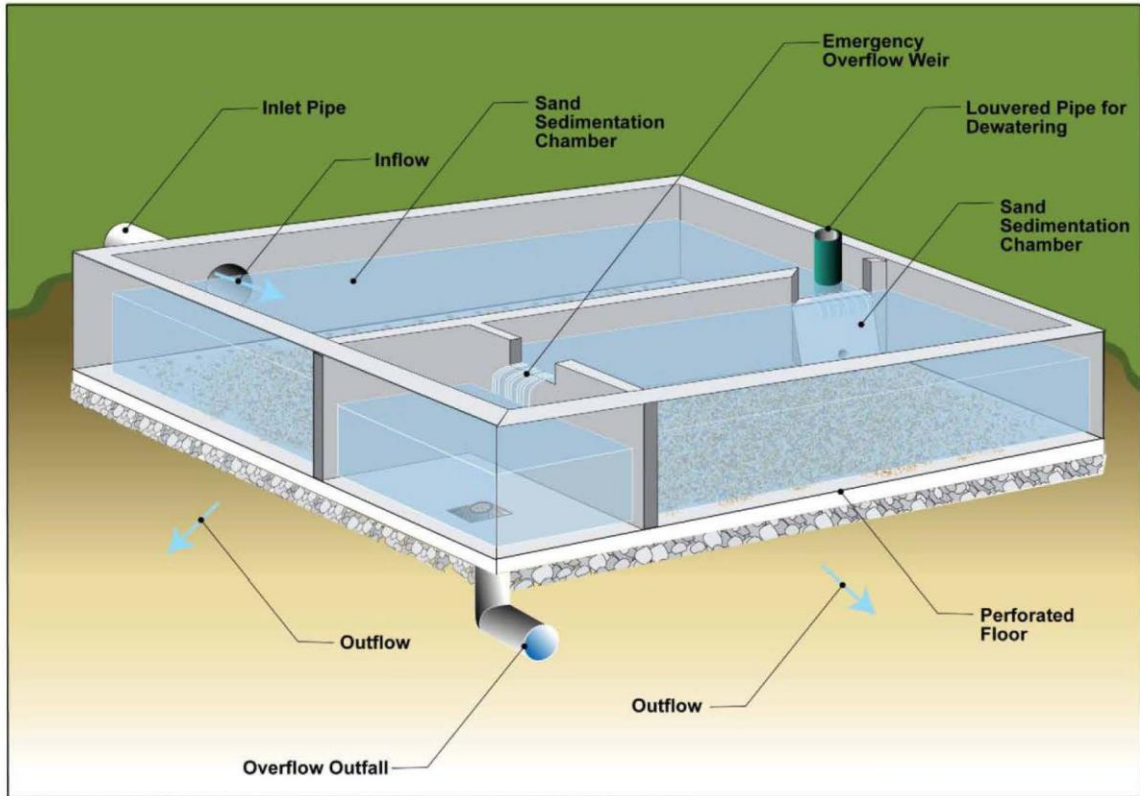

Figure C.23.5-3. Schematic of a Traction Sand Trap (Vault Type)

### C.23.6 Gross Solids Removal Devices



Figure C.23.6-1 Gross Solid Removal Device

#### Description:

This BMP is intended to maintain gross solids removal devices as effective devices for treating runoff discharges. These requirements for regular inspection and maintenance will allow the devices to continue to function as designed.

#### Appropriate Applications:

The BMP maintenance activities described in Table C.23.6-1 applies to personnel who inspect and maintain gross solids removal devices. Schematics of a Linear Radial Device are shown in Figures C. 23.6-2 and C-23.63. A schematic of a Type 1 Inclined Screen Device is shown in Figure C. 23.6-4, and a schematic of a Type 2 Inclined Screen Device is shown in Figure C. 23.6-5.

#### Implementation:

Field measurements of maintenance indicators are made by visual observation. The illustration below provides a graphical representation of the drain time threshold for standing water:

Table C.23.6-1. Gross Solids Removal Device Maintenance Activities

Maintenance Indicator	Inspection Frequency	Maintenance Activity
Inlet structures, outlet structures, or other features hindered by debris or damaged. Check for graffiti or vandalism.	Semi-annual Inspection, late dry season and end of wet season	<ul style="list-style-type: none"> <li>Take corrective action prior to wet season.</li> <li>Report to District Maintenance Storm Water Coordinator if immediate solution is not evident.</li> </ul>
Presence of gross solids (trash and debris)	Recommend monthly during the wetter months.	<ul style="list-style-type: none"> <li>Remove trash and debris as needed to maintain proper functioning. Minimum is to inspect for trash and debris with Semi-Annual Inspection.</li> <li>Remove accumulated gross solids. Refer to Activity Cut-Sheet Page B-72.</li> </ul>

**Table C.23.6-1. Gross Solids Removal Device Maintenance Activities**

Standing water in structure 72 hours after any storm	With Semi-Annual Inspection and 72 hours after any storm.	Remove standing water and material that may be impeding complete gravity drainage.
Standing water for more than 96 hours <sup>1</sup>	1 day after above inspection where standing water was observed and action taken.	Notify the District Maintenance Storm Water Coordinator/Vector Control District.
Screens <ul style="list-style-type: none"> <li>• clogged,</li> <li>• damaged</li> <li>• loose</li> </ul> do not open/ or close properly.	Minimum semi-annually, late dry season and end of wet season	<ul style="list-style-type: none"> <li>• Clean screens.</li> </ul> Contact the District Maintenance Storm Water Coordinator if repairs /solutions are not readily available in the field. The District Maintenance Storm Water Coordinator will coordinate with appropriate staff for repairs/solutions.

<sup>1</sup> Monitoring and abatement of vectors may be done through agreement with the local vector control authority.

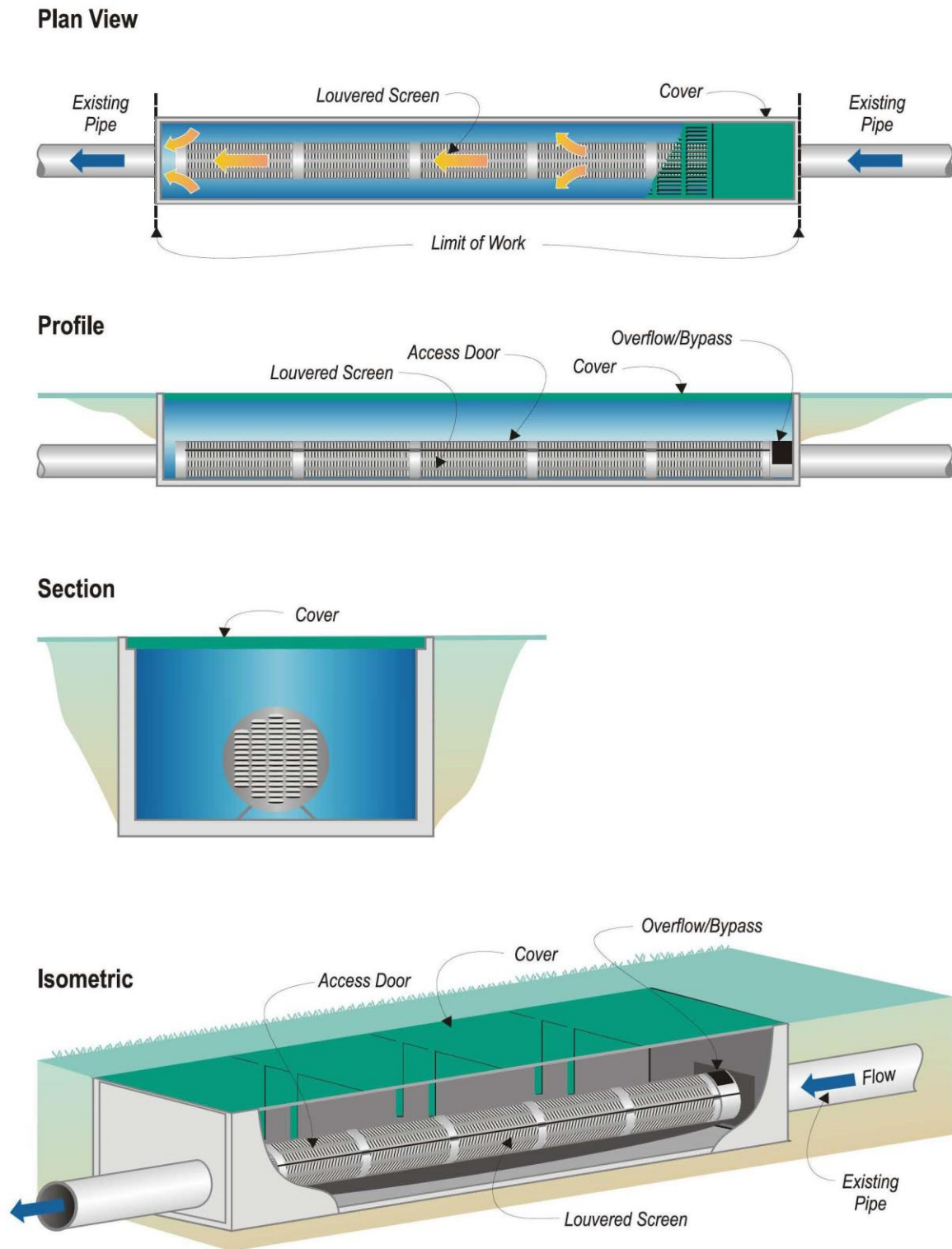

Figure C.23.6-2. Schematic of a Linear Radial Device



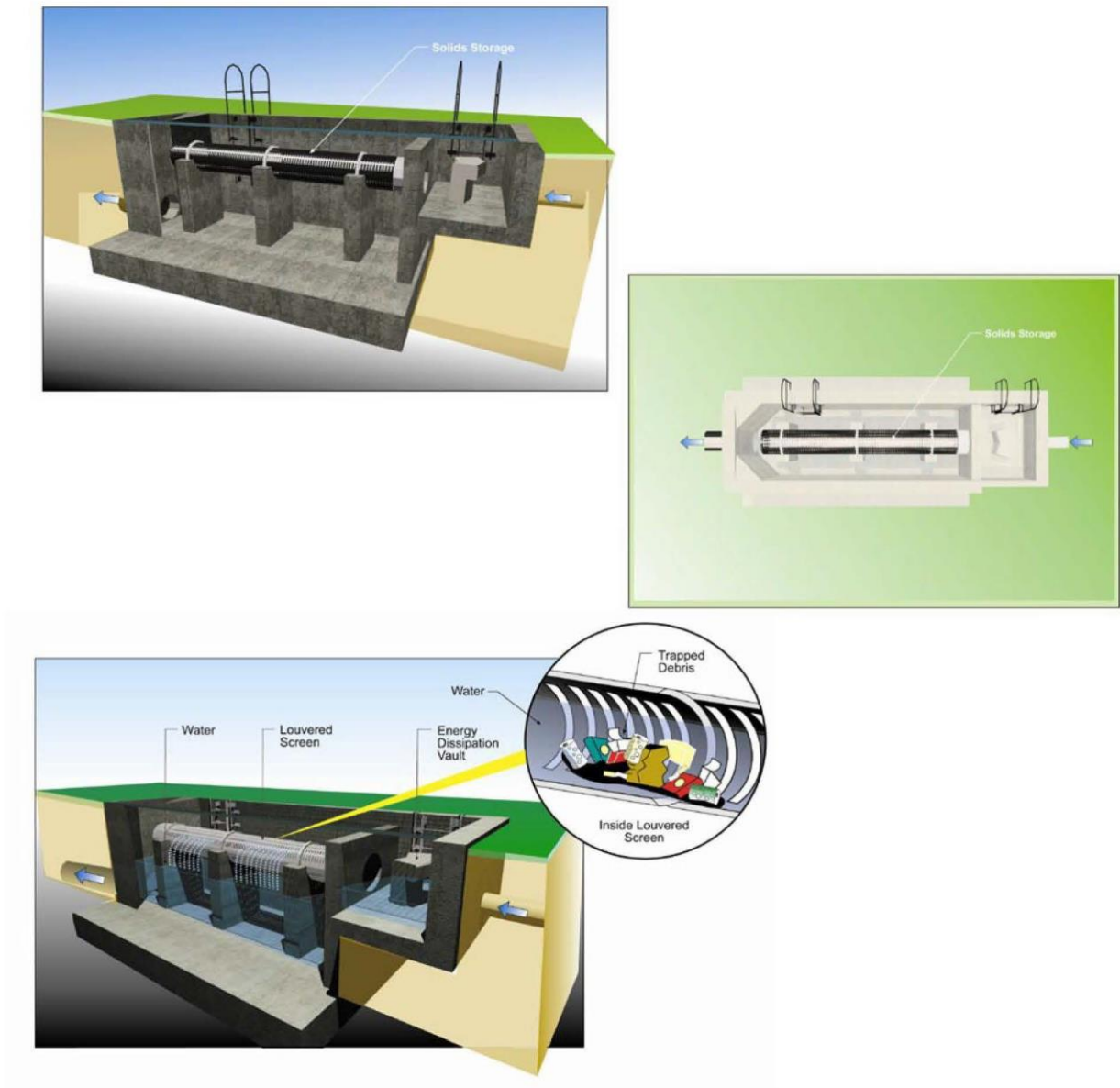

Figure C.23.6-3. Schematic of a Linear Radial Device (HV)



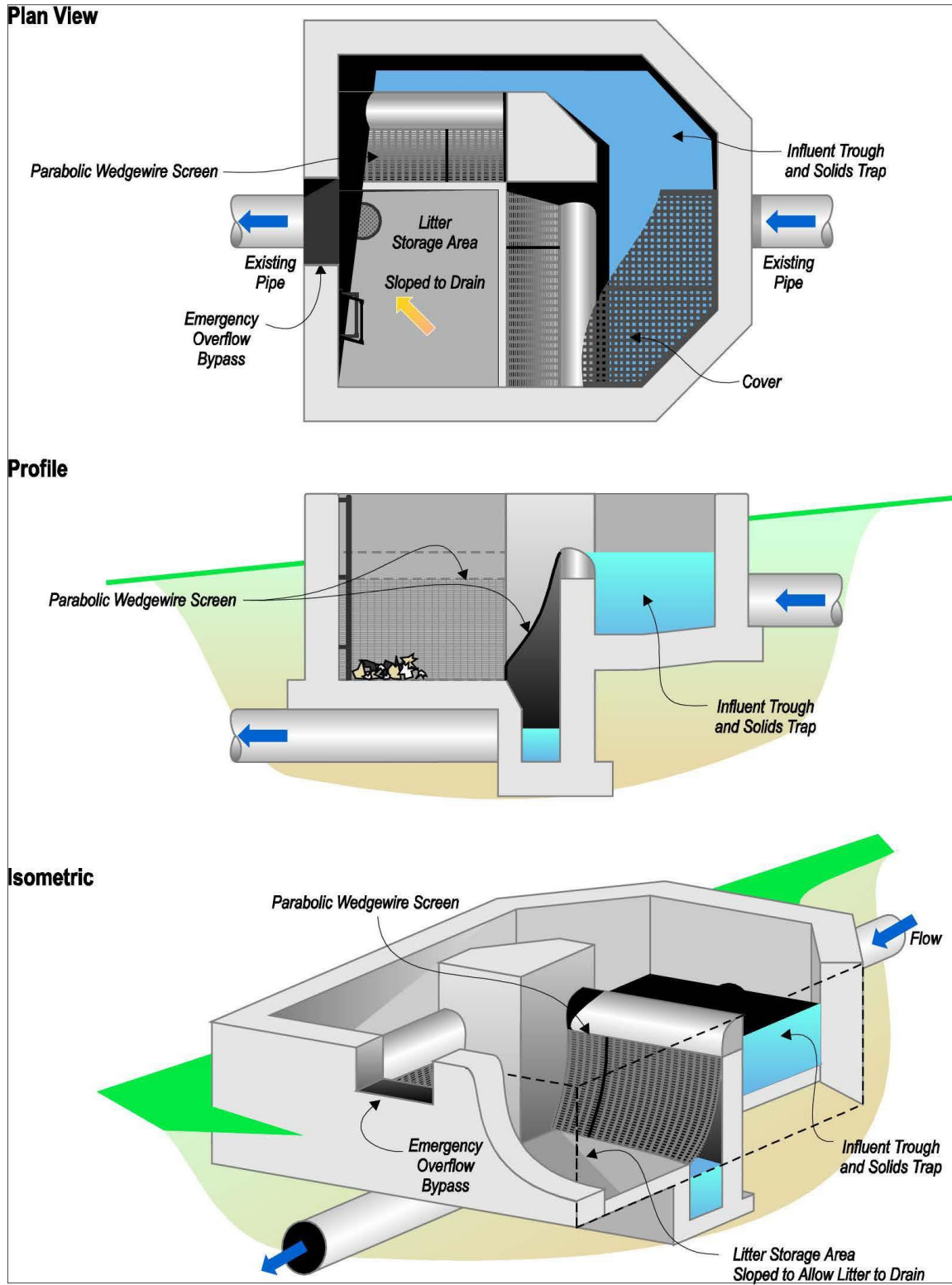

Figure C.23.6-4. Schematic of a Type 1 Inclined Screen Device

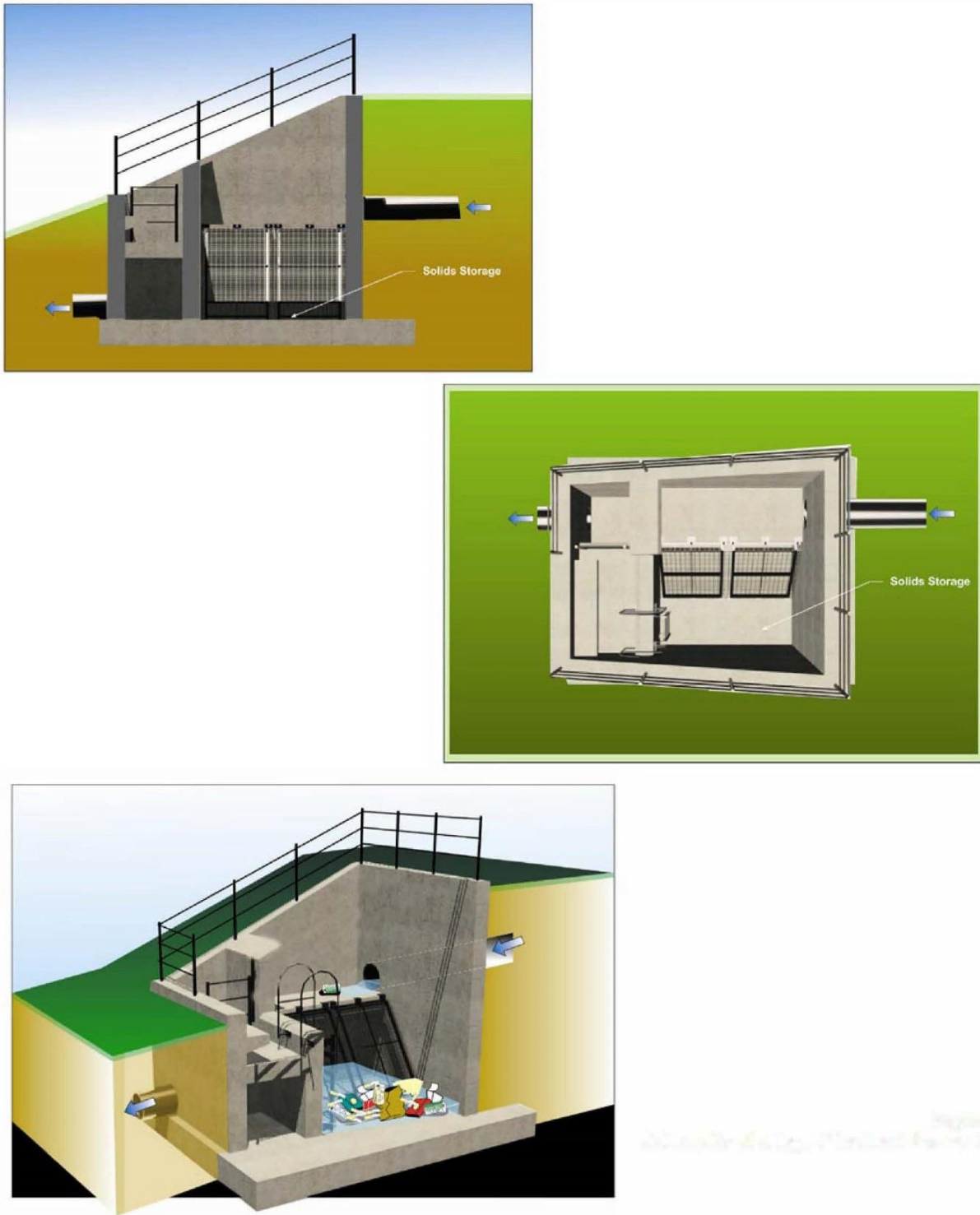

Figure C.23.6-5. Schematic of a Type 2 Inclined Screen Device

### C.23.7 Austin Media Filters



Figure C.23.7-1 Austin Media Filters

#### Description:

This BMP is intended to maintain Austin media filters as effective devices for treating runoff discharges. These requirements for regular inspection and maintenance will allow the devices to continue to function as designed.

#### Appropriate Applications:

The BMP maintenance activities described in Table C.23.7-1 apply to personnel who inspect and maintain Austin media filters. A schematic of an Austin Media Filter is shown in Figure C. 23.7-2.

#### Implementation:

Field measurements of maintenance indicators are made by visual observation. The figure below provides a graphical representation of the drain time threshold for standing water.

Table C. 23.7-1. Austin Media Filter Maintenance Activities

Maintenance Indicator	Inspection Frequency	Maintenance Activity
Drain time exceeds 72 hours	Annually, 3 days after a 0.75-inch storm event. If no such event occurs before April 1, conduct wet season inspections in April	<ul style="list-style-type: none"> <li>Remove sediment, trash and debris.</li> <li>For media filters with a standpipe, if standing water is upstream of the dividing wall, check orifice and unclog orifice at time of inspection.</li> <li>If standing water is over the filter bed, scarify with a rake at time of inspection. The top 2 inches of sand may need to be removed and disposed of if drain time continuously exceeds design time.<sup>1</sup> Contact the District Maintenance Storm Water Coordinator who will coordinate with appropriate staff regarding remediation.</li> <li>Restore top sand depth to original design depth after the sand filter depth is reduced by 6 inches<sup>1</sup></li> <li>Remove sand and filter fabric if necessary;</li> </ul>
Standing water for more than 96 hours	1 day after above inspection where standing water was observed and action taken.	Notify the District Maintenance Storm Water Coordinator/Vector Control District.
Sediment depth exceeds marker on staff gage in sedimentation basin; or sediment interferes with gravity drainage in standpipe and/or orifice plate	Annually during dry season.	Remove sediment prior to wet season. Characterize sediment as required and dispose properly.
Trash/debris present	Supervisors may set a schedule for debris and trash removal. Minimum is twice per year.	Remove and dispose of trash and debris per routine District schedule.
Burrows, holes, mounds	Annual inspections after vegetation trimming	Where burrows cause erosion or jeopardize structural integrity, backfill firmly.
Water accumulation in any structure or other location within the filter	Annually 3 days after a 0.75-inch storm event. If no such event occurs before April 1, conduct wet season inspections in April.	<ul style="list-style-type: none"> <li>Remove sediment, trash, and debris.</li> <li>Check orifice in standpipes, and check pump where applicable.</li> <li>Gravity drains where possible.</li> <li>If standing water cannot be removed within 96 hours or remains through wet season, notify the District Maintenance Storm Water Coordinator/Vector Control District.</li> </ul>
Inlet structures, outlet structures, filter fabric or other features hindered by debris or damaged, emergence of vegetation, graffiti or vandalism, fence damage, etc.	Semi-annually during the late wet season and late dry season	Within 30 working days, take corrective action for repairs and cleaning. Contact the District Maintenance Storm Water Coordinator if repairs /solutions are not readily available in the field. The District Maintenance Storm Water Coordinator will coordinate with appropriate staff for repairs/solutions.

<sup>1</sup> Refer to current Caltrans Standard Specifications and the latest Caltrans Stormwater Standard Special Provisions and Non-Standard Special Provisions (NSSPs) regarding replacement sand for Austin media filters

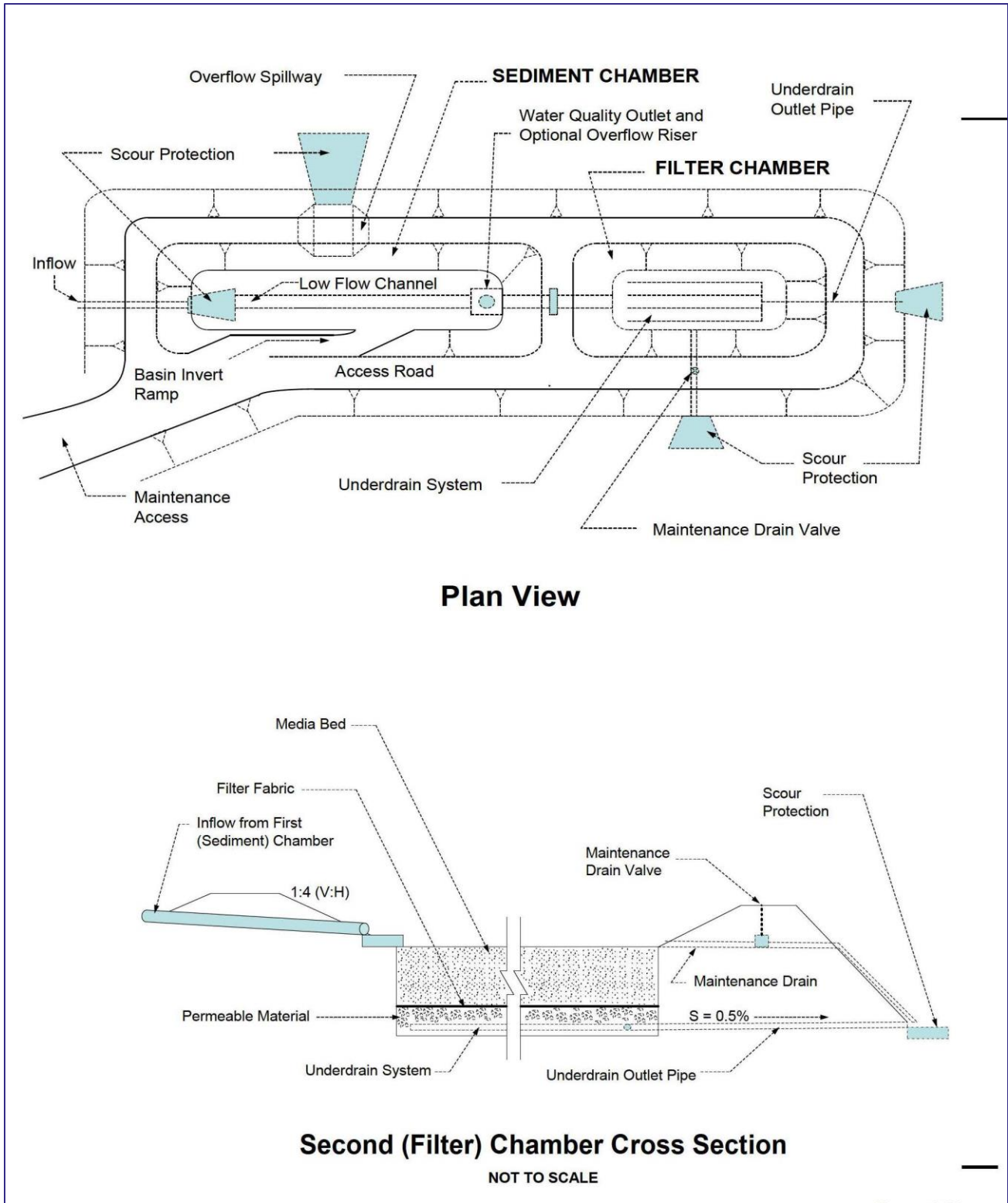

Figure C. 23.7-2. Schematic of an Austin Sand Filter



### C.23.8 Delaware Sand Filters



Figure C.23.8-1 Delaware Sand Filters

#### Description:

This BMP is intended to maintain Delaware sand filters as effective devices for treating runoff discharges. These requirements for regular inspection and maintenance will allow the devices to continue to function as designed.

#### Appropriate Applications:

The BMP maintenance activities described in Table C.23.8-1 apply to personnel who inspect and maintain Delaware sand filters. A schematic of a Delaware Sand Filter is shown in Figure C.23.8-2.

#### Implementation:

Field measurements of maintenance indicators are made by visual observation. The illustration below provides a graphical representation of the drain time threshold for standing water:

Table C.23.8-1. Delaware Sand Filter Maintenance Activities

Maintenance Indicator	Inspection Frequency	Maintenance Activity
Drain time exceeds 72 hours in the filter chamber	Annually, 3 days after a 0.75-inch storm event. If no such event occurs before April 1, conduct wet season inspections in April	<ul style="list-style-type: none"> <li>Remove sediment, trash and debris.</li> <li>Check orifice and pumps where applicable.</li> <li>The top 2 inches of media may need to be removed and disposed of if drain time continuously exceeds design time. Contact the District Maintenance Storm Water Coordinator who will coordinate with appropriate staff regarding remediation.</li> <li>If standing water cannot be removed, the Vector Control District must be notified.</li> <li><sup>2</sup>Restore media to original design depth</li> <li>Remove sand and filter fabric if necessary; Replacement sand and filter fabric shall conform to the latest stormwater Standard Special Provisions. Refer to Activity Cut-Sheet Page B-72.<sup>1</sup></li> </ul>
Sediment depth exceeds marker on staff gage in sedimentation basin	Annually during dry season	Remove sediment prior to wet season. Characterize sediment as required and dispose properly.
Trash/debris present	Supervisors may set a schedule for debris and trash removal. Minimum is twice per year.	Remove and dispose of trash and debris per routine District schedule.
Inlet structures, outlet structures, filter fabric or other features hindered by debris or damaged, emergence of vegetation, graffiti or vandalism, fence damage, etc.	Semi-Annually, late wet season and late dry season	Take corrective action for repairs and cleaning. Contact the District Maintenance Storm Water Coordinator if repairs / solutions are not readily available in the field. The District Maintenance Storm Water Coordinator will coordinate with appropriate staff for repairs/solutions.
Valve Leakage	Semi-annually, late wet season and late dry season	Tighten with wrench

<sup>1</sup> Refer to current Caltrans Standard Specifications and the latest Caltrans Stormwater Standard Special Provisions regarding replacement sand for Delaware media filters.



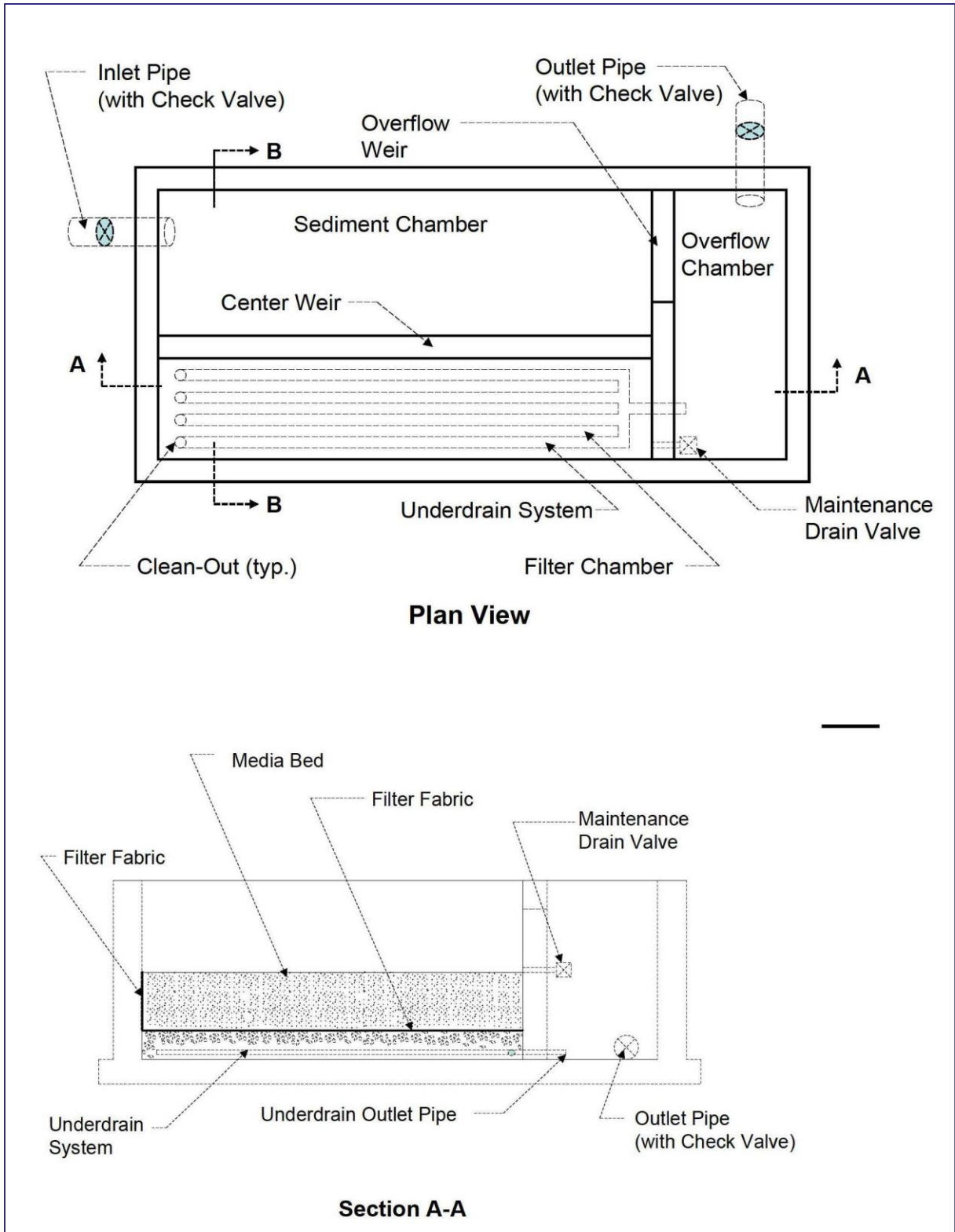

Figure C.23.8-2. Schematic of a Delaware Filter

### C.23.9. Multi-Chambered Treatment Train (MCTT)



Figure C.23.9-1 Multi-Chambered Treatment Train

#### Description:

This BMP is intended to maintain MCTTs as effective devices for treating runoff discharges. These requirements for regular inspection and maintenance will allow the devices to continue to function as designed.

#### Appropriate Applications:

The BMP maintenance described in Table C.23.9-1 and Table C.23.9-2 apply to personnel who inspect and maintain MCTT devices. The preventive maintenance routine is described in Table C.23.9-1 and the actual maintenance activities are described in Table C.23.9-2. A schematic of a MCTT is shown in Figure C.23.9-2 .

#### Implementation:

Field measurements of maintenance indicators are made by visual observation. The illustration below provides a graphical representation of the drain time threshold for standing water:

Table C-23.9-1 MCTT Preventative Maintenance		
Frequency	Routine Action	Activity Cut-Sheet Page
Annually in summer	Replace sorbent pillows in main settling chamber	B-72

Table C-23.9-2 MCTT Maintenance Activities		
Maintenance Indicator	Inspection Frequency	Maintenance Activity
Drain time through the filter chamber is greater than 72 hours or sediment accumulation is greater than 0.1 inch over more than 50 percent of the fabric surface area	Annually, 3 days after a 0.75-inch storm event. If no such event occurs before April 1, conduct wet season inspections in April.	<ul style="list-style-type: none"> <li>Remove and replace filter fabric blanket.<sup>1</sup></li> <li>If problem persists, notify the District Maintenance Storm Water Coordinator; the media may need to be replaced. Complete prior to wet season.</li> <li>Remove sand and filter fabric if necessary; Replacement sand and filter fabric shall conform to the latest stormwater Standard Special Provisions.<sup>1</sup> Remove, characterize, and properly dispose of sediment. Refer to Activity Cut-Sheet Page B-72.</li> </ul>
Standing water for more than 96 hours	1 day after above inspection where standing water was observed and action taken.	Notify the District Maintenance Storm Water Coordinator/Vector Control District.
Trash and debris present	Semi-Annually, late wet season and late dry season	Remove and dispose of trash and debris.
Sediment accumulates to 50% of the volume underneath the tube settlers (~6 inches). Maximum of 2-feet in grit chamber	Remove tube settler in sedimentation basin and plastic grate in grit chamber; measure sediment depth annually during the dry season	Remove sediment prior to wet season. Characterize sediment as required and dispose properly.
Water accumulation greater than 72 hours in any structure or other location within the device that is not protected from mosquito access <sup>2</sup>	Annually, 3 days after a 0.75-inch storm event. If no such event occurs before April 1, conduct wet season inspections in April.	Take action to drain standing water, such as removing accumulated sediment
Water accumulation greater than 96 hours in any structure or other location within the device that is not protected from mosquito access	1 day after above inspection where standing water was observed and action taken.	Notify the District Maintenance Storm Water Coordinator/Vector Control District. <sup>2</sup>
Operation greater than 9 years	Every 9 years	Remove and replace filter media. Characterize and properly dispose. <sup>1</sup>
Sorbent pillows in main settling chamber darkened by oily material	Annually, in summer	pillows are darkened by oily material; characterize and properly dispose.
Pump – storm status Indicator lights show Amber. Amber = pump failure Green=OK	Within 72 hours after every storm	Make assessment to determine if problem is electrical or mechanical. Take appropriate action. Replace pump if needed.
Pump-Warranty status	Annually in the dry season	Inspect pumps for serviceability and required periodic maintenance per manufacturer's guidelines
Inlet structures, outlet structures, pump status indicator lights, filter fabric, settling tubes, mosquito screen over sump pumps (if any), or other features hindered by debris or damaged, emergence of vegetation, graffiti or vandalism, fence damage, etc.	Semi-Annually, during wet season and late dry season	<ul style="list-style-type: none"> <li>Take corrective action prior to the wet season.</li> <li>Contact the District Maintenance Storm Water Coordinator if repairs /solutions are not readily available in the field. The District Maintenance Storm Water Coordinator will coordinate with appropriate staff for repairs/solutions.</li> </ul>

<sup>1</sup> Refer to current Caltrans Standard Specifications and the latest Caltrans Stormwater Standard Special Provisions regarding replacement sand for multi-chambered treatment train.

<sup>2</sup> At time of publication, all Caltrans MCTTs have covers that prevent mosquito access to permanent standing water features.

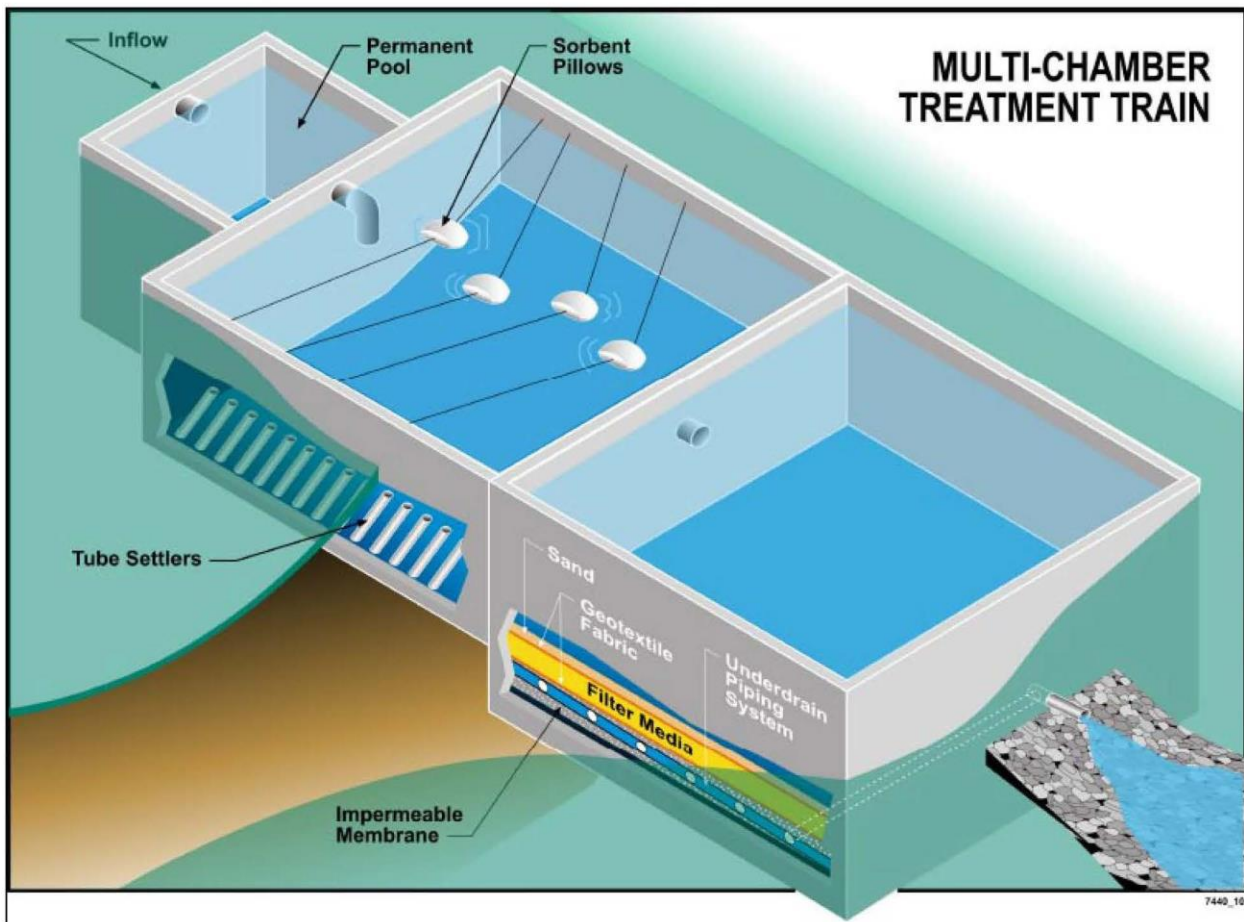

Figure C.23.9-2 Schematic of a Multi Chambered Treatment Train (MCTT)

### C.23.10 Wet Basin



Figure C.23.10-1 Wet Basin

#### Description:

This BMP is intended to maintain wet basin as effective devices for treating runoff discharges. These requirements for regular inspection and maintenance will allow the devices to continue to function as designed.

#### Appropriate Applications:

The BMP maintenance described in Table C.23.10-1 and Table C.23.10-2 apply to personnel who inspect and maintain wet basin devices. The preventive maintenance routine is described in Table C.23.10-1, and the actual maintenance activities are described in Table C.23.10-2. A schematic of a wet basin is shown in Figure C.23.10-1.

#### Implementation:

Field measurements of maintenance indicators are made by visual observation. The illustration below provides a graphical representation of the drain time threshold for standing water:

Table C. 23.10-1. Wet Basin Preventative Maintenance		
Frequency	Routine Action	Activity Cut-Sheet Page
Annually prior to dry season	Maintain vegetated access road to reduce fire hazard from contact with vehicle catalytic converters	B-56, B-72

Table C. 23.10-2. Wet Basin Maintenance Activities

Maintenance Indicator	Inspection Frequency	Maintenance Activity
Drawdown greater than 25 hours or water is flowing over weir	Once during wet season and after completion or modification of the facility. Inspect 25+ hours after 0.75-inch storm event.	<p>If drawdown is greater than 25 hours:</p> <ul style="list-style-type: none"> <li>• Open gate to discharge water to permanent pool elevation.</li> <li>• Clear outlet of debris.</li> <li>• Notify the District Maintenance Storm Water Coordinator.</li> </ul> <p>If water is spilling over weir, open canal gate until water level is at permanent pool elevation. Check/clear outlet of debris.</p>
Burrows, holes, mounds	Annually and after vegetation trimming	Where burrows cause erosion or jeopardize structural integrity, backfill firmly.
Inlet structures, outlet structures, side slopes or other features hindered by debris or damaged, significant erosion, graffiti or vandalism, fence damage, etc.	Semi-Annually, late wet season and late dry season	Take corrective action, or restore to as constructed condition prior to wet season. Contact the District Maintenance Storm Water Coordinator if repairs/solutions are not readily available in the field. The District Maintenance Storm Water Coordinator will coordinate with appropriate staff for repairs/solutions.
Observable vegetation coverage/density	Annually	<ul style="list-style-type: none"> <li>• Have a biologist survey the Wet Basin to determine if any birds are nesting or other sensitive animals are present. If birds are nesting, with advice from the biologist, proceed with the maintenance.</li> <li>• Lower and maintain the water level to expose the area to be maintained; do not completely drain basin.</li> <li>• Cut vegetation.</li> <li>• Dispose of the vegetation material in a landfill or other appropriate disposal area.</li> <li>• Restock mosquito fish as recommended by vector control agency.</li> </ul>
Vegetation density is such that mosquito fish cannot swim freely in the planted area	Annually, or at a special request of the local vector control district.	<ul style="list-style-type: none"> <li>• Have a biologist survey the Wet Basin to determine if any birds are nesting or other sensitive animals are present. If birds are nesting, with advice from the biologist, proceed with the maintenance.</li> <li>• Lower and maintain the water level to expose the area to be maintained; do not completely drain basin.</li> <li>• Cut the vegetation to below the permanent pool water surface.</li> <li>• Dispose of the vegetation material in a landfill or other appropriate disposal area.</li> </ul>

**Table C. 23.10-2. Wet Basin Maintenance Activities**

Sediment is more than 2 inches in the forebay and 4 inches in the main pond, or sediment depth exceeds marker on staff gage	When pond is drained for Zone 1 vegetation removal, or every 3 years	<ul style="list-style-type: none"> <li>• Remove and properly dispose of sediment. By November, restore vegetation to the plan shown on the as-built drawings.</li> <li>• Remove sediment accumulation in forebay and main pond. Refer to Activity Cut-Sheet Page B-72.</li> </ul>
---	--	---



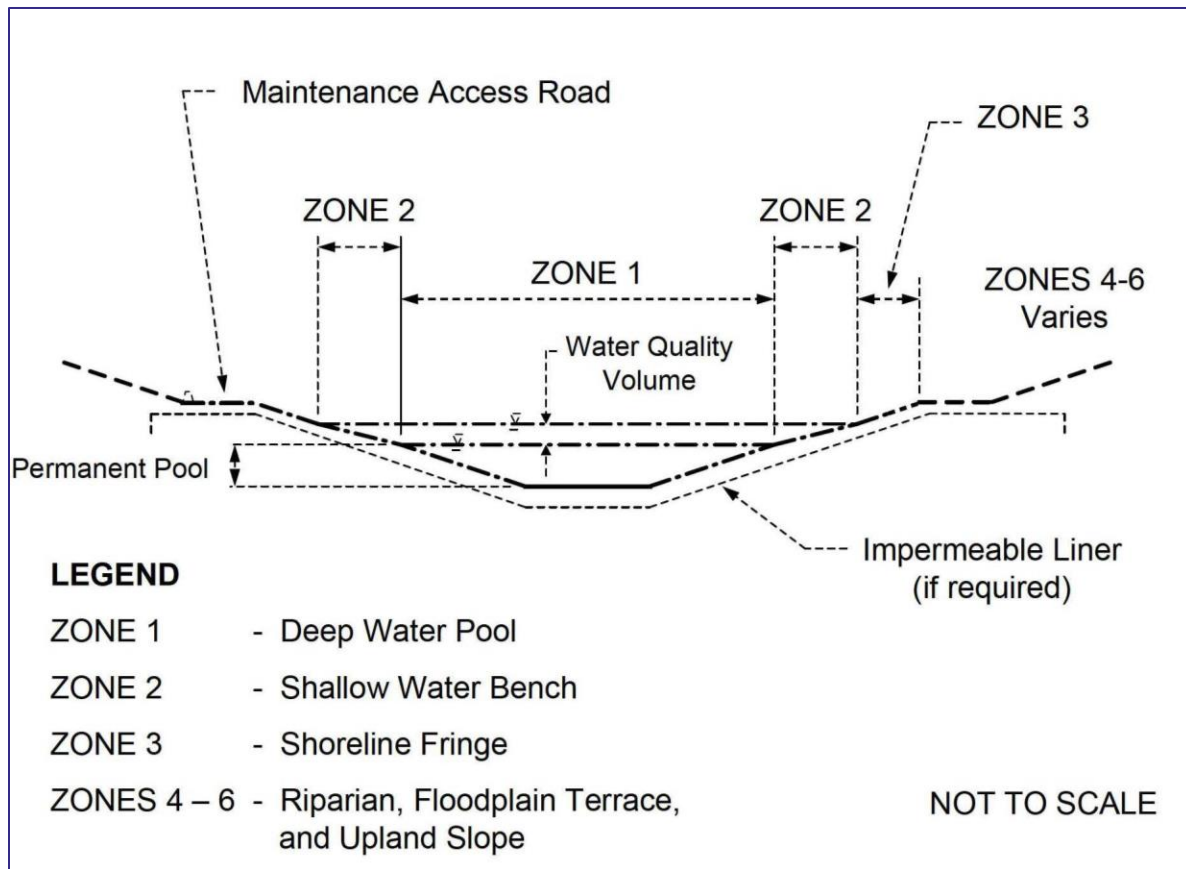

Figure C. 23.10-1 Schematic of a Wet Basin

### C.23.11 Design Pollution Prevention (DPP) Infiltration Areas



Figure C.23.11-1 DPP Infiltration Areas

#### Description:

DPP Infiltration Areas are a type of treatment system consisting of vegetated and non-vegetated pervious land areas that promote infiltration of stormwater runoff. DPP Infiltration Areas can be located adjacent to impervious areas to allow stormwater runoff to flow over the area as sheet flow and may also convey concentrated flows (e.g., rock lined ditch).

#### Appropriate Application:

The BMP maintenance described in Table C.23.11-1 and Table C.23.11-2 apply to personnel that inspect and maintain DPP Infiltration Areas. Swales tend to have higher water depths than strips, so preventive and corrective maintenance for maintaining plant vegetation height should be implemented.

The preventive maintenance routine is described in Table C23.11-1, and the corrective maintenance activities are described in Table C.23.11-2.

**Table C-23.11.2-1. DPP Infiltration Area Preventative Maintenance**

Frequency	Routine Action	Activity Cut-Sheet Page
Annually	E Family - Landscaping	B-56, B-58, B-72
	Investigate vegetative health	Inspect BMP for dead or diseased vegetation and remove and replant as needed. Replace with drought tolerant and flood tolerant plants.
	Replace mulch	Add/replace mulch. Mulch within the BMP can be prone to floating, so traditional wood chips alone should not be used. Use aged mulch, also called compost mulch, which can be obtained through soil suppliers or directly from commercial recycling yards. It is recommended to apply 1" to 2" of composted mulch, once a year, preferably in June following weeding.
	Rock	Inspect rock used, clean sediment accumulation.

Table C-23.11-2. DPP Infiltration Area Maintenance Activities

Maintenance Indicator	Inspection Frequency	Maintenance Activity
Drain time exceeds 96 hours after end of rain event	Annually, 3 days after a 0.75-inch storm event. If no such event occurs before April 1, conduct wet season inspections in April	<ul style="list-style-type: none"> <li>Remove sediment, trash and debris.</li> <li>Notify the District Maintenance Stormwater Coordinator/Vector Control District.</li> </ul>
Trash/debris present	Supervisors may set a schedule for debris and trash removal. Minimum is twice per year.	Remove and dispose of trash and debris per routine District schedule.
Erosion	During dry season	Cracking of soils or degrading slopes may be corrected by placing additional topsoil or mulch, increasing planting, or adding energy dissipaters.
Burrows, holes, mounds	Annual inspection after vegetation trimming	Where burrows cause erosion or jeopardize structural integrity, backfill firmly.
Sediment depth exceeds marker on staff gage or sediment interferes with gravity drainage	Annually during dry season.	<p>Remove sediment prior to wet season. Characterize sediment as required and dispose properly.</p> <p>Adjust marker on staff gage as necessary to ensure sediment depth is below depth required to maintain 96 hour drain time and capture design water quality volume.</p>
Inlet structures, outlet structures, filter fabric or other features hindered by debris or damaged, emergence of vegetation, graffiti or vandalism, fence damage, etc.	Semi-annually during the late wet season and late dry season	Take corrective action for repairs and cleaning. Contact the District Maintenance Storm Water Coordinator if repairs /solutions are not readily available in the field. The District Maintenance Storm Water Coordinator will coordinate with appropriate staff for repairs/solutions.

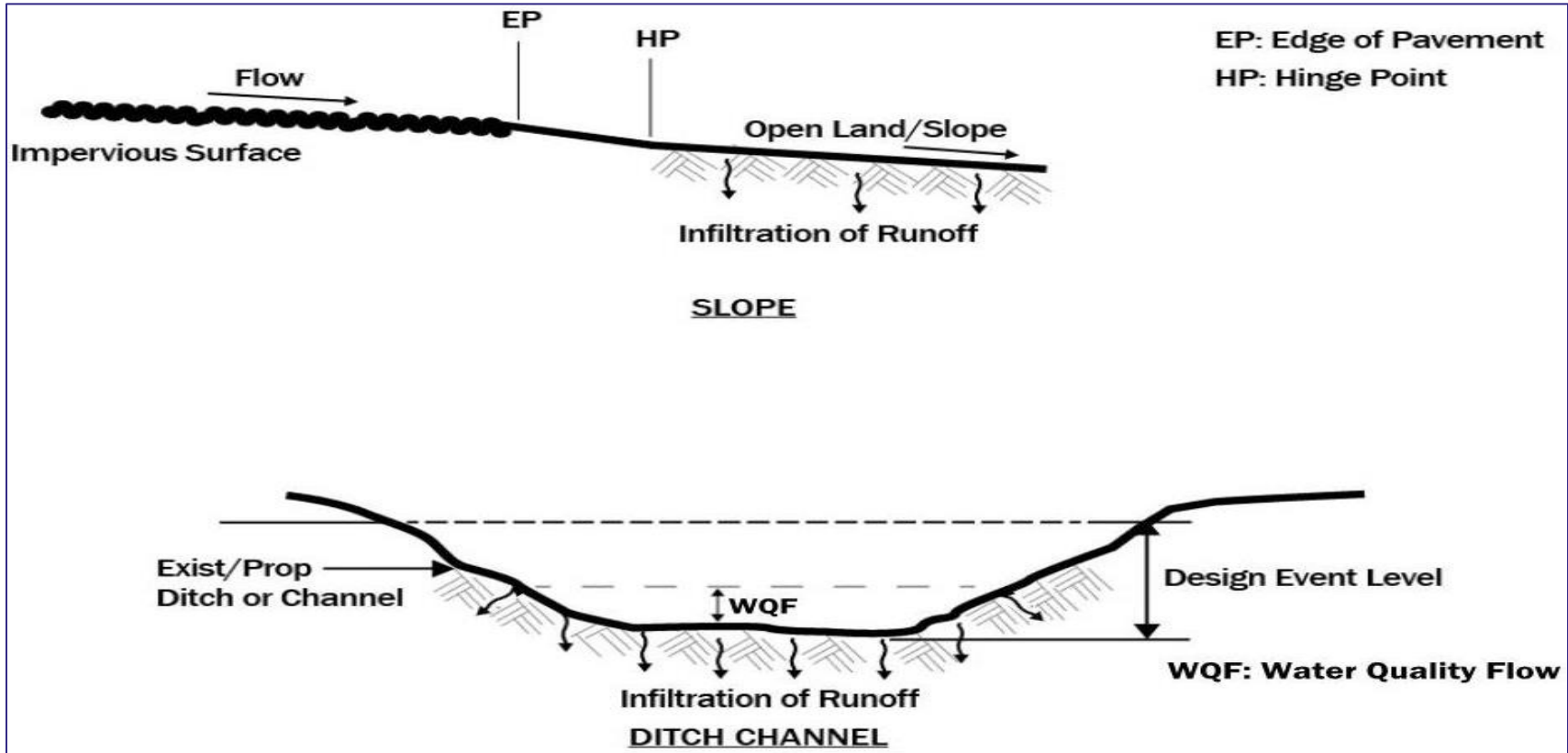

Figure C.23.11-2 Schematic of an DPP Infiltration Areas

### C.23.12 Bioretention



Figure C-23.12-1. Bioretention Cell

#### Description:

Bioretention cells consist of vegetated depressions that treat runoff by filtering through mulch and soil-based media.

#### Application:

Bioretention cells reduce peak discharge and runoff volume by detaining water through surface ponding and storage in soil and gravel layers, and by allowing it to infiltrate into the subsoil.

These measures are intended to maintain established bioretention BMPs as effective devices for treating runoff discharges. These requirements for inspection and maintenance will allow the devices to continue to function as designed for water quality purposes.

Table C.23-12-1 Bioretention Filter Preventative Maintenance

Frequency	Routine Action	Activity Cut-Sheet Page
Annually	E Family - Landscaping	B-56, B-58, B-72
	Investigate vegetative health	Inspect BMP for dead or diseased vegetation and remove and replant as needed. Replace with drought tolerant and flood tolerant plants.
	Replace mulch	Add/replace mulch. Mulch within the BMP can be prone to floating, so traditional wood chips alone should not be used. Use aged mulch, also called compost mulch, which can be obtained through soil suppliers or directly from commercial recycling yards. It is recommended to apply 1" to 2" of composted mulch, once a year, preferably in June following weeding.
	Inspect and flush2 underdrains and conveyance piping	Inspect underdrain system for broken caps and replace as needed. Flush underdrains and piping with high water pressure using clean out access. Underdrains and conveyance piping will accumulate with sediment and debris.

Table C.23-12-2 Bioretention Filter Maintenance Activities

Maintenance Indicator	Inspection Frequency	Maintenance Activity
Drain time exceeds 96 hours after end of rain event	Annually, 3 days after a 0.75-inch storm event. If no such event occurs before April 1, conduct wet season inspections in April	<ul style="list-style-type: none"> <li>Remove sediment, trash and debris.</li> <li>For bioretention filters with a standpipe, check orifice and unclog orifice at time of inspection.</li> <li>Notify the District Maintenance Stormwater Coordinator/Vector Control District.</li> </ul>
Trash/debris present	Supervisors may set a schedule for debris and trash removal. Minimum is twice per year.	Remove and dispose of trash and debris per routine District schedule.
Erosion	During dry season	Cracking of soils or degrading slopes may be corrected by placing additional topsoil or mulch, increasing planting, or adding energy dissipaters.
Burrows, holes, mounds	Annual inspection after vegetation trimming	Where burrows cause erosion or jeopardize structural integrity, backfill firmly.
Sediment depth exceeds marker on staff gage in sedimentation basin; or sediment interferes with gravity drainage in standpipe and/or orifice plate	Annually during dry season.	<p>Remove sediment prior to wet season. Characterize sediment as required and dispose properly.</p> <p>Adjust marker on staff gage as necessary to ensure sediment depth is below depth required to maintain 96 hour drain time and capture design water quality volume.</p>



Table C.23-12-2 Bioretention Filter Maintenance Activities

<p>Inlet structures, outlet structures, filter fabric or other features hindered by debris or damaged, emergence of vegetation, graffiti or vandalism, fence damage, etc.</p>	<p>Semi-annually during the late wet season and late dry season</p>	<p>Take corrective action for repairs and cleaning. Contact the District Maintenance Storm Water Coordinator if repairs /solutions are not readily available in the field. The District Maintenance Storm Water Coordinator will coordinate with appropriate staff for repairs/solutions.</p>
<p>As Needed</p>	<p>Inspect and flush1 underdrains and conveyance piping Inspect pumps, drainage systems, and inlet trenches</p>	<p>Inspect underdrain system for broken caps and replace as needed. Flush underdrains and piping with high water pressure using clean out access. Underdrains and conveyance piping will accumulate with sediment and debris.  In areas prone to saltwater intrusion, monitor corrosion of pumps (if present), drainage systems, and inlet trenches.</p>

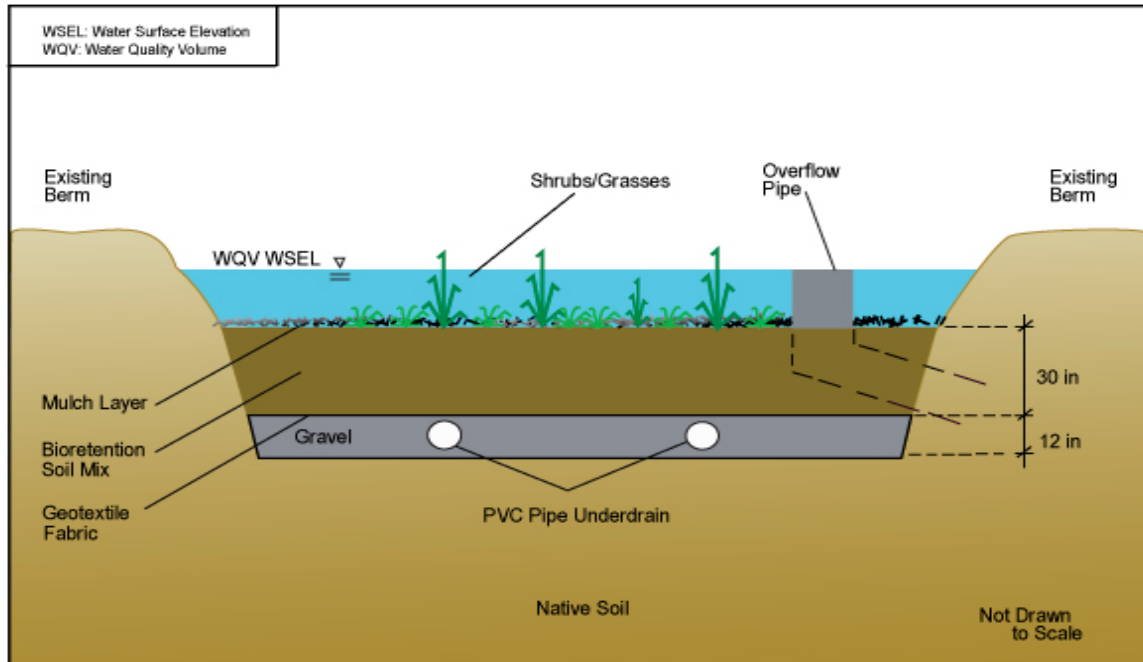

Figure C-23.12-2. Schematic of a Bioretention Cell

### C.23.13 Open Graded Friction Course (OGFC)



Figure C.23.13-1 Open Graded Friction Course

#### Description:

Open Graded Friction Course (OGFC) is a sacrificial wearing course that consists of aggregate with relatively uniform grading and little or no fine aggregate and mineral filler. It has a large number of void spaces in the compacted mix.

Designed to reduce skid and hydroplaning accidents by draining surface water through its voids structure, OGFC also filters pollutants from pavement runoff and drains the water off the edge of traveled way as treatment.

#### Appropriate Application:

OGFC should not be used on areas that are snow or icy, prone to oil and fuel dripping, bridge decks, with severe turning movements, and muddy or sandy. The BMP maintenance activities described in Table C-79 apply to personnel who inspect and maintain OGFC. A schematic of an OGFC is shown in Figure C-27.

#### Implementation:

Maintenance of proper high void structure limits the use of OGFC to a last resort option if other treatment BMPs are not feasible. It is important for field personnel to identify OGFC areas installed as treatment BMPs to spot maintenance indicators made by visual observation.

#### Maintenance:

Section 4 of the Open Graded Friction course contain the maintenance requirements. The site can be found at <http://www.dot.ca.gov/hq/esc/Translab/ormt/pdf/FrictionCourseGuide.pdf>.

Generally, only removal and replacement is allowed for repairing a failed or aged OGFC.

Table C.23-13 Open Grade Friction Course Maintenance Activities

Maintenance Indicator	Inspection Frequency	Maintenance Activity
Cracking, raveling, delamination, clogging and other failure of overlay.	Routine roadway pavement inspection may be conducted annually. Maintenance may observe for clogging during rain events.	Notify district engineer and District Maintenance Storm Water Coordinator for contracted repairs.

**Table C.23-13 Open Grade Friction Course Maintenance Activities**

		<p>Only removal and replacement with OGFC is allowed for repairing a failed or aged OGFC.                  Proceed to decommission the OGFC if not effective in filtering runoff.</p>
--	--	---

Maintenance activities on roadways surfaced with OGFC should avoid obstructing the lateral flow of water through the OGFC. These activities may include crack sealing or patching a small failed area with DGAC, thus creating a dam where water may be retained or stored and contribute to further failure of the OGFC surfacing.

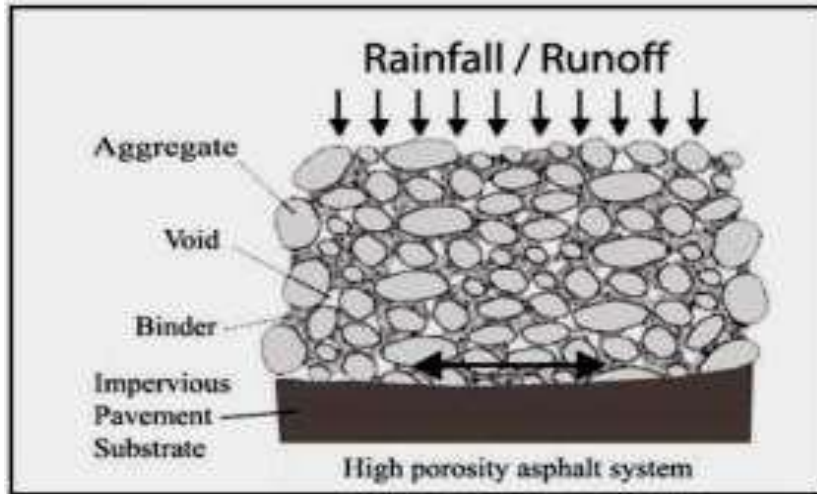

Figure C.23.13-2 Open Graded Friction Course

## C.24 Litter and Debris Removal

Litter and debris removal consists of removing and properly disposing of Litter and Debris implementing procedures to discourage littering to reduce the discharge of potential pollutants. Litter and Debris removal BMPs include:

- C.24.1 Litter and Debris BMP
- C.24.2 Anti-Litter Signs

### C.24.1 Litter and Debris



Figure 24.1-1 Litter and Debris Collection

#### Description:

These measures are intended to reduce the discharge of litter to stormwater drainage systems or watercourses.

#### Appropriate Applications:

This BMP should be implemented on a site-specific basis whenever litter and debris removal activities are performed. The frequency of removal is dependent on the availability of resources, safety considerations and rate of accumulation.

#### Implementation:

- Remove litter and debris when necessary to reduce and/or eliminate discharge to the stormwater drainage systems and watercourses.
- Remove illegal encampments and other illegal dumpsites from within the right of way in accordance with Maintenance Policy Directive Number 1001 Illegal Encampments.
- Secure or cover transported materials, equipment and supplies to and from maintenance activity sites to prevent spillage to the roadway.
- Prioritize cleanup of areas with high trash accumulation and nearby receiving waterbodies.
- Protect from precipitation outdoor storage of trash and debris.

## C.24.2 Anti-Litter Signs



Figure C.24.2-1 Anti-Litter Sign

### Description:

Caltrans conducts a signage program that warns against dumping and littering (e.g., “No Dumping” and “\$1,000 Fine for Littering”). These signs are placed along highways where littering violations are frequent. The purpose of this program is to discourage littering by educating motorists about the fine for littering.

The Adopt A Highway Program is being conducted in accordance with the Caltrans NPDES Permit requirements. The campaign implements proven strategies, including media advocacy, special events, partnerships, paid media and community outreach, to raise the level of awareness of the effects of littering and encourage the public to avoid littering.

### Appropriate Applications:

Anti-litter signs may be placed:

- Along highway corridors that receive an unsightly amount of litter.
- Along freeways, safety roadside rest areas, vista points and park-and-ride facilities.

### Implementation:

Maintenance Supervisors travel highways in their assigned section to observe overall conditions and assess the need for litter removal and installation of anti-litter signs. Anti-litter signs can be requested when litter removal becomes a concern.



## C.25 Chemical Vegetation Control

### Description:

This practice is intended to reduce the potential for the discharge of pollutants generated during chemical vegetation control. This method of vegetation control uses herbicides to eliminate and prevent weed growth. The purpose is to control weed growth that may threaten the growth and health of preferred vegetation, that may become a fire hazard or raise other safety concerns.

### Appropriate Applications:

The BMPs should be implemented on a site-specific basis whenever chemical vegetation control activities are performed. Chemical vegetative control measures will not be used on vegetated TBMPs (see C.23 Structural Treatment System Maintenance) except where Caltrans is directed by the California Department of Food and Agriculture to treat the BMPs for invasive weeds. Caltrans will report the use of these required chemicals in its Annual Report.

### Implementation:

- Caltrans has an Integrated Vegetation Management Plan that integrates manual, chemical, mechanical, cultural and biological methods to provide the most effective pest management approach.
- Caltrans follows an approved list of chemicals developed by Maintenance Headquarters that is generally more restrictive than herbicide use options available to other agencies and the public.
- The Caltrans goal is to reduce chemical usage.
- To achieve effective vegetation control through chemical application, maintenance personnel should consider the following: use of the correct herbicide, seasonal timing of applications, timing in relation to expected precipitation events, proximity to water bodies, wind speed, speed of travel when applying herbicides and proper agitation of the spray tank.
- Apply herbicides in compliance with federal, state and local pesticide use regulations.
- Apply herbicides only as specified on the “Pesticide Use Recommendation” and the label.
- Activities should be approved by a licensed Agricultural Pest Control Adviser.
- Apply herbicides as recommended in the District Annual Vegetation Control Plan.
- Minimize and where possible eliminate the use of herbicides near stormwater drainage systems or watercourses.
- Calibrate the spray rig to ensure accurate application of herbicides.
- Avoid using overhead irrigation for as long as the chemical manufacturer recommends after applying post emergent herbicides.
- Unless allowed by the label directions, do not spray chemicals when rainfall causing runoff is forecasted.
- Herbicide use should be documented and summarized in the Annual Report.

## C.26 Slopes Prone to Erosion and Sediment Discharge



Figure C.26-1 Slopes Prone to Erosion and Sediment Discharge

### Description:

Districts have established Maintenance Inspection/Slope Stabilization Teams to review vegetated slopes. The program will identify problematic slopes for repair to reduce erosion.

### Appropriate Application:

Slope inspections are conducted along all roadsides at least once during an established 5-year schedule. Areas with recurring problems should be inspected as needed

### Implementation:

- Minor slides and slipouts requiring a Maintenance Division response shall be inspected and evaluated at the time of response field activities. Roadsides found to be of significant concern will be inspected on a more frequent basis depending on site conditions. In addition, all newly completed slopes resulting from construction projects are inspected on a more frequent basis up to one year after project completion.
- Slope repairs that are within the abilities of the Maintenance Inspection/Slope Stabilization Team should be repaired by that team. The Districts will prioritize stabilization efforts for those slopes most prone to erosion based on the following criteria:
  - Priority 1: Storm drains on highway segments in areas prone to erosion that are within Environmentally Sensitive Areas (ESAs)
  - Priority 2: Storm drains on highway segments in ESAs including impaired waterbodies
  - Priority 3: Storm drains on highway segments in areas prone to erosion

Areas prone to erosion are highway slopes where major and minor slide, slip removal or repair activities were conducted for three consecutive years.

- Road segments that do not meet one or more of the above criteria will be assigned lower priorities for slope stabilization than those segments that do meet one or more of the above criteria.

- Each District will establish a multi-disciplinary team to review problem slopes. Problem slopes with erosion concerns that cannot be repaired by the Maintenance Inspection/Slope Stabilization Team should be reported to the multi-disciplinary team. These projects should be forwarded to the State Highway Operation and Protection Program for possible funding and repair.
- Caltrans uses a standard reporting form for recording inspection findings and identifying recommended repairs. Slides and slip-outs encountered during routine surveillance and inspections are evaluated for repair. Recommendations are developed for site-specific remedial measures to maintain slope and soil stability. Remedial measures can range from minor grading or seeding to installation of major slope stabilization systems.

## C.27 Snow Removal and De-Icing Agents



Figure C.27-1 Snow Removal

### Description:

This BMP is intended to reduce the discharge of potential pollutants generated during ice control activities. Ice control activities include:

- The mechanical spreading of abrasives and de-icing agents;
- The mechanical removal of snow from the travel way;
- Opening of drains covered by snow and ice; and
- Opening of roads that are normally allowed to close for the winter season.

### Appropriate Applications:

- This BMP provides guidance to maintenance personnel who are involved in snow and ice removal activities. The use or nonuse of de-icing agents is based on driver safety, traffic delay, geographic location, weather and total cost.
- In areas of the state where significant amounts of abrasives are required, the sweeping frequency should be increased to remove accumulated abrasives.

### Implementation:

- Calibrate spreader to avoid the over-application of de-icing agents or abrasives. Use no more than is necessary for snow and ice control. Consider using alternative de-icing agents where runoff from roads discharges directly to sensitive watercourses.
- Maintain accurate records of the locations of de-icing agents and abrasives application and the quantities of de-icing agents and abrasives used.
- Store de-icing agents (e.g., salt) in appropriate areas, bunkers or storage buildings. Do not store de-icing agents where they will come into contact with stormwater runoff.

- Abrasives (e.g., sand and cinders) can be stored in bunkers or storage buildings. Abrasives stored outdoors must be managed in accordance with the requirements of C.17 Stockpile Management BMP.
- Avoid blowing, pushing or dumping snow into the watercourse.

## C.28 Stormwater Dewatering Operations (Temporary Pumping Operations)



Figure C.28-1 Dewatering Operation

### Description:

These practices are implemented where stormwater is pumped. This BMP addresses discharge from portable pumps used by maintenance personnel during repairs and to prevent damage to the highway.

### Appropriate Applications:

These practices are implemented where stormwater is pumped as part of a maintenance activity. Note that per Section 5 of the Statewide SWMP, some discharges are exempt or conditionally exempt.

### Implementation:

Ensure that dewatering discharges do not cause erosion, scour or sedimentary deposits at the discharge point and surface.

Pumping systems should be equipped with screens on the intake.

Intakes should be located to reduce the pumping of sediment. Pumping areas near the stormwater surface often contain less sediment than areas near the bottom.

Sediment Control BMPs may be installed at intake or outlet locations to trap excessive sediment.

Do not discharge stormwater or non-stormwater that has an odor, discoloration other than sediment, an oily sheen, or foam on the surface. Notify your supervisor immediately upon discovering any such condition.

### Maintenance:

Inspect all BMPs implemented frequently and repair or replace to ensure the BMPs function as designed.



Accumulated sediment removed during the maintenance of a dewatering device may be incorporated in the maintenance activity site or disposed in accordance with Section C.13.2 Solid Waste Management BMP.

Accumulated sediment that is commingled with other pollutants must be disposed of in accordance with Section C.13.2 Solid Waste Management BMP and C.13.3 Hazardous Waste Management BMP.



## C.29 Sweeping and Vacuuming



Figure C.29-1 Caltrans Sweeping Operations

### Description:

Sweeping and vacuuming are performed to remove litter, debris and de-icing abrasives from paved roads and shoulders. Sweeping to reduce track-out generally involves manual sweeping or use of small equipment but does not exclude the use of sweepers should the need arise (e.g., for slides and slipouts).

### Appropriate Applications:

Sweeping and vacuuming operations are appropriate for removing de-icing abrasives, material from small slides, litter and debris.

Sweeping and vacuuming may be implemented anywhere sediment is tracked from off-road maintenance activity sites onto public or private paved roads typically at the points of egress (see Section C.12.1 Stabilized Activity Entrance/Exit BMP).

### Implementation:

#### Highway Sweeping:

Do not sweep up any unknown substance that may be potentially hazardous. If a substance is known to be hazardous, suspected of being hazardous or cannot be identified, notify the District Maintenance HazMat Manager immediately. If an illegally dumped substance within the Department's Right of Way has the potential of entering a municipal drain system, the immediate supervisor and the District Storm Water Coordinator must be notified so that the downstream municipality can be contacted.

Adjust brooms to maximize the efficiency of sweeping operations.

Do not load hoppers beyond their capacity.

Dispose of waste to a landfill or approved site in accordance with local regulations and Section C.13.2, Solid Waste Management BMP. There is to be no dumping on site, especially during the rainy season or during unseasonal storm events to abate wash out. Clean materials may be incorporated into the maintenance activity area.

**Tracking Control:**

Substantially visible sediment shall be swept or vacuumed from the maintenance activity site.

If not mixed with debris or trash, consider incorporating the removed sediment back into the maintenance activity site.

Washing and rinsing of equipment shall be performed in designated areas and in accordance with C.15.1 Vehicle and Equipment Cleaning.

Protect drain inlets during sweeping operations

## C.30 Maintenance Facility Housekeeping Practices



Figure C.30.1 Maintenance Facility Housekeeping Practices

### Description:

Daily activities occurring at maintenance facilities often involve the use of materials and products that are potentially harmful to the environment. Good housekeeping practices are intended to eliminate the potential for discharge of pollutants to drainage paths, stormwater drainage systems or watercourses by promoting efficient and safe storage, use and cleanup of potentially harmful materials.

### Appropriate Applications:

Proper housekeeping practices apply to all maintenance personnel who participate in activities that have a potential to generate pollutants that could discharge to stormwater drainage systems or watercourses.

### Implementation:

- Maintain clean, orderly material and equipment storage areas. Provide covers for materials as needed.
- Use the 'first in first out' policy for material storage and control. Avoid ordering more materials than can be stored properly or used in a reasonable timeframe.
- Properly reuse, recycle or dispose of empty containers, excess materials, equipment and parts that are not likely to be used. All solid wastes shall be managed per the requirements of the C.13.2 Solid Waste Management BMP.
- Maintain equipment and buildings to avoid peeling paint, rust and degradation. Request funding for major repairs.
- Sweep or vacuum maintenance facility floors and pavement.
- If mopping is used to clean floors or pavement, contain the mop water and dispose of it to the sanitary sewer system according to the following guidelines:
  - Do not dispose of mop water into the parking lot, street, gutter or drain inlet; and
  - If an oil/water separator is available, pour the mop water into the separator so that the wastewater is treated before being discharged to the sanitary sewer system.

- Secure and close lids on waste receptacles and bins when not in use.
- Clean up spills promptly. See C.13.1, Spill Prevention and Control BMP.
- Use drip pans or absorbent material under leaking vehicles and equipment to capture fluids.
- If it is necessary to use a hose for cleaning, wash water shall not be discharged to the stormwater drainage systems or watercourses.
- Minimize the possibility of stormwater pollution from outdoor waste receptacles by doing at least one of the following:
  - Use only watertight waste receptacle(s) and keep the lid(s) closed;
  - Grade and pave the waste receptacle area to prevent run-on of stormwater;
  - Install a roof over the waste receptacle area;
  - Install a low containment berm around the waste receptacle area; or
  - Use and maintain drip pans under waste receptacles.