

CHAPTER 500 – TRAFFIC INTERCHANGES

Topic 501 – General

Index 501.1 – Concepts

A traffic interchange is a combination of ramps and grade separations at the junction of two or more highways for the purpose of reducing or eliminating traffic conflicts, to improve safety, and increase traffic capacity. Crossing conflicts are reduced by grade separations. Turning conflicts are either eliminated or minimized, depending upon the type of interchange design.

501.2 Warrants

All connections to freeways are by traffic interchanges. An interchange or separation may be warranted as part of an expressway (or in special cases at the junction of two non-access controlled highways), to improve safety or eliminate a bottleneck, or where topography does not lend itself to the construction of an intersection.

501.3 Spacing

The minimum interchange spacing shall be one mile in urban areas, two miles outside of urban areas, and two miles between freeway-to-freeway interchanges and other interchanges. The minimum interchange spacing on Interstates outside of urban areas shall be three miles. These distances are the centerline measurement of crossroad-to-crossroad spacing. To improve operations of closely spaced interchanges the use of auxiliary lanes, grade separated ramps, collector-distributor roads, and/or ramp metering may be warranted.

The standards contained within this Index apply to:

- New interchanges.
- Modifications or replacement of an existing interchange structure that results in a change to the centerline measurement of crossroad-to-crossroad spacing.
- Projects to increase mainline capacity when existing interchanges do not meet interchange spacing requirements.

See Index 504.7 for additional technical requirements related to interchange spacing, based on entrance ramp-to-exit ramp spacing.

Topic 502 – Interchange Types

502.1 General

The selection of an interchange type and its design are influenced by many factors including the following: speed, volume, and composition of traffic to be served (e.g., trucks, vehicles,

July 1, 2020

bicycles, and pedestrians), number of intersecting legs, and arrangement of the local street system (e.g., traffic control devices, topography, right of way controls), local planning, proximity of adjacent interchanges, community impact, and cost.

The cost of a structure is a considerable investment where the life of a structure may be 50 to 100 years, far beyond that of the project traffic study projections. New or significant modifications to interchanges should take into consideration future needs of the system; the ultimate configuration for the freeway and the potential for local land development well beyond the 20-year traffic study. Choose an interchange type that is compatible with or can easily be modified to accommodate the future growth of the system.

Even though interchanges are designed to fit specific conditions and controls, it is desirable that the pattern of interchange ramps along a freeway follow some degree of consistency. It is frequently desirable to rearrange portions of the local street system in connection with freeway construction in order to affect the most desirable overall plan for mobility and community development.

Interchange types are characterized by the basic shapes of ramps: namely, diamond, loop, directional, hook, or variations of these types. Many interchange designs are combinations of these basic types. Schematic interchange patterns are illustrated in Figure 502.2 and Figure 502.3. These are classified as: (a) Local street interchanges and (b) Freeway-to-freeway interchanges. See AASHTO, A Policy on Geometric Design of Highways and Streets, for additional examples.

502.2 Local Street Interchanges

The Department's philosophy for highway design has evolved over time. DD-64 Complete Streets, DP-22 Context Sensitive Solutions, DP-05 Multimodal Alternatives and other policies and guidance are a result of that evolution in design philosophy. No longer are freeway interchanges designed with only the needs of motorists in mind. Pedestrian and bicycle traffic needs are to be considered along with the motorized traffic. Local road interchanges ramp termini should be perpendicular to the local road. The high speed, shallow angle, ramp termini of the past are problematic for pedestrians and bicyclists to navigate. Vehicle speeds are reduced by the right angle turn, allowing drivers to better respond to bicycle and pedestrian conflicts. For new construction or major reconstruction consideration must be given to orienting ramps at right angles to local streets. For freeways where bicycles are permitted to use the freeway, ramps need to be designed so that bicyclists can exit and enter the freeway without crossing the higher speed ramp traffic. See Index 400 for type, design, and capacity of intersections at the ramp terminus with the local road.

An interchange is expected to have an on- and off-ramp for each direction of travel. If an off-ramp does not have a corresponding on-ramp, that off-ramp would be considered an isolated off-ramp. **Isolated off-ramps or partial interchanges shall not be used because of the potential for wrong-way movements.** In general, interchanges with all ramps connecting with a single cross street are preferred.

Figure 502.2

Typical Local Street Interchanges

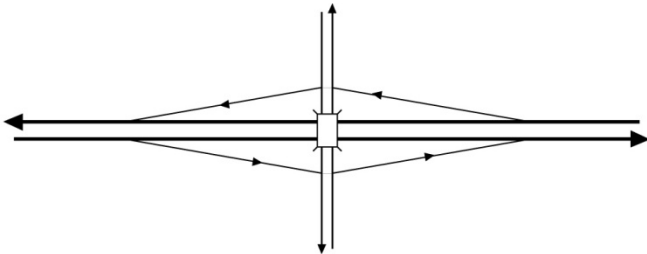

TYPE L-1

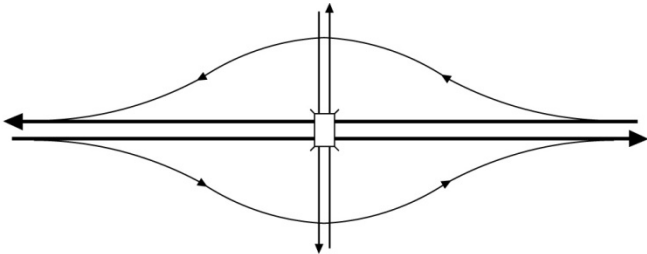

TYPE L-2

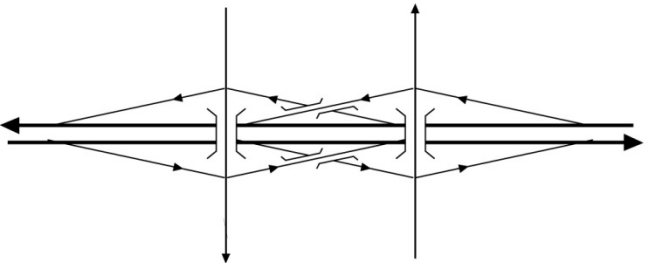

TYPE L-3

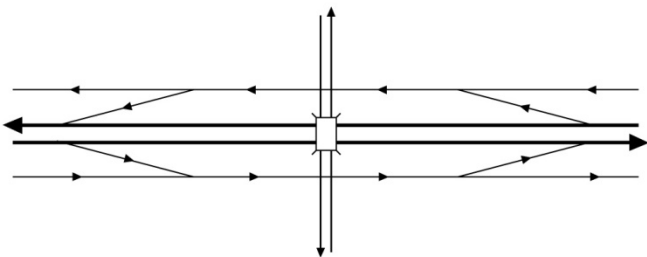

TYPE L-4

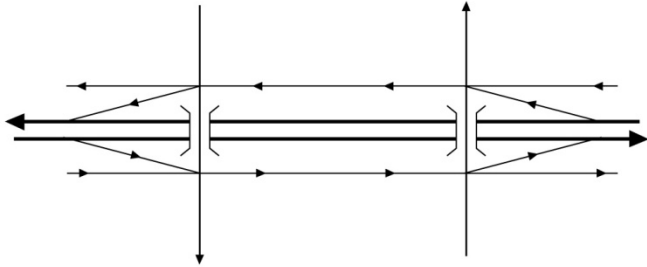

TYPE L-5

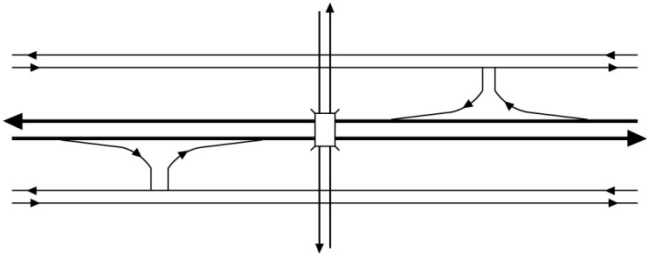

TYPE L-6

July 1, 2020

Figure 502.2

Typical Local Street Interchanges (Cont.)

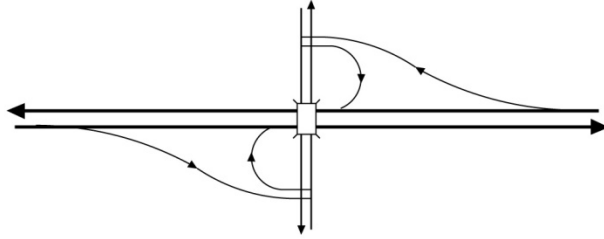

TYPE L-7

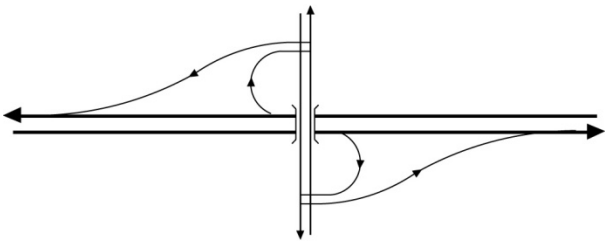

TYPE L-8

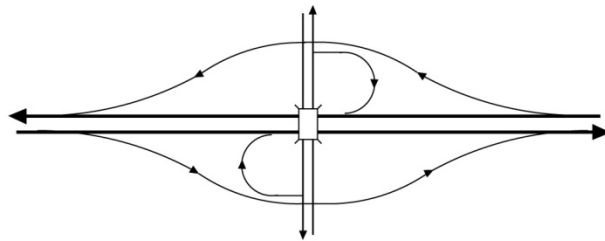

TYPE L-9

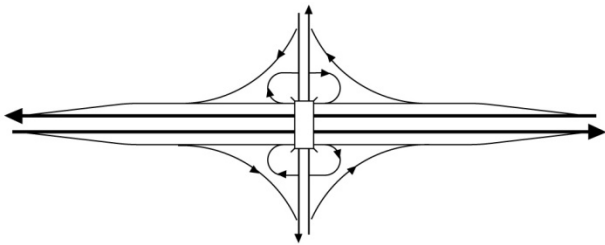

TYPE L-10

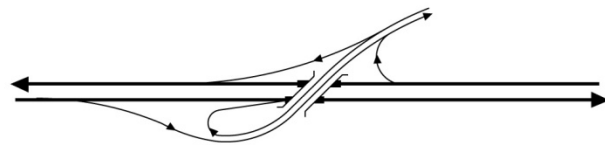

TYPE L-11

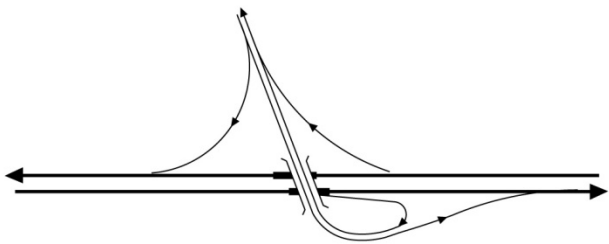

TYPE L-12

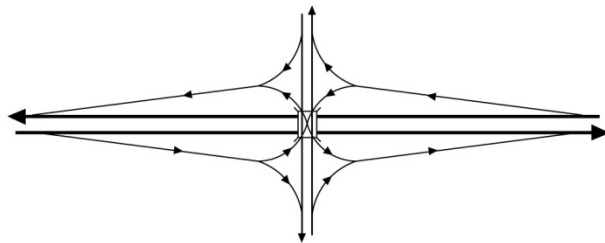

TYPE L-13

At local road interchanges it is preferable to minimize elevation changes on the local road and instead elevate or depress the freeway. Such designs have the least impact on those users most affected by the elevation changes, such as pedestrians and bicyclists.

Class II bikeways designed through interchanges should be accomplished considering the mobility of bicyclists and should be designed in a manner that will minimize confusion by motorists and bicyclists. Designs which allow high speed merges at on- and off-ramps to local streets and conventional highways have a large impact on bicycle and pedestrian mobility and should not be used. Designers should work closely with the Local Agency when designing bicycle facilities through interchanges to ensure that the shoulder width is not reduced through the interchange area. If maintaining a consistent shoulder width is not feasible, the Class II bikeway must end at the previous local road intersection. A solution on how to best provide for bicycle travel to connect both sides of the freeway should be developed in consultation with the Local Agency and community as well as with the consideration of the local bicycle plan.

- (a) Diamond Interchange. The simplest form of interchange is the diamond. Diamond interchanges provide a high standard of ramp alignment, direct turning maneuvers at the crossroads, and usually have minimum construction costs. The diamond type is adaptable to a wide range of traffic volumes, as well as the needs of transit, bicyclists, and pedestrians. The capacity is limited by the capacity of the intersection of the ramps at the crossroad. This capacity may be increased by widening the ramps to two or three lanes at the crossroad and by widening the crossroad in the intersection area. Crossroad widening will increase the length of undercrossings and the width of overcrossings, thus adding to the bridge cost. Roundabouts may provide the necessary capacity without expensive crossroad widening between the ramp termini. Ramp intersection capacity analysis is discussed in Topic 406.

The compact diamond (Type L-1) is most adaptable where the freeway is depressed or elevated and the cross street retains a straight profile. Type L-1's are suitable where physical, geometric or right of way restrictions do not permit a spread diamond configuration. Compact diamonds have the disadvantage of requiring wider overcrossing or longer span undercrossing to provide corner sight distance and have limited capacity between intersections. Once the area around the interchange is developed, Type L-1 is challenging to expand to accommodate growth.

The spread diamond (Type L-2) is adaptable where the grade of the cross street is changed to pass over or under the freeway. The ramp terminals are spread in order to achieve maximum sight distance and minimum intersection cross slope, commensurate with construction and right of way costs, travel distance, and general appearance. A spread diamond has the advantage of flatter ramp grades, greater crossroads left-turn storage capacity, and the flexibility of permitting the construction of future loop ramps if required.

The split diamond with braids (Type L-3) may be appropriate where two major crossroads are closely spaced.

- (b) Interchanges with Parallel Street Systems. Types L-4, L-5 and L-6 are interchange systems used where the freeway alignment is placed between parallel streets. Types L-4 and L-5 are used where the parallel streets will operate with one-way traffic. In Type L-4 slip ramps merge with the frontage street and in Type L-5 the ramps terminate at the intersection of the frontage road with the cross street, forming five-legged intersections. In Type L-6 the freeway ramps connect with two-way parallel streets. The parallel streets in the Types L-4, L-5 and L-6 situation are usually too close to the freeway to permit ramp intersections on the cross street between the parallel frontage streets.

The "hook" ramps of the Type L-6 are often forced into tight situations that lead to less than desirable geometrics. The radius of the curve at the approach to the intersection should

July 1, 2020

exceed 150 feet and a tangent of at least 150 feet should be provided between the last curve on the ramp and the ramp terminal.

Special attention should always be given to exit ramps that end in a hook to ensure that adequate sight distance around the curve, adequate deceleration length prior to the curve or end of anticipated queue, and adequate superelevation for anticipated driving speeds can be developed. Type L-6 can only be considered when all other interchange types are not acceptable.

- (c) Cloverleaf Interchanges. The simplest cloverleaf interchange is the two-quadrant cloverleaf, Type L-7 or Type L-8, or a combination where the two loops are on the same side of the cross street. Type L-7 eliminates the need for left-turn storage lanes, on or under the structure, thus reducing the structure costs. These interchanges should be used only in connection with controls which preclude the use of diamond ramps in all four quadrants. These controls include right of way controls, a railroad track paralleling the cross street, and a short weaving distance to the next interchange.

The Type L-9, partial cloverleaf interchange, provides loop on-ramps in addition to the four diamond-type ramps. This interchange is suitable for large volume turning movements. Left-turn movements from the crossroads are eliminated, thereby permitting two-phase operation at the ramp intersections when signalized. Because of this feature, the Type L-9 interchange usually has capacity to handle the higher volume traffic on the crossroad.

The four-quadrant cloverleaf interchange (Type L-10) offers free-flow characteristics for all movements. It has the disadvantage of a higher cost than a diamond or partial cloverleaf design, as well as a relatively short weaving section between the loop ramps which limits capacity. For this reason this type of interchange is not desirable. Collector-distributor roads should be incorporated in the design of four-quadrant cloverleaf interchanges to separate the weaving conflicts from the through freeway traffic.

- (d) Trumpet Interchanges. A trumpet design, Type L-11 or L-12, may be used when a crossroads terminates at a freeway. This design should not be used if future extension of the crossroads is probable. The diamond interchange is preferable if future extension of the crossroads is expected.
- (e) Single Point Interchange (SPI). The Type L-13 is a concept which essentially combines two separate diamond ramp intersections into one large at-grade intersection. It is also known as an urban interchange. Additional information on SPI's is provided in DIB 92 "Single Point Interchange Guidelines."

Type L-13 requires approximately the same right of way as the compact diamond. However, the construction cost is substantially higher due to the structure requirements. The capacity of the L-13 can exceed that of a compact diamond if long signal times can be provided and left turning volumes are balanced.

This additional capacity may be offset if nearby intersection queues interfere with weaving and storage between intersections. The disadvantages of the L-13 are: 1) future expansion of the interchange is extremely difficult; 2) stage construction for retrofit situations is costly; 3) long structure spans require higher than normal profiles and deeper structure depths; and 4) longer bicycle and pedestrian circulation.

- (f) Other Types of Interchanges. New or experimental interchanges must have the Project Delivery Coordinator and the Headquarters Chief, Division of Traffic Operations concurrence before selection. Concurrence may require additional studies and documentation.

502.3 Freeway-to-Freeway Interchanges

- (1) *General.* The function of the freeway-to-freeway interchange is to link freeway segments together so as to provide the highest level of service in terms of mobility. Parameters such as cost, environment, community values, traffic volumes, route continuity, driver expectation and safety should all be considered. Route continuity, providing for the designated route to continue as the through movement through an interchange, reduces lane changes, simplifies signing, and reduces driver confusion.

Interstate routes shall maintain route continuity. Where both the designated route and heavier traffic volume route are present, the interchange configuration shall keep the designated route to the left through the interchange.

- (2) *Design Considerations.*

- (a) *Cost.* The differential cost between interchange types is often significant. A cost-effective approach will tend to assure that an interchange is neither over nor underdesigned. Decisions as to the relative values of the previously mentioned parameters must be consistent with decisions reached on adjacent main line freeways.
- (b) *System Balance.* The freeway-to-freeway interchange is a critical link in the total freeway system. The level of traffic service provided will have impact upon the mobility and overall effectiveness of the entire roadway system. For instance, traffic patterns will adjust to avoid repetitive bottlenecks, and to the greatest degree possible, to temporary closures, accidents, etc. The freeway-to-freeway interchange should provide flexibility to respond to these needs so as to maximize the cost effectiveness of the total system.
- (c) *Provide for all Traffic Movements.* All interchanges must provide for each of the eight basic movements (or four basic movements in the case of a three-legged interchange), except in the most extreme circumstances. Less than “full interchanges” may be considered on a case-by-case basis for applications requiring special access for managed lanes (e.g., transit, HOVs, HOT lanes) or park and ride lots. Partial interchanges usually have undesirable operational characteristics. If circumstances exist where a partial interchange is considered appropriate as an initial phase improvement, then commitments need to be included in the request to accommodate the ultimate design. These commitments may include purchasing the right of way required during the initial phase improvements.
- (d) *Local Traffic Service.* In metropolitan areas a freeway-to-freeway interchange is usually superimposed over an existing street system. Local and through traffic requirements are often in conflict.

Combinations of local and freeway-to-freeway interchanges can result in designs that are both costly and so complex that the important design concepts of simplicity and consistency are compromised. Therefore, alternate plans separating local and freeway-to-freeway interchanges should be fully explored. Less than desirable local interchange spacing may result; however, this may be compensated for by upgrading the adjacent local interchanges and street system.

Local traffic service interchanges should not be located within freeway-to-freeway interchanges unless geometric standards and level of service will be substantially maintained.

- (e) *Alignment.* It is not considered practical to establish fixed freeway-to-freeway interchange alignment standards. An interchange must be designed to fit into its environment. Alignment is often controlled by external factors such as terrain, buildings, street patterns, route adoptions, and community value considerations. Normally, loops have radii in the range of 150 feet to 200 feet and direct connections should have

July 1, 2020

minimum radii of 850 feet. Larger radii may be proper in situations where the skew or other site conditions will result in minimal increased costs. Direct connection radii of at least 1,150 feet are desirable from a traffic operational standpoint. High alignment and sight distance standards should be provided where possible.

Drivers have been conditioned to expect a certain standard of excellence on California freeways. The designer's challenge is to provide the highest possible standards consistent with cost and level of service.

(3) *Types*. Several freeway-to-freeway interchange design configurations are shown on Figure 502.3. Many combinations and variations may be formed from these basic interchange types.

(a) *Four-Level-Interchange*. Direct connections are appropriate in lieu of loops when required by traffic demands or other specific site conditions. The Type F-1 interchange with all direct connections provides the maximum in mobility and safety. However, the high costs associated with this design require that the benefits be fully substantiated.

The Type F-1 Alternative "A" interchange utilizes a single divergence ramp for traffic bound for the other freeway; then provides a secondary directional split. Each entrance ramp on a Type F-1A interchange is provided separately. The advantages of the Type F-1A are: 1) reduced driver confusion since there is only one exit to the other freeway, and 2) operations at the entrance may be improved since the ramps merge with the mainline one at a time.

The Type F-1 Alternative "B" interchange provides separate directional exit ramps and then merges the entering traffic into a single ramp before converging with the mainline. Since the Type F-1B combines traffic from two ramps before entering the freeway, it is important to verify that adequate weaving capacity is provided beyond the entrance. Separating the directional split of exiting traffic reduces the volume to each of the two ramps and therefore may improve the level of service of the weave section prior to the exit.

Design for a four-level interchange may combine the configuration of the Type F1-A and F1-B interchange to best suit the conditions at a given location.

(b) *Combination Interchanges*. The three-quadrant cloverleaf, Type F-2, with one direct connection may be necessary where a single move carries too much traffic for a loop ramp or where the one quadrant is restricted by environmental, topographic, or right of way controls.

The two-loop, two-direct connection interchange, Type F-3, is often an appropriate solution. The weaving conflicts which ordinarily constitute the most restrictive traffic constraint are eliminated, yet cost and right of way requirements may be kept within reasonable bounds. Consideration should be given to providing an auxiliary lane in advance of the loop off-ramps to provide for vehicle deceleration.

(c) *Four-Quadrant Cloverleaf*. The four-quadrant cloverleaf with collector-distributor roads, Type F-4, is ordinarily the most economical freeway-to-freeway interchange solution when all turning movements are provided. The four-quadrant cloverleaf is generally applicable in situations where turning volumes are low enough to be accommodated in the short weaving sections. It should be designed with collector-distributor roads to separate weaving conflicts from the through freeway traffic.

(d) *Freeway Terminal Junction*. Types F-5, F-6, F-7, and F-8 are examples of interchange designs where one freeway terminates at the junction with another freeway. In general, the standard of alignment provided on the left or median lane connection from the terminating freeway should equal or approach as near as possible that of the terminating

Figure 502.3

Typical Freeway-to-freeway Interchanges

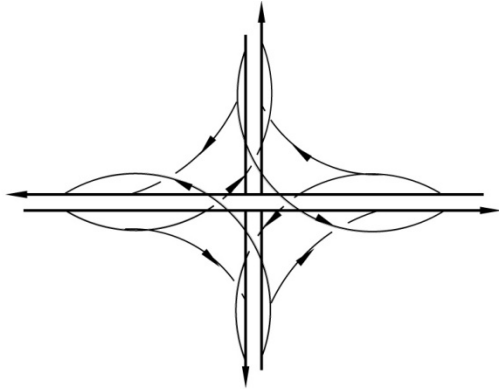

TYPE F-1 (ALT "A")

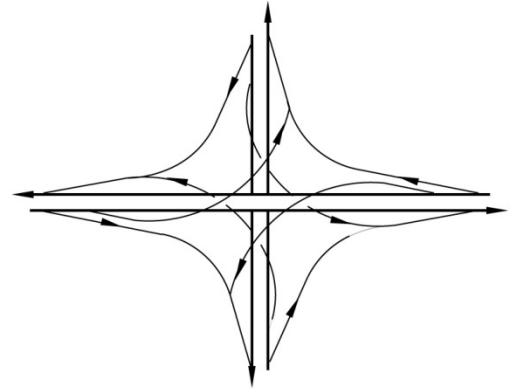

TYPE F-1 (ALT "B")

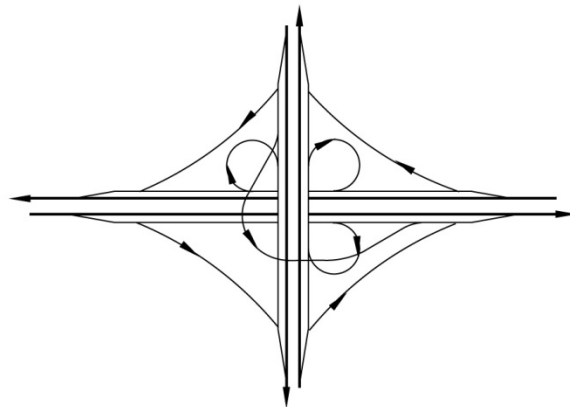

TYPE F-2

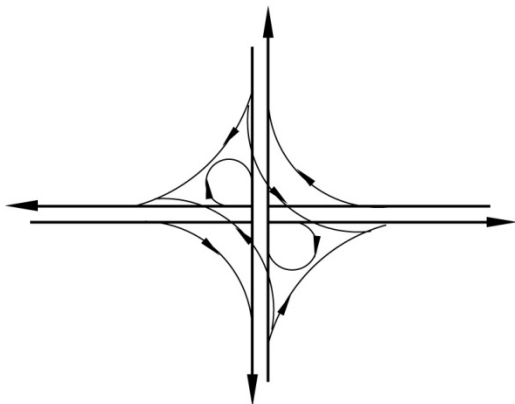

TYPE F-3

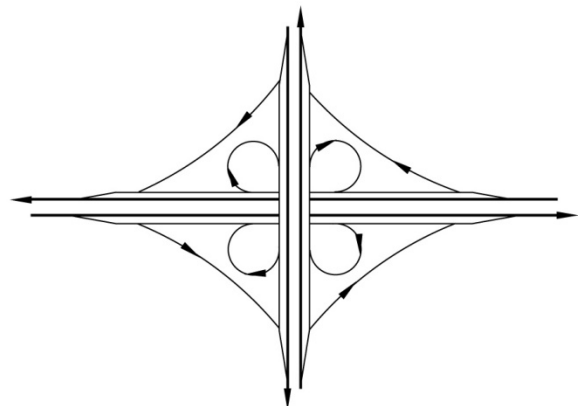

TYPE F-4

July 1, 2020

Figure 502.3

Typical Freeway-to-freeway Interchanges (Cont.)

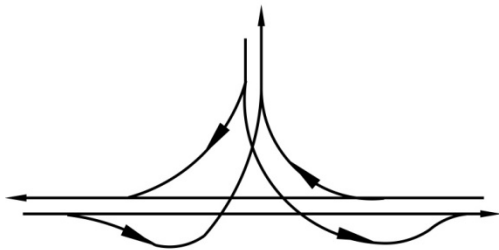

TYPE F-5

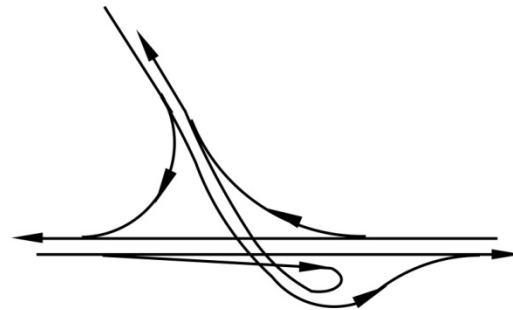

TYPE F-6

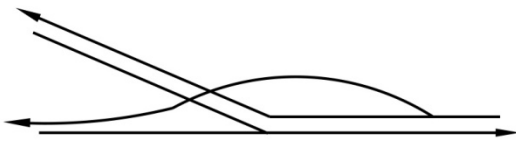

TYPE F-7



TYPE F-8

freeway. Terminating the median lane on a loop should be avoided. It is preferable that both the designated route and the major traffic volume be to the left at the branch connection diverge. The choice between Types F-7 and F-8 should include considerations of traffic volumes, and route continuity. When these considerations are in conflict, the choice is made on the basis of judgment of their relative merits.

Topic 503 – Interchange Design Procedure

503.1 Basic Data

Data relative to community service, traffic, physical and economic factors, and potential area development which may materially affect design, should be obtained prior to interchange design. Specifically, the following information should be available:

- (a) The location and standards of existing and proposed local streets including types of traffic control.
- (b) Existing, proposed and potential for development of land, including such developments as employment centers, retail services and shopping centers, recreational facilities, housing developments, schools, and other institutions.
- (c) A vehicle traffic flow diagram showing average daily traffic and design hourly volumes, as well as time of day (a.m. or p.m.), anticipated on the freeway ramps and affected local streets or roads.
- (d) Current and future bicycle and pedestrian access through the community.
- (e) The relationship with adjacent interchanges.
- (f) The location of major utilities, railroads, or airports.
- (g) The presence of dedicated lanes and associated ramps and connections, including HOV lanes, Bus (BRT) lanes and Express lanes.
- (h) The planned ultimate build-out for the freeway facility.
- (i) Existing and planned rail facilities.

503.2 Reviews

Interchanges are among the major design features which are to be reviewed by the Project Delivery Coordinator and/or District Design Liaison, District Traffic Engineer or designee, other Headquarters staff, and the FHWA Transportation Engineer, as appropriate. Major design features include the freeway alignment, geometric cross section, geometric design and intersection control of ramp termini, location of separation structures, closing of local roads, frontage road construction, bicycle and pedestrian facilities and work on local roads. Particularly close involvement should occur during preparation of the project initiation document and project report (see the Project Development Procedures Manual). Such reviews can be particularly valuable when exceptions to design standards are being considered and alternatives are being sought. The geometric features of all interchanges or modifications to existing interchanges must be approved by the Project Delivery Coordinator.

Topic 504 – Interchange Design Standards

504.1 General

Topic 504 discusses the standards that pertain to both local service interchanges (various ramp configurations) and freeway-to-freeway connections. The design standards, policies and practices covered in Indexes 504.2, and 504.5 through 504.8 are typically common to both ramp and connector interchange types. Indexes 504.3 and 504.4 separately discuss ramp standards and freeway-to-freeway connector standards, respectively.

504.2 Freeway Entrances and Exits

- (1) ***Basic Policy.*** All freeway entrances and exits, except for direct connections with median High-Occupancy Vehicle (HOV) lanes, Express Toll lanes or BRT lanes, shall connect to the right of through traffic.

July 1, 2020

- (2) *Standard Designs.* Design of freeway entrances and exits should conform to the standard designs illustrated in Figure 504.2A-B (single lane), and Figure 504.3K (two-lane entrances and exits) and/or Figure 504.4 (diverging branch connections), as appropriate.

The minimum deceleration length shown on Figure 504.2B shall be provided prior to the first curve beyond the exit nose to assure adequate distance for vehicles to decelerate before entering the curve. The same standard should apply for the first curve after the exit from a collector-distributor road. The range of minimum "DL" (distance) vs. "R" (radius) is given in the table in Figure 504.2B. Strong consideration should be given to lengthening the "DL" distance given in the table when the subsequent curve is a descending loop or hook ramp, or if the upstream condition is a sustained downgrade (see AASHTO, A Policy on Geometric Design of Highways and Streets, for additional information).

The exit nose shown on Figure 504.2B may be located downstream of the 23-foot dimension; however, the maximum paved width between the mainline and ramp shoulder edges should be 20 feet. Also, see pavement cross slope requirements in Index 504.2(5).

Contrasting surface treatment beyond the gore pavement should be provided on both entrance and exit ramps as shown on Figures 504.2A, 504.2B, and 504.3K. This treatment can both enhance aesthetics and minimize maintenance efforts. It should be designed so that a driver will be able to identify and differentiate the contrasting surface treatment from the pavement areas that are intended for regular or occasional vehicular use (e.g., traveled way, shoulders, paved gore, etc.).

Consult with the District Landscape Architect, District Materials Engineer, and District Maintenance Engineer to determine the appropriate contrasting surface treatment of the facility at a specific location.

Refer to the HOV Guidelines for additional information specific to direct connections to HOV lanes.

- (3) *Location on a Curve.* Freeway entrances and exits should be located on tangent sections wherever possible in order to provide maximum sight distance and optimum traffic operation. Where curve locations are necessary, the ramp entrance and exit tapers should be curved also. The radius of the exit taper should be about the same as the freeway edge of traveled way in order to develop the same degree of divergence as the standard design (see Figure 504.2C).

On entrance ramps the distance from the inlet nose (14-foot point) to the end of the acceleration lane taper should equal the sum of the distances shown on Figure 504.2A. The 50:1 (longitudinal to lateral) taper may be curved to fit the conditions, and the 3,000-foot radius curve may be adjusted (see Figure 504.2A, note 3).

When an exit must be located where physical restrictions to visibility cannot be corrected by cut widening or object removal, an auxiliary lane in advance of the exit should be provided. The length of auxiliary lane should be a minimum 600 feet, 1,000 feet preferred.

- (4) *Design Speed Considerations.* In the design of interchanges it is important to provide vertical and horizontal alignment standards which are consistent with driving conditions expected on branch connections. Sight distance on crest vertical curves should be consistent with expected approach speeds.

- (a) *Freeway Exit*—The design speed at the exit nose should be 50 miles per hour or greater for both ramps and branch connections.

Figure 504.2A

Single Lane Freeway Entrance

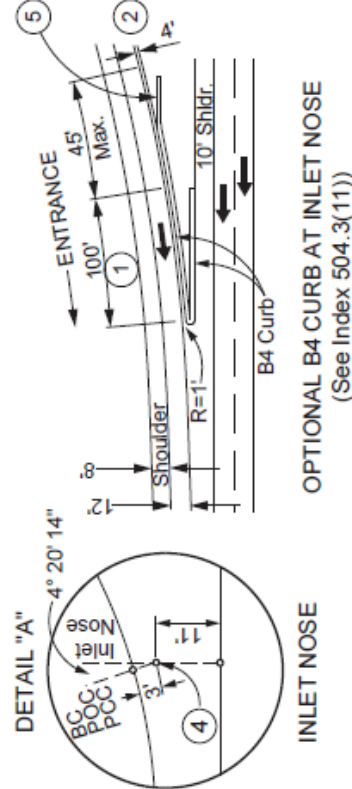
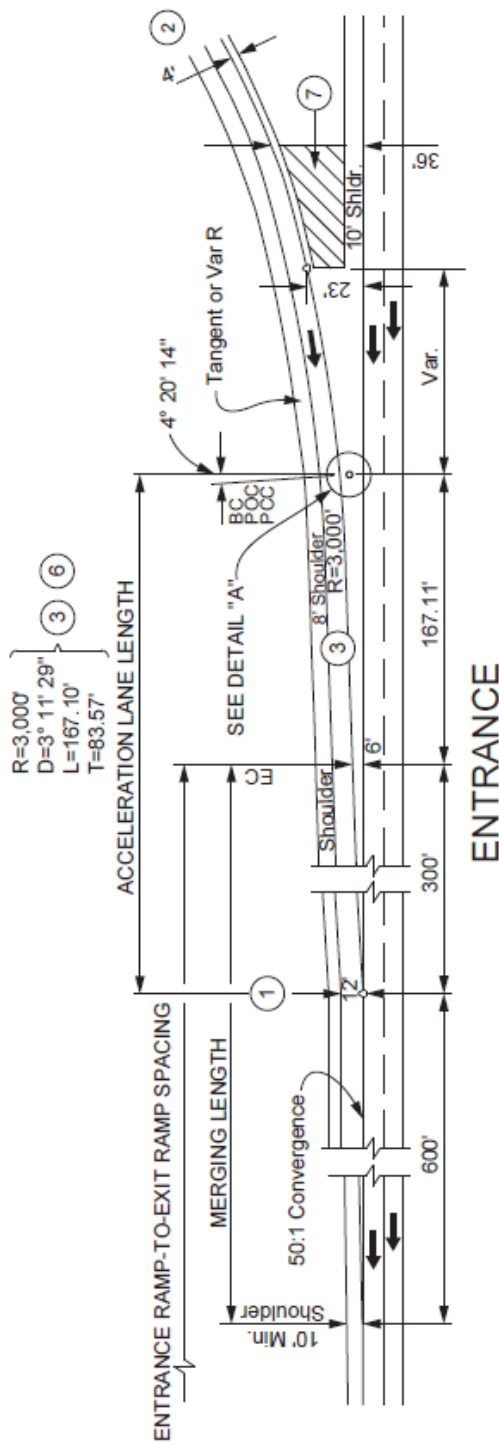

NOTES:

- 1 On freeway to freeway connections the right paved shoulder shall be 10' - Table 302.1.
- 2 On single- and two-lane freeway to freeway connections, the left paved shoulder shall be 5' - Table 302.1.
- 3 When freeway is not on tangent alignment, select radius to approximate same degree of convergence (see Index 504.2(3)).
- 4 Locate as if it were to be center of a 1' radius curb nose.
- 5 1:15 (longitudinal to lateral) Flare, 45' long - Table 405.4.
- 6 2% super-elevation may be acceptable for the 3,000' radius curve on entrance ramps.
- 7 Contrasting surface treatment (See Index 504.2(2)).
- 8 See Index 504.2(7) for pedestrian and bicycle ramp crossings on freeways where bicycle or pedestrian travel is not prohibited. See Index 302.1 for shoulder width standards.

July 1, 2020

Figure 504.2B

Single Lane Freeway Exit

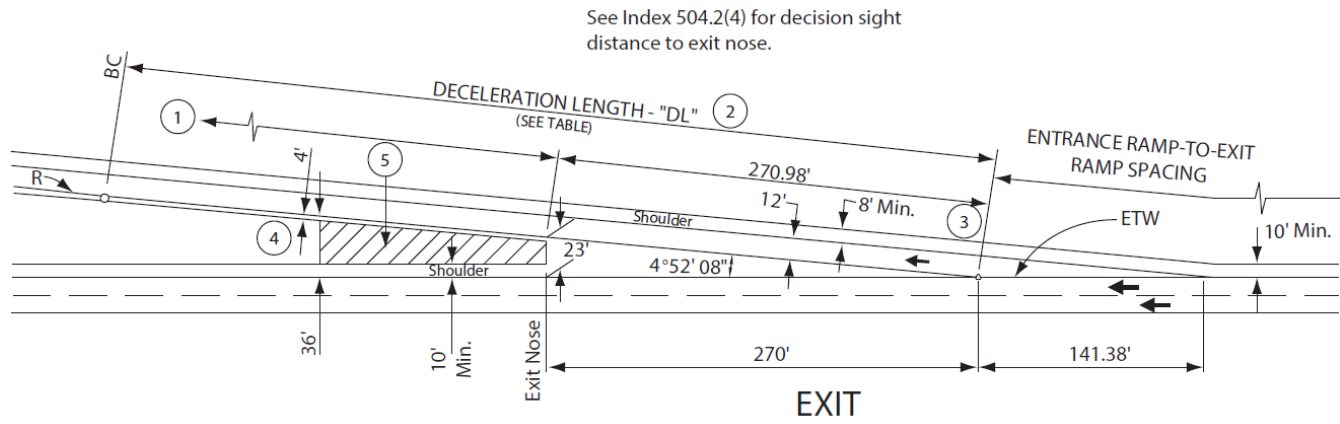

R (ft)	Min. DL (ft) ②
Less than 300	570
300 - 499	470
500 - 999	420
1,000 & over	270

- NOTES:
- ① Minimum length between exit nose and end of ramp is 525' for full stop at end of ramp.
 - ② "DL" distance should be lengthened for descending, short radius curves, or if entered from a sustained downgrade.
 - ③ On freeway to freeway connections the right paved shoulder shall be 10'. - Table 302.1
 - ④ On single- and two-lane freeway to freeway connections the left paved shoulder shall be 5'. - Table 302.1
 - ⑤ Contrasting surface treatment (See Index 504.2(2))
See Index 302.1 for shoulder width standards.

Figure 504.2C

Location of Freeway Ramps on a Curve

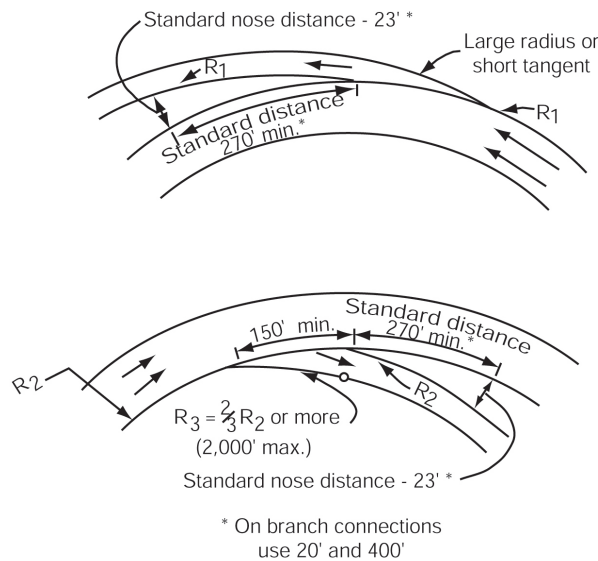

Decision sight distance given in Table 201.7 should be provided at freeway exits and branch connectors. At secondary exits on collector-distributor roads, a minimum of 600 feet of decision sight distance should be provided. In all cases, sight distance is measured to the center of ramp lane right of the nose.

- (b) Freeway Entrance—The design speed at the inlet nose should be consistent with approach alignment standards. If the approach is a branch connection or diamond ramp with high alignment standards, the design speed should be at least 50 miles per hour.
- (c) Ramps—See Index 504.3(1)(a).
- (d) Freeway-to-Freeway Connections—See Index 504.4(2).
- (5) Grades. Grades for freeway entrances and exits are controlled primarily by the requirements of sight distance. Ramp profile grades should not exceed 8 percent with the exception of descending entrance ramps and ascending exit ramps, where a 1 percent steeper grade is allowed. However, the 1 percent steeper grade should be avoided on descending loops to minimize overdriving of the ramp (see Index 504.3 (8)).

Profile grade considerations are of particular concern through entrance and exit gore areas. In some instances the profile of the ramp or connector, or a combination of profile and cross slope, is sufficiently different than that of the freeway through lanes that grade breaks across the gore may become necessary. Where adjacent lanes or lanes and paved gore areas at freeway entrances and exits are not in the same plane, the algebraic difference in pavement cross slope should not exceed 5 percent (see Index 301.3). The paved gore area is typically that area between the diverging or converging edge of traveled ways and the 23-foot point.

In addition to the effects of terrain, grade lines are also controlled by structure clearances (see Indexes 204.6 and 309.2). Grade lines for overcrossing and undercrossing roadways should conform to the requirements of HDM Topic 104 Roads Under Other Jurisdictions.

- (a) Freeway Exits—Vertical curves located just beyond the exit nose should be designed with a minimum 50 miles per hour stopping sight distance. Beyond this point,

July 1, 2020

progressively lower design speeds may be used to accommodate loop ramps and other geometric features.

Ascending off-ramps should join the crossroads on a reasonably flat grade to expedite truck starts from a stopped condition. If the ramp ends in a crest vertical curve, the last 50 feet of the ramp should be on a 5 percent grade or less. There may be cases where a drainage feature is necessary to prevent crossroads water from draining onto the ramp.

On descending off-ramps, the sag vertical curve at the ramp terminal should be a minimum of 100 feet in length.

- (b) Freeway Entrances. Entrance profiles should approximately parallel the profile of the freeway for at least 100 feet prior to the inlet nose to provide intervisibility in merging situations. The vertical curve at the inlet nose should be consistent with approach alignment standards.

Where truck volumes (three-axle or more) exceed 20 vehicles per hour on ascending entrance ramps to freeways and expressways with sustained upgrades exceeding 2 percent, a 1,500-foot length of auxiliary lane should be provided in order to ensure satisfactory operating conditions. Additional length may be warranted based on the thorough analysis of the site specific grades, traffic volumes, and calculated speeds; and after consultation with the District Traffic Safety Engineer or designee and the Project Delivery Coordinator or District Design Liaison. Also, see Index 204.5 "Sustained Grades".

(6) *Bus Stops.* See Index 108.2 and 303.4 for general information.

(7) *Bicycle and Pedestrian Conditions.* On freeways where bicycle or pedestrian travel is not prohibited, provisions need to be made at interchanges to accommodate bicyclists and pedestrians. See Topic 116 and the California MUTCD for additional guidance.

504.3 Ramps

(1) *General.*

- (a) Design Speed. When ramps terminate at an intersection at which all traffic is expected to make a turning movement, the minimum design speed along the ramp should be 25 miles per hour. When a "through" movement is provided at the ramp terminus, the minimum ramp design speed should meet or exceed the design speed of the highway facility for which the through movement is provided. The design speed along the ramp will vary depending on alignment and controls at each end of the ramp. An acceptable approach is to set design speeds of 25 miles per hour and 50 miles per hour at the ramp terminus and exit nose, respectively, the appropriate design speed for any intermediate point on the ramp is then based on its location relative to those two points. When short radius curves with relatively lower design speeds are used, the vertical sight distance should be consistent with approach vehicle speeds. See Index 504.2(4) for additional information regarding design speed for ramps.
- (b) Lane Width. **Ramp lanes shall be a minimum of 12 feet in width. Where ramps have curve radii of 350 feet or less, measured along the outside edge of traveled way for single lane ramps or along the outside lane line for multilane ramps, with a central angle greater than 60 degrees, the single ramp lane, or the lane furthest to the right if the ramp is multilane, shall be widened in accordance with Table 504.3 in order to accommodate large truck wheel paths.** See Topic 404. Consideration may be given to widening more than one lane on a multilane ramp with short radius curves if there is a likelihood of considerable transit or truck usage of that lane.

Table 504.3

Ramp Widening for Trucks

Ramp Radius (ft)	Widening (ft)	Lane Width (ft)
<150	8	20
150 – 179	5	17
180 – 209	4	16
210 – 249	3	15
250 – 299	2	14
-300 – 350	1	13
>350	0	12

(c) Shoulder Width. **Shoulder widths for ramps shall be as indicated in Table 302.1.** Typical ramp shoulder widths are 4 feet on the left and 8 feet on the right.

(d) Lane Drops. Typically, lane drops are to be accomplished over a distance equal to WV. Where ramps are metered, the recommended lane drop taper past the meter limit line is 50 to 1 (longitudinal to lateral). Depending on approach geometry and speed, the lane drop transition between the limit line and the 6-foot separation point should be accomplished with a taper of between 30:1 and 50:1 (longitudinal to lateral). This is further explained in Index 504.3(2)(b) for metered multilane entrance ramps. **However, the lane drop taper past the limit line shall not be less than 15 to 1.**

Lane drop tapers should not extend beyond the 6-foot point without the provision of an auxiliary lane.

(e) Lane Additions Lane additions to ramps are usually accomplished by use of a 120-foot bay taper. See Table 405.2A for the geometrics of bay tapers.

(2) Ramp Metering.

Caltrans Deputy Directive (DD) No. 35-R1, Ramp Metering, contains the statewide policy for ramp metering which delegates responsibility for its implementation in part through the Ramp Metering Design Manual (RMDM). DD 35-R1 specifies that provisions for entrance ramp metering shall be included in any project that proposes additional capacity, modification of an existing interchange, or construction of a new interchange, within the freeway corridors identified in the Ramp Metering Development Plan (RMDP), regardless of funding source. Projects designed for new or existing freeway segments experiencing recurring traffic congestion and/or a high frequency of vehicle collisions may include provisions for entrance ramp metering, whether or not the freeway segment locations are listed in the RMDP.

All geometric designs for ramp metering installations must be discussed with the Project Delivery Coordinator or District Design Liaison. Design features or elements which deviate from design standards require the approvals described in Index 82.2.

See the RMDM for ramp metering guidance, procedures, and policies to be used in conjunction with the guidance in this manual. Where traffic-related ramp metering guidance is noted in this Chapter, reference is made to the RMDM for exception instructions and further information. The number of lanes at the limit line denotes a metered single or multilane entrance ramp configuration. Geometric ramp design for operational improvement

May 20, 2022

projects which include ramp metering should be based on current peak-hour traffic volume. If this current data is not available it should be obtained before proceeding with design. Peak hour traffic data from the annual Caltrans Traffic Volumes book is not adequate for this application.

The design advice and typical designs that follow should not be directly applied to ramp meter installation projects, especially retrofit designs. Every effort should be made by the designer to exceed the recommended minimum standards provided herein, where conditions are not restrictive.

(a) Metered Freeway Entrance Ramps (1 General Purpose (GP) or 1 GP + 1 HOV Preferential Lane).

According to the RMDM, a High-Occupancy Vehicle (HOV) preferential lane shall be provided where ramp meters are installed, and each HOV preferential lane should be metered. See the RMDM for exception procedures from the Ramp Metering policy. See Figures 504.3A and 504.3B for typical freeway entrance ramp metering (1 GP Lane + 1 HOV Preferential Lane).

Due to the operational benefits of an auxiliary lane, metered single or multilane freeway entrance ramps should include an auxiliary lane with a minimum length of 300 feet downstream of the gore point. See Figures 504.3A and 504.3C.

Where truck (3 or more axles) volume is 5 percent or greater on ascending metered single or multilane freeway entrance ramps and connectors with sustained upgrades exceeding 3 percent at least throughout the merge area, a minimum 1,000-foot length of auxiliary lane should be provided downstream of the gore point

When vehicle volume exceeds 1500 vph, a 1,000 - foot minimum length of auxiliary lane should be provided downstream of the gore point for metered single or multilane freeway entrance ramps and connectors. If an auxiliary lane is present, the lane drop transition zone may extend to the gore point. However, the proximity of the nearest interchange may warrant weaving analysis to determine the acceptability of extending the ramp lane transition beyond the 6-foot separation point. A longer auxiliary lane should be considered where mainline/ramp gradients and truck volumes warrant additional length.

(b) HOV Preferential Lane.

Ramp meter installations should operate in conjunction with, and complement, other transportation management system elements and transportation modes. As such, ramp meter installations should include preferential treatment of carpools and transit riders. Specific treatment(s) must be tailored to the unique conditions at each ramp location.

Where restrictive conditions, vehicle volumes less than 500 vehicles per hour (vph), or other engineering judgement exist in support of an exception to the HOV preferential lane, see Figures 504.3C and 504.3D. Where truck (3 or more axles) volumes are 5 percent or greater on ascending metered single-lane freeway entrance ramps and connectors with sustained upgrades exceeding 3 percent at least throughout the merge area, a minimum 500-foot length of auxiliary lane should be provided downstream of the gore point.

Figure 504.3A

Typical Freeway Entrance Loop Ramp Metering (1 GP Lane + 1 HOV Preferential Lane)

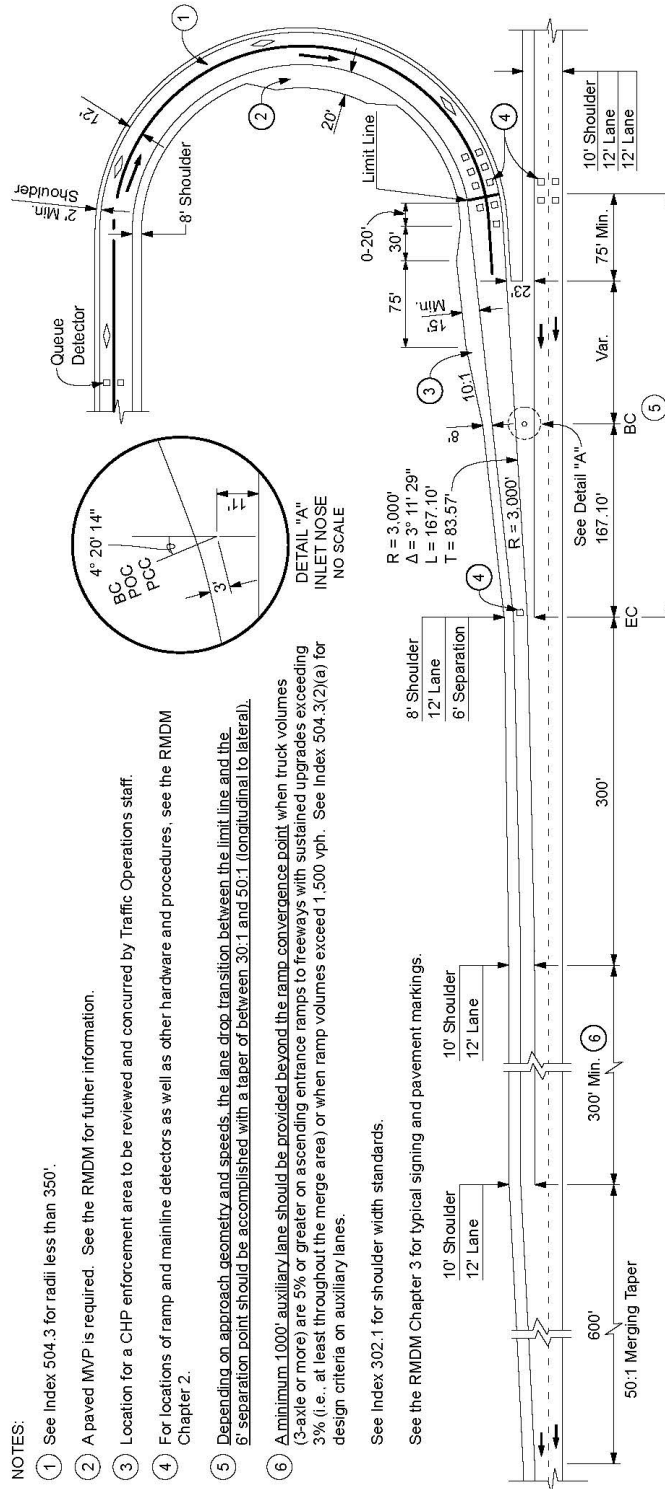

NOTES:

- ① See Index 504.3 for radii less than 350'.
- ② A paved MVP is required. See the RMDM for further information.
- ③ Location for a CHP enforcement area to be reviewed and concurred by Traffic Operations staff.
- ④ For locations of ramp and mainline detectors as well as other hardware and procedures, see the RMDM Chapter 2.
- ⑤ Depending on approach geometry and speeds, the lane drop transition between the limit line and the 6' separation point should be accomplished with a taper of between 30:1 and 50:1 (longitudinal to lateral).
- ⑥ A minimum 1,000' auxiliary lane should be provided beyond the ramp convergence point when truck volumes (3-axle or more) are 5% or greater on ascending entrance ramps to freeways with sustained upgrades exceeding 3% (i.e., at least throughout the merge area) or when ramp volumes exceed 1,500 vph. See Index 504.3(2)(a) for design criteria on auxiliary lanes.

See Index 302.1 for shoulder width standards.

See the RMDM Chapter 3 for typical signing and pavement markings.

May 20, 2022

Figure 504.3B

Typical Successive Freeway Entrance Ramp Metering (1 GP Lane + 1 HOV Preferential Lane)

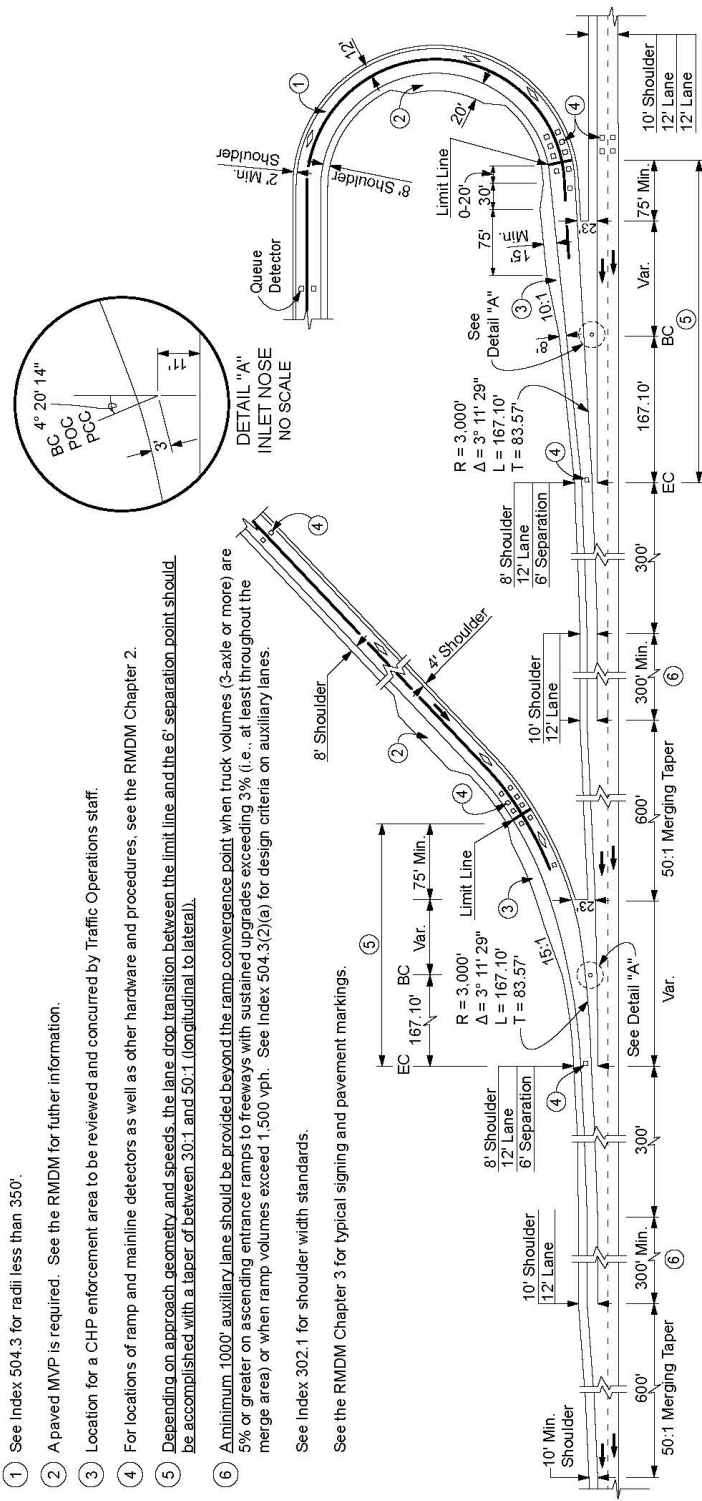

NOTES:

- ① See Index 504.3 for radii less than 350'.
- ② A paved MVP is required. See the RMDM for further information.
- ③ Location for a CHP enforcement area to be reviewed and concurred by Traffic Operations staff.
- ④ For locations of ramp and mainline detectors as well as other hardware and procedures, see the RMDM Chapter 2.
- ⑤ Depending on approach geometry and speeds, the lane drop transition between the limit line and the 6' separation point should be accomplished with a taper of between 30:1 and 50:1 (longitudinal to lateral).
- ⑥ A minimum 1000' auxiliary lane should be provided beyond the ramp convergence point when truck volumes (3-axle or more) are 5% or greater on ascending entrance ramps to freeways with sustained upgrades exceeding 3% (i.e., at least throughout the merge area) or when ramp volumes exceed 1,500 vph. See Index 504.3(2)(a) for design criteria on auxiliary lanes.

See Index 302.1 for shoulder width standards.

See the RMDM Chapter 3 for typical signing and pavement markings.

In general, the vehicle occupancy requirement for ramp meter HOV preferential lanes is typically two or more persons per vehicle. At some locations, a higher vehicle occupancy requirement may be necessary. The occupancy requirement should be based on the HOV demand and should match with other HOV facilities in the vicinity.

A HOV preferential lane should typically be placed on the left; however, demand and operational characteristics at the ramp entrance may dictate otherwise. Design of the HOV preferential lane at a metered entrance ramp requires the review and concurrence of the Caltrans District Traffic Operations Branch responsible for ramp metering.

Access to the HOV preferential lane may be provided in a variety of ways depending on interchange type and available storage length for queued vehicles. Where queued vehicles in the general purpose (GP) lane may block access to the HOV preferential lane, consider providing direct or separate access. To avoid trapping GP traffic in an HOV preferential lane, the signing and pavement marking at the ramp entrance should direct motorists into the GP lane(s). See the RMDM, Chapter 3 for signing and pavement markings. Designs should consider pedestrian/bicycle volumes, especially when the entrance ramp is located near a school or the local highway facility includes a designated bicycle lane or route. See Index 403.6 for right-turn-only lane guidance where bicycle travel is permitted. Contact the District Traffic Safety Engineer or designee and the Project Delivery Coordinator or District Design Liaison to discuss the application of specific design and/or general issues related to the design of HOV preferential lane access.

Signing for a HOV preferential lane should be placed to clearly indicate which lane is designated for HOVs. Real-time signing at the ramp entrance, such as an overhead changeable message sign, may be necessary at some locations if pavement delineation and normal signing do not provide drivers with adequate lane usage information. To avoid leading Single-Occupancy Vehicles (SOV) into a HOV preferential lane, pavement delineation at the ramp entrance should lead drivers into the SOV lane.

(c) Metered Multilane Freeway Entrance Ramps (2 GP + 1 HOV Preferential Lane).

The number of metered lanes at an entrance ramp is the number of both metered general purpose (GP) and high-occupancy vehicle (HOV) preferential lanes at the limit line. The minimum number of metered GP lanes is determined based on GP traffic demand. The number of metered HOV preferential lanes is determined based on HOV demand using the same guidelines as GP traffic demand, as well as the HOV preferential lane policy.

A multilane ramp segment may be provided to increase vehicle storage within the available ramp length. At on-ramps with peak hour volume between 500 and 900, a two-lane ramp meter may be provided to double the vehicles stored within the available storage area. See RMDM for additional multilane freeway entrance ramp guidance.

Figures 504.3E and 504.3F illustrate typical designs for metered multilane diagonal and loop freeway entrance ramps. On multilane loop ramps, typically only the right lane needs to be widened to accommodate design vehicle off-tracking. See Index 504.3(1)(b).

Three-lane metered ramps are typically needed to serve peak (i.e., commute) hour traffic along urban and suburban freeway corridors. The adverse effects of bus and truck traffic on the operation of these ramps (i.e., off-tracking, sight restriction, acceleration characteristics on upgrades, etc.) is minimized when the ramp alignment is tangential or consists of curve radii not less 300 feet. Proposed three-lane loop and four-lane entrance ramps require the review and approval by the Deputy District Director of Traffic Operations.

July 1, 2020

Figure 504.3C

Restrictive Condition Freeway Entrance Ramp Metering (1 GP Lane)

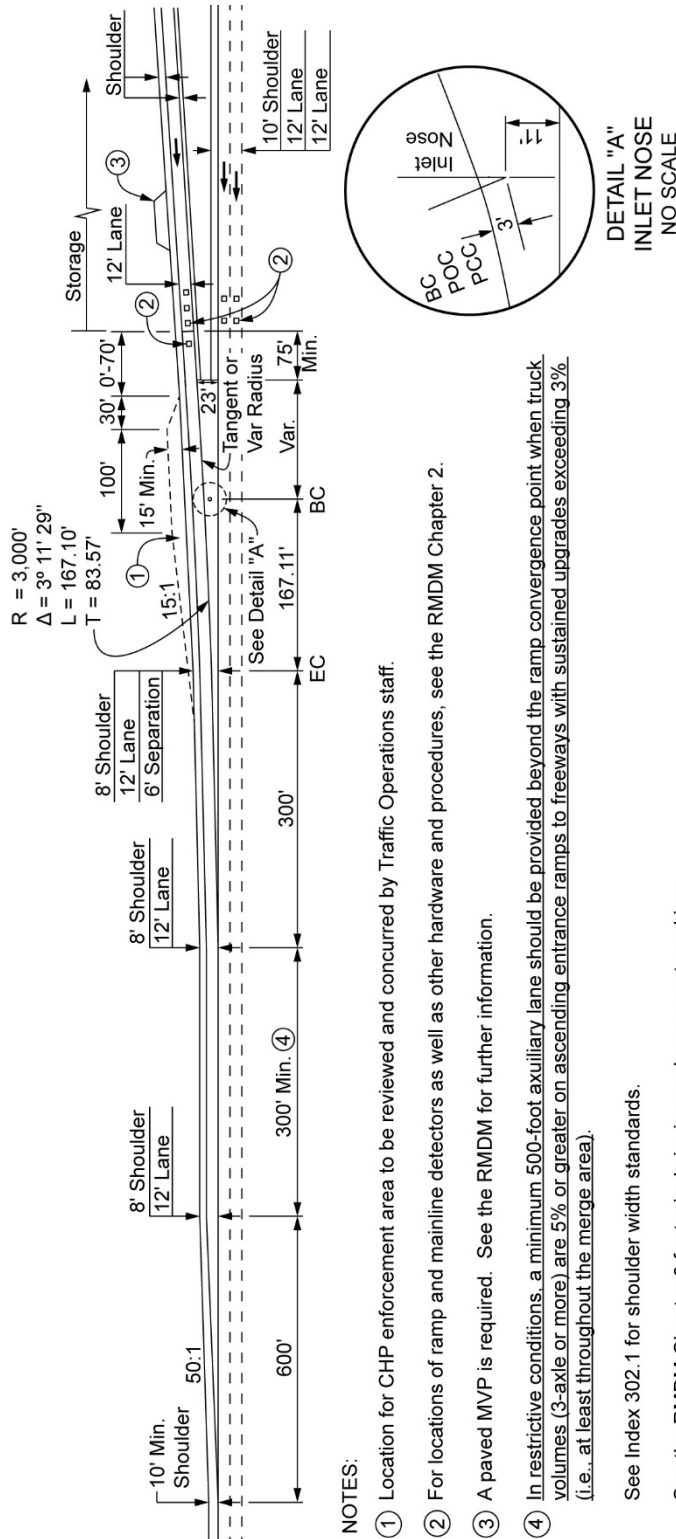
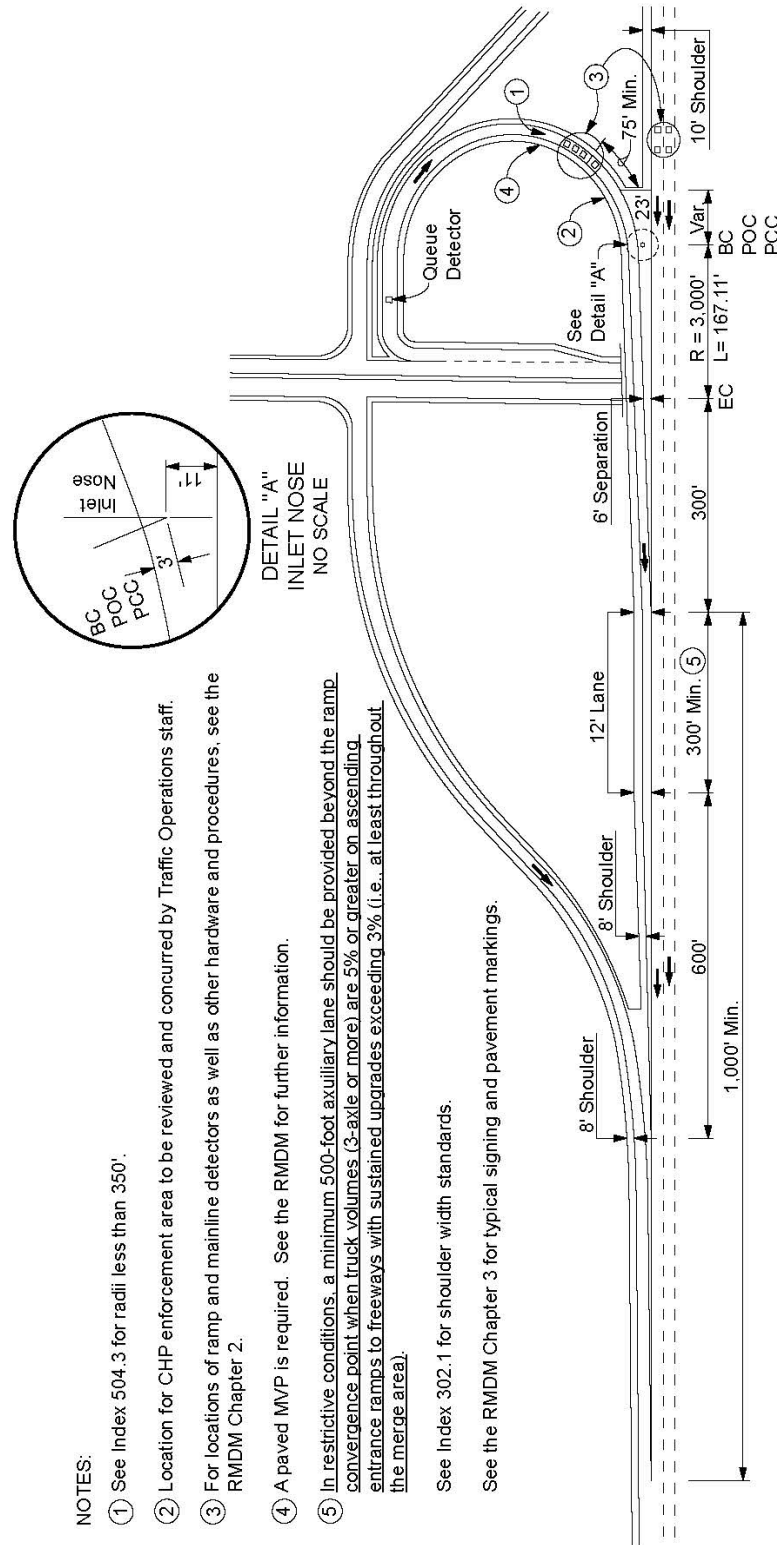

Figure 504.3D

Restrictive Condition Freeway Entrance Loop Ramp Metering (1 GP Lane)



NOTES:

- ① See Index 504.3 for radii less than 350'.
- ② Location for CHP enforcement area to be reviewed and concurred by Traffic Operations staff.
- ③ For locations of ramp and mainline detectors as well as other hardware and procedures, see the RMDM Chapter 2.
- ④ A paved MVP is required. See the RMDM for further information.
- ⑤ In restrictive conditions, a minimum 500-foot auxiliary lane should be provided beyond the ramp convergence point when truck volumes (3-axle or more) are 5% or greater on ascending entrance ramps to freeways with sustained upgrades exceeding 3% (i.e., at least throughout the merge area).

See Index 302.1 for shoulder width standards.

See the RMDM Chapter 3 for typical signing and pavement markings.

May 20, 2022

The multilane segment of metered freeway entrance ramps and connectors should transition to a single lane width between the meter limit line and the 6-foot separation point.

The lane drop transition should be accomplished with a taper of 50:1 (longitudinal to lateral) unless a lesser taper is warranted by site and/or project specific conditions which control the ramp geometry and/or anticipated maximum speed of ramp traffic. For example, "loop" entrance ramps would normally not allow traffic to attain speeds which would warrant a 50:1 (longitudinal to lateral) lane drop taper. Also, in retrofit situations, existing physical, environmental or right of way constraints may make it impractical to provide a 50:1 taper, especially if the maximum anticipated approach speed will be less than 50 miles per hour. Depending on approach geometry and speed, (See Index 206.3 for how to match the vehicle speed to lane-drop taper ratio) the lane drop transition zone between the meter limit line and the 6-foot separation point of metered multilane freeway entrance ramps should be accomplished with a taper ratio of between 50:1 and 30:1 (longitudinal traveled way length to transverse lane width). **However, the lane drop taper ratio past the meter limit line for metered freeway multilane entrance ramps shall not be less than 15:1 (longitudinal traveled-way length to transverse lane width).**

The merge from the metered entrance ramp to the freeway should include a 300-foot minimum auxiliary lane beyond the ramp convergence point.

Where truck volumes (3-axle or more) are 5 percent or greater on ascending entrance ramps to freeways with sustained upgrades exceeding 3 percent (i.e. at least throughout the merge area), a minimum 1,000 feet length of auxiliary lane should be provided beyond the ramp convergence point. AASHTO, A Policy on Geometric Design of Highways and Streets, provides additional guidance on acceleration lane length on grades.

When ramp volumes exceed 1,500 vph, a 1,000-foot minimum length of auxiliary lane should be provided beyond the ramp convergence point. If an auxiliary lane is included, the ramp lane transition may be extended to the convergence point. However, the proximity of the nearest interchange may warrant weaving analysis to determine the acceptability of extending the ramp lane transition beyond the 6-foot separation point. A longer auxiliary lane should be considered where mainline/ramp gradients and truck volumes warrant additional length.

(d) Metered Freeway-to-Freeway Connectors.

Freeway-to-freeway connectors may also be metered. The need to meter a freeway-to-freeway connector should be determined on an individual basis. Because connector ramps provide a link between two high speed facilities, drivers do not expect to stop, nor do they expect to approach a stopped vehicle.

The installation of metering on connectors shall be limited to those facilities that meet or exceed the following geometric design criteria:

- **Standard connector lane and shoulder widths.**
- **"Taillight" sight distance, measured from a 3 ½-foot eye height to a 2-foot object height, is provided for a minimum design speed of 50 miles per hour.**

All lane drops on connectors should be accomplished over a distance not less than WV. **All lane drop transitions on connectors shall be accomplished with a taper of 50:1 (longitudinal traveled-way length to transverse lane width) minimum,** (see Figures 504.3G and 504.3H). See RMDM Section 1.11 for additional guidance.

Figure 504.3E

Typical Multilane Freeway Diagonal Entrance Ramp Metering (2 GP Lanes + 1 HOV Preferential Lane)

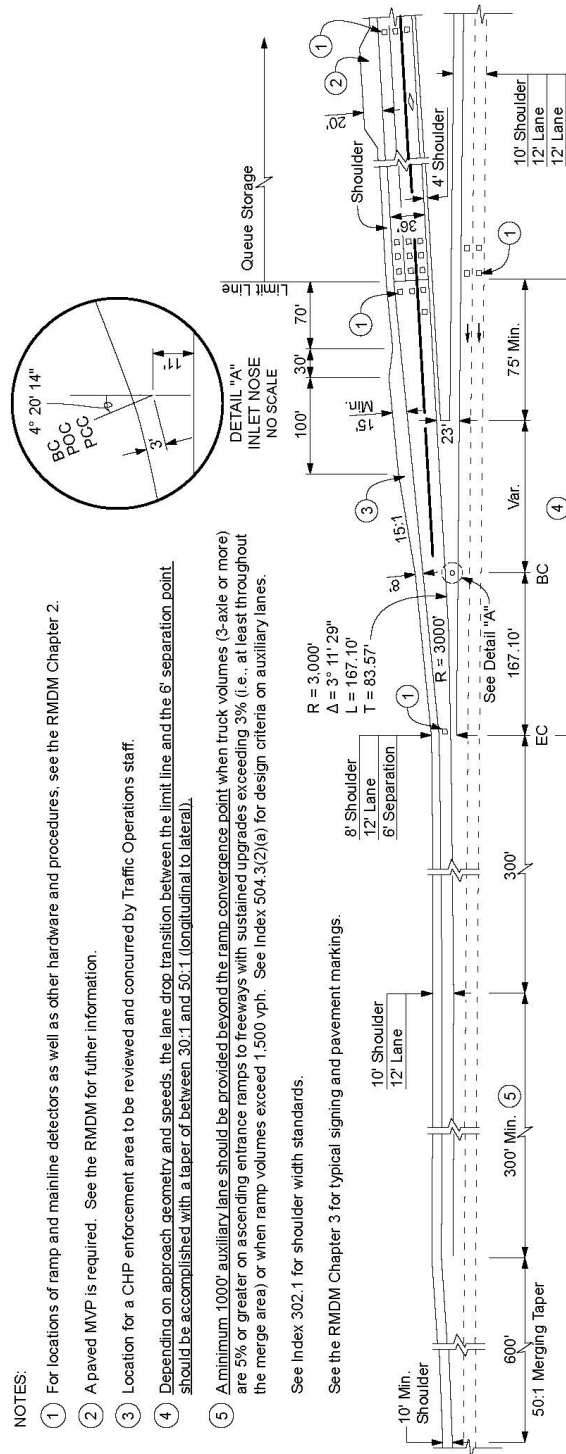

NOTES:

- ① For locations of ramp and mainline detectors as well as other hardware and procedures, see the RMDM Chapter 2.
- ② A paved MVP is required. See the RMDM for further information.
- ③ Location for a CHP enforcement area to be reviewed and concurred by Traffic Operations staff.
- ④ Depending on approach geometry and speeds, the lane drop transition between the limit line and the 6' separation point should be accomplished with a taper of between 30:1 and 50:1 (longitudinal to lateral).
- ⑤ A minimum 1000' auxiliary lane should be provided beyond the ramp convergence point when truck volumes (3-axle or more) are 5% or greater on ascending entrance ramps to freeways with sustained upgrades exceeding 3% (i.e., at least throughout the merge area) or when ramp volumes exceed 1,500 vph. See Index 504.3(2)(a) for design criteria on auxiliary lanes.

May 20, 2022

Figure 504.3F

Typical Multilane Freeway Loop Entrance Ramp Metering (2 GP Lanes + 1 HOV Preferential Lane)

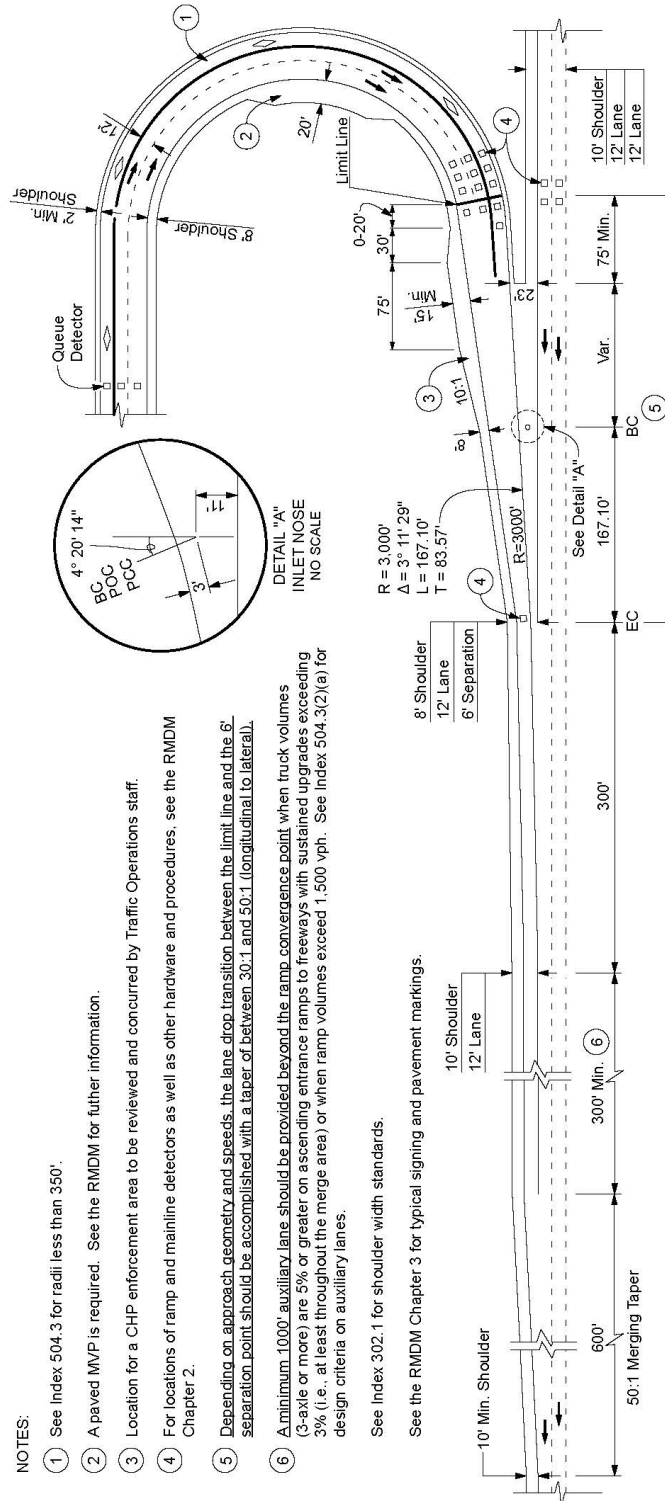

NOTES:

- 1 See Index 504.3 for radii less than 350'.
- 2 A paved MVP is required. See the RMDM for further information.
- 3 Location for a CHP enforcement area to be reviewed and concurred by Traffic Operations staff.
- 4 For locations of ramp and mainline detectors as well as other hardware and procedures, see the RMDM Chapter 2.
- 5 Depending on approach geometry and speeds, the lane drop transition between the limit line and the 6' separation point should be accomplished with a taper of between 30:1 and 50:1 (longitudinal to lateral).
- 6 A minimum 1000' auxiliary lane should be provided beyond the ramp convergence point when truck volumes (3-axis or more) are 5% or greater on ascending entrance ramps to freeways with sustained upgrades exceeding 3% (i.e., at least throughout the merge area) or when ramp volumes exceed 1,500 vph. See Index 504.3(2)(a) for design criteria on auxiliary lanes.

See Index 302.1 for shoulder width standards.

See the RMDM Chapter 3 for typical signing and pavement markings.

(e) Queue Storage Length

In order to maximize the effectiveness of operational strategies, an important design consideration for a ramp meter system is providing adequate storage for queues. Storage length design requires the review and concurrence of the Caltrans District Traffic Operations Branch responsible for ramp metering. See RMDM Section 1.4 for detailed queue storage length design guidance.

To minimize the impact on local street operation, every effort should be made to meet the recommended storage length. Wherever feasible, ramp metering storage should be contained on the ramp by either widening or lengthening it. Improvements to the local street system in the vicinity of the ramp should also be thoroughly investigated where there is insufficient storage length on the ramp and the ramp queue will adversely affect local street operation. Note that excessive queue length may also impact the mobility of pedestrians and bicyclists. The storage length that can be provided on the ramp may be limited by the weaving distance to the next off-ramp and/or available right of way. Local street improvements can include widening or restriping the street(s) or intersection(s) to provide additional storage or capacity. Signal timing revisions along the corridor feeding the ramp can also enhance the storage capability. These will require coordination with the local agency consistent with the regional traffic operations strategy.

It is the responsibility of the Department, on Department initiated projects, to mitigate the effect of ramp metering, for initial as well as future operational impacts, to local streets that lead to metered freeway entrance ramps. It is the responsibility of developers and/or local agencies, to mitigate any impact to existing ramp meter facilities, future ramp meter installations, or local streets, when those impacts are attributable to new development and/or local agency roadway improvement projects.

(f) Pavement Structure.

In planning for the possibility of future widening, the pavement structure for the ramp shoulders should be equal to the ramp traveled way pavement structure. In locations where failure of loop detectors due to flexible pavement deterioration is a concern, a Portland Cement Concrete (PCC) pad may be considered on new construction and rehabilitation projects. The concrete pad should cover the metering detector loop area upstream and downstream of the limit line.

(g) Meter Signal Location.

For the location of ramp meter signal standards, see the RMDM, Chapter 2.

(h) Limit Line Location.

The limit line location will be determined by the selected transition taper, but should be a minimum of 75 feet upstream of the 23-foot separation point. See the RMDM Section 1.7 for additional guidance.

(i) Modifications to Existing HOV Preferential Lanes.

Changes in traffic conditions, proposals for interchange modifications, recurrent operational problems affecting the local facility, or the need to further improve mainline operations through more restrictive metering are opportunities to reevaluate the need for a HOV preferential lane. Typically, an existing HOV preferential lane may be considered for conversion to a GP lane if the existing HOV preferential lane is underutilized, there is a need for additional queue storage for the GP lanes, or an alternate entrance ramp HOV preferential lane is available within 1½ miles. See the RMDM for procedures when

July 1, 2020

Figure 504.3G

Typical Freeway-to-Freeway Connector Ramp Metering (1 GP Lane + 1 HOV Preferential Lane)

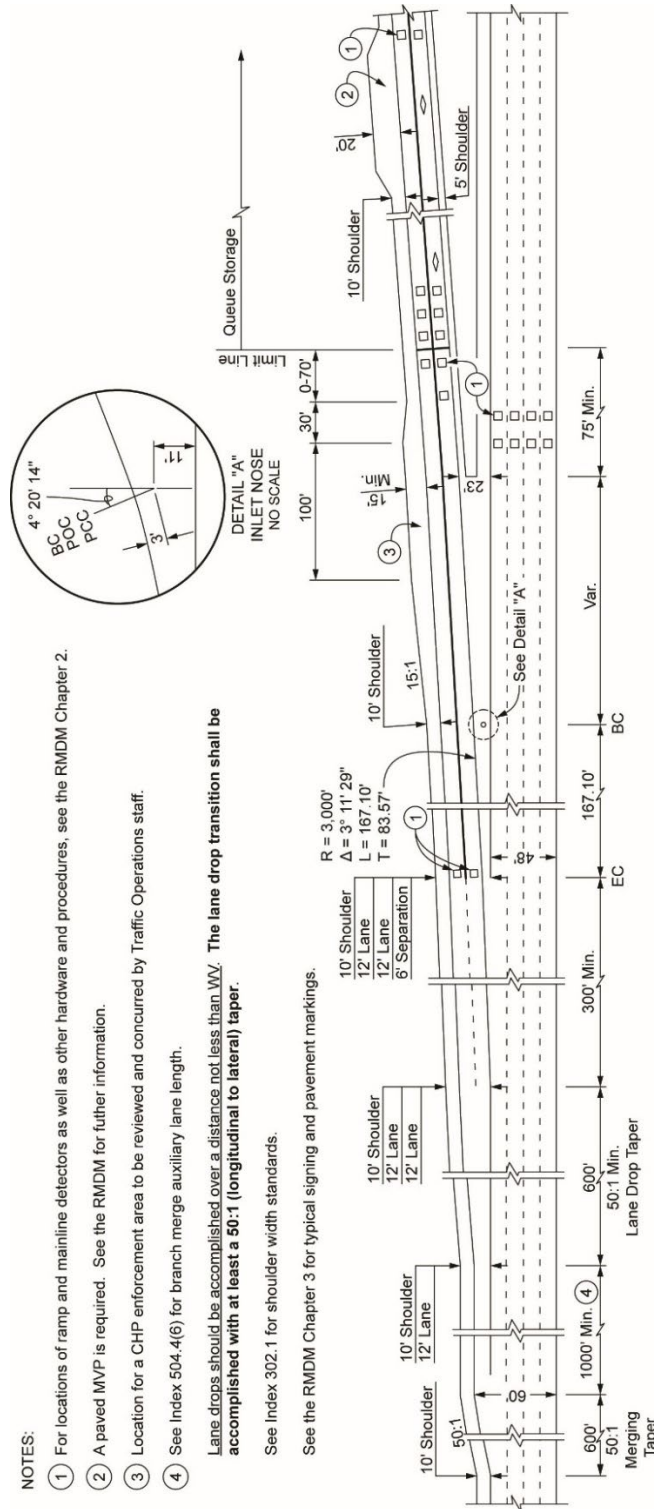

NOTES:

- ① For locations of ramp and mainline detectors as well as other hardware and procedures, see the RMDM Chapter 2.
- ② A paved MVP is required. See the RMDM for further information.
- ③ Location for a CHP enforcement area to be reviewed and concurred by Traffic Operations staff.
- ④ See Index 504.4(6) for branch merge auxiliary lane length.

Lane drops should be accomplished over a distance not less than WV . The lane drop transition shall be accomplished with at least a 50:1 (longitudinal to lateral) taper.

See Index 302.1 for shoulder width standards.

See the RMDM Chapter 3 for typical signing and pavement markings.

September 29, 2023

considering conversion of a HOV preferential lane to a GP lane at a metered entrance ramp.

(j) Enforcement Areas and Maintenance Pullouts.

Division of Traffic Operations policy requires a paved enforcement area to be provided on all projects that include new or reconstructed metered entrance ramps or connectors.

See the RMDM for exception procedures to this policy.

Enforcement areas are used by the California Highway Patrol (CHP) to enforce minimum vehicle occupancy requirements. The paved enforcement area should be placed on the right side of a metered entrance ramp, downstream of the metering signals, and as close to the limit line as practical to facilitate CHP enforcement. See Figures 504.3A to 504.3H for the typical layout and dimensions of enforcement areas.

The District Traffic Operations Branch responsible for ramp metering must coordinate enforcement issues with the CHP. The CHP Area Commander must be contacted during the development of the project report or PA & ED phase, prior to design, to discuss any variations needed to the CHP enforcement area designs shown in this manual. Variations to enforcement area dimensions or location require the review and concurrence of the CHP and the Caltrans District Traffic Operations Branch responsible for ramp metering.

Division of Traffic Operations policy requires a paved Maintenance Vehicle Pullout (MVP) to be provided at a location for maintenance and operations personnel to access controller cabinets. The MVP should be placed upstream or next to controller cabinets. The MVP and the controller cabinets should be placed on the same side of the entrance ramp. At loop entrance ramps, locate the MVP to the inside of the loop ramp. A paved walkway should be provided between the MVP and the controller cabinets. See RMDM Section 2.4 for controller cabinet placement. See Topic 309, Clearances, for placement guidance of fixed objects such as controller cabinets. See the RMDM for exception procedures to this policy.

(3) *Location and Design of Ramp Intersections on the Crossroads.*

Factors which influence the location of ramp intersections on the crossroads include sight distance, construction and right of way costs, bicycle and pedestrian mobility, circuitous travel for left-turn movements, crossroads gradient at ramp intersections, storage requirements for left-turn movements off the crossroads, and the proximity of other local road or bicycle path intersections.

Ramp intersections with local roads are intersections at grade. Chapter 400 and the references therein contain general guidance. For ramp intersections, a wrong-way movement onto an off-ramp can have severe consequences. The California MUTCD also contains guidance for signing and striping to deter wrong-way movements.

Interchange Types L-7, L-8, and L-9 are partial cloverleaf designs with ramps at a right angle to the crossroad where the off-ramps and on-ramps are adjacent to each other on the same side of the crossroad that offer benefits for non-motorized travel modes; however, additional design considerations as follows may be appropriate in order to deter wrong-way movements:

- The entrance and exit ramps should be clearly visible from the crossroad. Concrete barrier or guardrail placed between the ramps can block the view from the crossroad. If feasible, the concrete barrier or guardrail channelization feature should be set back from the crossroad edge of shoulder 20 to 50 feet with a raised traffic island placed from the

ramp termini to the begin point of the separation feature. See Index 405.4 for further traffic island guidance. Consult the District Traffic Safety Branch for available options.

- Vehicles turning left onto an on-ramp are to be prevented, to the maximum extent feasible, from turning prematurely onto the off-ramp by placing or extending a curbed median on the crossroad to physically discourage this move. Attention needs to be given to accommodating truck turn templates for design vehicles entering and exiting the freeway. See Index 404.5 for further turning template guidance. Truck aprons could be provided if the size of an intersections becomes too large for an occasional truck. See Index 405.10, Roundabouts, and the references therein for design guidance on truck aprons.

Isolated off-ramps are to be avoided to minimize the potential for wrong-way movements. If the isolated off-ramp is necessary, the leading curb return from the perspective of a vehicle on the crossroad approaching from the same side as the off-ramp is made with a short radius curve of 3 to 5 feet. State or local roads and driveways opposite isolated off-ramps are to be avoided as there is no corresponding on-ramp for cross traffic to take. See this chapter for further interchange and ramp guidance.

Ramp terminals should connect where the grade of the overcrossing is 4 percent or less to avoid potential overturning of trucks.

For left-turn maneuvers from an off-ramp at an unsignalized intersection, the length of crossroads open to view should be according to the corner sight distance criteria in Index 405.1.

When proposing uncontrolled entries and exits from freeway ramps with local roads, see the Design of Intersections at Interchanges guidance in Index 403.6(2).

Corner sight distance restrictions may be caused by bridge railings, bridge piers, or slopes. Corner sight distance is measured along the crossroad between the vehicle in the center of the outside lane of the crossroad approaching the ramp and the eye of the driver of the ramp vehicle that is set back from the edge of traveled way of the crossroad. Figure 504.31 illustrates the relationship of the ramp vehicle that is set back from an overcrossing structure, which is based on the sight distance controlled by the bridge rail location using the corner sight distance criteria. The same relationship exists for sight distance controlled by bridge piers or slopes.

Where the clear sight triangle is unobtainable according to Index 405.1, sight distance should be provided by flaring the end of the overcrossing structures or setting back the piers or end slopes of an undercrossing structure. The sight line should take into account if the bridge railing is see-through or is at a height below the driver's eye height. Note, the bridge railing may have added features, such as chain link railing, tubular hand railing, sound barrier, decorative architectural pedestals, etc.

If signals are warranted within 5 years of construction, consideration may be given to installing signals according to Part 4 of the California MUTCD, 4B.107(CA) and 4C.09.

For additional information on sight distance requirements at signalized intersections, see Index 405.1.

The minimum distance (curb return to curb return) between ramp intersections and local road intersections shall be 400 feet. The preferred minimum distance should be 500 feet. This does not apply to Resurfacing, Restoration and Rehabilitation (3R), ramp widening, restriping or other projects which do not reconfigure the interchange. This standard does apply to projects proposing to realign a local street.

Where intersections are closely spaced, traffic operations are often inhibited by short weave distance, storage lengths, and signal phasing. In addition it is difficult to provide proper

July 1, 2020

signing and delineation. The District Traffic Branch should be consulted regarding traffic engineering studies needed to determine the appropriate signage, delineation, and form of intersection control.

(4) *Superelevation for Ramps.*

The factors controlling superelevation rates discussed in Topic 202 apply also to ramps. As indicated in Index 202.2 use the 12 percent e_{max} rate except where snow and ice conditions prevail. In restrictive cases where the length of curve is too short to develop standard superelevation, the highest obtainable rate should be used (see Index 202.5). If feasible, the curve radius can be increased to reduce the standard superelevation rate. Both edge of traveled way and edge of shoulder should be examined at ramp junctions to assure a smooth transition.

Under certain restrictive conditions the standard superelevation rate discussed above may not be required on the curve nearest the ramp intersection of a ramp. The specific conditions under which lower superelevation rates would be considered must be evaluated on a case-by-case basis and must be discussed with the Project Delivery Coordinator or the District Design Liaison and then documented as required by the Project Delivery Coordinator.

(5) *Single-lane Ramps.*

Single lane ramps are those ramps that either enter into or exit from the freeway as a single lane. These ramps are often widened near the ramp intersection with the crossroads to accommodate turning movements onto or from the ramp. When additional lanes are provided near an entrance ramp intersection, the lane drop should be accomplished over a distance equal to WV . The lane to be dropped should be on the right so that traffic merges left.

Exit ramps in metropolitan areas may require multiple lanes at the intersection with the crossroads to provide additional storage and capacity. If the length of a single lane ramp exceeds 1,000 feet, an additional lane should be provided on the ramp to permit passing maneuvers. Figure 504.3J illustrates alternative ways of transitioning a single lane exit ramp to two lanes. The decision to use Alternate A or Alternate B is generally based on providing the additional lane for the minor movement.

(6) *Two-lane Exit Ramps.*

Where design year estimated volumes exceed 1500 equivalent passenger cars per hour, a 2-lane ramp should be provided. Provisions should be made for possible widening to three or more lanes at the crossroads intersection. Figure 504.3K illustrates the standard design for a 2-lane exit. An auxiliary lane approximately 1,300 feet long should be provided in advance of a 2-lane exit. For volumes less than 1500 but more than 900, a one-lane width exit ramp should be provided with provision for adding an auxiliary lane and an additional lane on the ramp.

(7) *Two-lane Entrance Ramps.* These ramps are discouraged in congested corridors. Early discussion with the Project Delivery Coordinator, District Design Liaison and the District Traffic Engineer or designee is recommended whenever two-lane entrance ramps are being considered.

(8) *Loop Ramps.* Normally, loop ramps should have one lane and shoulders unless a second lane is needed for capacity or ramp metering purposes. Consideration should be given to providing a directional ramp when loop volumes exceed 1500 vehicles per hour. If two lanes are provided, normally only the right lane needs to be widened for trucks. See Topic 404 for additional discussion on lane widths and design of ramp intersections to accommodate the design vehicle. See Index 504.3(1) for a discussion regarding on-ramp widening for trucks.

Figure 504.3I

Location of Ramp Intersections on the Crossroads

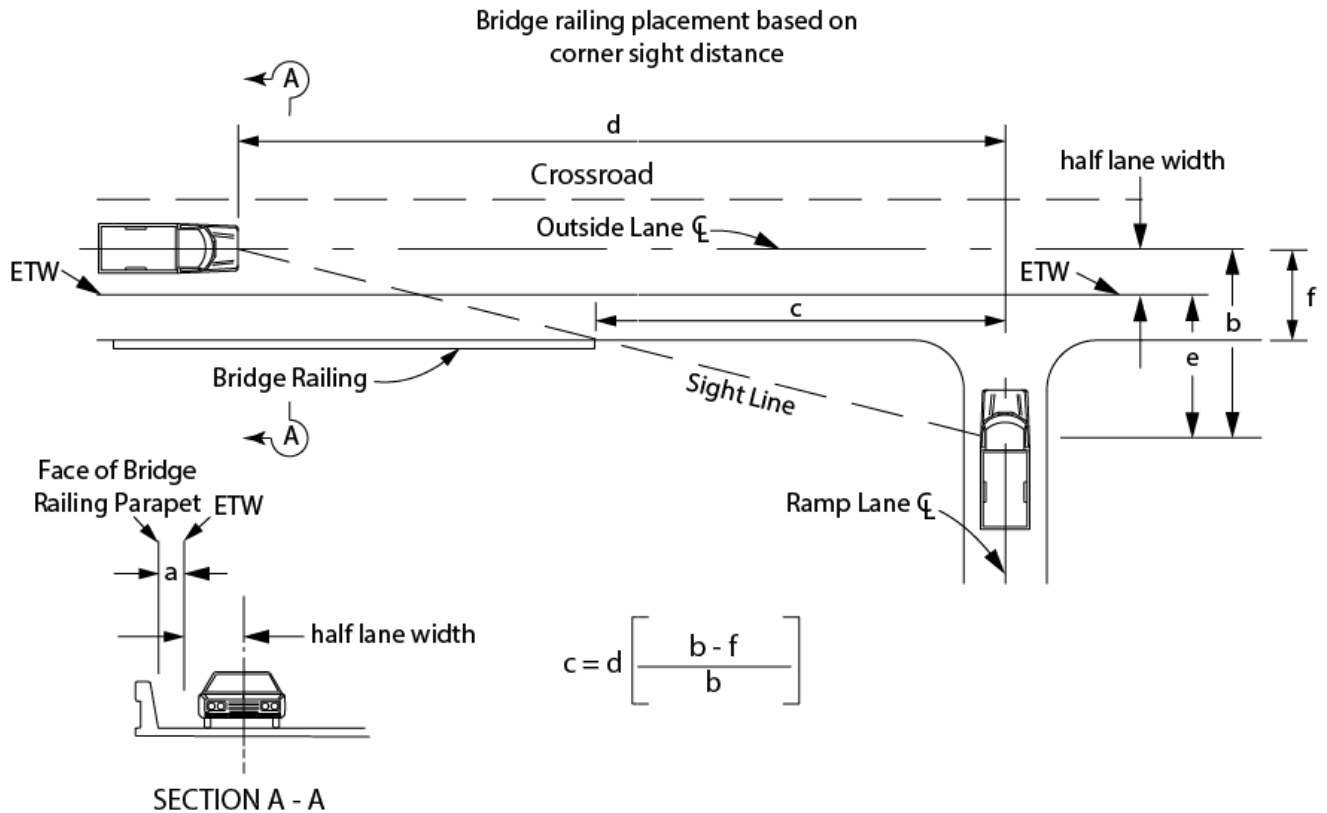

- a = Distance from edge of traveled way (ETW) to bridge railing; includes sidewalk width, if present.
- b = Distance from center of outside lane to assumed eye of ramp vehicle driver.
b = half lane width + e
- c = Ramp set back from end of bridge railing.
- d = Corner sight distance measured along the crossroad from the intersection. See Index 405.1.
- e = Driver's eye set back: Ramp driver's eye is assumed to be located 10' plus the shoulder width, but not less than 15' from the ETW. See Index 405.1.
- f = half lane width + a

July 1, 2020

Figure 504.3J

Transition to Two-lane Exit Ramp

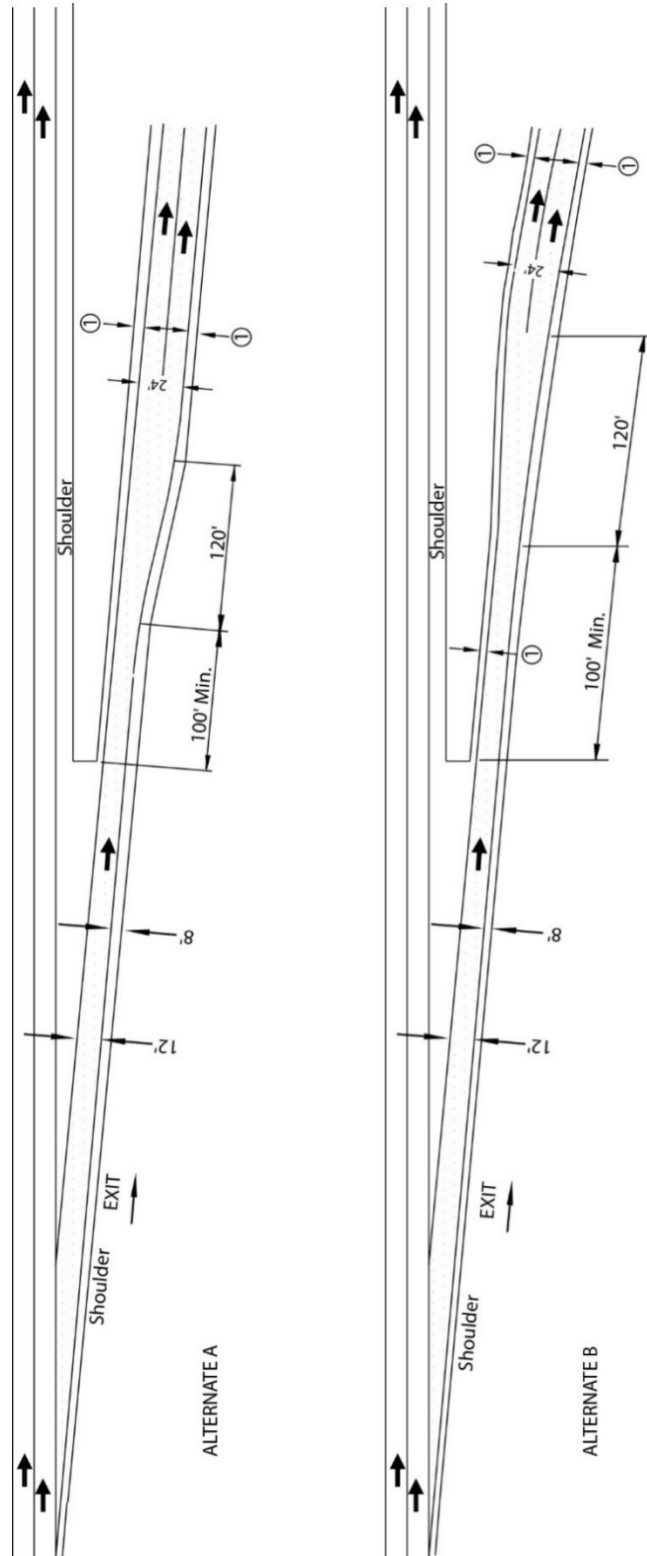

NOTES:

① See Index 302.1 for shoulder width standards. If shoulder reductions occur, see Index 206.3(4) for transitions.

Figure 504.3K

Two-Lane Connectors and Entrance/Exit Ramps

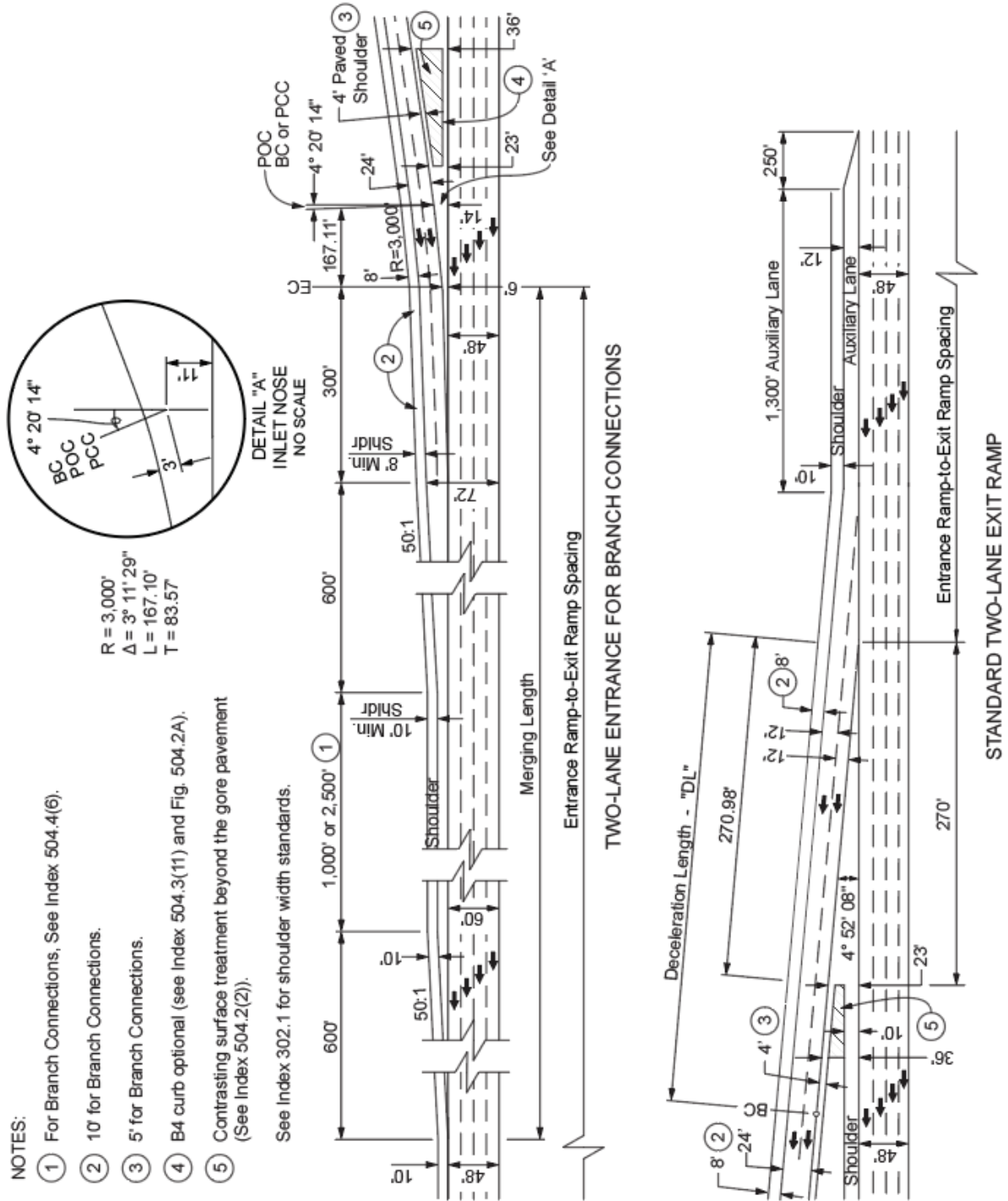

September 29, 2023

Radii for loop ramps should normally range from 150 feet to 200 feet. Increasing the radii beyond 200 feet is typically not cost effective as the slight increase in design speed is usually outweighed by the increased right of way requirements and the increased travel distance. Curve radii of less than 120 feet should also be avoided. Extremely tight curves lead to increased off-tracking by trucks and increase the potential for vehicles to enter the curve with excessive speed. Therefore, consider providing the ramp lane pavement structure on shoulders for curves with a radius less than 300 feet (see Indexes 626.1 and 636.1).

Of particular concern in the design of loop ramps are the constraints imposed on large trucks. Research indicates that trucks often enter loops with excessive speed, either due to inadequate deceleration on exit ramps or due to driver efforts to maintain speed on entrance ramps to facilitate acceleration and merging. Where the loop is of short radius and is also on a steep descent (over 6 percent), it is important to develop the standard 2/3 full superelevation rate by the beginning of the curve (see Index 504.2(5)). When accommodating design vehicles in Rural Transitional Corridors that are largely composed of industrial, commercial or retail buildings located separately from housing, the following considerations may be necessary to meet the standard 2/3 full superelevation rate on loop entrance ramps:

- Begin the ramp with a short tangent (75 feet to 100 feet) that diverges from the cross street at an angle of 4 to 9 degrees.
- Provide additional tangent length as site conditions allow.

The Angle of Intersection guidance in Index 403.3 applies to all on-ramps including loops.

(9) *Distance Between Successive On-ramps.* The minimum distance between two successive on-ramps to a freeway lane should be the distance needed to provide the standard on-ramp acceleration taper shown on Figure 504.2A. This distance should be about 1,000 feet unless the upstream ramp adds an auxiliary lane in which case the downstream ramp should merge with the auxiliary lane in a standard 50:1 (longitudinal to lateral) convergence. The distance between on-ramp noses will then be controlled by interchange geometry.

(10) *Distance Between Successive Exits.* The minimum distance between successive exit ramps for guide signing should be 1,000 feet on the freeway and 600 feet on collector-distributor roads.

(11) *Curbs.* Curbs should not be used on ramps except in the following locations:

- (a) A Type D curb or 4-inch Type B curb (see Index 303.2) may be used on both sides of the separation between freeway lanes and a parallel collector-distributor road.
- (b) A B4 curb may be used as shown in Figure 504.2A to control drainage or where the gore cross slope would be greater than allowed in Index 504.2(5). When the optional B4 curb is used at the entrance ramp inlet nose, the shoulder adjacent to the curb should be the same width as the ramp shoulder approaching the curb. The B4 gutter pan can be included as part of the shoulder width. As stated in Index 405.4(2), curbs are typically discouraged where posted speeds are over 40 miles per hour. Curbs at gore areas must be determined on a case-by-case basis.
- (c) Curbs may be used where necessary at the ramp connection with the local street for the protection of pedestrians, for channelization, and to provide compatibility with the local facility.
- (d) The Type E curb may be used only in special drainage situations, for example, where drainage parallels and flows against the face of a retaining wall.

In general, curbs should not be used on the high side of ramps or in off-ramp gore areas except at collector-distributor roads. The off-tracking of trucks should be analyzed when considering curbs on ramps.

(12) *Dikes*. Dikes may be used where necessary to control drainage. For additional information see Index 303.3.

504.4 Freeway-to-Freeway Connections

(1) *General*.

All of the design criteria discussed in Indexes 501.3, 504.2 and 504.3 apply to freeway to freeway connectors, except as discussed or modified below.

(2) *Design Speed*.

The design speed for single lane directional and all branch connections should be a minimum of 50 miles per hour. When smaller radius curves, with lower design speeds, are used the vertical sight distance should be consistent with approaching vehicle speeds. Design speed for loop connectors should be consistent with the radii guidance discussed in Index 504.3(8).

(3) *Grades*.

The maximum profile grade on freeway-to-freeway connections should not exceed 6 percent. Flatter grades and longer vertical curves than those used on ramps are needed to obtain increased stopping sight distance for higher design speeds.

(4) *Shoulder Width*.

(a) Single-lane and Two-lane Connections—**The width of shoulders on single-lane and two-lane (except as described below) freeway-to-freeway connectors shall be 5 feet on the left and 10 feet on the right. A single lane freeway-to-freeway connector that has been widened to two lanes solely to provide passing opportunities and not due to capacity requirements shall have a 5-foot left shoulder and at least a 5-foot right shoulder (see Index 504.4(5)).**

(b) Three-lane Connections—**The width of shoulders on three-lane connectors shall be 10 feet on both the left and right sides.**

(5) *Single-Lane Connections*.

Freeway-to-freeway connectors may be single lane or multilane. Where design year volume is between 900 and 1500 equivalent passenger cars per hour, initial construction should provide a single lane connection with the capability of adding an additional lane. Single lane directional connectors should be designed using the general configurations shown on Figure 504.2A and 504.2B, but utilizing the flatter divergence angle shown in Figure 504.4. Single lane loop connectors may use a diverge angle of as much as that shown on Figure 504.2B for ramps, if necessary. The choice will depend upon interchange configuration and driver expectancy. Single lane connectors in excess of 1,000 feet in length should be widened to two lanes to provide for passing maneuvers (see Index 504.4(4)).

(6) *Branch Connections*.

A branch connection is defined as a multilane connection between two freeways. A branch connection should be provided when the design year volume exceeds 1500 equivalent passenger cars per hour.

Merging branch connections should be designed as shown in Figure 504.3K. Diverging branch connections should be designed as shown in Figure 504.4. The diverging branch

July 1, 2020

connection leaves the main freeway lanes on a flatter angle shown in Figure 504.4 than the standard 2-lane ramp exit connection shown in Figure 504.3K. The standard ramp exit connects to a local street. The diverging branch connection connects to another freeway and has a flatter angle that allows a higher departure speed.

At a branch merge, a 2,500-foot length of auxiliary lane should be provided beyond the merge of one lane of the inlet, except where it does not appear that capacity on the freeway will be reached until five or more years after the 20 year design period. In this case the length of auxiliary lane should be a minimum of 1,000 feet. For diverging connections where less than capacity conditions beyond the design year are anticipated, the length of auxiliary lane in advance of the exit should be 1,300 feet.

(7) *Lane Drops.*

The lane drop taper on a freeway-to-freeway connector should not be less than WV .

(8) *Metering.*

Any decision to meter freeway-to-freeway connectors must be carefully considered as driver expectancy on these types of facilities is for high-speed uninterrupted flow. If metering is anticipated on a connector, discussions with the Project Delivery Coordinator and the District Traffic Engineer or designee should take place as early as possible. Issues of particular concern are adequate deceleration lengths to the end of the queue, potential need to widen shoulders if sight distance is restricted (particularly on-ramps with 5-foot shoulders on each side), and the potential for queuing back onto the freeway

504.5 Auxiliary Lanes

In order to ensure satisfactory operating conditions, auxiliary lanes may be added to the basic width of traveled way.

Where an entrance ramp of one interchange is closely followed by an exit ramp of another interchange, the acceleration and deceleration lanes should be joined with an auxiliary lane. Auxiliary lanes are frequently used when the entrance ramp-to-exit ramp spacing, measured as shown in Figure 504.2A, is less than 2,000 feet. Where interchanges are more widely spaced and ramp volumes are high, the need for an auxiliary lane between the interchanges should be determined in accordance with Index 504.7.

Auxiliary lanes may be used for the orientation of traffic at 2-lane ramps or branch connections as illustrated on Figure 504.3K and Figure 504.4. The length and number of auxiliary lanes in advance of 2-lane exits are based on percentages of turning traffic and a weaving analysis.

Auxiliary lanes should be considered on all freeway entrance ramps with significant truck volumes. The grade, volumes and speeds should be analyzed to determine the need for auxiliary lanes. An auxiliary lane would allow entrance ramp traffic to accelerate to a higher speed before merging with mainline traffic, or simply provide more opportunity to merge. See Index 504.2 for specific requirements.

504.6 Mainline Lane Reduction at Interchanges

The basic number of mainline lanes should not be dropped through a local service interchange. The same standard should also be applied to freeway-to-freeway interchanges where less than 35 percent of the traffic is turning (see Figure 504.4). Where more than 35 percent of the freeway traffic is turning, consideration may be given to reducing the number of lanes. No

Figure 504.4

Diverging Branch Connections

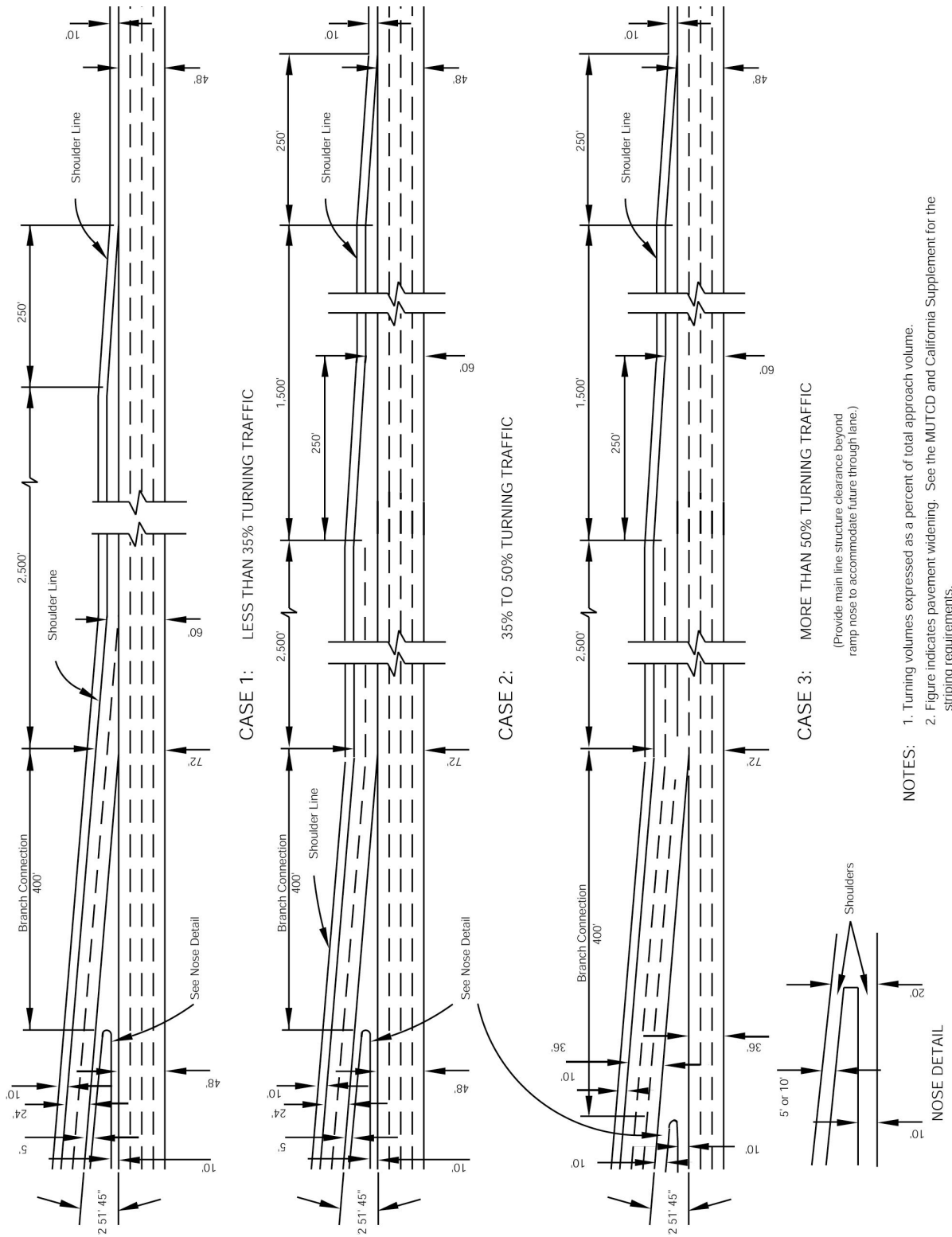

July 1, 2020

decision to reduce the number of lanes should be made without the approval of the District Traffic Operations Unit. Additionally, adequate structure clearance (both horizontal and vertical) should be provided to accommodate future construction of the dropped lane if required.

Where the reduction in traffic volumes is sufficient to warrant a decrease in the basic number of lanes, a preferred location for the lane drop is beyond the influence of an interchange and preferably at least one-half mile from the nearest exit or inlet nose. It is desirable to drop the right lane on tangent alignment with a straight or sag profile so vehicles can merge left with good visibility to the pavement markings in the merge area (see Index 201.7).

504.7 Weaving Sections

A weaving section is a length of one-way roadway where vehicles are crossing paths, changing lanes, or merging with through traffic as they enter or exit a freeway or collector-distributor road. A single weaving section has an inlet at the upstream end and an exit at the downstream end. A multiple weaving section is characterized by more than one point of entry followed by one or more points of exit.

A rough approximation for adequate length of a weaving section is one foot of length per weaving vehicle per hour. This rate will approximately provide a Level of Service (LOS) C.

There are various methods for analyzing weaving sections. Two methods which provide valid results are described below.

The Leisch method, which is usually considered the easiest to use, is illustrated in Figure 504.7A. This method was developed by Jack Leisch & Associates and may be used to determine the length of weaving sections for both freeways and collector-distributor roads. The Leisch weaving charts determine the level of service for the weaving volumes for the length of the weaving section from the first panel on the lower left of the chart. The analysis is dependent on whether the section is balanced or unbalanced, as defined in Figure 504.7B. The level of service for the total volume over all lanes of the weaving section is then found from the panels on the right of the chart. The weaving chart should not be extrapolated.

Pages 234-238 of the 1965 Highway Capacity Manual (HCM) provide a method for determining the adequacy of weaving sections near single lane ramps. It is often referred to as the LOS D method. This method is also documented in Traffic Bulletin 4 which is available from the District Division of Traffic Operations. The LOS D method can be used to project volumes along a weaving section. These volumes can be compared to the capacities along the same weaving section.

Volumes in passenger car equivalents per hour (PCEPH) should be adjusted for freeway grade and truck volumes. Table 504.7C and Figures 504.7D and E are reprinted from the 1965 HCM and provide information regarding vehicle distribution by lane.

The results obtained from Figure 504.7A (the Leisch Method) for single-lane ramps with an auxiliary lane and weaving rates exceeding 2500 PCEPH should be checked using the LOS D method.

Weaving capacity analyses other than those described above should not be used on California highways. Other methods, such as the one contained in the 1994 HCM, may not always produce accurate results.

Figure 504.7A

Design Curve for Freeway and Collector Weaving

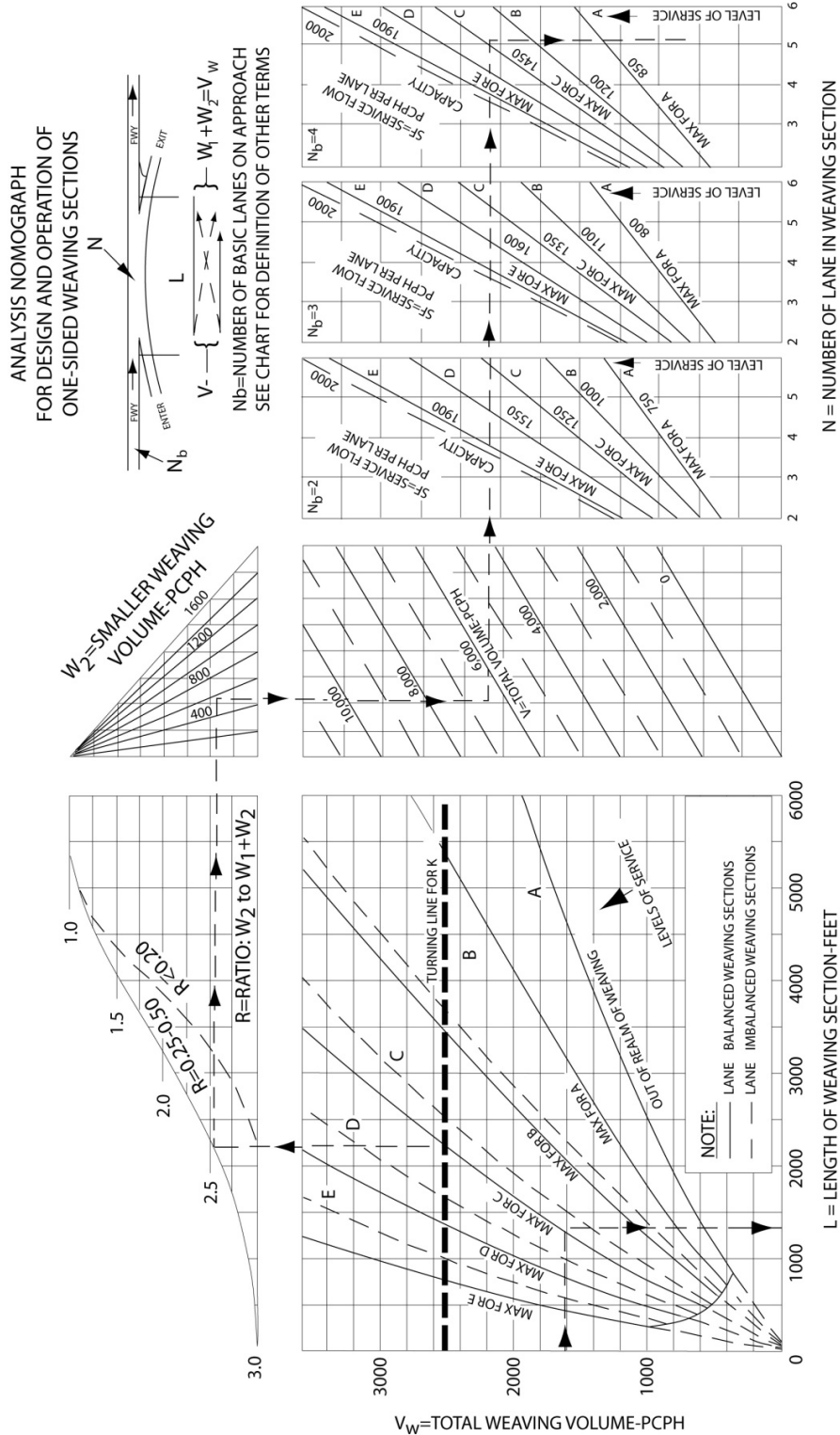

NOTE: EXTRAPOLATION OF CHART BEYOND THE BOUNDARIES GIVEN IS NOT ADVISED.

Example: The nomograph is entered on the left (see dashed line and arrows) with weaving volume, $W_1 + W_2$, (or V_w) followed by projection to the right, intersecting the desired weaving LOS; a vertical drop from this point provides weaving distance $L = 1300$ ft. Returning to first intersection point of V_w with LOS line, an upward projection along the LOS line is intersected with the horizontal, heavy dashed, "turning line for K " from here the solution line is extended vertically to intersect the K values curve, from which a horizontal extension meets the desired W_2 volume. Then a downward turn to total volume, V , from which the line is horizontally projected to the right, intersection (in this case) the desired LOS = C curve having an SF of 1450 (representing the overall or composite operation of the weaving section), from which a downward extension yields a N of 5.2; this would be rounded to $N = 5$ lanes.

July 1, 2020

Figure 504.7B

Lane Configuration of Weaving Sections

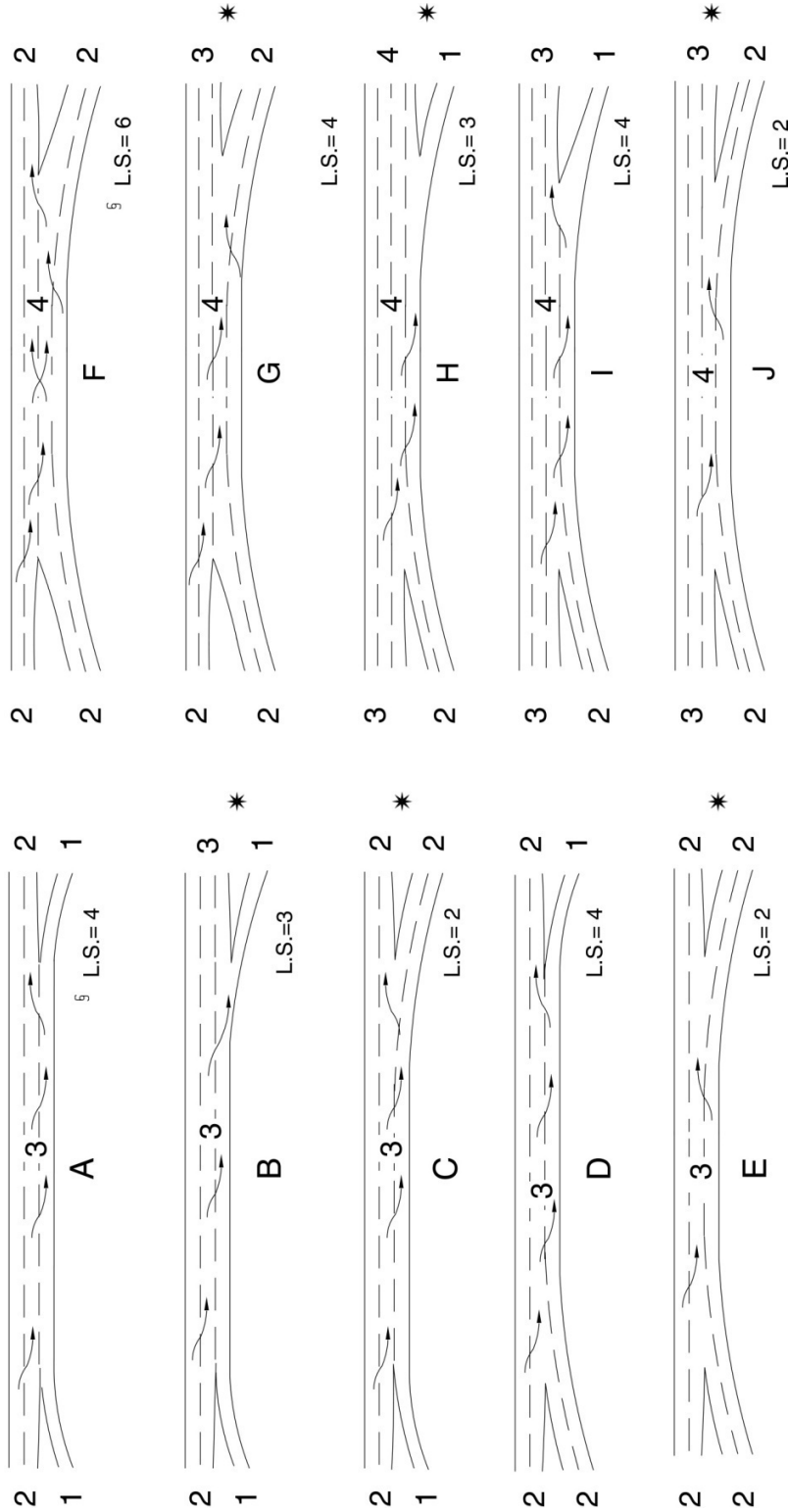

Source: Jack E. Leisch & Associates

* DENOTE LANE BALANCE - OPTIONAL LANE AT EXIT

⁵L.S. - POTENTIAL LANE SHIFTS, CONSIDERING MAX. OF 2 LANES INVOLVED ON ANY ONE APPROACH

Table 504.7C

Percent of Through Traffic Remaining in Outer Through Lane (Level of Service D Procedure)

Total Volume of Through Traffic, One Direction (vph)	Approximate Percentage of Through ⁽¹⁾ Traffic Remaining in the Outer Through Lane in the Vicinity of Ramp Terminals at Level of Service D		
	8-Lane ⁽²⁾ Freeway	6-Lane ⁽³⁾ Freeway	4-Lane ⁽⁴⁾ Freeway
6500 and over	10	-	-
6000 - 6499	10	-	-
5500 - 5999	10	-	-
5000 - 5499	9	-	-
4500 - 4999	9	18	-
4000 - 4499	8	14	-
3500 - 3999	8	10	-
3000 - 3499	8	6	40
2500 - 2999	8	6	35
2000 - 2499	8	6	30
1500 - 1999	8	6	25
Up to 1499	8	6	20

NOTES:

⁽¹⁾Traffic not involved in a ramp movement within 4,000 feet in either direction.

⁽²⁾4 lanes one-way.

⁽³⁾3 lanes one-way.

⁽⁴⁾2 lanes one-way.

July 1, 2020

Figure 504.7D

Percentage Distribution of On- and Off-ramp Traffic in Outer Through Lane and Auxiliary Lane (Level of Service D Procedure)

CASE I - SINGLE - LANE ON- AND OFF-RAMPS WITHOUT AUXILIARY LANE
 (THIS CHART MAY BE USED REGARDLESS OF ACTUAL SPACING BETWEEN ON- AND OFF-RAMPS, BUT AS NOTED BELOW* CAUTION MUST BE EXERCISED IN USING THESE VALUES.)

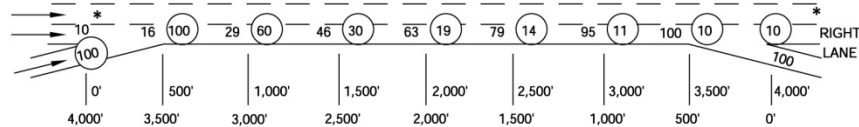

CASE II - SINGLE - LANE - ON- AND OFF-RAMPS WITH AUXILIARY LANE**

(A) L = 1,000'

EXAMPLE:

GIVEN: L = 1,000'
 PORTION OF V₁ THROUGH (FROM TABLE 504.7C = 475 VPH)
 ON-RAMP = 1,000 VPH
 OFF-RAMP = 1,200 VPH
 ON-RAMP TO OFF-RAMP = 0

FIND: V₁ (VOL. IN OUTER THROUGH LANE) @ 500' =
 $475 + (0.80)(1,000) + (0.24)(1,200) = 1,563$ VPH

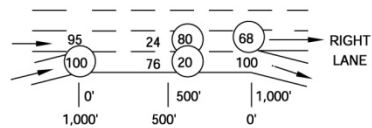

(B) L = 1,500'

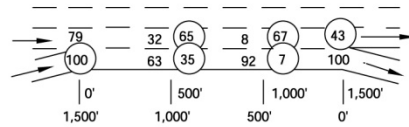

(C) L = 2,000'

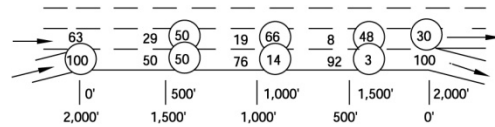

(D) L = 2,500'

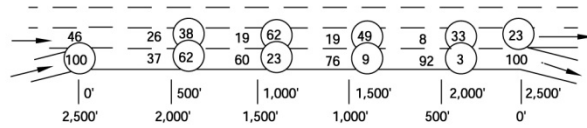

(E) L = 3,000'

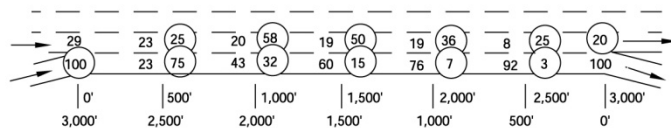

CIRCLED VALUES (O) INDICATE PERCENTAGE OF ON-RAMP TRAFFIC IN LANE SHOWN. UNCIRCLED VALUES INDICATE PERCENTAGE OF OFF-RAMP TRAFFIC IN LANE SHOWN. (REMAINING PORTION OF TRAFFIC IS IN LANE(S) TO LEFT OF OUTER THROUGH LANE.)

THESE PERCENTAGES ARE NOT NECESSARILY THE DISTRIBUTIONS UNDER FREE FLOW OR LIGHT RAMP TRAFFIC, BUT UNDER PRESSURE OF HIGH VOLUMES IN THE RIGHT LANES AT THE POINT BEING CONSIDERED AND WITH ROOM AVAILABLE IN OTHER LANES.

* MINIMUM % IN RIGHT LANE CANNOT BE LESS THAN % OF THROUGH TRAFFIC IN RIGHT LANE AS DETERMINED FROM TABLE 504.7C (SEE NOTE, FIG. 5047E).

** SEE FIGURES 504.2A AND 504.2B FOR METHOD OF MEASURING LENGTH L (WEAVING LENGTH).

Figure 504.7E

Percentage of Ramp Traffic in the Outer Through Lane (No Auxiliary Lane)
(Level of Service D Procedure)

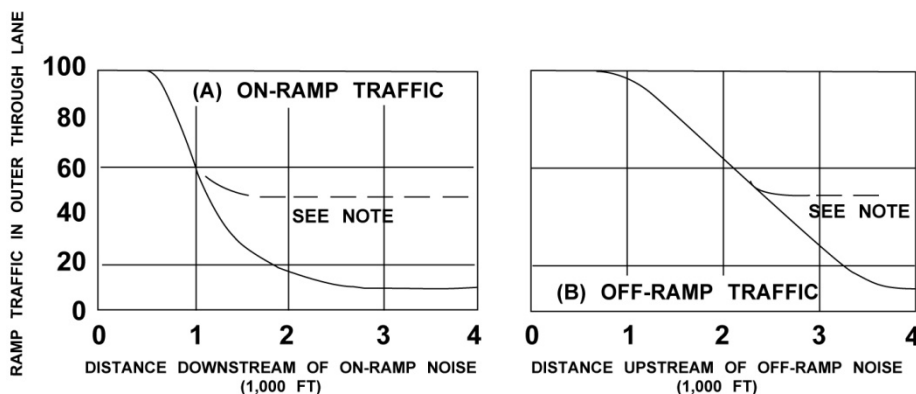

EXAMPLE:

①

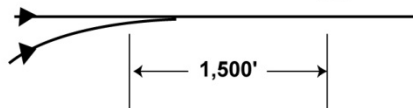

A - NORMAL CALCULATION

2 LANES ONE-WAY

"THROUGH TRAFFIC" = 2,400 VPH

"ON-RAMP" = 800 VPH

AMOUNT IN THE OUTER THROUGH LANE AT ①

THROUGH (FROM TABLE 504.7C)

$$= 0.30 \times 2,400 = 720$$

ON-RAMP (FROM CHART ABOVE)

$$= 0.30 \times 800 = \underline{240}$$

960

B - CHECK CALCULATIONS

BECAUSE % IN THE OUTER THROUGH LANE AT 1,500' IS BELOW DASHED LINE, RECALCULATE ASSUMING ON-RAMP TRAFFIC IS THROUGH TRAFFIC.

AMOUNT IN THE OUTER THROUGH LANE AT ①

THROUGH (FROM TABLE 504.7C) $0.40 \times 3,200 = 1,280$

SINCE CALCULATION B (1,280) IS GREATER THAN

CALCULATION A (960) USE 1,280.

*THESE PERCENTAGES ARE NOT NECESSARILY THE DISTRIBUTIONS UNDER FREE FLOW OR LIGHT RAMP TRAFFIC, BUT UNDER PRESSURE OF HIGH VOLUMES IN THE RIGHT LANES AT THE LOCATION BEING CONSIDERED AND WITH AVAILABLE ROOM IN OTHER LANES.

NOTE:

IF RAMP PERCENTAGE IN THE OUTER THROUGH LANE AT POINT UNDER CONSIDERATION IS BELOW DASHED LINE, THEN AMOUNT IN THE OUTER THROUGH LANE SHOULD BE RECALCULATED ASSUMING RAMP TRAFFIC IS THROUGH TRAFFIC. USE HIGHER VALUE. SEE EXAMPLE ABOVE.

July 1, 2020

The criteria contained within this Index apply to:

- New interchanges.
- Modifications to existing interchanges including access control revisions for new ramps or the relocation/elimination of existing ramps.
- Projects to increase mainline capacity when existing interchanges do not meet interchange spacing requirements.

Weaving sections in urban areas should be designed for LOS C or D. Weaving sections in rural areas should be designed for LOS B or C. Design rates for lane balanced weaving sections where at least one ramp or connector will be two lanes should not result in a LOS lower than the middle of LOS D using Figure 504.7A. Mainline through capacity is optimized when weaving movements operate at least one level of service better than the mainline level of service. In determining acceptable hourly operating volumes, peak hour factors should be used.

Between interchanges, the minimum entrance ramp-to-exit ramp spacing, measured as shown on Figures 504.2A and 504.2B shall be 2,000 feet in urban areas, 5,000 feet outside urban areas, and 5,000 feet between freeway-to-freeway interchanges and other interchanges. The volumes used must be volumes unconstrained by metering regardless of whether metering will be used. It should be noted that a weaving analysis must be considered over an entire freeway segment as weaving can be affected by other nearby ramps.

The District Traffic Operations Branch should be consulted for difficult weaving analysis problems.

504.8 Access Control

Access rights shall be acquired along interchange ramps to their junction with the nearest public road. At such junctions, for new construction, access control should extend 100 feet beyond the end of the curb return or ramp radius in urban areas and 300 feet in rural areas, or as far as necessary to ensure that entry onto the facility does not impair operational characteristics. Access control shall extend at least 50 feet beyond the end of the curb return, ramp radius, or taper.

Typical examples of access control at interchanges are shown in Figure 504.8. These illustrations do not presume to cover all situations or to indicate the most desirable designs for all cases. When there is state-owned access control on both sides of a local road, a maintenance agreement may be needed.

For new construction or major reconstruction, access rights shall be acquired on the opposite side of the local road from ramp terminals to preclude driveways or local roads within the ramp intersection. This access control would limit the volume of traffic and the number of phases at the intersection of the ramp and local facility, thereby optimizing capacity and operation of the ramp. Through a combination of access control and the use of raised median islands along the local facility, right-in/right-out access may be permitted beyond 200 feet from the ramp intersection. The length of access control on both sides of the local facility should match. See Index 504.3(3) for further ramp intersection guidance on the crossroads.

Figure 504.8

Typical Examples of Access Control at Interchanges

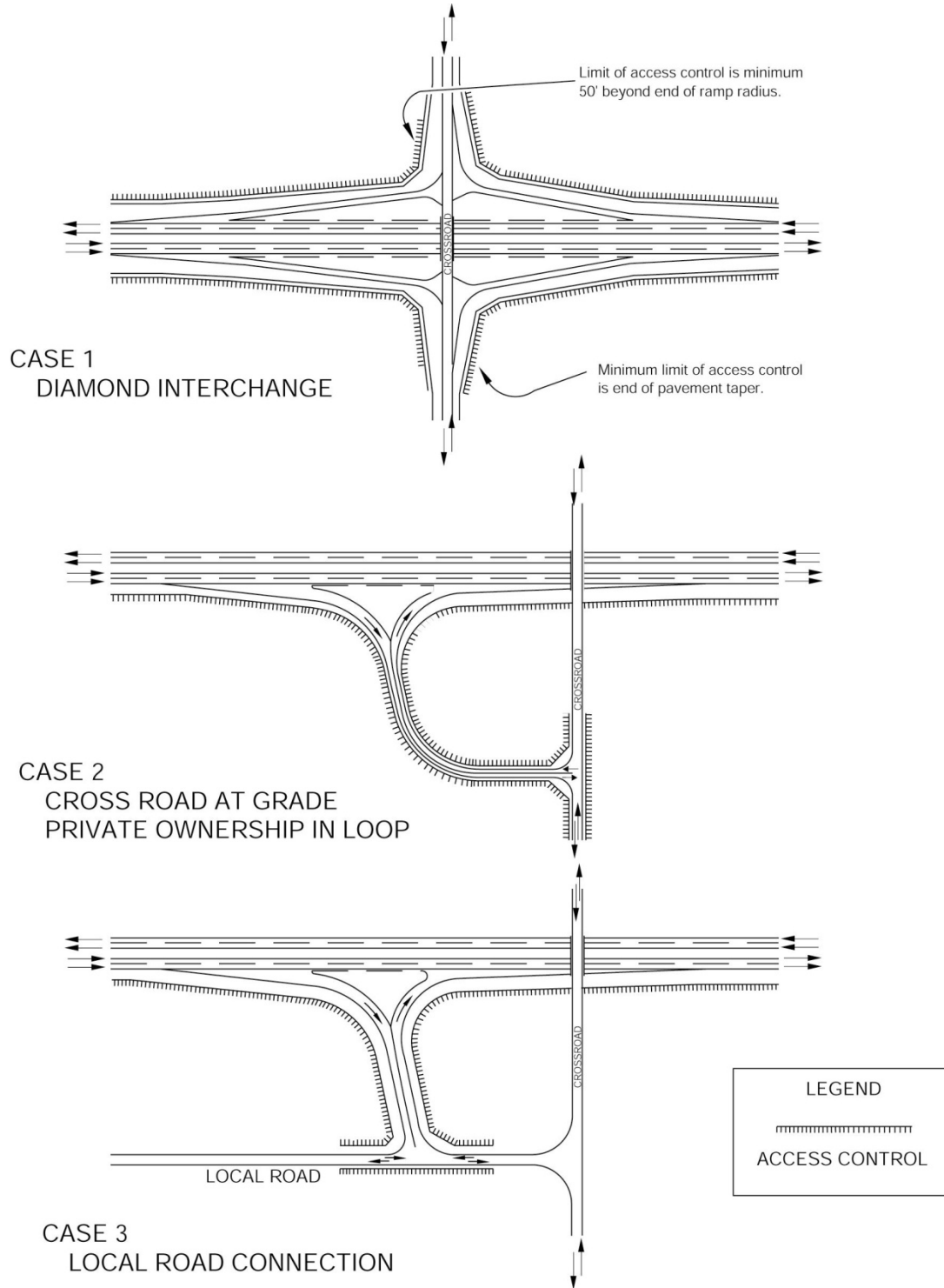

July 1, 2020

Figure 504.8

Typical Examples of Access Control at Interchanges (Cont.)

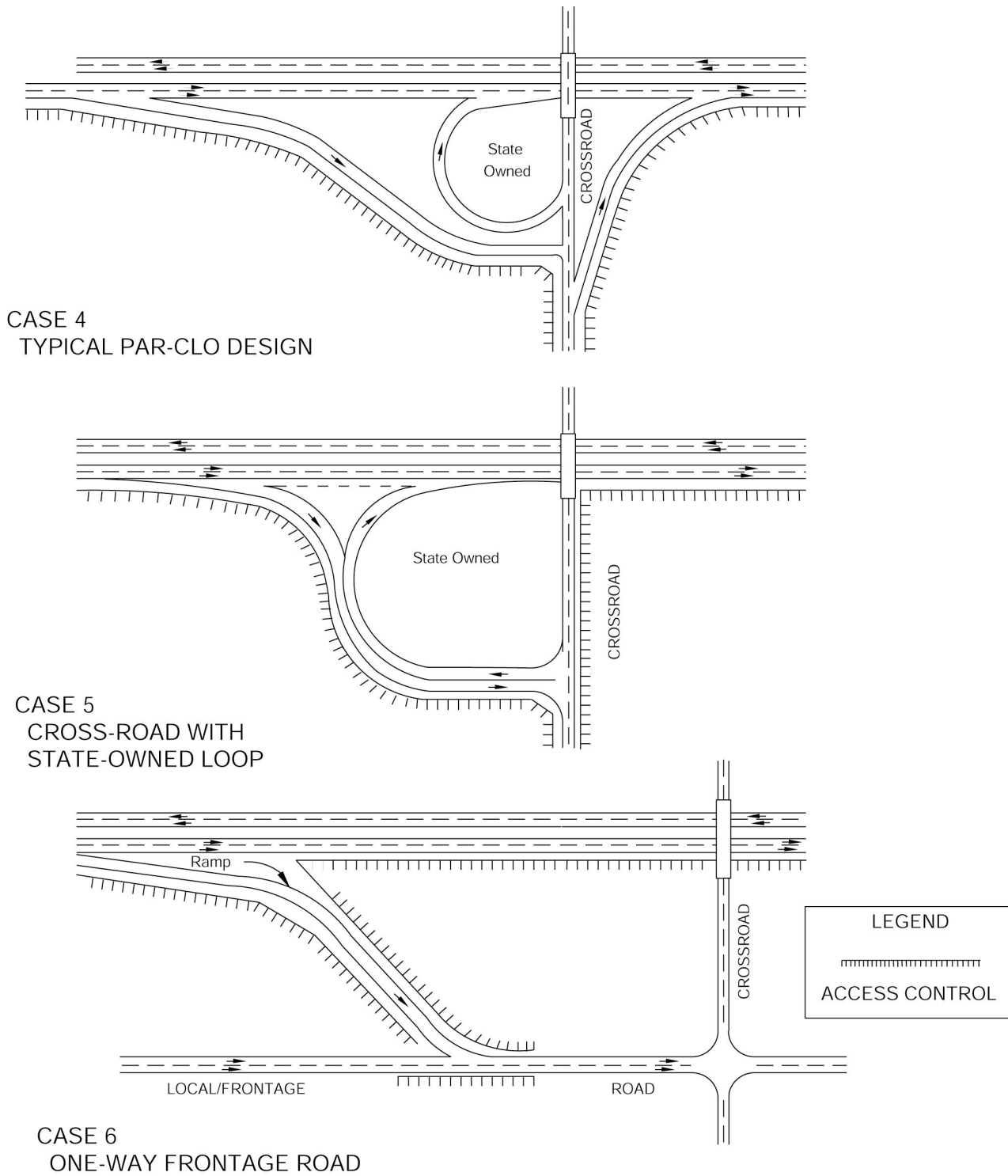

In Case 2 consider private ownership within the loop only if access to the property is an adequate distance from the ramp junction to preserve operational integrity.

In Case 3 if the crossroads is near the ramp junction at the local road, full access control should be acquired on the local road from the junction to the intersection with the crossroad.

Case 6 represents a slip ramp design. If the ramp is perpendicular to the local/frontage road refer to Case 3. In Case 6 if the crossroad is near the ramp junction to the local/frontage road, access control should be acquired on the opposite side of the local road from the junction.

