

CHANGE LETTER TRENCHING AND SHORING MANUAL – Revision No. 01

OSC TRENCHING AND SHORING MANUAL

September 12, 2011

Attached are revisions to the Trenching and Shoring Manual. Please make the following changes in your manual:

SECTION	REMOVE	DATED	SECTION	INSERT	DATED
MANUAL COVER	REVISION 01	06/11	MANUAL COVER	REVISION 01	08/11
LIST OF FIGURES	PAGES ix, x	06/11	LIST OF FIGURES	PAGES ix, x	08/11
CHAPTER 4	EARTH PRESSURE THEORY AND APPLICATION	06/11	CHAPTER 4	EARTH PRESSURE THEORY AND APPLICATION	08/11
CHAPTER 8	RAILROAD	06/11	CHAPTER 8	RAILROAD	08/11

Chapter 4, “Earth Pressure Theory and Application”, is revised to correct Equation 4-43 from:

$$P_p = \frac{W[\tan(\alpha + \phi)] + C_o L_c [\sin \alpha \tan(\alpha - \phi) + \cos \alpha] + C_a L_a [\tan(\alpha - \phi) \cos(-\omega) + \sin \omega]}{[1 - \tan(\delta + \omega) \tan(\alpha + \phi)] \cos(\delta + \omega)}$$

to:

$$P_p = \frac{W[\tan(\alpha + \phi)] + C_o L_c [\sin \alpha \tan(\alpha + \phi) + \cos \alpha] + C_a L_a [\tan(\alpha + \phi) \cos(-\omega) + \sin \omega]}{[1 - \tan(\delta + \omega) \tan(\alpha + \phi)] \cos(\delta + \omega)}$$

Chapter 8, “Railroad”, is revised to correct the application of the boussinesq loading to comply with the Railroad's Guidelines for Temporary Shoring. The guidelines infer that the railroad live load should start at the top of the shoring system and not at the top of the railroad roadbed.

These changes are reflected as follows:

- Pages revised: 4-27, 8-2, 8-17, 8-19 to 8-25, 8-27 to 8-31.
- Figures revised: 8-1, 8-8, 8-9, 8-10, 8-12, and 8-14.
- Tables revised: 8-3 thru 8-7.
- Page added: 8-32.
- Figure added: 8-15.



ROBERT A. STOTT, Deputy Division Chief
Offices of Structure Construction

STATE OF CALIFORNIA

DEPARTMENT OF TRANSPORTATION

TRENCHING

AND

SHORING

MANUAL

ISSUED BY
OFFICES OF STRUCTURE CONSTRUCTION

Copyright © 2011 California Department of Transportation.
All rights reserved.

Revision 1
August 2011

TABLE OF CONTENTS

CHAPTER 1 LEGAL REQUIREMENTS

1.0	LEGAL REQUIREMENTS AND RESPONSIBILITIES	1-1
1.1	LABOR CODE.....	1-3
1.2	Cal/OSHA	1-4
1.3	STATE STATUTES.....	1-7
1.4	FEDERAL HIGHWAY ADMINISTRATION (FHWA)	1-7
1.5	RAILROAD RELATIONS AND REQUIREMENTS.....	1-8
1.6	SHORING PLANS.....	1-9
1.7	SUMMARY	1-11

CHAPTER 2 Cal/OSHA

2.0	Cal/OSHA	2-1
2.1	SOME IMPORTANT Cal/OSHA DEFINITIONS	2-3
2.2	SOME IMPORTANT Cal/OSHA REQUIREMENTS	2-5
2.2.1	General Requirements Section 1541.....	2-5
2.2.2	Protective System Selection.....	2-6
2.2.3	Soil Classification	2-8
2.2.4	Sloping or Benching Systems	2-10
2.2.5	Timber Shoring for Trenches.....	2-12
2.2.6	Aluminum Hydraulic Shoring for Trenches	2-14
2.2.7	Shield Systems	2-15
2.3	MANUFACTURED PRODUCTS.....	2-15
2.4	ALTERNATE DESIGN CONSIDERATIONS	2-17
2.5	INFORMATION ABOUT TEXT FORMATTING IN THE CONSTRUCTION SAFETY ORDERS	2-17

CHAPTER 3 SOILS

3.0	INTRODUCTION.....	3-1
3.1	SOIL IDENTIFICATION, CLASSIFICATION, DESCRIPTION AND PRESENTATION	3-1
3.2	SOIL PROPERTIES and STRENGTH.....	3-3
3.3	STANDARD PENETRATION TEST (SPT).....	3-4
3.4	CONE PENETRATION TEST (CPT).....	3-6
3.5	FIELD and LABORATORY TESTS.....	3-8
3.6	SHEAR STRENGTH.....	3-9
3.7	CONTRACTOR SOIL INVESTIGATIONS.....	3-10
3.8	SPECIAL GROUND CONDITIONS	3-11

CHAPTER 4 EARTH PRESSURE THEORY AND APPLICATION

CT TRENCHING AND SHORING MANUAL

4.0	GENERAL	4-1
4.1	SHORING TYPES	4-1
4.1.1	Unrestrained Shoring Systems	4-1
4.1.2	Restrained Shoring Systems	4-1
4.2	LOADING	4-2
4.3	GRANULAR SOIL	4-4
4.3.1	At-Rest Lateral Earth Pressure Coefficient (K_0)	4-10
4.3.2	Active and/or Passive Earth Pressure	4-11
4.3.2.1	Rankine's Theory	4-11
4.3.2.2	Coulomb's Theory	4-14
4.4	COHESIVE SOIL	4-19
4.5	SHORING SYSTEMS AND SLOPING GROUND	4-24
4.5.1	Active Trial Wedge Method	4-25
4.5.2	Passive Trial Wedge Method	4-27
4.5.3	Culmann's Graphical Solution for Active Earth Pressure	4-28
4.5.3.1	Example 4-1 Culmann Graphical Method	4-33
4.5.3.2	Example 4-2 Trial Wedge Method	4-37
4.5.3.3	Example 4-3 (AREMA Manual page 8-5-12)	4-39
4.5.3.4	Example 4-4 (AREMA Manual page 8-5-12)	4-43
4.5.3.5	Example 4-5 (AREMA Manual page 8-5-13)	4-45
4.5.3.6	Example 4-6 (AREMA Manual page 8-5-13)	4-48
4.6	EFFECT OF WALL FRICTION	4-50
4.7	LOG SPIRAL PASSIVE EARTH PRESSURE	4-50
4.7.1	Composite Failure Surface	4-52
4.7.1.1	Force Equilibrium Procedures	4-52
4.7.1.2	Moment Equilibrium Procedures	4-55
4.7.2	Noncomposite Log Spiral Failure Surface	4-60
4.7.2.3	Force Equilibrium Method	4-60
4.7.2.4	Moment Equilibrium Method	4-61
4.8	SURCHARGE LOADS	4-70
4.8.1	Minimum Construction Surcharge Load	4-70
4.8.2	Uniform Surcharge Loads	4-71
4.8.3	Boussinesq Loads	4-72
4.8.3.1	Strip Load	4-72
4.8.3.2	Line Load	4-73
4.8.3.3	Point Load	4-74
4.8.4	Traffic Loads	4-76
4.8.4.1	Example 4-7 Sample Problem – Surcharge Loads	4-79
4.8.5	Alternate Surcharge Loading (Traffic)	4-80

CHAPTER 5 STRUCTURAL DESIGN OF SHORING SYSTEMS

5.0	INTRODUCTION	5-1
5.1	ALLOWABLE WORKING STRESSES	5-1

TABLE OF CONTENTS

5.1.1	Timber.....	5-1
5.1.2	Steel.....	5-2
5.2	MECHANICS OF STRESS ANALYSIS	5-5
5.3	OVERSTRESS.....	5-7
5.4	LAGGING.....	5-7

CHAPTER 6 UNRESTRAINED SHORING SYSTEMS

6.0	TYPES OF UNRESTRAINED SHORING SYSTEMS	6-1
6.1	LATERAL EARTH PRESSURES FOR UNRESTRAINED SHORING SYSTEMS	6-2
6.2	EFFECTIVE WIDTH.....	6-9
6.3	DEFLECTION	6-11
6.4	SOIL PRESSURE DISTRIBUTION FOR LAYERED SOIL	6-13
6.4.1	Example 6-1 Cantilevered Soldier Pile Wall	6-14
6.4.2	Example 6-2 Cantilevered Soldier Pile Wall	6-17
6.4.3	Example 6-3 Deflection of a Cantilevered Soldier Pile Wall	6-23

CHAPTER 7 RESTRAINED SHORING SYSTEMS

7.0	LATERAL EARTH PRESSURES FOR RESTRAINED SHORING SYSTEMS	7-1
7.1	COHESIONLESS SOILS	7-2
7.2	COHESIVE SOILS	7-5
7.2.1	Stiff to Hard	7-5
7.2.2	Soft to Medium Stiff.....	7-6
7.3	CALCULATION PROCEDURES.....	7-8
7.3.1	Single Tieback/Brace System	7-8
7.3.2	Multiple Tieback/Brace System.....	7-10
7.3.3	Deflection.....	7-13
7.3.4	Example 7-1 Single Tieback Sheet Pile Wall	7-14
7.3.5	Example 7-2 Multiple Tieback Sheet Pile Wall	7-23

CHAPTER 8 RAILROAD

8.0	INTRODUCTION.....	8-1
8.1	SELECTED EXCERPTS FROM “Guidelines for Temporary Shoring”	8-2
8.1.1	Scope.....	8-2
8.1.2	General Criteria.....	8-2
8.1.3	Types of Temporary Shoring	8-4
8.1.3.1	Shoring Box	8-4
8.1.3.2	Restrained Systems	8-4
8.1.3.3	Unrestrained Systems.....	8-4
8.1.3.4	Cofferdam	8-4
8.1.4	General Shoring Requirements	8-5

CT TRENCHING AND SHORING MANUAL

8.1.5	Information Required.....	8-6
8.1.5.1	Field Survey.....	8-6
8.1.5.2	Geotechnical Report.....	8-6
8.1.5.3	Loads.....	8-7
8.1.5.4	Drainage (AREMA 8.20.2.4).....	8-8
8.1.5.5	Structural Design Calculations	8-8
8.1.5.6	Computation of Applied Forces.....	8-8
8.1.5.7	Structural Integrity	8-9
8.2	EXAMPLE 8-1 (Railroad Example).....	8-14
8.3	DEFLECTION CALCULATION.....	8-27

CHAPTER 9 CONSTRUCTION AND SPECIAL CONSIDERATIONS

9.0	SPECIAL CONDITIONS	9-1
9.1	ANCHOR BLOCK.....	9-2
9.1.1	Anchor Block in Cohesionless Soil	9-3
9.1.2	Anchor Block in Cohesionless Soil where $1.5 \leq D/H \leq 5.5$	9-9
9.1.3	Anchor Block in Cohesive Soil near the Ground Surface $D \leq H/2$	9-10
9.1.4	Anchor Blocks in Cohesive Soil where $D \geq H/2$	9-12
9.1.4.1	Example 9-1 Problem – Anchor Blocks	9-13
9.2	HEAVE	9-16
9.2.1	Factor of Safety Against Heave	9-18
9.2.1.1	Example 9-2 Problem – Heave Factor of Safety	9-20
9.3	PIPING.....	9-21
9.3.1	Hydraulic Forces on Cofferdams and Other Structures.....	9-21
9.4	SLOPE STABILITY	9-23
9.4.1	Rotational Slides	9-24
9.4.2	Fellenius Method	9-28
9.4.2.1	Example 9-3 Problem – Fellenius Method	9-29
9.4.3	Bishop Method.....	9-31
9.4.3.1	Example 9-4 Problem – Bishop Method.....	9-32
9.4.4	Translational Slide	9-33
9.4.4.1	Example 9-5 Problem – Translational Slide	9-36
9.4.5	Stability Analysis of Shoring Systems.....	9-37
9.4.6	The Last Word on Stability.....	9-37
9.5	CONSTRUCTION CONSIDERATIONS	9-38
9.5.1	Construction.....	9-38
9.5.2	Encroachment Permit Projects.....	9-41
9.5.3	Tieback Systems	9-44
9.5.3.1	Construction Sequence.....	9-44
9.5.3.2	Tieback Anchor Systems	9-44
9.5.3.3	Tieback Anchor.....	9-47
9.5.3.4	Forces on the Vertical Members	9-50
9.5.3.5	Testing Tieback Anchors	9-51

TABLE OF CONTENTS

9.5.3.6	Proof Testing.....	9-53
9.5.3.7	Evaluation of Creep Movement.....	9-55
9.5.3.8	Wall Movement and Settlement.....	9-56
9.5.3.9	Performance Testing.....	9-56
9.5.3.10	Lock-Off Force	9-57
9.5.3.11	Corrosion Protection.....	9-58
9.5.3.12	Steps for Checking Tieback Shoring Submittal.....	9-59
9.5.3.13	Example 9-6 Tieback Testing	9-60
9.6	SUMMARY	9-62

**Appendix A CALIFORNIA OCCUPATIONAL SAFETY AND HEALTH
STANDARDS FOR EXCAVATIONS**

Appendix B Memos

Appendix C Surcharges

Appendix D Sheet Piles

Appendix E Examples

Appendix F Brochures

Appendix G Notes & FAQ's

CT TRENCHING AND SHORING MANUAL

LIST OF FIGURES

Figure 3-1. Cone Penetration Test (CPT) Boring	3-6
Figure 3-2. Typical CPT Plot.....	3-7
Figure 3-3. Mohr-Coulomb Criteria	3-9
Figure 4-1. Active and passive earth pressure coefficient as a function of wall displacement ...	4-2
Figure 4-2. Comparison of Plane versus Curve Failure Surfaces.....	4-4
Figure 4-3. Lateral Earth Pressure Variation with Depth	4-5
Figure 4-4. Mohr Circle Representation of Earth Pressure for Cohesionless Backfill.....	4-7
Figure 4-5. Rankine’s active wedge.....	4-12
Figure 4-6. Rankine’s passive wedge	4-13
Figure 4-7. Coulomb’s active wedge.....	4-15
Figure 4-8. Coulomb’s passive wedge.....	4-16
Figure 4-9. Mohr Circle Representation of Earth Pressure for Cohesive Backfill	4-19
Figure 4-10. Tension crack with hydrostatic water pressure	4-20
Figure 4-11. Cohesive Soil Active Passive Earth Pressure Distribution	4-21
Figure 4-12: Load Distribution for Cohesive Backfill.....	4-22
Figure 4-13. Sloping Ground	4-24
Figure 4-14. Active Trial Wedge.....	4-26
Figure 4-15. Passive Trial Wedge.....	4-27
Figure 4-16. Single Wedge and Force Polygon.....	4-28
Figure 4-17. Culmann Trial Wedges	4-30
Figure 4-18. Culmann Graphical Solution to Scale.....	4-32
Figure 4-19. Retaining Wall with Irregular backfill by Culmann Method.....	4-33
Figure 4-20. Culmann Trial Wedge Method to Scale.....	4-34
Figure 4-21. Culmann Graphical Solution Using Force Polygon.....	4-36
Figure 4-22. Critical Active Wedge.....	4-37
Figure 4-23. Culmann AREMA page 8-5-12	4-39
Figure 4-24. Culmann Trial Wedge.....	4-40
Figure 4-25. Culmann Graphical Solution Using Force Polygon.....	4-42
Figure 4-26. Critical Active Wedge Method	4-43
Figure 4-27. Retaining Wall with Irregular backfill	4-45
Figure 4-28. Culmann Trial Wedge	4-46
Figure 4-29. Culmann Force Polygon.....	4-47
Figure 4-30. Critical Active Wedge.....	4-48
Figure 4-31. Passive Active failure surface; straight line versus spiral surface of sliding.	4-50
Figure 4-32. Geometry of the developing mobilized failure plane (Shamsabadi, <i>et al.</i> , 2005). ..	4-51
Figure 4-33. Geometry of the failure surface and associated interslice forces.....	4-54
Figure 4-34. Geometry of the failure surface due to weight.....	4-55
Figure 4-35. Geometry of the failure surface due to cohesion.	4-56
Figure 4-36. Moment Method.....	4-57
Figure 4-37. Passive earth pressure coefficient (Caquot and Kerisel, 1948).....	4-59
Figure 4-38. Mobilized full log spiral failure surface.....	4-60
Figure 4-39. Mobilized full log spiral failure surface for cohesion component.....	4-61
Figure 4-40. Log Spiral – Forces Method – Full Log Spiral – Trial	4-62
Figure 4-41. Log Spiral – Forces Method – Full Log Spiral – No Trial.....	4-63
Figure 4-42. Log Spiral – Forces Method – Composite Failure Surface.....	4-64
Figure 4-43. Log Spiral – Modified Moment Method – Composite Failure Surface	4-65

CT TRENCHING AND SHORING MANUAL

Figure 4-44. Log Spiral – Moment Method – Full Log Spiral Failure Surface.....	4-66
Figure 4-45. Log Spiral – Moment Method – Composite Failure Surface.....	4-67
Figure 4-46. Log Spiral – see Figure 4-37.....	4-68
Figure 4-47. Minimum Lateral Surcharge Load.....	4-70
Figure 4-48. Boussinesq Type Strip Load.....	4-72
Figure 4-49. Boussinesq Type Line Load.....	4-73
Figure 4-50. Boussinesq Type Point Load.....	4-74
Figure 4-51. Boussinesq Type Point Load with Lateral Offset.....	4-75
Figure 4-52. Alternate Traffic Surcharge Loading.....	4-80
Figure 5-1. Soil Arching.....	5-7
Figure 6-1. Sheet Pile Wall with Cap Beam.....	6-1
Figure 6-2. Soldier Pile Wall with Cap Beam.....	6-2
Figure 6-3. Cantilever Retaining Walls.....	6-3
Figure 6-4. Loading Diagram for Single Layer.....	6-4
Figure 6-5. Loading Diagram for Multi-Layer Soil.....	6-5
Figure 6-6. Loading Diagram for Multi-Layer.....	6-6
Figure 6-7. Loading Diagram for Multi-Layer.....	6-7
Figure 6-8. Loading Diagram for Multi-Layer.....	6-8
Figure 6-9. Soldier Pile with Arching.....	6-9
Figure 6-10. Deflected Shape for Unrestrained System.....	6-12
Figure 6-11. Multilayer soil pressure.....	6-13
Figure 6-12. Example 6-1.....	6-14
Figure 6-13. Pressure Loading Diagram.....	6-15
Figure 6-14. Force Loading Diagram.....	6-16
Figure 6-15. Soldier pile with sloping ground Example 6-2.....	6-17
Figure 6-16. Active and Passive Earth Pressure Coefficients.....	6-18
Figure 6-17. Pressure Diagram.....	6-20
Figure 6-18. Location of Zero Shear and Maximum Moment.....	6-21
Figure 6-19. Loading Diagram.....	6-24
Figure 6-20. Shear Diagram.....	6-24
Figure 6-21. Moment Diagram.....	6-25
Figure 6-22. Deflected Shape.....	6-25
Figure 6-23. Moment Area diagram.....	6-26
Figure 6-24. Redeveloped shear and moments diagrams.....	6-28
Figure 6-25. Loading Diagram.....	6-30
Figure 6-26. Shear Diagram.....	6-30
Figure 6-27. Moment Diagram.....	6-30
Figure 6-28. Deflection Diagram.....	6-30
Figure 7-1. Lateral Earth Pressure for Anchored/Braced Walls.....	7-1
Figure 7-2. Pressure Diagram for Single Anchored/Braced Wall.....	7-2
Figure 7-3. Pressure Diagram for Multi Anchored/Braced Wall.....	7-4
Figure 7-4. Pressure Diagram for Multi Anchored/Braced Wall for Cohesive Backfill.....	7-6
Figure 7-5. Single Tieback System.....	7-9
Figure 7-6. Multiple Tieback System.....	7-11
Figure 7-7. Detail Hinge Method for Tieback Analysis.....	7-12
Figure 7-8. Deflected Shape for Restrained System.....	7-13

LIST OF FIGURES

Figure 7-9. Example 7-1	7-14
Figure 7-10. Pressure Diagram for Single Tieback Wall.....	7-16
Figure 7-11. Pressure Diagram	7-17
Figure 7-12. Pressure Diagram For Single-Tieback Above Dredge Line	7-19
Figure 7-13. Zero shear.....	7-21
Figure 7-14. Pressure Diagram	7-22
Figure 7-15. Shear Diagram.....	7-22
Figure 7-16. Moment Diagram	7-22
Figure 7-17. Deflection Diagram.....	7-22
Figure 7-18. Example 7-2	7-23
Figure 7-19. Pressure Diagram For Multi-Tieback.....	7-24
Figure 7-20. Pressure Diagram For Multi-Tieback Above Dredge Line.....	7-26
Figure 7-21. Point of zero shear.....	7-29
Figure 7-22. Pressure Diagram	7-31
Figure 7-23. Shear Diagram.....	7-31
Figure 7-24. Moment Diagram	7-31
Figure 7-25. Deflection Diagram.....	7-31
Figure 8-1. Railroad Boussinesq Strip Load.....	8-2
Figure 8-2. General Railroad Requirements (GTS section 6, p6).....	8-11
Figure 8-3. Live Load Pressure due to Cooper E80 (GTS section 7, p8).....	8-12
Figure 8-4. Cooper E80 Loading (GTS section 7, p8).....	8-13
Figure 8-5. EXAMPLE 8-1.....	8-14
Figure 8-6. Final Trial Wedge For EXAMPLE 8-1	8-15
Figure 8-7. Boussinesq Type Strip Load for Railroad.....	8-18
Figure 8-8. General Pressure Diagram.....	8-19
Figure 8-9. Combined Pressure Diagram (No Scale)	8-20
Figure 8-10. Final Load, Shear, and Moment Diagrams for EXAMPLE 8-1	8-23
Figure 8-11. Deflected Shape of Shoring System.....	8-27
Figure 8-12. Schematic of Load, Moment and Deflection Diagrams for EXAMPLE 8-1	8-28
Figure 8-13. Deflected Shape of Shoring System above the Tieback	8-30
Figure 8-14. Final Deflected Shape of Shoring System	8-31
Figure 8-15. Diagrams per CT-TSP.....	8-32
Figure 9-1. Anchor Block and Tie Rod	9-2
Figure 9-2. Anchor block.....	9-2
Figure 9-3. Anchor block in cohesionless soil near ground surface.....	9-3
Figure 9-4. Anchor block in 3D (Shamsabadi, A., Nordal, S. (2006)).....	9-5
Figure 9-5. Section A-A (Shamsabadi, A., <i>et al.</i> , 2007).....	9-5
Figure 9-6. Anchor block not near the ground surface	9-7
Figure 9-7. Anchor block in cohesionless soil $1.5 \leq D/H \leq 5.5$	9-9
Figure 9-8. Anchor block in cohesive soil near ground $D \leq H/2$	9-10
Figure 9-9. Anchor block in cohesive soil $D \geq H/2$	9-12
Figure 9-10. Anchor block Example 9-1	9-13
Figure 9-11. Anchor block Example 9-1 solution	9-14
Figure 9-12. Bottom Heave.....	9-17
Figure 9-13. Bearing Capacity Factor.....	9-18
Figure 9-14. Factor of safety.....	9-19

CT TRENCHING AND SHORING MANUAL

Figure 9-15. Heave example problem.....	9-20
Figure 9-16. Hydraulic forces on cofferdams	9-22
Figure 9-17. Common pattern of soil slope failure (USGS).....	9-23
Figure 9-18. Method of slices and forces acting on a slice.....	9-25
Figure 9-19. A Trial Surface, for Fellenius and Bishop method of slices	9-27
Figure 9-20. Slice i, Fellenius Method.....	9-28
Figure 9-21. Example of Fellenius and Bishop method of slices	9-29
Figure 9-22. Slice i, Bishop Method.....	9-31
Figure 9-23. Mechanism of Translational Slide	9-33
Figure 9-24. Mechanism of Translational Slide	9-34
Figure 9-25. Example of a Translational Slide	9-36
Figure 9-26. Stability failure modes	9-37
Figure 9-27. Typical temporary tieback.....	9-45
Figure 9-28. Anchor shapes	9-47
Figure 9-29. Bond Length.....	9-49
Figure 9-30. Proof Testing.....	9-54
Figure 9-31. Bar or Strand Tendons	9-59

LIST OF TABLES

Table 3-1. Properties Granular Soils.....	3-4
Table 3-2. Simplified Typical Soil Values	3-5
Table 3-3. Properties Cohesive Soils.....	3-6
Table 3-4. Field and Laboratory Test Reliability of Soil Shear Strength Measurements.....	3-8
Table 4-1. Mobilized Wall Movements	4-3
Table 4-2. Wall friction.....	4-18
Table 4-3. Culmann Graphical Method Results	4-35
Table 4-4. Culmann Trial Wedge Method Results	4-41
Table 4-5. Culmann Graphical Method Results	4-47
Table 4-6. K_{ph} based on straight or curved rupture lines with zero slope backfill ($\beta = 0^\circ$).....	4-69
Table 5-1. Laterally Supported Beams	5-3
Table 5-2. FHWA Recommended Minimum Timber Thickness	5-9
Table 6-1. Arching Capability Factor	6-10
Table 6-2. Arching Capability for Cohesive Soil	6-10
Table 6-3. Calculations for deflection	6-29
Table 8-1. Deflection Criteria	8-11
Table 8-2. Boussinesq loads at various depths	8-19
Table 8-3. Calculated Driving and Resisting Moments.....	8-21
Table 8-4. Determining Moment Diagram Values	8-24
Table 8-5. Calculations for deflection δ_p	8-29
Table 8-6. Calculations for deflection δ_l	8-30
Table 8-7. Calculations for deflection δ_3	8-31
Table 9-1. Fellenius Table of Slices	9-30
Table 9-2. Tieback Proof Test Criteria	9-51

CT TRENCHING AND SHORING MANUAL

LIST OF EXAMPLES

Example 4-1	Culman Graphical Method	4-33
Example 4-2	Trial Wedge Method	4-37
Example 4-3	(AREMA Manual page 8-5-12)	4-39
Example 4-4	(AREMA Manual page 8-5-12)	4-43
Example 4-5	(AREMA Manual page 8-5-13)	4-45
Example 4-6	(AREMA Manual page 8-5-13)	4-48
Example 4-7	Sample Problem – Surcharge Loads	4-79
Example 6-1	Cantilevered Soldier Pile Wall	6-14
Example 6-2	Cantilevered Soldier Pile Wall	6-17
Example 7-1	Single Tieback Sheet Pile Wall	7-14
Example 7-2	Multiple Tieback Sheet Pile Wall	7-23
Example 8-1	(Railroad Example)	8-14
Example 9-1	Problem – Anchor Blocks	9-13
Example 9-2	Problem – Heave Factor of Safety	9-20
Example 9-3	Problem – Fellenius Method	9-29
Example 9-4	Problem – Bishop Method.....	9-32
Example 9-5	Problem – Translational Slide	9-36
Example 9-6	Tieback Testing	9-60

CT TRENCHING AND SHORING MANUAL

NOMENCLATURE

C	=	Cohesive intercept: Component of soil shear strength which is independent of the force pushing the particles together.
E	=	Modulus of elasticity (psi)
GW	=	Ground water surface
I	=	Moment of inertial (in ⁴)
K _a	=	Lateral earth pressure coefficient for active pressure condition
K _o	=	Lateral earth pressure coefficient for at-rest condition
K _p	=	Lateral earth pressure coefficient for passive pressure condition
K _w	=	Equivalent fluid soil pressure (pcf)
K _{ph}	=	Horizontal component of lateral earth pressure coefficient for passive pressure condition
K _{pv}	=	Vertical component of lateral earth pressure coefficient for passive pressure condition
N	=	Standard penetration resistance
N _c	=	Bearing capacity factor
N ₀	=	Stability number
Q	=	Level surcharge loading (pcf)
qu	=	Unconfined compressive strength (psf)
S	=	Section Modules (in ³)
Sb	=	Bond Strength (psf) frictional force between soil and tieback anchor
SF	=	Safety Factor
SU	=	Undrained shear strength
α - Alpha	=	Angle from vertical to center of surcharge strip
β - Beta	=	Angle of soil slope
γ - Gamma	=	Unit Weight of soil (pcf)
δ - Delta	=	Wall friction angle
ε - Epsilon	=	Linear strain
θ - Theta	=	Angle of repose
μ - Mu	=	Angle of tieback with horizontal
ρ - Rho	=	Degree of flexibility of an anchored bulkhead (Rowe's Moment Reduction theory)
σ - Sigma	=	Normal stress
Σ - Sigma	=	Sum
τ - Tau	=	Soil shear stress
υ - Upsilon	=	Poisson's ratio
φ - Phi	=	Angle of internal friction of soil
ψ - Psi	=	Failure wedge or slip angle
ω - Omega	=	Angle of the wall with respect to vertical
FHWA	=	Federal Highway Administration
AREA	=	American Railway Engineering Association
AREMA	=	American Railway Engineering and Maintenance-of-Way Association
Cal-OSHA	=	California Occupational Safety and Health Administration

CT TRENCHING AND SHORING MANUAL

PREFACE

The California Department of Transportation Trenching & Shoring Manual was originally developed by the Offices of Structure Construction in 1977. Its purpose then, which continues now, is to provide technical guidance for Structure's field engineers analyzing designs of trenching & shoring systems used in the California Highway Construction program. Beginning with the initial edition of 1977, this Manual was well received by both the Department and the construction industry, and was distributed nationwide as well as to many foreign countries.

This 2011 Manual edition remains to be devoted to the analysis of trench and excavation earth support (shoring) systems needed for the construction of the Department's infrastructure. Its main objectives are to inform the Engineer of California's legal requirements, and to provide updated technical guidance for analysis and review. The Engineer should bear in mind that this Manual is a book of reference and instruction to be used with respect to the administration and engineering of excavation shoring. In cases of conflict, the contract documents shall prevail.

This edition includes significant procedural analysis improvements that have been developed since the previous major update of 1990. These enhancements were possible through significant contribution from Anoosh Shamsabadi PhD, PE. His work and those of Kenneth J Burkle, PE represent thousands of hours of effort for this Manual and for the current Caltrans Trenching and Shoring Check Program.

Current concepts in soil mechanics or geotechnical engineering are summarized in order to better acquaint the reader with the practical considerations and accepted application of theoretical principles. Some situations or conditions that may cause difficulty are noted. This 2011 Edition has reorganized and consolidated some Chapters of the previous Manual. A significant change is the chapter on Earth Pressure Theory, which was developed around AASHTO and Transportation Research Board (TRB Report 611) equations. The new AASHTO simplified procedures now provides the ability to address conditions with multiple soil layers, both granular and cohesive.

The first two chapters are devoted to the legal requirements and the responsibilities of the various parties involved. Not only must construction personnel be aware of the various legal requirements, they must thoroughly understand the implications excavations pose to work site safety.

The engineering objective of a shoring system is to be both safe and practical. There are two major parts of the engineering effort. First is the classification of the soil to be supported, determination

of strength, calculation of lateral loads, and distribution of lateral pressures. This is the soil mechanics or geotechnical engineering effort. The second is the structural design or analysis of members comprising the shoring system. The first part, the practical application of soil mechanics, is the more difficult. The behavior and interaction of soils with earth support systems is a complex and often controversial subject. Books, papers, and "Experts" do not always concur even on basic theory or assumptions. Consequently, there are no absolute answers or exact numerical solutions. A flexible, yet conservative approach is justified. This Manual presents a procedure that will be adequate for most situations. The Engineer must recognize situations that affect the use of the procedures discussed in the Manual and utilize sound engineering judgment as to which methods are appropriate.

There are many texts and publications of value other than those listed in the list of references. Use them; however, be cautious with older material. There are other satisfactory methods of approaching the engineering problem. This subject is recognized as an engineering art. The need for good judgment cannot be over emphasized. Do not lose sight of the primary objective: a safe and practical means of doing the work.

There are two major reasons why the Department considers shoring and earth retaining systems a subject apart from other temporary works such as falsework. First, an accident in a trench or excavation is more likely to have a greater potential for the maximum penalty, that is, the death of a workman. Cave-ins or shoring failures can happen suddenly, with little or no warning and with little opportunity for workers to take evasive action. Second, earth support systems design involves the complex interaction of soil types plus engineering factors that are often controversial and highly empirical.

Trenching or shoring is generally considered temporary work. Temporary work can mean 90 days for complicated structures, but it can also be understood to mean only several days for the majority of the trenching work done. The term "temporary" can be adversely affected by weather, material delays, change order work, strikes and labor disputes, and even subcontractor insolvency.

In preparing this Manual, it has been the Department's goal to cover as completely as practical some temporary earth retaining structures or systems. This Manual is the result of blending the Offices of Structure Construction (OSC) experience with continued research and study by

PREFACE

engineering staff from the Division of Engineering Services (DES). This Manual represents hundreds of years of experience compiled through a statewide team as noted below.

It would be impossible to acknowledge each and every individual who contributed to the development of the Manual. However, recognition is due to the major contributors as follows:

Author

Anoosh Shamsabadi, PhD, PE, Senior Bridge Engineer: DES Office of Earthquake Engineering

Editor

Kenneth J Burkle, PE, Senior Bridge Engineer

Winter Training 2010 Instruction Team

Steven Yee, PE, Senior Bridge Engineer	Margaret Perez, PE
Robert Price, PE, Senior Engineering Geologist	Anthony R English, PE
Anoosh Shamsabadi, PhD, PE, Senior Bridge Engineer	

Offices of Structure Construction Earth Retaining Technical Team (ERTT)

Jeff Abercrombie, PE, Supervising Bridge Engineer: ERTT Sponsor
Senior Bridge Engineers

Alex Angha, MS, PE	Steve Harvey, PE
OSC Structure Representatives	
Ann Meyer, PE	Victor N Diaz, PE
Ravinder S Gill, PE	David W Clark, PE

Offices of Structure Construction Headquarters Staff

John Babcock, PE, Supervising Bridge Engineer
Cheryl Poulin, PE, Senior Bridge Engineer
John J Drury, PE, Senior Bridge Engineer

Cartoons by, and included as a memoriam to, George W. Thomson, PE.

Additional Contributors:

Craig Hannenian, PE, Senior Transportation Engineer: DES Geotechnical Services
Kathryn Griswell, PE, Senior Bridge Engineer: Earth Retaining Systems Specialist, DES Office of Design & Technical Services

Selected Sections from:

Guidelines for Temporary Shoring, Published October 25, 2004, BNSF/UPRR (GTS)
Construction Safety Order from California Code of Regulations (CCR), Title 8, Sections 1504, 1539, 1540, 1541, 1541.1 (including appendices A - F), and Sections 1542 and 1543
Manual for Railway Engineering, 2002 American Railway Engineering and Maintenance-of-Way Association (AREMA)

CHAPTER 1

LEGAL REQUIREMENTS



LEGAL RESPONSIBILITIES

1.0 LEGAL REQUIREMENTS AND RESPONSIBILITIES

The State of California provides for the planning and design of permanent work to be prepared by the State (there are some exceptions with Design work prepared by a consultant), with the construction, including design of temporary work, to be performed by the Contractor.

This section of the Manual deals with the responsibilities of the Contractor and the State as related to trench and excavation work during the construction phase. Under Department of Transportation specifications, the Contractor is responsible for performing the work in accordance with the contract. This responsibility includes compliance with all State and Federal Laws, and applicable county or municipal ordinances and regulations, and the California Occupational Safety and Health Regulations, sometimes referred to as the Division of Occupational Safety and Health, (DOSH) but is better known as Cal/OSHA. These safety regulations are contained within the larger California Code of Regulations, Title 8 Industrial Relations (CCR Title 8). This Manual will refer to CCR Title 8 when referencing General Safety Regulations, while some references to the more specific subset of Construction Safety Orders will be noted as such. The hierarchy of the California Code of Regulations is as follows:

California Code of Regulations (CCR)

Title 1. General Provisions

...

Title 8. Industrial Relations

Division 1. Department Of Industrial Relations

Division of Occupational Safety and Health (Cal/OSHA)

Chapter 1

...

Chapter 3.2. California Occupational Safety And Health Regulations

Subchapter 2. Regulations of the Division of Occupational Safety and Health (Sections 340 - 344.85)

Chapter 4. Division of Industrial Safety

Subchapter 4. Construction Safety Orders (Sections 1500 - 1938)

Article 6. Excavations

CT TRENCHING AND SHORING MANUAL

The 2006 Standard Specification contains references to the protection of workmen and public in trench and excavation operations. Of particular interest is Section 5-1.02A. "Excavation Safety Plans":

The Construction Safety Orders of the Division of Occupational Safety and Health shall apply to all excavations. For all excavations 5 feet or more in depth, the Contractor shall submit to the Engineer a detailed plan showing the design and details of the protective systems to be provided for worker protection from the hazard of caving ground during excavation. The detailed plan shall include any tabulated data and any design calculations used in the preparation of the plan. Excavation shall not begin until the detailed plan has been reviewed and approved by the Engineer

Detailed plans of protective systems for which the Construction Safety Orders require design by a Registered Professional Engineer shall be prepared and signed by an engineer who is registered as a Civil Engineer in the State of California, and shall include the soil classification, soil properties, soil design calculations that demonstrate adequate stability of the protective system, and any other design calculations used in the preparation of the plan.

No plan shall allow the use of a protective system less effective than that required by the Construction Safety Orders.

If the detailed plan includes designs of protective systems developed only from the allowable configurations and slopes, or Appendices, contained in the Construction Safety Orders, the plan shall be submitted at least 5 days before the Contractor intends to begin excavation. If the detailed plan includes designs of protective systems developed from tabulated data, or designs for which design by a Registered Professional Engineer is required, the plan shall be submitted at least 3 weeks before the Contractor intends to begin excavation.

Attention is directed to Section 7-1.01E, "Trench Safety."

Standard Specification Section 7-1.01E "Trench Safety" reads:

Attention is directed to the requirements in Section 6705 of the Labor Code concerning trench excavation safety plans.

LEGAL RESPONSIBILITIES

Under Section 5-1.01 of the Standard Specifications it states, “the Engineer shall decide on questions that may arise as to the quality or acceptability of materials furnished and work performed...” However, it is the Contractor's responsibility to properly evaluate the quality of materials.

The State has the responsibility for administrating the contract. This means that interpretation of contract requirements, including acceptance of materials, is done by the State, not any other agency such as Cal/OSHA. Although the work must be performed in compliance with the CCR, Title 8, there may be situations or conditions where they are not applicable or adequate. Under these circumstances the Engineer makes an interpretation and informs the Contractor accordingly of what is required.

The documents that apply to a contract are as follows:

- Department of Transportation Standard Specifications
- Standard Plans
- Project plans
- Project Special Provisions
- Contract change orders
- California Code of Regulations, Title 8 (CCR, Title 8)
- California Streets And Highways Code
- California Labor Code (The Law).
- All existing and future State and Federal laws, and county and municipal ordinances and regulations of other governmental bodies or agencies, such as railroads having jurisdiction within the project.

1.1 LABOR CODE

The California Labor Code is the document of enacted law to which all employers and employees must conform.

Division 5 'Safety in Employment' was enacted by Statute 1937 with changes in 1973, 1977, and 1979. Sections 6300 to 6707 pertain to the subject of trenching and shoring.

Section 6300 establishes that the California Occupational Safety and Health Act of 1973 is enacted law. This authorizes the enforcement of effective standards for safety at work sites.

Section 6307 gives Cal/OSHA the power, jurisdiction, and supervision over every place of employment to enforce and administer California Code of Regulations (CCR), Title 8, under which the Safety Orders reside.

Section 6407, states that, "Every employer and every employee shall comply with occupational safety and health standards, with Section 25910 of the Health and Safety Code, and with all rules, regulations and orders pursuant to this division which are applicable to his own actions and conduct (Statute 1977 Ch. 62)".

Section 6705 establishes that for public work projects involving an estimated expenditure in excess of \$25,000 for the excavation of any trench or trenches, five feet or more in depth, the Contractor must submit shoring plans to the awarding body.

Section 6706 pertains to the permit requirements for trench or excavation construction.

The California Code of Regulations can be viewed at the following website:

<http://www.leginfo.ca.gov/calaw.html>

The CCR Title 8 Industrial Relations can be viewed at the following website:

<http://www.dir.ca.gov/counters/t8index.htm>

And from this page you can find the Cal/OSHA and all the Safety Orders

1.2 Cal/OSHA

Cal/OSHA enforces the California Code of Regulations, Title 8 safety regulations in every place of employment by means of inspections and investigations. Citations are issued for violations and penalties may be assessed. In the event of an "imminent hazard", entry to the area in violation is prohibited.

Cal/OSHA may perform the following activities:

- Preparation of construction safety orders
- Policing of conformance with safety orders
- Investigation of accidents
- Compilation of Safety Statistics
- Conduct Safety Training
- Publication of Safety Order Changes

LEGAL RESPONSIBILITIES

- Publication of Safety, Information (Training & Education Brochures)
- Consultation Service
- Assessment and review of citations

There are numerous geographical Cal/OSHA offices within the state. Refer to Appendix A of this Manual or go to <http://www.dir.ca.gov/dosh/DistrictOffices.htm> for a web listing of the Cal/OSHA offices.

Compliance with CCR, Title 8 is not the same as conducting a "safety program" for employees. The objective of accident-free work is the same, but the means of implementation are quite different. Every employer in California is required by law (Labor Code Section) to provide a safe and healthful workplace for his/her employees. Title 8, of the California Code of Regulations (CCR), requires every California employer to have an effective Injury and Illness Prevention Program in writing that must be in accord with CCR, Title 8, General Industry Safety Orders, Section 3203 "Injury and Illness Prevention Program" and the requirements in CCR, Title 8, Construction Safety Orders, Section 1509 "Injury and Illness Prevention Program." Effective safety programs rely on the inspection for compliance with the Construction Safety Orders, but includes education and training activities and taking positive actions in regard to conduct of the work.

Cal/OSHA will not perform engineering or inspection work for the Contractor or Caltrans. The Cal/OSHA activity is essentially a policing operation in regard to ascertaining compliance with the CCR, Title 8 safety regulation.

The CCR, Title 8, Construction Safety Orders establish minimum safety standards whenever employment exists in connection with the construction, alteration, painting, repairing, construction maintenance, renovation, removal, or wrecking of any fixed structure or its parts. They also apply to all excavations not covered by other safety orders for a specific industry or operation. At construction projects, the Construction Safety Orders take precedence over any other general orders that are inconsistent with them, except for Tunnel Safety Orders or Compressed Air Safety Orders.

The introduction to the Construction Safety Orders states that no employer shall occupy or maintain any place of employment that is not safe. Construction Safety Orders Section 1541 extends this protection directing that no work in or adjacent to an excavation will be performed

until conditions have been examined and found to be safe by a competent person, and also that all excavation work shall have daily and other periodic inspections.

A permit is required by Cal/OSHA prior to the start of any excavation work for any trench 5 feet or deeper in to which a person is required to descend, per CCR Title 8, Chapter 3.2, Subchapter 2, Article 2, Section 341, Subsection (d)(5)(A). Note that this reference is to safety regulations outside Chapter 4, Subchapter 4, Construction Safety Orders. The employer shall hold either an Annual or a Project Permit. Note: For purposes of this subsection, "descend" means to enter any part of the trench or excavation once the excavation has attained a depth of 5 feet or more. There are some exceptions, such as work performed by State forces on State R/W, and forces of utilities which are under the jurisdiction of the Public Utilities Commission. Railroads are included in the foregoing group.

It should be noted that a Cal/OSHA permit is not an approval of any shoring plan. The Contractor makes application to Cal/OSHA to procure an excavation permit. This application will describe the work, its location, and when it is to be performed. Cal/OSHA may request that the Contractor furnish more details for unusual work, perhaps even a set of plans. These plans are not necessarily the detailed plans that are submitted to the Engineer for review and approval.

The objective of a Cal/OSHA Permit is to put Cal/OSHA on notice that potentially hazardous work is scheduled at a specific location. Cal/OSHA may then arrange to inspect the work.

Cal/OSHA issues permits for various conditions. A single permit can cover work of a similar nature on different contracts. It can be for a specific type of work within a Cal/OSHA regional area. In this case, the permit will have a time limit and the user is obligated to inform the appropriate Cal/OSHA office of his schedule for work covered by the permit. A copy of the permit is to be posted at the work site. It is the responsibility of the Engineer to ascertain that the Contractor has secured a proper permit before permitting any trenching or excavation work to begin.

Section 1540 of the Construction Safety Orders (Chapter 4, Subchapter 4 of the CCR, Title 8) defines a Trench (Trench excavation) as:

A narrow excavation (in relation to its length) made below the surface of the ground. In general, the depth is greater than the width, but the width of a trench (measured at the

LEGAL RESPONSIBILITIES

bottom) is not greater than 15 feet. If forms or other structures are installed or constructed in an excavation so as to reduce the dimension measured from the forms or structure to the side of the excavation to 15 feet or less, (measured at the bottom of the excavation), the excavation is also considered to be a trench.

Excavations, which are more than 15 feet wide at the bottom, or shafts, tunnels, and mines, are excavations by Cal/OSHA definition. However, this does not mean that an excavation permit and shoring plans are not required. Box culvert and bridge foundations are examples. Bridge abutments will present a trench condition at the time that vertical rebar or back wall form panels are erected. The solution is to either provide a shoring system to retain the earth, or cut the slope back at an acceptable angle.

1.3 STATE STATUTES

California Streets and Highways Code Section 137.6 of Article 3 in Chapter 1 of Division 1 of the Statutes, requires that the review and approval of Contractor's plans for temporary structures in connection with the construction of State Highways shall be done by a Registered Professional Engineer.

"137.6. The design of, the drafting of specifications for, and the inspection and approval of state highway structures shall be by civil engineers licensed pursuant to the Professional Engineers Act (Chapter 7 (commencing with Section 6700), Division 3, Business and Professions Code)."

"The approval of plans for, and the inspection and approval of, temporary structures erected by contractors in connection with the construction of state highway structures shall also be by such licensed civil engineers."

This means that the Engineer has the responsibility to see that appropriate plans are submitted and properly reviewed for work to be performed within State right of way.

1.4 FEDERAL HIGHWAY ADMINISTRATION (FHWA)

Section 7 of the Amended Standard Specifications contains the Federal requirements for the project. These include provisions for safety and accident prevention. The Contractor is required to comply with all applicable Federal, State, and local laws governing safety, health, and sanitation. Conformance with current Cal/OSHA standards will satisfy Federal Requirements, including Fed/OSHA.

1.5 RAILROAD RELATIONS AND REQUIREMENTS

Contract Special Provisions, Section 13, for the project will contain the railroad agreement with the State. These provisions require that the Contractor shall cooperate with the railroad where work is over, under, or adjacent to tracks, or within railroad property, and that all rules and regulations of the railroad concerned shall be complied with. It also requires that the Contractor and subcontractors have approved Railroad Insurance and submit plans for all temporary works on railroad property to the railroad for review and approval.

The Department of Transportation has established an administrative procedure for handling shoring plans that involve railroads as follows:

- Contractor submits shoring plans to the Engineer (Project Resident Engineer). Railroads require that a plan be prepared even if proposed system is in accordance with Cal/OSHA Details. Shoring is required for excavations less than 5 feet in depth if specific railroad criteria calls for it (railroads differ in requirements). The drawing must include a trench cross-section and a plan view giving minimum clearances relative to railroad tracks. Provisions for walkways, if required, are to be submitted with the plans. Plans are to be prepared by a California Registered Professional Engineer with each sheet of the plans signed.
- Some railroads have their own specifications for shoring. The railroad specifications will be used in conjunction with DOT Policy and the Cal/OSHA Construction Safety Orders. The most restrictive of these will apply. The reader is referred to CHAPTER 8 of this Manual for railroad requirements.
- The Engineer reviews the plan for completeness. Once satisfied the Contractor's design meets all the requirements and is structurally adequate, the Engineer will forward the plan with the Contractor's and the Engineer's calculations to the Offices of Structure Construction Headquarters in Sacramento (OSC HQ).
- In Sacramento, OSC HQ will make a supplementary review. Then if the plans and calculations are satisfactory they will be forwarded to the railroad concerned.
- The railroad reviews and approves the shoring plans, and notifies OSC HQ in Sacramento of an approval or a rejection.

LEGAL RESPONSIBILITIES

- OSC HQ notifies the Engineer of the result of railroad's review.
- Shoring plans that are rejected are returned to the Contractor for resubmittal after corrections are made addressing all railroad comments.
- The Engineer approves the plans and notifies the Contractor only upon receiving OSC HQ notice of the railroads approval.

Section 19-1.02, "Preservation of Property" of the Standard Specifications for Earthwork includes a provision stipulating that detailed shoring plans of the protective systems for excavations on or affecting railroad property be submitted at least 9 weeks before the Contractor intends to begin any excavation requiring protective shoring.

Note that the railroad deals directly with the Sacramento Office of OSC, not with the Engineer on the job site. Adequate time should be allowed for the review procedure. The railroad may take up to 6 weeks for review from the time that they receive the plans from Sacramento. The proper time to alert the Contractor to procedure and time needed is at the pre-job conference.

The OSC Structure Representative on the project will handle the review and approval of shoring plans that involve railroads. However, when there is no OSC representative, the District should request technical assistance from the Offices of Structure Construction by contacting the Area Construction Manager, or from the Offices of Structure Construction Headquarters in Sacramento.

1.6 SHORING PLANS

Section 5-1.02A of the Standard Specifications requires that a Contractor submit a shoring plan for any excavation 5 feet or deeper to the Engineer for his review and approval. Such plans are to be submitted in a timely manner as specified in Section 5-1.02A of the Standard Specifications (or as required by the contract Special Provisions) before the Contractor intends to begin excavating. No work shall begin until the shoring plans are approved by the Engineer.

If the Contractor elects to use the Construction Safety Orders Details, it is not required that a Professional Engineer prepare the plan. However, a shoring plan is still required. This plan can be a letter to the Engineer containing the information outlined in Section 2.0 "Shoring Plan Submittal," in CHAPTER 2 of this Manual.

The Details in the Construction Safety Orders consist of sloping, or tables of minimum member sizes for timber and aluminum hydraulic shoring with member spacings related to the three general types of soil, along with various restrictions on use of materials and construction methods.

The Engineer is cautioned that conditions may be such that the Construction Safety Order Details will not apply: for example when a surcharge load exceeds the minimum construction surcharge of 72 psf. In such a case, an 'engineered' system is required. The proposed plan must provide a system at least as effective as the Construction Safety Orders Details, and the plan must be prepared and signed by a California Registered Professional Engineer. The contractor's engineered plan would include the following items in addition to the information listed for Construction Safety Order Details:

- An engineering drawing showing sizes, spacing, connections, etc. of materials.
- Appropriate additional soils data.
 - A Geotechnical Engineer or a Civil Engineer specializing in soils shall prepare soils reports and supplemental data.
- Supporting data such as design calculations or material tests.

The Engineer will make a structural review of any plan that deviates from the Construction Safety Orders Details.

In general practice, engineered drawings will be accompanied by an engineer's calculations. If railroads are involved, a minimum of three sets of calculations and seven sets of plans should be submitted. The railroads require a minimum of one set of calculations each from the designer and reviewer and four sets of shoring plans. The Engineer retains one set of calculations and two sets of plans. One additional complete set of calculations and drawings will be needed for the HQ OSC Sacramento Office.

1.7 SUMMARY

This Manual contains a presentation of much of the technical engineering information that can be used by the Engineer in making a review of shoring plans.

The design or engineering analysis, of a shoring system is accomplished in the following sequence:

- The soil or earth that is to be retained and its engineering properties are determined.
- Soil properties are then used in geotechnical mechanics or procedures to determine the earth pressure force acting on the shoring system.
- The design lateral force is then distributed, in the form of a pressure diagram. The distribution, or shape, of the diagram is a function of type of shoring system and the soil interaction with the system.
- Lateral loads due to surcharges and from sources other than basic soil pressure (e.g. ground water) are determined and combined with the basic soil pressure diagram. The resulting lateral pressures become the design lateral pressure diagram.
- The design lateral pressure diagram is applied to the system, and a structural analysis is made. Again, there is a range from simplified to refined or complex procedures that can be used.

Keep in mind a proper balance of engineering effort. If soils data is not detailed or is not available, it is not proper to use complex or sophisticated analyses. With good soils data it is satisfactory to first use simplified analysis procedures, which lead to a conservative check; then if the system appears inadequate, use a more refined procedure.

The engineering analysis is a progressive procedure dependent upon complexity or sophistication. It is a function of the size of the project or how unusual or unique it is. A simplified analysis procedure can be used for the majority of trench and shoring projects. For complex systems, the Engineer may be presented with methods that are not discussed in this Manual. The Engineer should be prepared to do some research. A procedure should not be rejected simply because it is not covered in this Manual. This Manual presents basic engineering procedures. Additional design information or copies of text material needed to analyze the calculations should be requested. The

CT TRENCHING AND SHORING MANUAL

Geotechnical Services of the Division of Engineering Services (DES) is available for consultation for major problems.

It is recognized that the construction phase is of equal importance. Construction activities include workmanship, inspection, and taking appropriate timely action with regard to changing conditions. The reader is referred to CHAPTER 9, Construction and Special Considerations, for more information.

When shoring plans are being reviewed, the following procedure is recommended. Perform an initial review of the shoring in conformance with the procedures in the Trenching and Shoring Manual. As with any set of plans or working drawings, if the submitted material is incomplete, the Contractor should be notified immediately. It will be necessary for the Contractor to submit all additional information needed to perform a review, for example, a more thorough description of design procedures, assumptions, and additional calculations. If the review indicates discrepancies in the design, it will be necessary to review the criteria used by the designer. Note, however, there is no requirement that the design must be in conformance with the criteria outlined in this Manual. It may be necessary for the Contractor to also submit copies of the confirming design theory and computations. In case of a dispute, contact the Offices of Structure Construction HQ in Sacramento.

CHAPTER 2

Ca/OSHA

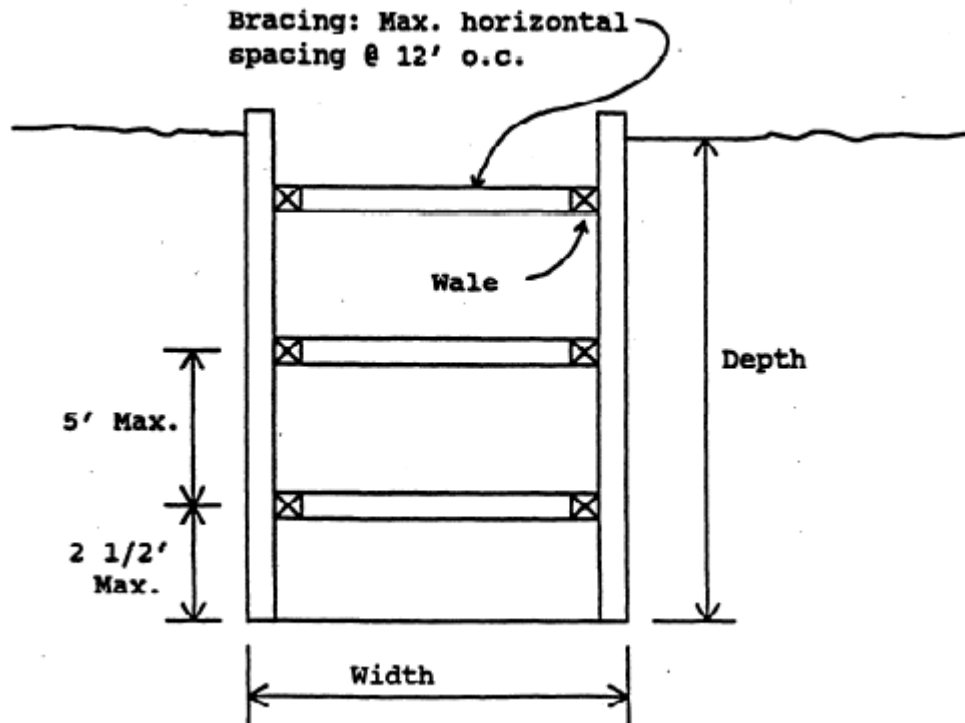

2.0 Cal/OSHA

The California Division of Occupations Safety and Health, better known as Cal/OSHA, reports that more construction deaths occur in trenches than in any other form of construction work. This is despite a number of trench and excavation failures that go unreported. It is evident from this that a continued diligence must be given to the planning, construction, monitoring, and supervisory aspects of excavations and trenching.

The information in this chapter and in Appendix A of this Manual is current as of January 2010. It will be the responsibility of the reader to determine up-to-date applicable requirements.

Cal/OSHA adopted the Federal OSHA safety regulations pertaining to protection of workmen in excavations, effective September 25, 1991. These are embodied in the California Code of Regulations, Title 8 (CCR, Title 8).

This chapter contains outlines of major portions of the adopted safety regulations that pertain to safety in conjunction with excavations. Major considerations, or requirements of the safety regulations, in numerical order of the Sections, are briefly outlined on the following pages. Following the brief outlining is a condensed outline of most of the Cal/OSHA Safety Orders pertaining to the subject of excavations. The text of most Cal/OSHA excavation requirements may be found in Appendix A of this Manual. Appendix A text includes Construction Safety Order from CCR, Title 8, Sections 1504, 1539, 1540, 1541, 1541.1 (including appendices A - F), and Sections 1542 and 1543.

Excavations 20' Deep Or Less: Construction Safety Orders Section 1504 and Sections 1539 through 1543 contain the excavation and shoring requirements. These sections provide for a variety of excavation plans for workman protection in excavations. For excavations less than 20 feet in depth the Contractor may use sloping or benching of the soil, tables for timber or aluminum hydraulic shoring, shields, or the shoring may be designed by a California Registered Professional Engineer.

Excavations Over 20' Deep - Deviations: A California Registered Professional Engineer is required to design a protective system for excavations greater than 20 feet in depth, when there are:

- deviations from the sloping criteria

CT TRENCHING AND SHORING MANUAL

- deviations not covered in the Safety Orders from the timber or aluminum hydraulic shoring tables
- shields to be used in a manner not recommended or approved by the manufacturer
- surcharges that must be accounted for
- alternate designs used

The designing engineer may base his design on manufacturer's information, on a variety of tables and charts, use of proprietary systems, on soils information furnished by a competent person, and in accordance with accepted professional engineering practice.

Maintain Design Plan At The Jobsite: Construction Safety Orders Section 1541.1 (b) (3) (B) 4 require that at least one copy of the tabulated data, manufacturer's data or engineer's design is to be maintained at the jobsite during construction of the protective system and that the identity of the Registered Professional Engineer approving tabulated or manufacturer's data be included in the information maintained at the jobsite. The Registered Professional Engineer approving the data refers to the engineer responsible for the design of the protective system.

Registered Professional Engineer: For work in California the design engineer must be a Registered Professional Engineer in California pursuant to California Streets and Highways Code Section 137.6.

Competent Person: The Construction Safety Orders in Section 1504 defines a competent person as, "One who is capable of identifying existing and predictable hazards in the surroundings or working conditions which are unsanitary, hazardous, or dangerous to employees, and who has authorization to take prompt corrective measures to eliminate them."

Surcharges: The Figures and Tables in the Appendices of Section 1541.1 of the Construction Safety Orders provide for a minimum surcharge equivalent to an additional soil height of 2 feet. The minimum surcharge may be considered to represent a 2 feet high soil embankment, small equipment, material storage, or other small loadings adjacent to the excavation. No provision is made for nearby traffic, adjacent structure loadings, or for dynamic loadings. (See, Section 1541.1 Appendix C)

Shoring Plan Submittal: The Contractor may submit a shoring plan using Construction Safety Orders Details for sloping excavations or tabular data, in the form of a letter stating which portions of the Details are to apply to the plan. The letter should list:

- location of the work
- limits of the work
- the times the work is to start and be in progress and sequence
- the applicable Construction Safety Orders Detail Figures or Tables
- any other information which will pertain to the progress or complexity of the work
- who will be in charge of the work
- who will be the designated competent person responsible for safety

If the Contractor elects to use the shoring details in the Construction Safety Orders, it is not necessary to have the shoring plan prepared by a registered engineer; and the reviewing engineer does not have to do a structural analysis. However, the reviewing engineer must ascertain that the Contractor does the work in accordance with the Construction Safety Orders and that the site conditions are such that the shoring plan is appropriate for the soil conditions encountered.

2.1 SOME IMPORTANT CalIOSHA DEFINITIONS

Describing or citing primary sections can condense a lot of information about the requirements in the Construction Safety Orders. A few important definitions are included here, but the reader is directed to a more complete text of the CCR, Title 8 and Construction Safety Orders included in Appendix A of this Manual.

From Section 1504, "Excavation, Trenches, Earthwork,"

Geotechnical Specialist (GTS): "A person registered by the State as a Certified Engineering Geologist, or a Registered Civil Engineer trained in soil mechanics, or an engineering geologist or civil engineer with a minimum of 3 years applicable experience working under the direct supervision of either a Certified Engineering Geologist or Registered Civil Engineer".

From Section 1540, "Excavations,"

Accepted Engineering Practices: Those requirements, which are compatible with standards of practice required by a Registered Professional Engineer.

Excavation: All excavations made in the earth's surface. Any manmade cut, cavity, trench, or depression in an earth surface, formed by earth removal. Excavations are defined to include trenches.

Protective System: A method of protecting employees from cave-ins, from material that could fall or roll from an excavation face or into an excavation, or from collapse of adjacent structures. Protective systems include support systems, sloping and benching systems, shield systems, and other systems that provide the necessary protection.

Registered Professional Engineer: A person who is registered as a Professional Engineer in the state where the work is to be performed. However, a professional engineer, registered in any state is deemed to be a "Registered Professional Engineer" within the meaning of this standard when approving designs for "manufactured protective systems" or "tabulated data" to be used in interstate commerce. (The interstate commerce provision affords relief for utilities when crossing State boundaries).

Shield (Shield System): A structure that is able to withstand the forces imposed on it by a cave-in and thereby protect employees within the structure. Shields can be permanent structures or can be designed to be portable and moved along as work progresses. Additionally, shields can be either premanufactured or job-built in accordance with Section 1541.1(c)(3) or (c)(4). Shields used in trenches are usually referred to as "trench boxes" or "trench shields."

Sloping (Sloping System): A method of protecting employees from cave-ins by excavating to form sides of an excavation that are inclined away from the excavation so as to prevent cave-ins. The angle of incline required to prevent a cave-in varies with differences in such factors as the soil type, environmental conditions of exposure, and application of surcharge loads.

Shoring (Shoring System): A structure such as a metal hydraulic, mechanical, or timber shoring system that supports the side of an excavation and which is designed to prevent cave-ins.

Tabulated Data: Tables and charts approved by Registered Professional Engineer and used to design and construct a protective system.

Trench: A narrow excavation (in relation to its length) made below the surface of the ground. In general, the depth is greater than the width, but the width of a trench (measured at the bottom) is not greater than 15 feet. If forms or other structures are installed or constructed in an excavation so as to reduce the dimension measured from the forms or structure to the side of the excavation to 15 feet or less, (measured at the bottom of the excavation), the excavation is also considered to be a trench.

2.2 SOME IMPORTANT Cal/OSHA REQUIREMENTS

A few of the important considerations from the Construction Safety Orders portion of the CCR, Title 8 are listed here for easy reference. The complete text of Section 1541 referred to below is included in Appendix A of this Manual.

2.2.1 General Requirements Section 1541

Underground utilities must be located prior to excavation. The Contractor should notify Underground Alert or other appropriate Regional Notification Centers a minimum of 2 working days prior to start of work. Excavation in the vicinity of underground utilities must be undertaken in a careful manner while supporting and protecting the utilities.

Egress provisions, which may include ladders, ramps, stairways, or other means, shall be provided for excavations over 4 feet in depth so that no more than 25 feet of lateral travel will be needed to exit trench excavations.

Adequate protection from hazardous atmospheres must be provided. This includes testing and controls, in addition to the requirements set forth in the Construction Safety Orders and the General Industry Safety Orders to prevent exposure to harmful levels of atmospheric contaminants and to assure acceptable atmospheric conditions.

Employees shall be protected from the hazards of accumulating water, from loose or falling debris, or from potentially unstable adjacent structures.

Daily inspections, inspections after rain storms and as otherwise required for hazardous conditions, are to be made by a competent person. Inspections must be conducted prior to the start of work and as needed throughout the shift. The competent person will need to check for potential cave-ins, indications of failure of the protective system, and for hazardous atmospheres. When the competent person finds a hazardous situation he shall

have the endangered employees removed from the area until the necessary precautions have been made to ensure their safety.

Adequate barrier physical protection is to be provided at all excavations. This is extremely important at remotely located locations, where active construction operations are absent. All wells, pits, shafts, etc., shall be barricaded or covered. Upon completion of exploration and other similar operations, temporary shafts etc., shall be backfilled.

2.2.2 Protective System Selection

Section 1541.1 of the Construction Safety Orders covers almost all of the requirements that must be considered in selecting or reviewing a particular type of shoring system. The text of this section contains general information and considerations about the various selections, which may be made for shoring systems. This section describes the various shoring systems, which can be used with and without the services of a Registered Professional Engineer. Additional information about the various shoring systems may be found in Appendix A through Appendix F of Section 1541.1 (See Appendix A of this Manual).

The Contractor may use this portion of the Cal/OSHA, Construction Safety Orders to select a particular type of shoring system best suited to fit the soil conditions and the jobsite situation. The services of a Registered Professional Engineer are not necessarily required for the shoring options available to the Contractor in these Construction Safety Orders Details provided they are used within the limitations of the Details.

An overview of the major portions of Section 1541.1 is outlined below. The complete text of Cal/OSHA, Construction Safety Order Section 1541.1 is included in Appendix A of this Manual.

The design of a protective system for workmen in an excavation may be selected from one of the possible options listed below:

Stable rock - No shoring needed.

Excavation less than 5 feet deep - No shoring needed.

Sloping or benching:

- Slope 1 1/2 : 1 as for Type C soil.
Steeper slopes may be used for short term (1 day).
- Slope using Table B-1 or Figure B-1 of Appendix B.
Slopes dependent on soil type - see Appendix A.
- Per tables or charts identified by a California Registered Professional Engineer.
- Design by a California Registered Professional Engineer.

Design of support systems, shield, or other systems:

- Design in accordance with Appendix A, or C - F.
Appendix A - Soil classification.
Appendix C - Timber shoring tables.
Appendix D - Hydraulic shoring tables.
Appendix E - Alternatives to timber shoring.
Appendix F - Flow chart guides to system selection.
- Design using Manufacturer's data (shields for example)
Data includes specifications, limitations, and/or other tabulated data
(Tables or Charts).
- Design using other tabulated data (Tables or Charts),
Identified by a California Registered Professional Engineer approving
the data. [Approving engineer implies the California Professional
Engineer designing or submitting the shoring plan.]
- Design by a Registered Professional Engineer.
Identified by a California Registered Professional Engineer approving
the plan. [Approving engineer implies the California Professional
Engineer designing or submitting the shoring plan.]

Shoring system designs (including manufacturer's data) other than those selected directly from tables in Appendix A - F will need to be posted at the jobsite during construction of the protective system.

Damaged materials or equipment will need to be reevaluated for use by a competent person or by a Registered Professional Engineer before being put back into use.

Individual members of support systems may not be subjected to loads exceeding those which they are designed to withstand.

Excavation of material to a level no greater than 2 feet below the bottom of the members of a support system shall be permitted, but only if the system is designed to resist the forces calculated for the full depth of the excavation, and no loss of soil is possible.

Shields systems are not to be subjected to loads exceeding those which the system was designed to withstand.

2.2.3 Soil Classification

APPENDIX A TO SECTION 1541.1

Appendix A to Construction Safety Order Section 1541.1 contains the soil classification information that may be used for the proper selection of a shoring system. (See Appendix A of this Manual.) This section describes when soil classification information may be used as well as defining soil and soil types (A, B, or C). The section also covers the basis of soil classification, who can classify soil and how soil classification may be done by using visual or manual tests and through other various field testing methods.

A competent person, or a testing lab, may make determinations by at least one visual and at least one manual test to classify rock or soil for the proper selection, or for the design, of a shoring system. Classification of the soil is necessary to determine the effective active soil pressures that the shoring system may be subjected to. The tables for the selection of sloping, timber shoring, or aluminum hydraulic shoring, are based on one of three types of soil (A, B, or C).

The three soil types in the Construction Safety Orders are described below:

Type A: Cohesive soil with unconfined compressive strength of 1.5 tsf or greater.

Examples of this soil type are: clay, silty clay, sandy clay, clay loam, silty clay loam, sandy clay loam, cemented soils like caliche or hardpan.

No soil-is Type A if:

- The soil is fissured.
- Vibratory or dynamic loads will be present.
- The soil has been previously disturbed.
- Sloped (4H:1V or greater) layers dip into the excavation.
- Other factors preclude Type A classification.

Type B: Cohesive soil with unconfined compressive strength greater than 0.5 tsf but less than 1.5 tsf or:

Granular cohesionless soils including: angular gravel, silt, silty loam, sandy loam, or maybe silty clay loam and sandy clay loam, or:

Previously disturbed soils not classified as Type C or:

Soil that meets the requirements of type A but is fissured or subject to vibration, or:

Dry rock that is not stable, or:

Type B soil that has sloped (4H:1V or less.) layers that dip towards the excavation.

Type C: Cohesive soil with unconfined compressive strength of 0.5 tsf or less or:

Granular soil including gravel, sand, and loamy sand, or:

Submerged soil, or from which water is freely seeping, or:

Submerged rock that is not stable, or:

Material sloped towards the excavation 4H:1V or steeper in a layered system.

Tables in the Construction Safety Orders for timber or for aluminum hydraulic shoring consider the effective lateral pressures for a depth H due to the three different soil types as follows:

Type A: $PA = 25H + 72\text{psf}$ (2 Ft. Surcharge)

Type B: $PA = 45H + 72\text{psf}$ (2 Ft. Surcharge)

Type C: $PA = 80H + 72\text{psf}$ (2 Ft. Surcharge)

Manual testing of soils includes tests for plasticity, tests for dry strength, thumb penetration, and the use of a pocket penetrometer or hand operated vane shear tester. Samples of soil can be dried to determine relative cohesive content. A few of these tests may be used to determine compressive strength; the other tests may be used to determine relative cohesive properties of the soil. The test procedures are outlined in the complete text of Appendix A to Section 1541.1 (See Appendix A of this Manual). Note that expansive clays are not mentioned and may need special consideration.

2.2.4 Sloping or Benching Systems

APPENDIX B TO SECTION 1541.1

Appendix B of Construction Safety Order Section 1541.1 contains specifications for sloping and benching options, including visual diagrams, for excavations less than 20 feet in depth. (See Appendix A of this Manual.) A Registered Professional Engineer may design alternate configurations. Slopes may be laid back in conformance with the figures in Appendix B to-Section 1541.1 providing there is no sign of distress and surcharge loads will not be a factor. Signs of distress include: caving-in-of the soil, development of fissures, subsidence, bulging or heaving at the bottom of the excavation, or spalling or raveling at the face of the excavation.

When there is a sign of distress, the slope shall be laid back at least 1/2 horizontal to 1 vertical less than the maximum allowable slope.

Allowable slopes shall be reduced as determined by a competent person when surcharge loads other than from adjacent structures are present.

When surcharge loads from structures are present, underpinning or bracing will be required, otherwise the structure must be on stable rock or a Registered Professional Engineer must determine that the excavation work will not pose a hazard to employees.

Table B-1 of Appendix B to Section 1541.1 lists the following maximum slopes for the various soil types:

Stable Rock:	Vertical
Type A:	¾:1
Type B:	1:1
Type C:	1½:1

Exceptions:

Type A soil:	½H:1V	Slope permitted for up to 12 feet in depth for short term duration (24 hours or less).
--------------	-------	--

A Registered Professional Engineer shall design excavations over 20 feet in depth.

Type A Soil Sloping and/or Benching Options:

¾:1 slopes.

½:1 slopes (Short term and 12 feet or less).

¾:1 slope with 4 foot high single bench at bottom.

¾:1 slope replaced with 4' high and 5' high benches.

¾:1 slope above 3½ foot high bench (8, max. depth).

1:1 slope above 3½ foot high bench (12, max. depth).

¾:1 slope above supported or shielded system.

A single or lower bench may be in front of the slope line, but all higher benches must be behind the slope line.

Type B Soil Sloping and/or Benching Actions:

1:1 slopes.

1:1 slopes above 4' high single bench.

1:1 slopes replaced with 4' high benches (Cohesive soil).

1:1 slopes above supported or shielded system.

A single or lower bench may be in front of the slope line, but all higher benches must be behind the slope line.

Type C Soil Sloping and/or Benching Options:

1½:1 slopes.

1½:1 slopes above supported or shielded system.

Layered Soils Sloping:

Type B over Type A: Slope Type B 1:1 and Type A ¾:1.

Type C over Type A: Slope Type C 1½:1 and Type A ¾:1.

Type C over Type B: Slope Type C 1½:1 and Type B 1:1.

Type A over Type B: Slope both 1:1.

Type A over Type C: Slope both 1½:1.

Type B over Type C: Slope both 1½:1.

2.2.5 Timber Shoring for Trenches

APPENDIX C TO SECTION 1541.1

Appendix C of Construction Safety Order Section 1541.1 contains information and tables that the Contractor may utilize to shore trenches less than 20 feet deep with rough or finish timbers in any of the three types of soil. (See Appendix A of this Manual) Tables C-1.1 through C-1.3 may be used for minimum rough (actual) size timbers having a minimum f_b of 850 psi, and Tables C-2.1 through C-2.3 are for finished (S4S) timbers having a minimum f_b of 1500 psi. There is one table for each soil type for each of the timber grading sizes.

Summaries of notes which are meant to accompany the tables are listed below:

- When conditions are saturated use tight sheeting (tight sheeting refers to 3 " rough tongue and groove timbers, steel sheet piling or similar to resist imposed lateral loads including water). Close spacing refers to placing planks side-by-side as close as possible.
- All spacings indicated are center to center.
- Wales are to be installed with greatest dimension horizontal.
- If the vertical distance from the center of the lowest cross brace to the bottom of the trench is to exceed 2.5 feet uprights are to be firmly imbedded, or a mudsill is to be used. A mudsill is a waler placed at the bottom of the trench.

Maximum distance from lower brace to bottom of trench:

36 inches for imbedded sheeting.

42 inches when mudsills are used.

- Trench jacks may be used in place of, or in combination with timber struts.
- Upper crossbrace (strut) vertical spacing from top of excavation is not to exceed one-half tabulated vertical crossbrace spacing.
- When any of the following conditions will exist the tables will not be adequate:
 - When loads imposed by structures of stored materials adjacent to the trench will exceed the load from a 2 foot surcharge. Adjacent means within a horizontal distance equal to the depth of the trench.
 - When vertical loads on the center of crossbraces exceed 240 pounds.
 - When surcharge loads from equipment weighing over 20,000 pounds are present.
 - When only the lower portion of a trench is shored and the remaining portion is sloped or benched unless:
 - The sloping portion is sloped less than 3H:1V, or
 - The shoring is selected for full depth excavation.

Appendix C to Section 1541.1 also contains four example problems demonstrating selection of shoring from the tables.

2.2.6 Aluminum Hydraulic Shoring for Trenches

APPENDIX D TO SECTION 1541.1

Appendix D of Construction Safety Order Section 1541.1 contains typical installation diagrams, tables, and information for the use of aluminum hydraulic shoring in trenches less than 20 feet deep. (See Appendix A of this Manual.) Tables D-1.1 and D-1.2 are for vertical shores in Type A and B soils. Tables D-1.3 and D-1.4 are for horizontal waler systems in Type B and Type C soils. Type B soils may require sheeting, whereas Type C soils always require sheeting.

The tables consider two cylinder sizes with minimum safe working capacities as follows: 2 inch inside diameter with 18,000 pounds axial compressive load at maximum extension, or 3 inch inside diameter with 30,000 pounds axial compressive load at extensions as recommended by the product manufacturer.

When any of the following conditions exist the tabular data will not be valid:

- When vertical loads exceeding 100 pounds will be imposed on the center of hydraulic cylinders.
- When surcharge loads are present from equipment weighing in excess of 20,000 pounds.
- When only the lower portion of the trench is shored and the upper portion is sloped or benched steeper than 3H:1V; unless the shoring is selected for a trench full depth from the upper hinge point to the bottom of the trench.

Footnotes for the aluminum hydraulic shoring will be found in Section (g) of Appendix D to Section 1541.1 immediately preceding the Figures (See Appendix A of this Manual).

Minimum thickness plywood of 1 1/8" (or 3/4" thick 14 ply Finply) may be used in conjunction with aluminum hydraulic shoring to prevent raveling, but may not be used as structural members.

Alternate designs and designs for excavations over 20 feet deep must be submitted by a California Registered Professional Engineer.

2.2.7 Shield Systems

APPENDIX E TO SECTION 1541.1

Appendix E of Construction Safety Order Section 1541.1 contains a few diagrams of manufactured trench shields. (See Appendix A of this Manual.)

The reviewing engineer should be aware that manufacturers will normally furnish engineering data to a supplier, who in turn will furnish the data to the Contractor. A Contractor may submit a sales brochure as a shoring plan for approval. A brochure is not a plan; it generally will represent the manufacturer's data (the strength or capacity of the product). A shoring plan for specific use of the shield must be prepared. The engineer can determine forces, including surcharges that are to be resisted, and then make comparisons with manufacturer's data, or with the submitting engineer's computations that define the capacity of the shoring system.

A number of the trench shoring and shield manufacturers/suppliers belong to the TRENCH AND SHIELDING ASSOCIATION. The Association has published a manual covering product use and safety with respect to trench and shoring work. Member listing and other information may be obtained from:

TRENCH SHORING AND SHIELDING ASSOCIATION
25 North Broadway
Tarrytown, N. Y. 10591 Phone (914) 332-0040

2.3 MANUFACTURED PRODUCTS

Manufactured trench shoring and worker protection products include screw jacks, hydraulic shores, screw or hydraulic operated frames, work shields and other devices used to shore a trench and/or protect workmen.

If the Contractor's shoring or worker protection plan includes a manufactured product, the Engineer should not hesitate to request from the Contractor the manufacturer's recommendations if they are needed to verify the safe load capacity of the product.

The maximum loading which may be applied per Construction Safety Orders Section 1541.1 (c)(2) to a manufactured product shall not exceed the capacities as given by the manufacturer. These are usually shown in a catalog or brochure published by the manufacturer, or in the form of a letter

from the manufacturer pertaining to the use of his product for specific job conditions. This statement may be shown on a working drawing or included in a letter. To be acceptable it must be signed by the manufacturer; not the Contractor. When professional engineering data accompanies manufactured products that data may be used with minimum supplemental review.

Be aware that some manufacturer's catalogs do not always present enough engineering data; they may only be sales brochures. Be sure to review the conditions that apply to the data submitted. This is necessary to ascertain that 'capacity ratings' and other information were established while including the minimum loads (such as surcharges) required by the CCR, Title 8. It may be necessary to request that the contractor furnish additional engineering data from the manufacturer.

The maximum allowable safe working load as recommended by the manufacturer will be based on the use of new or undamaged used material. If the product or its components are not in good condition it must be determined if the product can function as intended, or if the safe working loads should be reduced. It is the responsibility of the Contractor to furnish proof of loading capacity.

In the case of manufactured products which cannot be found in any catalog, and the manufacturer is unknown or unable to recommend a safe working load, the Engineer should require a load test to establish the safe load capacity of the product as it is to be used. A load test should be conducted to a predetermined value or to failure to determine the maximum capacity of the manufactured product. The safe working load may then be one-half of the ultimate test loading, thus a minimum safety factor of 2.

A non-commercial product generally has less quality control during its fabrication relative to a manufactured product and as such non-commercial material should have a safety factor of 3. Load tests witnessed by the Engineer should be documented in the project records and a copy submitted to Sacramento with the approved shoring plans.

Materials must be properly identified on the submitted plan and verified in the field. This is very important when analyzing aluminum members as there are many different alloys.

2.4 ALTERNATE DESIGN CONSIDERATIONS

A minimum construction surcharge of 72 pounds per square foot lateral pressure shall be included in all shoring designs. Any additional surcharge loads such as from equipment, buildings, etc., should also be included in the shoring design. Refer to CHAPTER 4, Earth Pressure Theory and Application.

Alternate allowable stresses may be used provided that it can be satisfactorily shown that these values conform to acceptable engineering practice. Refer to Allowable Working Stresses in CHAPTER 5, Structural Design of Shoring Systems.

2.5 INFORMATION ABOUT TEXT FORMATTING IN THE CONSTRUCTION SAFETY ORDERS

In the CCR, Title 8 all subtopics are usually indented the same amount only on the first line of type. The subjects and subheadings format generally conforms to the following example:

Sub Chapter	Title
Article No.	Major Heading
Section Number.	Heading.
(a)	Lower case letter used for first subtopic.
(1)	Number used for subtopic to lower case letter.
(A)	Upper case letter used for subtopic to number.
1.	Number used for subtopic to uppercase letter.
	Another Heading.

CHAPTER 3

SOILS

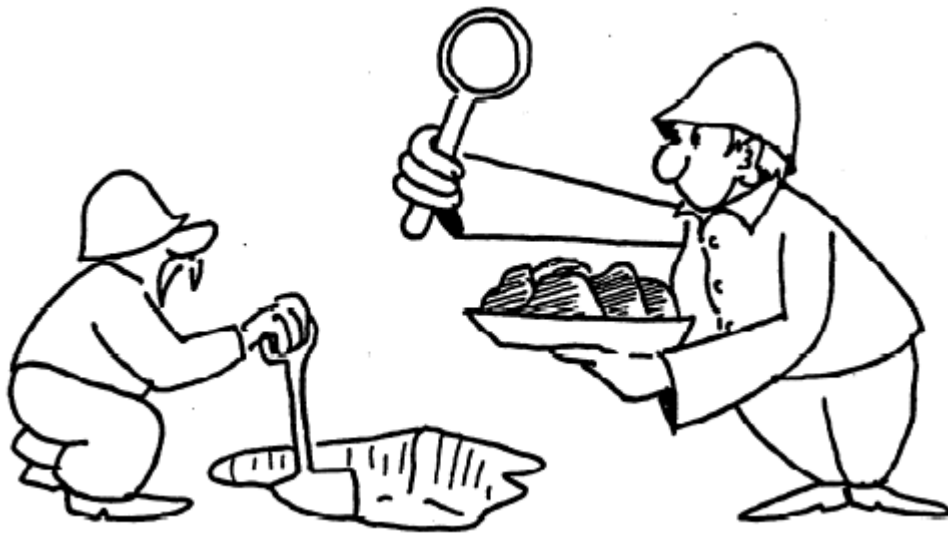

3.0 INTRODUCTION

To verify the adequacy of a shoring system in soil, it is necessary to be familiar with the types of soil in which the excavation is to be made, their properties, and expected behavior. The lateral earth pressure exerted on a shoring system depends on the soil type, its density or consistency, and other factors such as external loads, the type of retaining system used, and the construction procedure. For most projects, the geotechnical investigation and geotechnical report(s) issued by Geotechnical Services should present sufficient information for the Engineer to perform shoring design and analyses. The Engineer must contact Geotechnical Services for guidance when additional soil properties are needed for the design review or when the material encountered during the installation or construction of the shoring system differs from that assumed by the shoring system designer. This chapter discusses the Department's resources for soil information and provides guidance on how to use this information to determine parameters necessary for the design or verification of a shoring system.

3.1 SOIL IDENTIFICATION, CLASSIFICATION, DESCRIPTION AND PRESENTATION

The Contractor can obtain soil classification characteristics from the information provided in the Geotechnical Design Report or Foundation Report and corresponding Log of Test Borings, by performing independent sampling and analysis of the soil, or having a 'competent person' classify the soil as per Cal/OSHA Excavation Standard Appendix A to Section 1541.1 – Soil Classification.

As per the Cal/OSHA Appendix A, a competent person is "one who is capable of identifying existing and predictable hazards in the surroundings or working conditions which are unsanitary, hazardous, or dangerous to employees, and who has authorization to take prompt corrective measures to eliminate them." That person must have had specific training in and be knowledgeable about soils analysis, the use of protective systems, and the requirements of the Standard (Cal/OSHA).

The Cal/OSHA soil classification methods include a series of visual analysis as well as a series of manual tests. As per Cal/OSHA Section 1541.1(c) in Appendix A, the classification of soil deposits shall be made based on the results of at least one visual and at least one manual analysis.

CT TRENCHING AND SHORING MANUAL

Some of the acceptable manual tests are similar to those used in the Caltrans Soil and Rock Logging, Classification, and Presentation Manual, including Dry Strength and Pocket Penetrometer methods. The competent person will use the quantitative and qualitative information obtained from the visual and manual tests to classify the soils as either Type A (stable rock), Type B, or Type C soil. Depending on the type of soil classified, an unconfined compressive strength value is assigned. Unconfined compressive strength is defined in the Cal/OSHA standard as, ‘the load per unit area at which a soil will fail in compression.’

It is the Engineer’s responsibility to verify that the soil properties used by the Contractor’s engineer in their shoring design submittal are appropriate. It is recommended that the Engineer contact the author of the Foundation Report or Geotechnical Design Report to discuss and verify.

Caltrans uses geotechnical reports, Log of Test Boring (LOTB) sheets and Boring Records (BR) to present the results of its geotechnical and borehole investigations. LOTB sheets are included in the contract plans for structures and present the boring logs, including soil descriptions and sampling information, whereas a BR is an 8½ x 11 sheet attached to a geotechnical report pertaining to roadway facilities (cuts, fills, grading, drainage). The Caltrans *Soil and Rock Logging, Classification, and Presentation Manual*, maintained by Geotechnical Services, presents the Department’s practice for identification, classification, description and presentation of soil and rock for all investigations after August 1, 2007. The Manual is available through the Division of Engineering Services/Geotechnical Services at the following website:

http://www.dot.ca.gov/hq/esc/geotech/requests/logging_manual/logging_manual.html

Correct interpretation of LOTB sheets, BR, and related discussions in geotechnical reports requires familiarity with the Manual. The following is an overview of the Department’s soil presentation practice.

The descriptive sequence for a soil consists of a *group name* and *group symbol*, followed by descriptive components, such as density or consistency, color, moisture etc. The *group name* and *group symbol* of a soil, “SANDY lean CLAY (CL)” for example, is determined using one of the following standards:

- ASTM D 2488-06, “Standard Practice for Description and Identification of Soils (Visual-Manual Procedure), if laboratory testing is not performed

SOILS

- ASTM D 2487-06, “Standard Practice for Classification of Soils for Engineering Purposes (Unified Soil Classification System), if laboratory Particle Size Analysis and Plasticity Index tests are performed

The descriptive components following the group name and group symbol are defined in the Logging Manual. Section 2 of the Logging Manual presents the Department’s practice for identifying and describing soil in the field whereas Section 3 presents the practice of soil classification and description based on laboratory test results.

Soils are identified or classified as either *coarse-grained* (gravel and sand) or *fine-grained* (silts and clays). Natural soil consists of one or any combination of gravel, sand, silt, or clay, and may also contain boulders, cobbles, and organics.

Coarse-grained soils retain more than 50 percent of material on or above the No. 200 sieve (0.075mm). GRAVEL (G) and SAND (S) are further identified or classified according to their gradation as well-graded (W) or poorly graded (P), SILT content (M), or CLAY content (C). Examples of these are *Well-graded SAND (SW)* or *SILTY SAND (SM)*.

Fine-grained soils pass more than 50 percent of material through the No. 200 sieve. SILT (M), CLAY (C), and ORGANIC SOIL (O) are further identified by visual methods or classified by laboratory plasticity tests as low plasticity (L) or high plasticity (H). Examples of these are *Lean CLAY (CL)* or *SANDY SILT (ML)*.

3.2 SOIL PROPERTIES and STRENGTH

Characteristics or properties that help predict the effect of a soil on a shoring system include the particle distribution (%gravel, %sand, %fines (silt & clay)), particle angularity, apparent density or consistency (strength), moisture, and unit weight. The Logging Manual presents the Department’s standards of measuring or determining these properties either visually (Section 2) or with laboratory testing (Section 3).

Typically, the Department uses one or more of the following investigative methods to determine a soil’s identification, classification, description and strength:

- Standard Penetration Test (SPT) with visual/manual methods
- Cone Penetration Test (CPT)
- Laboratory Testing

3.3 STANDARD PENETRATION TEST (SPT)

The Standard Penetration Test (SPT) obtains a disturbed sample of soil for visual identification and description, and/or laboratory testing (particle size analysis, plasticity index). The number of hammer blows required to drive the 12^k sampler, is referred to as N value. When corrected for the SPT hammer's energy efficiency, it becomes N_{60} . This can be used to determine the apparent density of a granular soil. Empirical relationships to approximate the soil friction angle (ϕ) and density are shown in Table 3-1.

Table 3-1. Properties Granular Soils

Apparent Density	Relative Density (%)	SPT, N_{60} (blows/ft)	Friction Angle, ϕ (deg)	Unit Weight (pcf)	
				Moist	Submerged
Very Loose	0-15	$N_{60} < 5$	<28	<100	<60
Loose	16-35	$5 \leq N_{60} < 10$	28-30	95-125	55-65
Medium Dense	36-65	$10 \leq N_{60} < 30$	31-36	110-130	60-70
Dense	66-85	$30 \leq N_{60} < 50$	37-41	110-140	65-85
Very Dense	86-100	$N_{60} \geq 50$	>41	>130	>75

Note that both the LOTB and BR report the SPT blow count observed in the field as the N value, not N_{60} as used above to determine the apparent density descriptor. The reader is encouraged to read the Logging Manual on Apparent Density and Appendix A.8 on SPT prior to using Table 3-1. Note: there are a variety of correction factors that can be applied to the N value such as for overburden pressure. It is important to know what, if any, correction factors have been applied to the N value for the correct interpretation of Table 3-1.

The Division of Engineering Services, Office of Geotechnical Services has prepared a summary of "simplified typical soil values." For average trench conditions, the Engineer will find the data very useful to establish basic properties or evaluate data submitted by the contractor. Table 3-2 lists approximate values.

SOILS

Table 3-2. Simplified Typical Soil Values

Soil Classification	ϕ Friction Angle of the Soil	Density or Consistency	γ Soil Unit Weight (pcf)	K_a Coefficient of Active Earth Pressure	$K_w=K_a\gamma$ Equiv. Fluid Wt. (pcf)
Gravel, Gravel-Sand Mixture, Coarse Sand	41	Dense	130	0.21	27
	34	Medium Dense	120	0.28	34
	29	Loose	90	0.35	32
Medium Sand	36	Dense	117	0.26	30
	31	Medium Dense	110	0.32	35
	27	Loose	90	0.38	34
Fine Sand	31	Dense	117	0.32	37
	27	Medium Dense	100	0.38	38
	25	Loose	85	0.41	34
Fine Silty Sand, Sandy Silt	29	Dense	117	0.35	41
	27	Medium Dense	100	0.38	38
	25	Loose	85	0.41	34
Silt	27	Dense	120	0.38	45
	25	Medium Dense	110	0.41	45
	23	Loose	85	0.44	37

For active pressure conditions, use a unit weight value of $\gamma = 115$ pcf minimum when insufficient soils data is known.

It is not the Department's practice to use the SPT test as a means of estimating the shear strength of cohesive soil. Field tests on relatively undisturbed samples including the pocket penetrometer, torvane, and laboratory tests such as triaxial, unconfined compression and direct shear are considered more accurate and are discussed in the Logging Manual. Field and/or laboratory test results are typically available in the Foundation Report and/or Geotechnical Design Report issued by Geotechnical Services staff, and it is recommended that the Engineer use those results in their shoring analyses. In the absence of any field or laboratory test results for cohesive soil, the consistency descriptor can be roughly correlated to shear strength and density as shown in Table 3-3.

Table 3-3. Properties Cohesive Soils

Consistency	Unconfined Compressive Strength (psf)	Moist Unit Weight (pcf)
Very Soft	0-500	<100-110
Soft	500-1,000	100-120
Medium Stiff	1,000-2,000	110-125
Stiff	2,000-4,000	115-130
Very Stiff	4,000-8,000	120-140
Hard	>8,000	>132

3.4 CONE PENETRATION TEST (CPT)

The Cone Penetration Test (CPT) is used by the Department to determine the in situ properties of soil. The CPT consists of pushing a conically tipped, cylindrical probe into the ground at a constant rate. The probe is instrumented with strain gages to measure resisting force against the tip and along the side while the probe is advancing downward. A computer controls the advance of the probe and the acquisition of data and a nearly continuous record of subsurface information collected. The results of a CPT are presented on either a LOTB plan sheet or on an 8 ½ x 11 sheets as presented in Figure 3-1 and Figure 3-2..

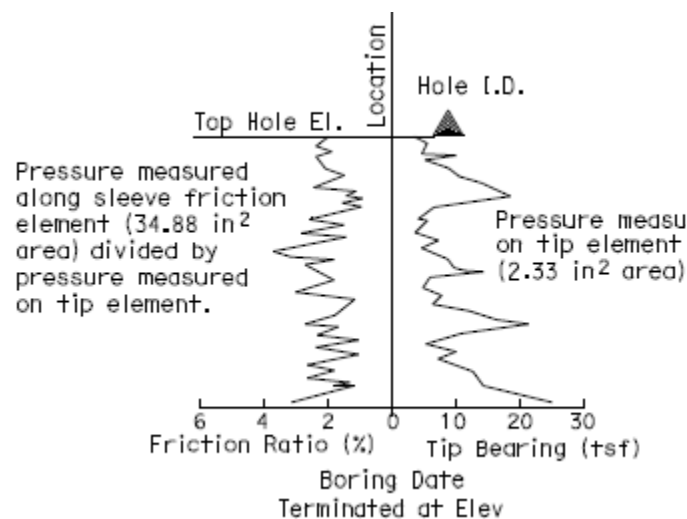

Figure 3-1. Cone Penetration Test (CPT) Boring

SOILS

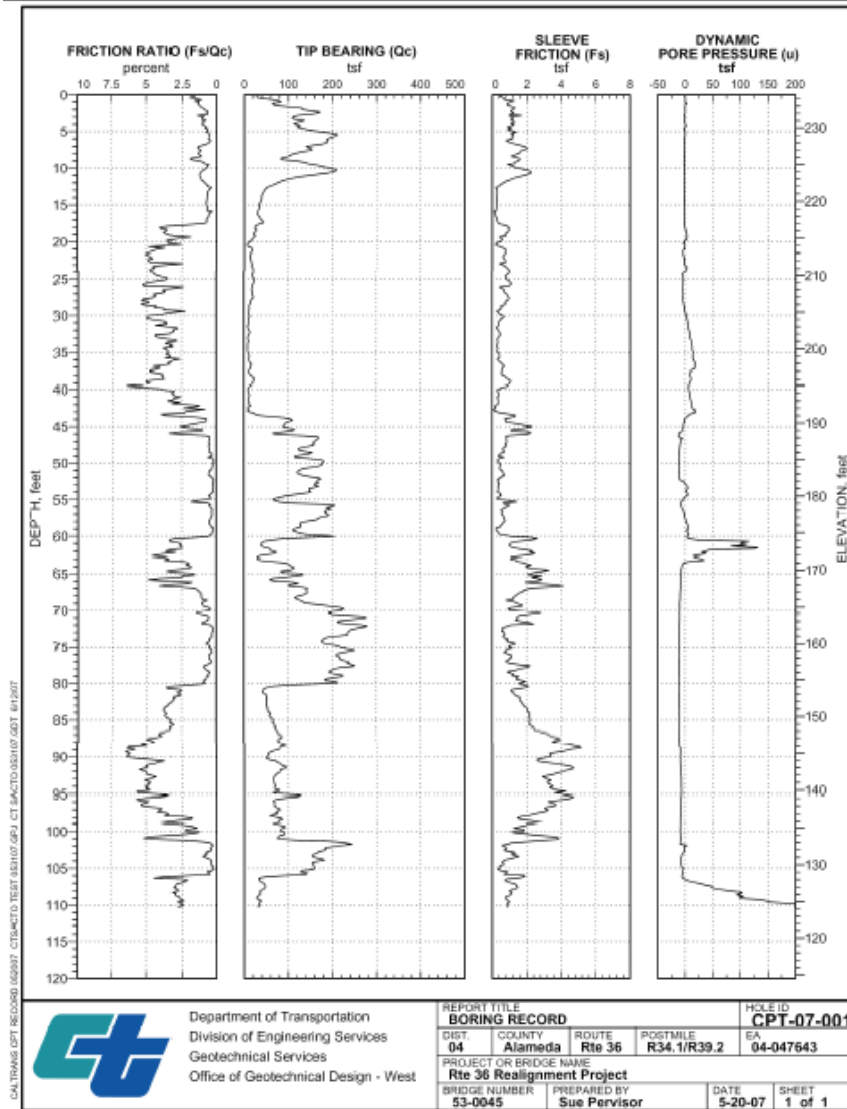

Figure 3-2. Typical CPT Plot

The CPT cannot recover soil samples, so visual/manual soil identification is not possible. However, it is possible to obtain approximate soil identification, relative density for granular soils, and undrained shear strength (S_u) for fine grained soils by using several published relationships. The Engineer should review the appropriate project geotechnical report(s) for discussions relative to soil identification and strength from CPT investigations or to contact Geotechnical Services for guidance on the interpretation of CPT data relating to shoring analysis and design.

3.5 FIELD and LABORATORY TESTS

Not all methods of evaluating soil shear strength are equally accurate. Therefore, the source of the shear strength data must be considered when evaluating a proposed trenching or shoring system. Table 3-4 presents a list of field and laboratory tests that are used to measure or estimate soil shear strength and an indication of their reliability.

Table 3-4. Field and Laboratory Test Reliability of Soil Shear Strength Measurements

Test Method	Coarse-grained Soil	Fine-grained Soil
Standard Penetration Test (SPT) (ASTM D 1588)	Good	Poor
Cone Penetration Test (CPT) (ASTM D 3441)	Good	Fair
Pocket Penetrometer	Not applicable	Fair
Vane Shear (ASTM D 2573)	Not applicable	Very good
Triaxial Compression (UU,CU) (ASTM D 2850)	Very good*	Very Good
Unconfined Compression (ASTM D 2166)	Not applicable	Very good
Direct Shear (ASTM D 3080)	Good*	Fair

*Recovery of undisturbed samples can be difficult

3.6 SHEAR STRENGTH

The shear strength of soil is measured by two parameters, the angle of internal friction ϕ , which is the resistance to interparticle slip, and the soil cohesion, which is the interparticle attraction of the soil particles. The design of most geotechnical structures requires a quantitative determination of the soil shear strength. One of the fundamental relationships governing soil shear strength is:

$$\tau_f = c + \sigma \tan\phi \quad \text{Eq. 3-1}$$

Where:

τ_f = Soil Shear Strength at Failure.

ϕ = Internal Friction Angle.

σ = Normal Stress.

c = Soil Cohesion.

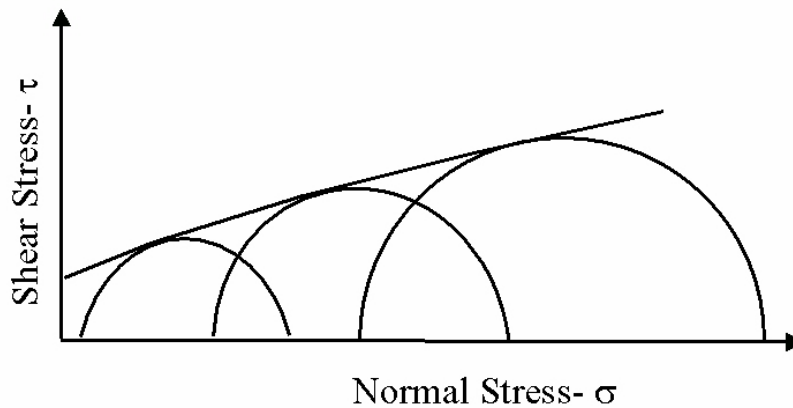

Figure 3-3. Mohr-Coulomb Criteria

In general, the relationship between shear strength and normal stress is not linear for large stress ranges. The strength envelope is a curve that is tangent to the Mohr circles as shown in Figure 3-3. The point of tangency to the Mohr circles represents the stress conditions on the failure plane of the sample.

In fine-grained (cohesive) soils, shear strength is initially insensitive to confining pressure, and derive their strength through cohesion (interparticle attraction). For cohesive soils, the failure criterion simplifies to:

$$\tau_f = S_u \quad \text{Eq. 3-2}$$

Where S_u is the undrained shear strength.

Cohesive soils will consolidate or swell over time depending on whether the soil has been loaded or unloaded, respectively. Trenching and shoring work often creates situations where soil loading is reduced, such as in an excavation. A fine-grained soil subjected to unloading will then expand and has the potential to lose shear strength over time.

3.7 CONTRACTOR SOIL INVESTIGATIONS

The Contractor may elect to have a soils investigation performed to support his shoring design. In this case the soils information or report will be furnished to the Engineer as part of the supporting data accompanying the shoring plans. Soil test results need to be used with caution. Soil test reports from many soils laboratories or similar sources may or may not include safety factors incorporated in the reported results.

Factors that the Engineer will consider when assigning strength parameters to a soil include:

- The method with which soil shear strength was determined (Table 3-4),
- The variability of subsurface profile, and
- The number and distribution of shear strength tests.

3.8 SPECIAL GROUND CONDITIONS

Occasionally, excavations are made into soil or rock with properties that require special consideration in the design of the shoring system. The special condition must be defined and the expected behavior understood of the material during and after excavation and installation of the shoring system. Typically the geotechnical report would identify and discuss the presence of special soil or rock conditions and it is recommended that Geotechnical Services be contacted for assistance with these situations. Examples of special ground conditions are:

- **Fractured rock:** Adversely oriented bedding or fracturing, which would allow toppling or wedge failure into the excavation, should be identified and accounted for in the design of the shoring system.
- **Organic soil:** Organic soils, such as peat, are compressible and subject to decomposition which can lead to significant volume changes.
- **Clay and shale:** Subject to cracking and spalling upon exposure to the atmosphere, swelling and slaking when exposed to water, and weakening when unloaded. Excavating such materials might require protection of the shoring system to help retain natural moisture content to prevent cracking and spalling. Design analyses need to account for the expected disturbed strength of the retained material, which might be weaker than insitu.
- **Running soil:** A soil that cannot stand by itself even for a short term. Running soil will have little shear strength and will flow with virtually no angle of repose in an unsupported condition. For running soil conditions, the full dry weight or the saturated unit weight of material has to be resisted. The angle of friction (ϕ) and the cohesive value (c) are both zero.
- **Quick condition:** Occurs when the upward flow of water through a soil is sufficient to make the soil buoyant and thereby prevent grain interlocking. The soil grains are suspended in the water. A quick condition can be developed by adverse water flow. It may best be stabilized when the trench is dewatered. Quick conditions can occur in some silt as well as in sand.

CHAPTER 4

EARTH PRESSURE

THEORY AND

APPLICATION

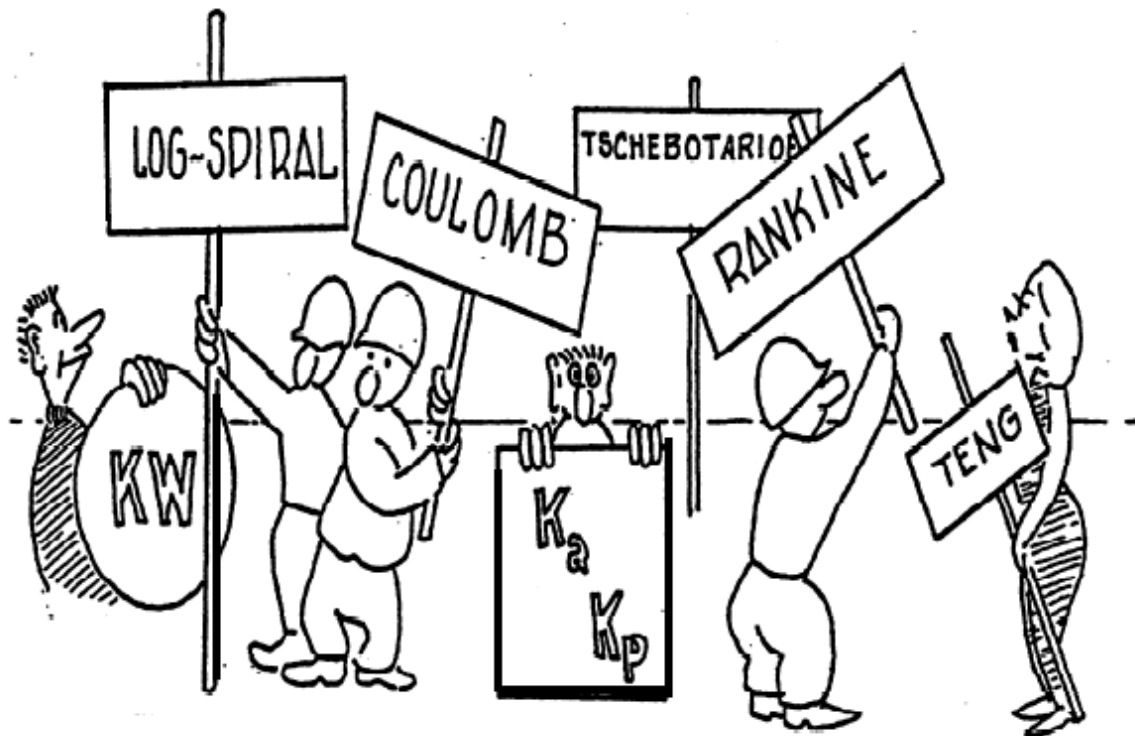

4.0 GENERAL

All shoring systems shall be designed to withstand lateral earth pressure, water pressure and the effect of surcharge loads in accordance with the general principles and guidelines specified in this Caltrans Trenching and Shoring Manual.

4.1 SHORING TYPES

Shoring systems are generally classified as unrestrained (non-gravity cantilevered), and restrained (braced or anchored). Unrestrained shoring systems rely on structural components of the wall partially embedded in the foundation material to mobilize passive resistance to lateral loads. Restrained shoring systems derive their capacity to resist lateral loads by their structural components being restrained by tension or compression elements connected to the vertical structural members of the shoring system and, additionally, by the partial embedment (if any) of their structural components into the foundation material.

4.1.1 Unrestrained Shoring Systems

Unrestrained shoring systems (non-gravity cantilevered walls) are constructed of vertical structural members consisting of partially embedded soldier piles or continuous sheet piles. This type of system depends on the passive resistance of the foundation material and the moment resisting capacity of the vertical structural members for stability; therefore its maximum height is limited by the competence of the foundation material and the moment resisting capacity of the vertical structural members. The economical height of this type of wall is generally limited to a maximum of 18 feet.

4.1.2 Restrained Shoring Systems

Restrained Shoring Systems are either anchored or braced walls. They are typically comprised of the same elements as unrestrained (non-gravity cantilevered) walls, but derive additional lateral resistance from one or more levels of braces, rakers, or anchors. These walls are typically constructed in cut situations in which construction proceeds from the top down to the base of the wall. The vertical wall elements should extend below the potential failure plane associated with the retained soil mass. For these types of walls, economical wall heights up to 80 feet are feasible.

Note - Soil Nail Walls and Mechanically Stabilized Earth (MSE) Walls are not included in this Manual. Both of these types of systems are designed by other methods that can be found on-line with FHWA or AASHTO.

4.2 LOADING

A major issue in providing a safe shoring system design is to determine the appropriate earth pressure loading diagram. The loads are to be calculated using the appropriate earth pressure theories. The lateral horizontal stresses (σ) for both active and passive pressure are to be calculated based on the soil properties and the shoring system. Earth pressure loads on a shoring system are a function of the unit weight of the soil, location of the groundwater table, seepage forces, surcharge loads, and the shoring structure system. Shoring systems that cannot tolerate any movement should be designed for at-rest lateral earth pressure. Shoring systems which can move away from the soil mass should be designed for active earth pressure conditions, depending on the magnitude of the tolerable movement. Any movement, which is required to reach the minimum active pressure or the maximum passive pressure, is a function of the wall height and the soil type. Significant movement is necessary to mobilize the full passive pressure. The variation of lateral stress between the active and passive earth pressure values can be brought about only through lateral movement within the soil mass of the backfill as shown in Figure 4-1.

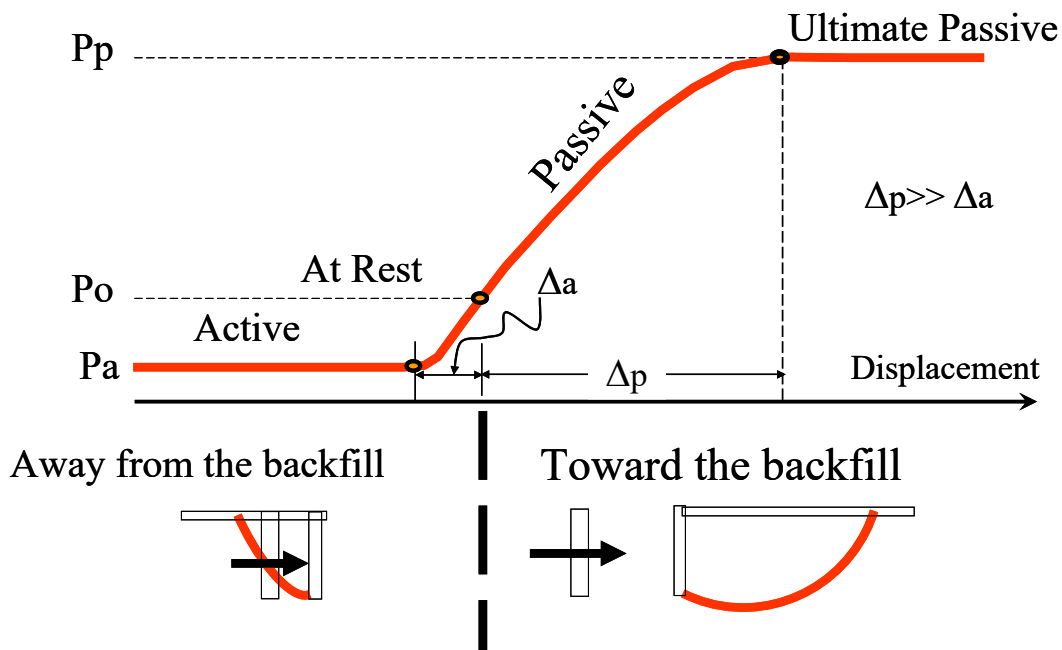

Figure 4-1. Active and passive earth pressure coefficient as a function of wall displacement

EARTH PRESSURE THEORY AND APPLICATION

Typical values of these mobilizing movements, relative to wall height, are given in Table 4-1 (Clough 1991).

Table 4-1. Mobilized Wall Movements

Type of Backfill	Value of Δ/H	
	Active	Passive
Dense Sand	0.001	0.01
Medium Dense Sand	0.002	0.02
Loose Sand	0.004	0.04
Compacted Silt	0.002	0.02
Compacted Lean Clay	0.01	0.05
Compacted Fat Clay	0.01	0.05

where:

Δ = the movement of top of wall required to reach minimum active or maximum passive pressure, by tilting or lateral translation, and

H = height of wall.

4.3 GRANULAR SOIL

At present, methods of analysis in common use for retaining structures are based on Rankine (1857) and Coulomb (1776) theories. Both methods are based on the limit equilibrium approach with an assumed planar failure surface. Developments since 1920, largely due to the influence of Terzaghi (1943), have led to a better understanding of the limitations and appropriate applications of classical earth pressure theories. Terzaghi assumed a logarithmic failure surface. Many experiments have been conducted to validate Coulomb's wedge theory and it has been found that the sliding surface is not a plane, but a curved surface as shown in Figure 4-2 (Terzaghi 1943).

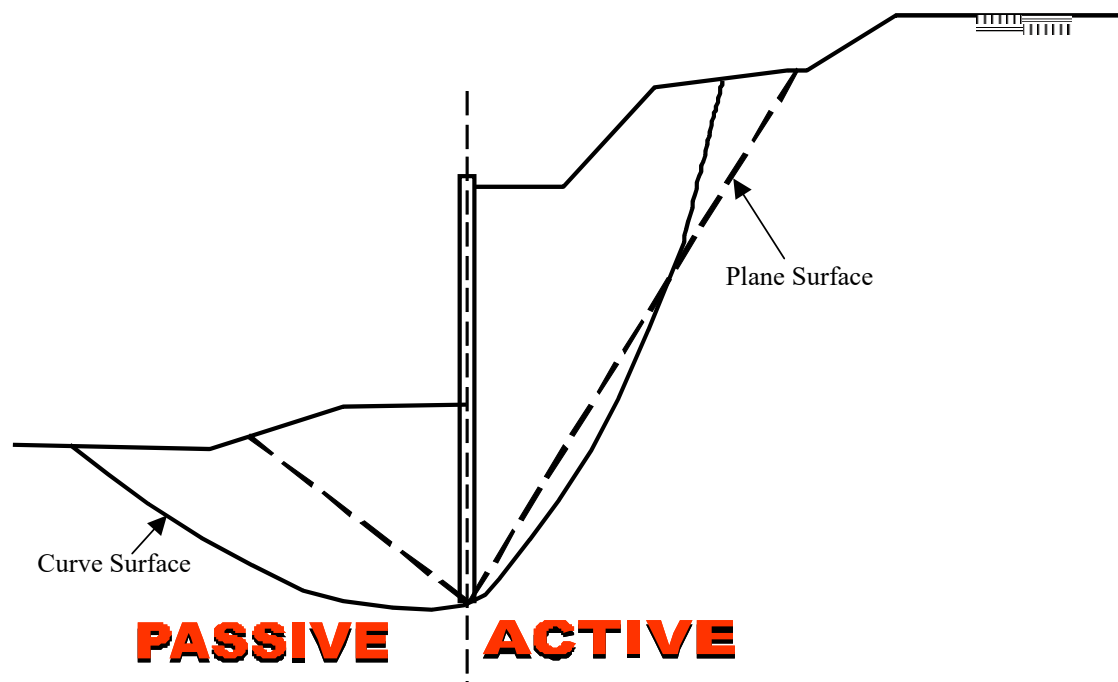

Figure 4-2. Comparison of Plane versus Curve Failure Surfaces

Furthermore, these experiments have shown that the Rankine (1857) and Coulomb (1776) earth pressure theories lead to quite accurate results for the active earth pressure. However, for the passive earth pressure, these theories are accurate only for the backfill of clean dry sand for a low wall interface friction angle.

For the purpose of the initial discussion, it is assumed that the backfills are level, homogeneous, isotropic and distribution of vertical stress (σ_v) with depth is hydrostatic as shown in Figure 4-3.

EARTH PRESSURE THEORY AND APPLICATION

The horizontal stress (σ_h) is linearly proportional to depth and is a multiple of vertical stress (σ_v) as shown in. Eq. 4-1.

$$\sigma_h = \sigma_v K = \gamma h K \quad \text{Eq. 4-1}$$

$$P = \frac{1}{2} \sigma_h h \quad \text{Eq. 4-2}$$

Depending on the wall movement, the coefficient K represents active (K_a), passive (K_p) or at-rest (K_o) earth pressure coefficient in the above equation.

The resultant lateral earth load, P , which is equal to the area of the load diagram, shall be assumed to act at a height of $h/3$ above the base of the wall, where h is the height of the pressure surface, measured from the surface of the ground to the base of the wall. P is the force that causes bending, sliding and overturning in the wall.

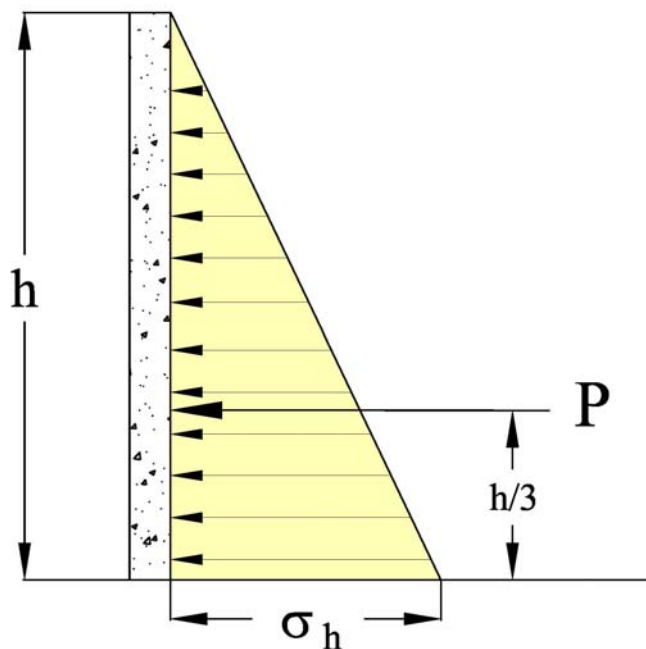

Figure 4-3. Lateral Earth Pressure Variation with Depth

Depending on the shoring system the value of the active and/or passive pressure can be determined using either the Rankine, Coulomb, Log Spiral and Trial Wedge methods.

The state of the active and passive earth pressure depends on the expansion or compression transformation of the backfill from elastic state to state of plastic equilibrium. The concept of the active and passive earth pressure theory can be explained using a continuous deadman near the

ground surface for the stability of a sheet pile wall as shown in Figure 4-4. As a result of wall deflection, Δ , the tie rod is pulled until the active and passive wedges are formed behind and in front of the deadman. Element P, in the front of the deadman and element A, at the front of the deadman are acted on by two principal stresses, a vertical stress (σ_v) and horizontal stress (σ_h). In the active case, the horizontal stress (σ_a) is the minor principal stress and the vertical stress (σ_v) is the major principal stress. In the passive case, the horizontal stress (σ_p) is the major principal stress and the vertical stress (σ_v) is the minor principal stress. The resulting failure surface within the soil mass corresponding to active and passive earth pressure for the cohesionless soil is shown in Figure 4-4.

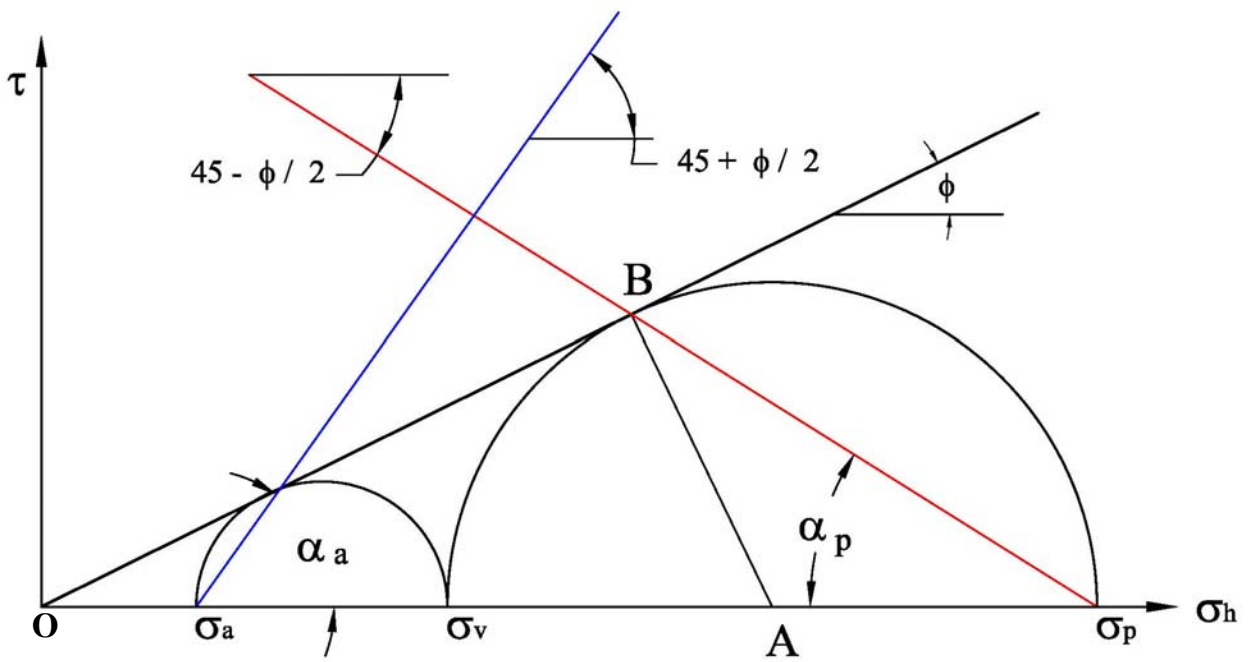
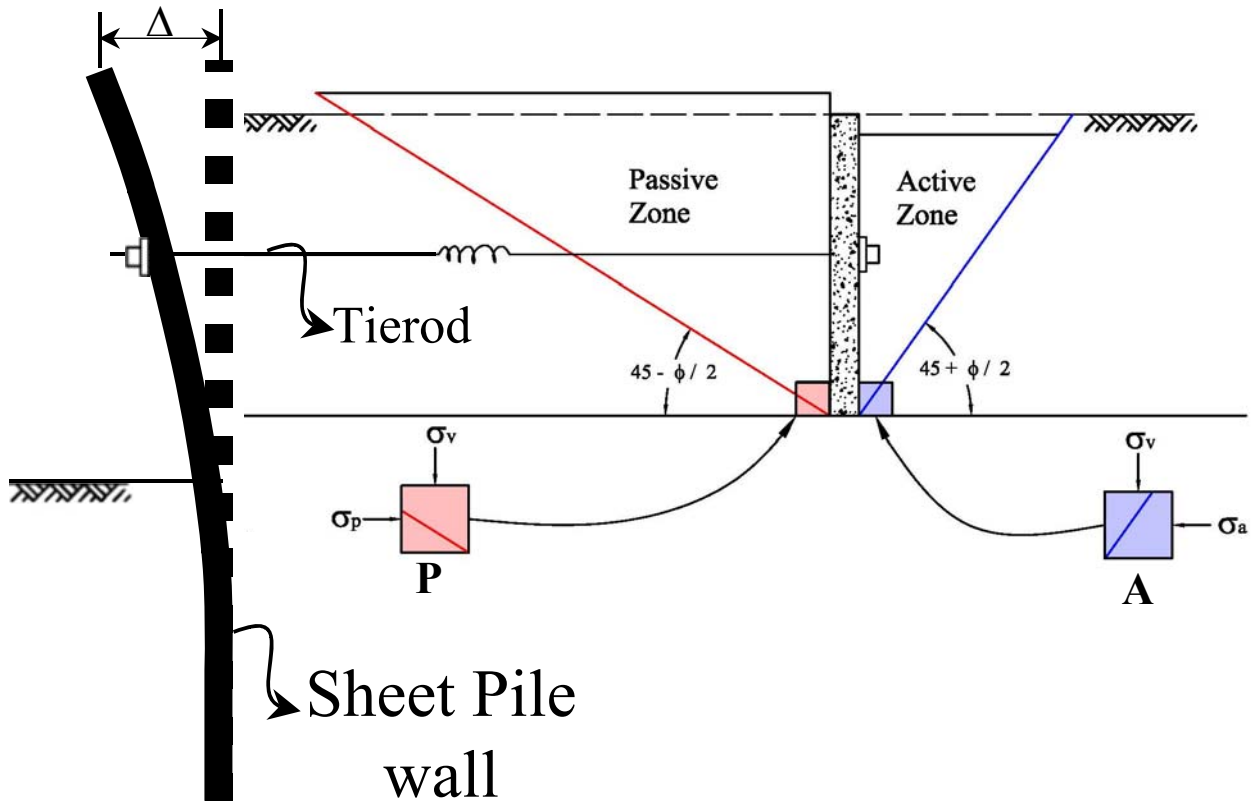

Figure 4-4. Mohr Circle Representation of Earth Pressure for Cohesionless Backfill

From Figure 4-4 above:

$$\sin \phi = \frac{AB}{OA} = \frac{\frac{\sigma_v - \sigma_a}{2}}{\frac{\sigma_v + \sigma_a}{2}} \quad \text{Eq. 4-3}$$

Where AB is the radius of the circle

$$\sin \phi = \frac{AB}{OA} = \frac{\sigma_v - \sigma_a}{\sigma_v + \sigma_a} \quad \text{Eq. 4-4}$$

$$\sigma_v \sin \phi + \sigma_a \sin \phi = \sigma_v - \sigma_a \quad \text{Eq. 4-5}$$

Collecting Terms:

$$\sigma_a + \sigma_a (\sin \phi) = \sigma_v - \sigma_v (\sin \phi) \quad \text{Eq. 4-6}$$

$$\sigma_a (1 + \sin \phi) = \sigma_v (1 - \sin \phi) \quad \text{Eq. 4-7}$$

$$\frac{\sigma_a}{\sigma_v} = \frac{(1 - \sin \phi)}{(1 + \sin \phi)} \quad \text{Eq. 4-8}$$

From trigonometric identities:

$$\frac{(1 - \sin \phi)}{(1 + \sin \phi)} = \tan^2 \left(45 - \frac{\phi}{2} \right)$$

$$\frac{(1 + \sin \phi)}{(1 - \sin \phi)} = \tan^2 \left(45 + \frac{\phi}{2} \right)$$

$$K_a = \tan^2 \left(45 - \frac{\phi}{2} \right), \text{ where } K_a = \frac{\sigma_a}{\sigma_v} \quad \text{Eq. 4-9}$$

For the passive case:

$$K_p = \frac{\sigma_p}{\sigma_v} = \frac{1 + \sin \phi}{1 - \sin \phi} = \tan^2 \left(45 + \frac{\phi}{2} \right) \quad \text{Eq. 4-10}$$

There are various pros and cons to the individual earth theories but briefly here is a summary:

- The Rankine formula for passive pressure can only be used correctly when the embankment slope angle, β , equals zero or is negative. If a large wall friction value can develop, the Rankine Theory is not correct and will give less conservative results. Rankine's theory is not intended to be used for determining earth pressures directly against a wall (friction angle does not appear in equations above). The theory is intended to be used for determining earth pressures on a vertical plane within a mass of soil.

EARTH PRESSURE THEORY AND APPLICATION

- For the Coulomb equation, if the shoring system is vertical and the backfill slope friction angles are zero, the result will be the same as Rankine's for a level ground condition. Since wall friction requires a curved surface of sliding to satisfy equilibrium, the Coulomb formula will give only approximate results since it assumes planar failure surfaces. The accuracy for Coulomb will diminish with increased depth. For passive pressures the Coulomb formula can also give inaccurate results when there is a large back slope or wall friction angle. These conditions should be investigated and an increased factor of safety considered.
- The Log-Spiral theory was developed because of the unrealistic values of earth pressures that are obtained by theories that assume a straight line failure plane. The difference between the Log-Spiral curved failure surface and the straight line failure plane can be large and on the unsafe side for Coulomb passive pressures (especially when wall friction exceeds $\phi/3$). Figure 4-2 and Figure 4-31 show a comparison of the Coulomb and Rankine failure surfaces (plane) versus the Log-Spiral failure surface (curve).
- More on Log-Spiral can be found in Section 4.7 of this Manual.

4.3.1 At-Rest Lateral Earth Pressure Coefficient (K_0)

For a zero lateral strain condition, horizontal and vertical stresses are related by the Poisson's ratio (μ) as follows:

$$K_0 = \frac{\mu}{1 - \mu} \quad \text{Eq. 4-11}$$

For normally consolidated soils and vertical walls, the coefficient of at-rest lateral earth pressure may be taken as:

$$K_0 = (1 - \sin \phi)(1 - \sin \beta) \quad \text{Eq. 4-12}$$

Where:

ϕ = effective friction angle of soil.

K_0 = coefficient of at-rest lateral earth pressure.

β = slope angle of backfill surface behind retaining wall.

For over consolidated soils, level backfill, and a vertical wall, the coefficient of at-rest lateral earth pressure may be assumed to vary as a function of the over consolidation ratio or stress history, and may be taken as:

$$K_0 = (1 - \sin \phi)(OCR)^{\sin \phi} \quad \text{Eq. 4-13}$$

Where:

OCR = over consolidation ratio

4.3.2 Active and/or Passive Earth Pressure

Depending on the shoring system the value of the active and/or passive pressure can be determined using either the Rankine, Coulomb or trial wedge methods.

4.3.2.1 Rankine's Theory

Rankine's theory is the simplest formulation proposed for earth pressure calculations and it is based on the following assumptions:

- The wall is smooth and vertical.
- No friction or adhesion between the wall and the soil.
- The failure wedge is a plane surface and is a function of soil's friction ϕ and the backfill slope β as shown in Eq. 4-14 and Eq. 4-17.
- Lateral earth pressure varies linearly with depth.
- The direction of the lateral earth pressure acts parallel to slope of the backfill as shown in Figure 4-5 and Figure 4-6.
- The resultant earth pressure acts at a distance equal to one-third of the wall height from the base.

Values for the coefficient of active lateral earth pressure using the Rankine Theory may be taken as shown in Eq. 4-14:

$$K_a = \cos\beta \frac{\cos\beta - \sqrt{\cos^2\beta - \cos^2\phi}}{\cos\beta + \sqrt{\cos^2\beta - \cos^2\phi}} \quad \text{Eq. 4-14}$$

And the magnitude of active earth pressure can be determined as shown in Figure 4-5 and Eq. 4-15:

$$P_a = \frac{1}{2}(\gamma)(h^2)(K_a) \quad \text{Eq. 4-15}$$

The failure plane angle α can be determined as shown in Eq. 4-16:

$$\alpha = \left(45 + \frac{\phi}{2}\right) - \frac{1}{2} \left(\text{Arc sin} \left(\frac{\sin\beta}{\sin\phi} \right) - \beta \right) \quad \text{Eq. 4-16}$$

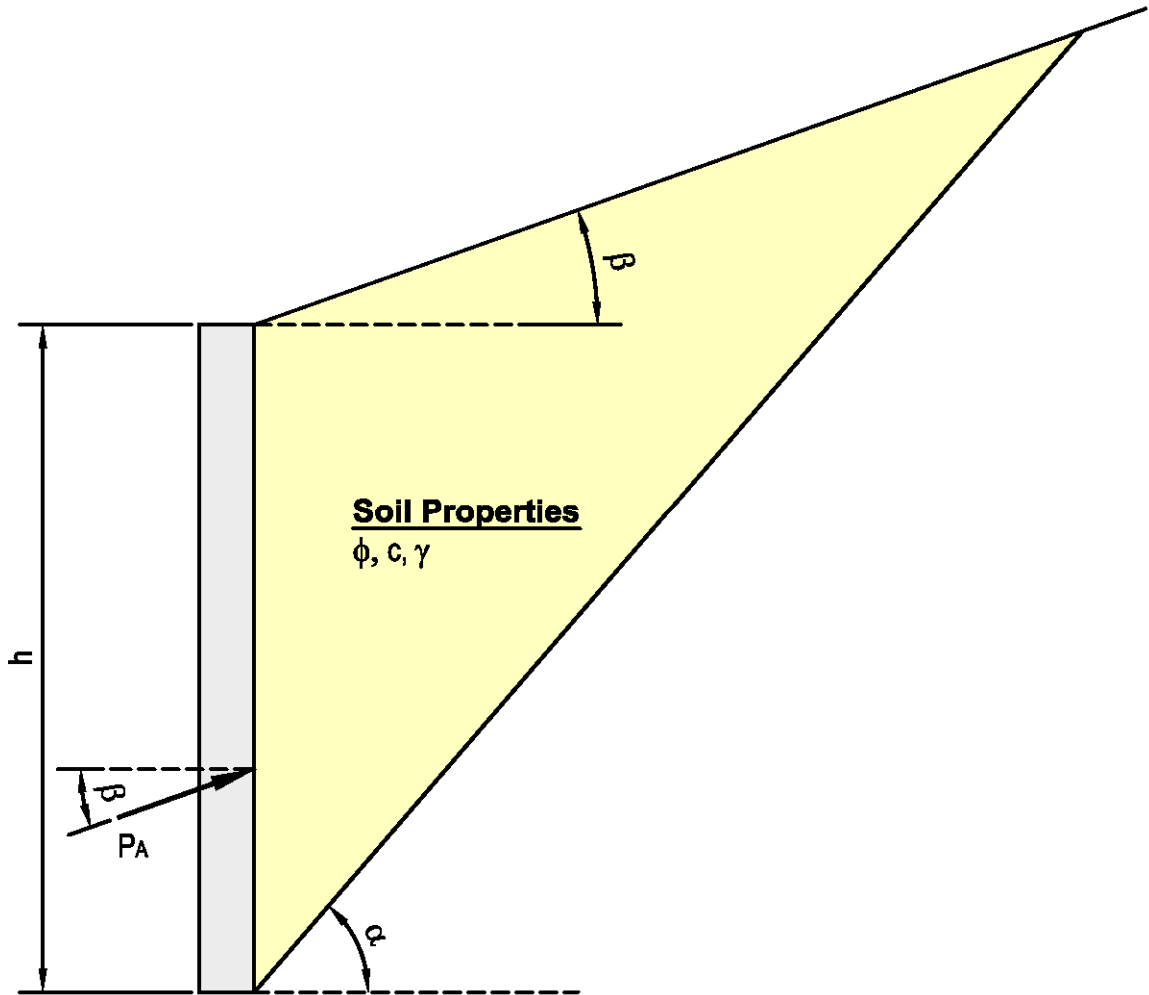

Figure 4-5. Rankine's active wedge

Rankine made similar assumptions to his active earth pressure theory to calculate the passive earth pressure. Values for the coefficient of passive lateral earth pressure may be taken as:

$$K_p = \cos\beta \frac{\cos\beta + \sqrt{\cos^2\beta - \cos^2\phi}}{\cos\beta - \sqrt{\cos^2\beta - \cos^2\phi}} \quad \text{Eq. 4-17}$$

And the magnitude of passive earth pressure can be determined as shown in Figure 4-6 and Eq. 4-18:

$$P_p = \frac{1}{2}(\gamma)(h^2)(K_p) \quad \text{Eq. 4-18}$$

The failure plane angle α can be determined as shown in Eq. 4-19:

$$\alpha = \left(45 - \frac{\phi}{2} \right) + \frac{1}{2} \left(\text{Arc sin} \left(\frac{\sin \beta}{\sin \phi} \right) + \beta \right) \quad \text{Eq. 4-19}$$

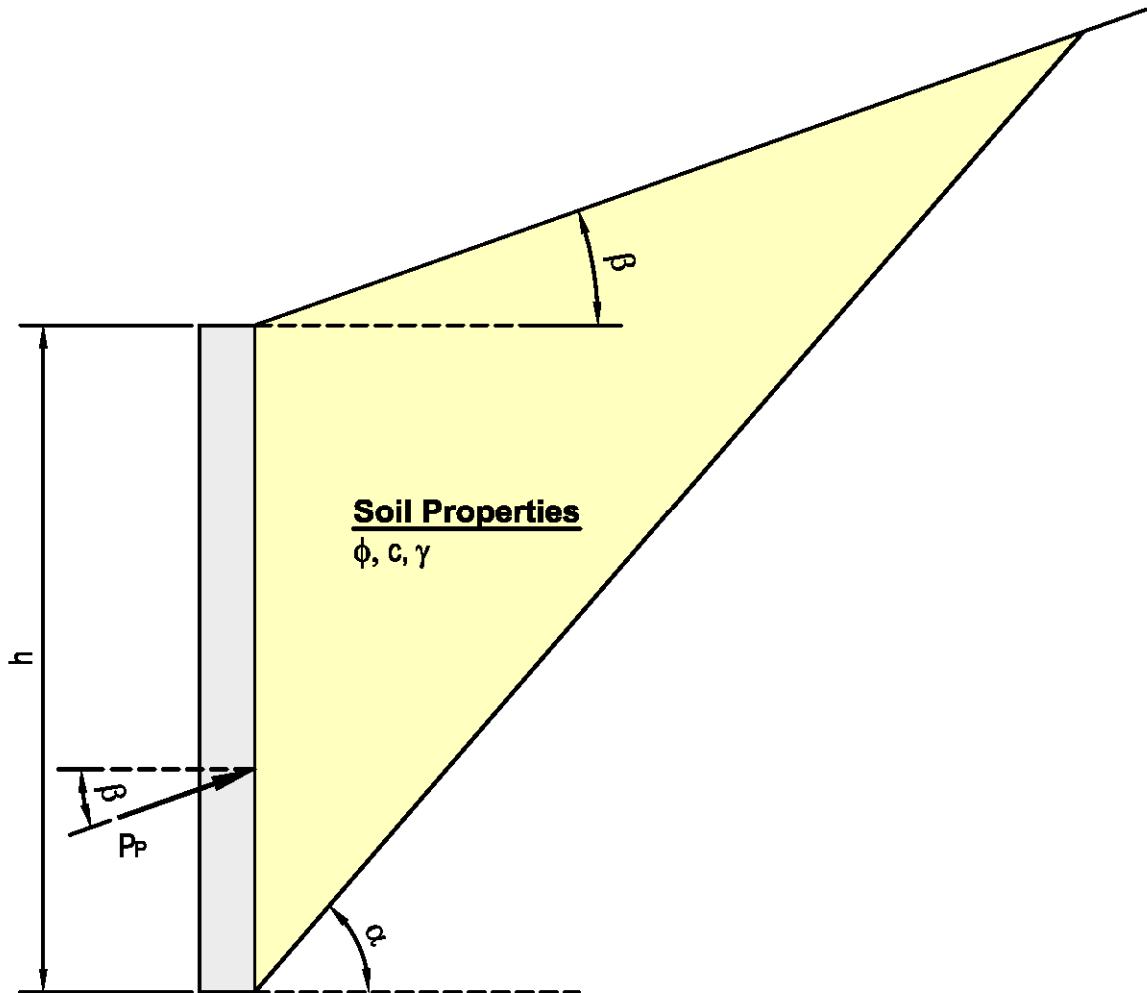

Figure 4-6. Rankine's passive wedge

Where:

h = height of pressure surface on the wall.

P_a = active lateral earth pressure resultant per unit width of wall.

P_p = passive lateral earth pressure resultant per unit width of wall.

β = angle from backfill surface to the horizontal.

α = failure plane angle with respect to horizontal.

ϕ = effective friction angle of soil.

K_a = coefficient of active lateral earth pressure.

K_p = coefficient of passive lateral earth pressure.

γ = unit weight of soil.

Although Rankine's equation for the passive earth pressure is provided above, one should not use the Rankine method to calculate the passive earth pressure when the backfill angle is greater than zero ($\beta > 0$). As a matter of fact the K_p value for both positive ($\beta > 0$) and negative ($\beta < 0$) backfill slope is identical. This is clearly not correct. Therefore, avoid using the Rankine equation to calculate the passive earth pressure coefficient for sloping ground.

4.3.2.2 Coulomb's Theory

Coulomb's (1776) earth pressure theory is based on the following assumptions:

- The wall is rough.
- There is friction or adhesion between the wall and the soil.
- The failure wedge is a plane surface and is a function of the soil friction ϕ , wall friction δ , the backfill slope β and the slope of the wall ω .
- Lateral earth pressure varies linearly with depth.
- The direction of the lateral earth pressure acts at an angle δ with a line that is normal to the wall.
- The resultant earth pressure acts at a distance equal to one-third of the wall height from the base.

EARTH PRESSURE THEORY AND APPLICATION

Values for the coefficient of active lateral earth pressure may be taken as shown in Eq. 4-20:

$$K_a = \frac{\cos^2(\phi - \omega)}{\cos^2 \omega \cos(\delta + \omega) \left[1 + \sqrt{\frac{\sin(\delta + \phi) \sin(\phi - \beta)}{\cos(\delta + \omega) \cos(\omega - \beta)}} \right]^2} \quad \text{Eq. 4-20}$$

And the magnitude of active earth pressure can be determined as shown in Figure 4-7 and Eq. 4-21:

$$P_a = \frac{1}{2}(\gamma)(h^2)(K_a) \quad \text{Eq. 4-21}$$

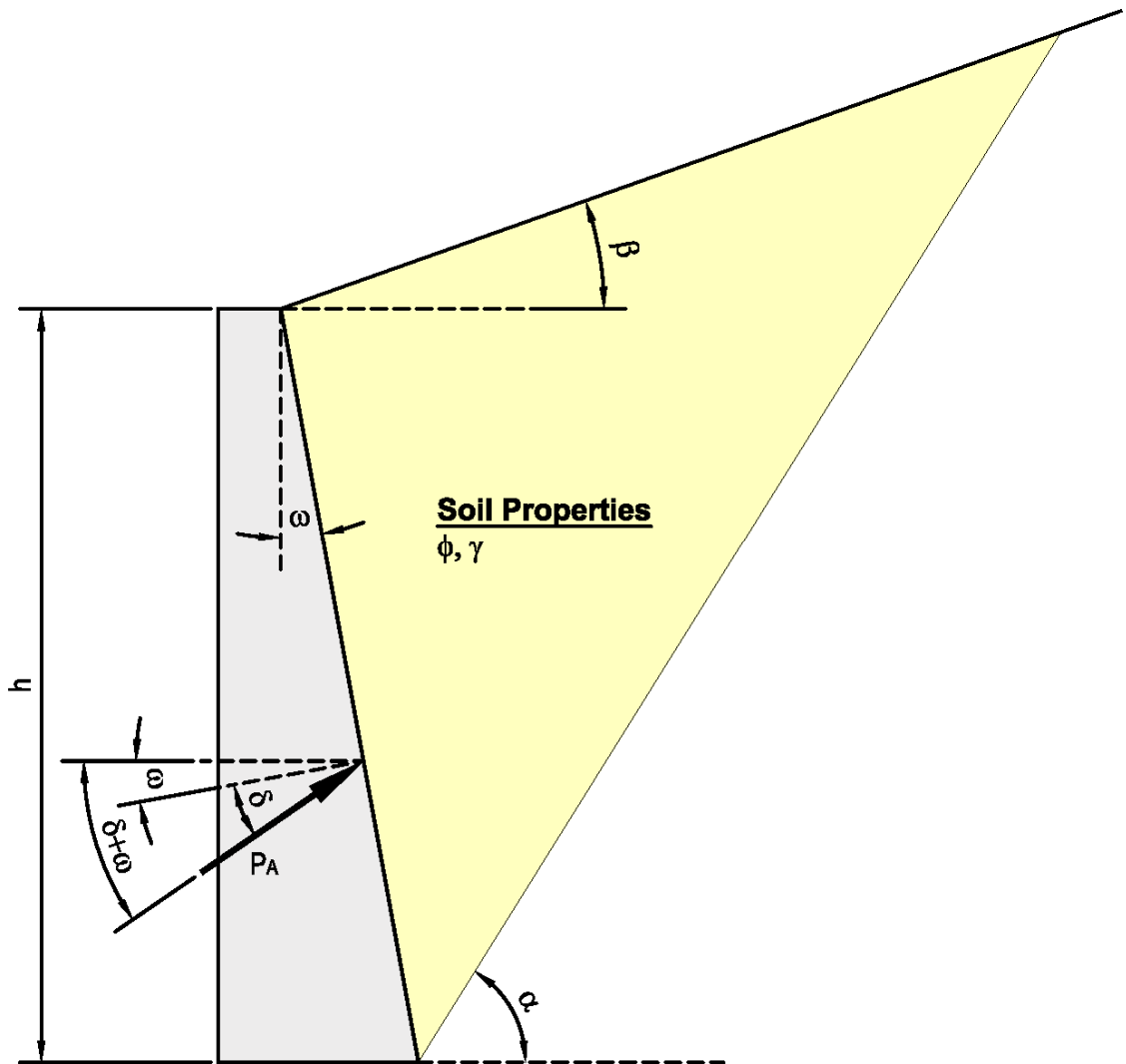

Figure 4-7. Coulomb's active wedge

EARTH PRESSURE THEORY AND APPLICATION

Where:

h = height of pressure surface on the wall.

P_a = active lateral earth pressure resultant per unit width of wall.

P_p = passive lateral earth pressure resultant per unit width of wall.

δ = friction angle between backfill material and face of wall.(See Table 4-2)

β = angle from backfill surface to the horizontal.

α = failure plane angle with respect to the horizontal.

ω = angle from the face of wall to the vertical.

ϕ = effective friction angle of soil.

K_a = coefficient of active lateral earth pressure.

K_p = coefficient of passive lateral earth pressure.

γ = unit weight of soil.

Table 4-2. Wall friction

ULTIMATE FRICTION FACTOR FOR DISSIMILAR MATERIALS

INTERFACE MATERIALS	FRICTION ANGLE, δ (°)
Mass concrete on the following foundation materials:	
• Clean sound rock ·····	35
• Clean gravel, gravel-sand mixtures, coarse sand ·····	29 to 31
• Clean fine to medium sand, silty medium to coarse sand, silty or clayey gravel ·····	24 to 29
• Clean fine sand, silty or clayey fine to medium sand ·····	19 to 24
• Fine sandy silt, nonplastic silt ·····	17 to 19
• Very stiff and hard residual or preconsolidated clay ·····	22 to 26
• Medium stiff and stiff clay and silty clay ·····	17 to 19
Masonry on foundation materials has same friction factors.	
Steel sheet piles against the following soils:	
• Clean gravel, gravel-sand mixtures, well-graded rock fill with spalls ·····	22
• Clean sand, silty sand-gravel mixture, single-size hard rock fill ·····	17
• Silty sand, gravel or sand mixed with silt or clay ·····	14
• Fine sandy silt, nonplastic silt ·····	11
Formed or precast concrete or concrete sheet piling against the following soils:	
• Clean gravel, gravel-sand mixture, well-graded rock fill with spalls ·····	22 to 26
• Clean sand, silty sand-gravel mixture, single-size hard rock fill ·····	17 to 22
• Silty sand, gravel or sand mixed with silt or clay ·····	17
• Fine sandy silt, nonplastic silt ·····	14
Various structural materials:	
• Masonry on masonry, igneous and metamorphic rocks:	
○ dressed soft rock on dressed soft rock ·····	35
○ dressed hard rock on dressed soft rock ·····	33
○ dressed hard rock on dressed hard rock ·····	29
• Masonry on wood in direction of cross grain ·····	26
• Steel on steel at sheet pile interlocks ·····	17
This table is a reprint of Table 3.11.5.3-1, AASHTO LRFD BDS, 4 th ed, 2007	

Further discussion of Wall Friction is included in Section 4.6.

4.4 COHESIVE SOIL

Neither Coulomb's nor Rankine's theories explicitly incorporated the effect of cohesion in the lateral earth pressure computations. Bell (1952) modified Rankine's solution to include the effect of the backfill with cohesion. The derivation of Bell's equations for the active and passive earth pressure follows the same steps as were used in Section 4.3 as shown below.

For the cohesive soil Figure 4-9 can be used to derive the relationship for the active and passive earth pressures.

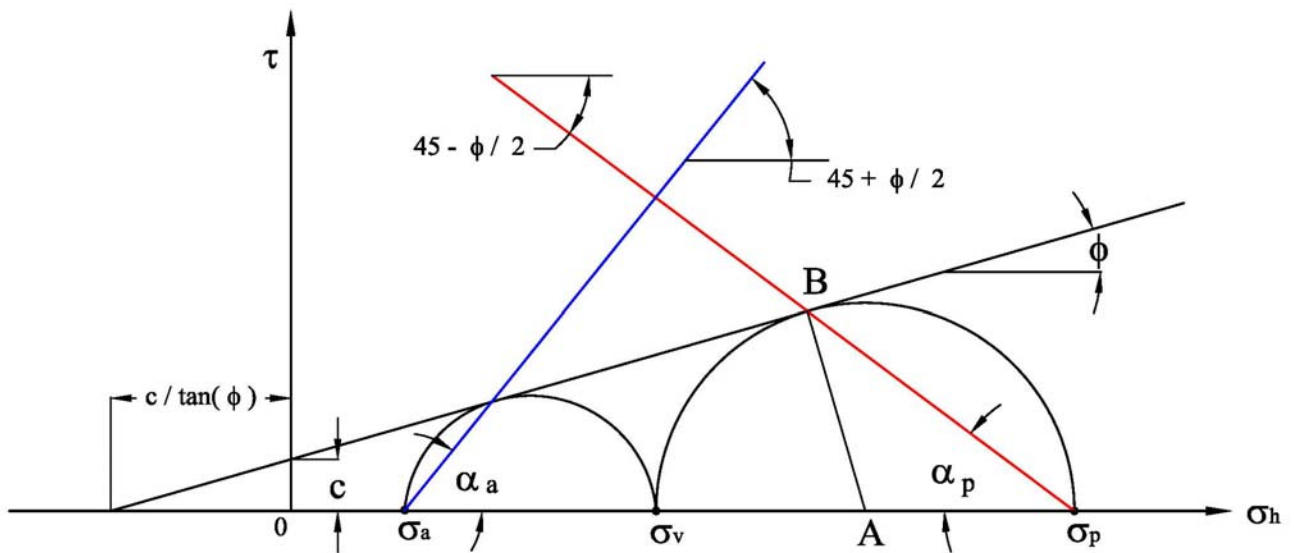

Figure 4-9. Mohr Circle Representation of Earth Pressure for Cohesive Backfill

For the Active case:

$$\sin \phi = \frac{\frac{\sigma_v - \sigma_a}{2}}{\frac{\sigma_v + \sigma_a}{2} + \frac{c}{\tan \phi}} \quad \text{Eq. 4-24}$$

Then,

$$\sigma_v \sin \phi + \sigma_a \sin \phi + 2c(\cos \phi) = \sigma_p - \sigma_a \quad \text{Eq. 4-25}$$

Collecting Terms:

$$\sigma_v(1 - \sin \phi) = \sigma_a(1 + \sin \phi) + 2c(\cos \phi) \quad \text{Eq. 4-26}$$

Solving for σ_a

$$\sigma_a = \frac{\sigma_v(1 - \sin \phi)}{(1 + \sin \phi)} - \frac{2c(\cos \phi)}{(1 + \sin \phi)} \quad \text{Eq. 4-27}$$

Using the trigonometric identities from above:

$$\sigma_a = \sigma_v \tan^2\left(45 - \frac{\phi}{2}\right) - 2c \tan\left(45 - \frac{\phi}{2}\right) \quad \text{Eq. 4-28}$$

$$\sigma_a = \sigma_v K_a - 2c\sqrt{K_a}, \text{ where } \sigma_v = \gamma z \quad \text{Eq. 4-29}$$

For the passive case:

Solving for σ_p

$$\sigma_p = \frac{\sigma_v(1 + \sin \phi)}{(1 - \sin \phi)} + \frac{2c(\cos \phi)}{(1 - \sin \phi)} \quad \text{Eq. 4-30}$$

$$\sigma_p = \sigma_v \tan^2\left(45 + \frac{\phi}{2}\right) + 2c \tan\left(45 + \frac{\phi}{2}\right) \quad \text{Eq. 4-31}$$

$$\sigma_p = \sigma_v K_p - 2c\sqrt{K_p}, \text{ where } \sigma_v = \gamma z \quad \text{Eq. 4-32}$$

Extreme caution is advised when using cohesive soil to evaluate soil stresses. The evaluation of the stress induced by cohesive soils is highly uncertain due to their sensitivity to shrinkage-swell, wet-dry and degree of saturation. Tension cracks (gaps) can form, which may considerably alter the assumptions for the estimation of stress. The development of the tension cracks from the surface to depth, h_{cr} , is shown in Figure 4-10.

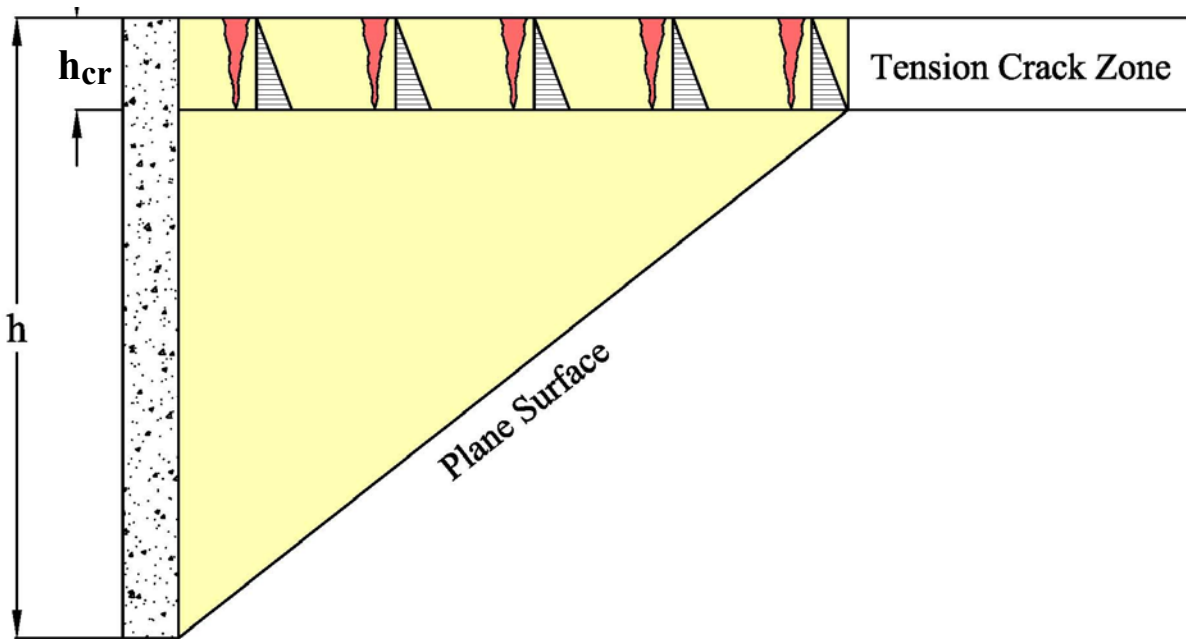

Figure 4-10. Tension crack with hydrostatic water pressure

EARTH PRESSURE THEORY AND APPLICATION

As shown in Figure 4-11, the active earth pressure (σ_a) normal to the back of the wall at depth, h , is equal to:

$$\sigma_a = \gamma h K_a - 2C\sqrt{K_a} \quad \text{Eq. 4-33}$$

$$P_a = \frac{1}{2}\gamma h^2 K_a - 2C\sqrt{K_a}(h) \quad \text{Eq. 4-34}$$

According to Eq. 4-33 the lateral stress (σ_a) at some point along the wall is equal to zero, therefore,

$$\gamma h K_a - 2C\sqrt{K_a} = 0 \quad \text{Eq. 4-35}$$

$$h = h_{cr} = \frac{2C\sqrt{K_a}}{\gamma K_a} \quad \text{Eq. 4-36}$$

As shown in Figure 4-11, the passive earth pressure (σ_p) normal to the back of the wall at depth, h , is equal to:

$$\sigma_p = \gamma h K_p + 2C\sqrt{K_p} \quad \text{Eq. 4-37}$$

$$P_p = \frac{1}{2}\gamma h^2 K_p + 2C\sqrt{K_p}(h) \quad \text{Eq. 4-38}$$

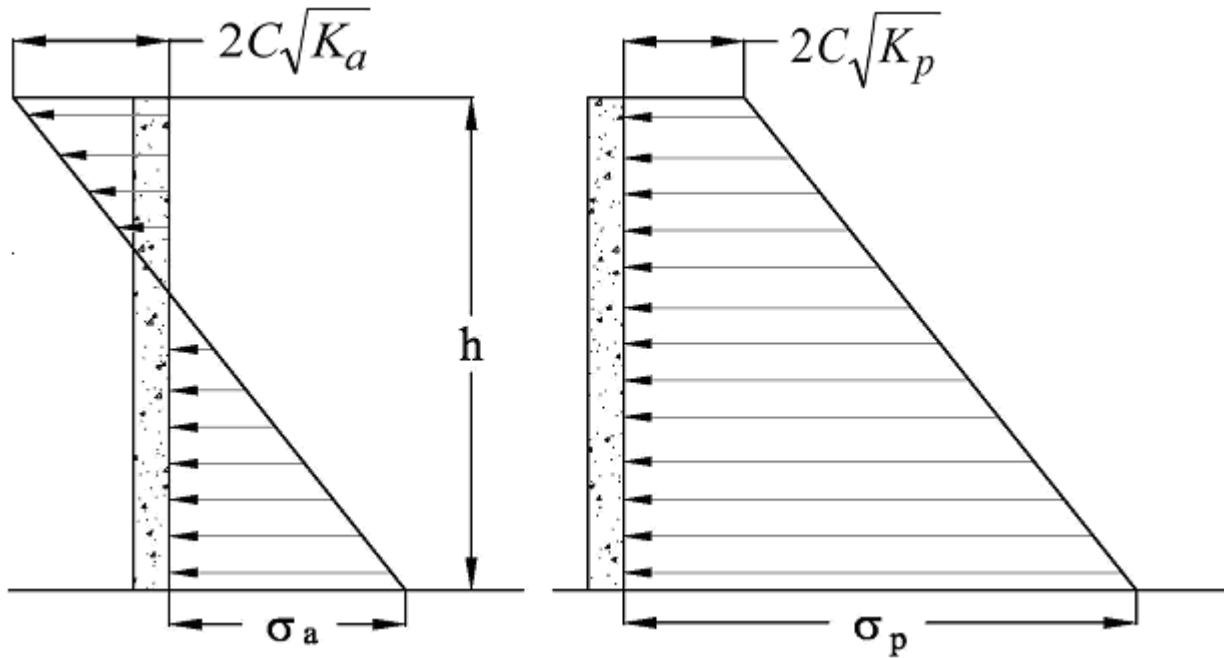

Figure 4-11. Cohesive Soil Active Passive Earth Pressure Distribution

The effect of the surcharges and ground water are not included in the above figure. In the presence of water, the hydrostatic pressure in the tension crack needs to be considered.

For shoring systems which support cohesive backfill, the height of the tension zone, h_{cr} , should be ignored and the simplified lateral earth pressure distribution acting along the entire wall height, h , including presence of water pressure within the tension zone as shown in Figure 4-12 shall be used.

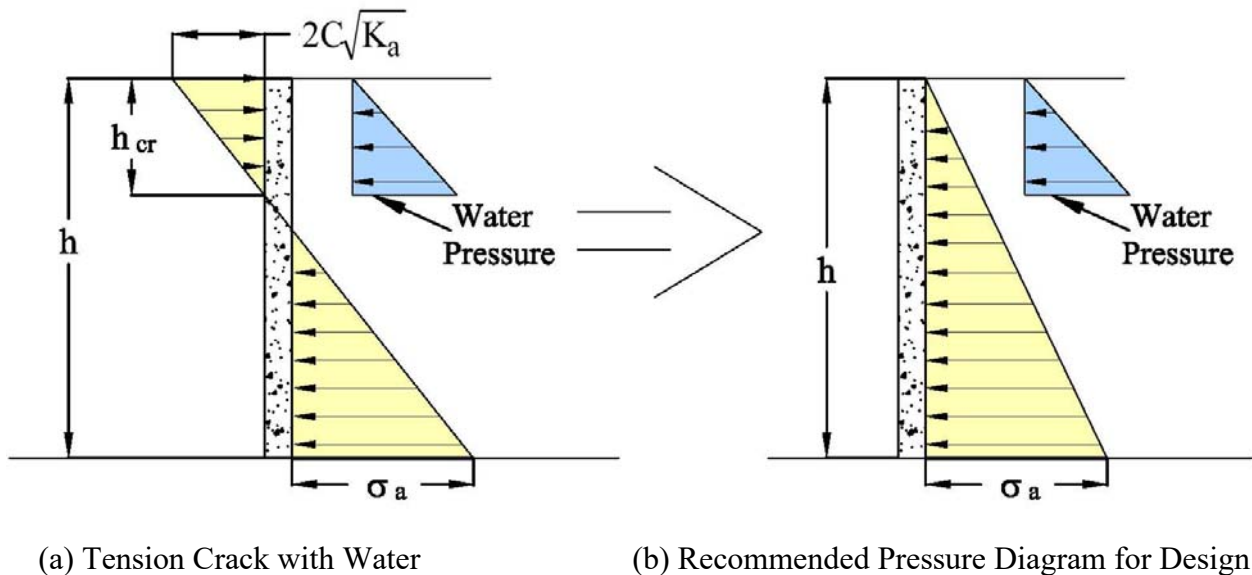

Figure 4-12: Load Distribution for Cohesive Backfill

The apparent active earth pressure coefficient, $K_{apparent}$, may be determined by:

$$K_{apparent} = \frac{\sigma_a}{\gamma h} \geq 0.25 \quad \text{Eq. 4-39}$$

Where: (for Eq. 4-24 through Eq. 4-39)

- h = height of pressure surface at back of wall.
- P_a = active lateral earth pressure resultant per unit width of wall.
- P_p = passive lateral earth pressure resultant per unit width of wall.
- ϕ = effective friction angle of soil.
- C = effective soil cohesion.
- K_a = coefficient of active lateral earth pressure.
- K_p = coefficient of passive lateral earth pressure.
- γ = unit weight of soil.
- h_{cr} = height of the tension crack.

EARTH PRESSURE THEORY AND APPLICATION

The active lateral earth pressure (σ_a) acting over the wall height, h , should not be less than 0.25 times the effective vertical stress ($\sigma_v = \gamma h$) at any depth. Any design based on a lower value must have superior justification such as multiple laboratory tests verifying higher values for "C", as well as time frames and other conditions that would not affect the cohesive value while the shoring is in place.

4.5 SHORING SYSTEMS AND SLOPING GROUND

There are many stable slopes in nature even though the slope angle β is larger than the soil friction angle ϕ due to presence of cohesion C . None of the earth pressure theories will work when the slope angle β is larger than friction angle ϕ even if the shoring system is to be installed in cohesive soil. Mohr Circle representation of the C - ϕ soil backfill with slope angle $\beta > \phi$ is shown in Figure 4-13.

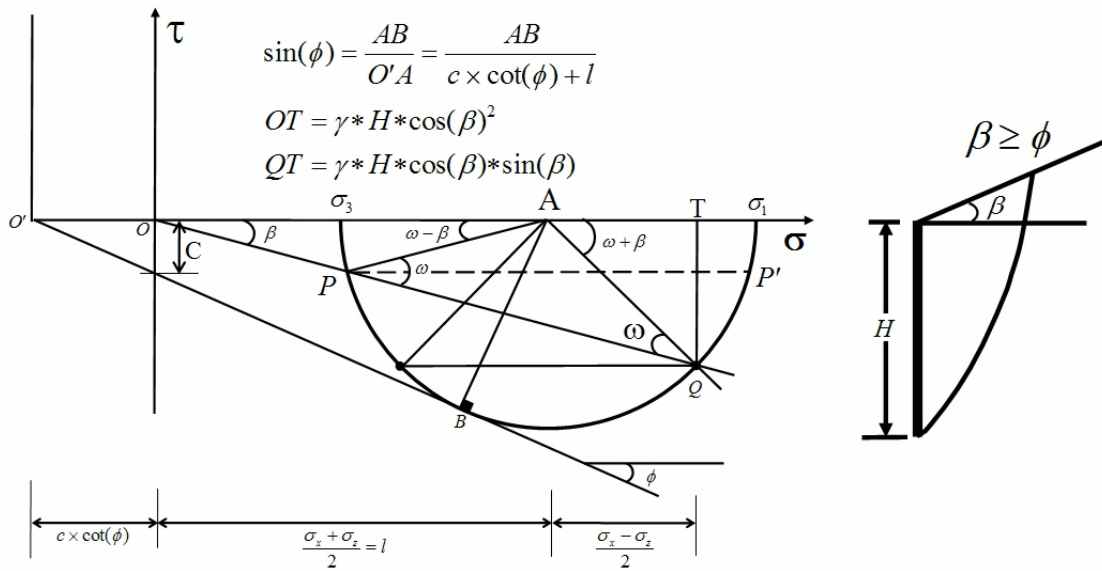

Figure 4-13. Sloping Ground

The following equations developed by the authors are based on ASCE Journal of Geotechnical and Geoenvironmental Engineering (February 1997) and are used to solve this problem.

$$\sin \beta \leq \sin \phi + \frac{c}{l} \cos \phi \tag{Eq. 4-40}$$

Where:

$$l = \frac{1}{\cos \phi^2} \left[\sigma_x + \frac{1}{2} \sin(2\phi) - \sqrt{\sigma_v (\cos \beta^2 - \cos \phi^2) + \sigma_x [c \sin(2\phi)] + c^2 \cos \phi^2} \right] \tag{Eq. 4-41}$$

$$\sigma_v = \gamma (H \cos \beta)$$

$$\sigma_x = \gamma (H \cos^2 \beta)$$

The following outlines various methods for analyzing shoring systems that have sloping ground conditions.

4.5.1 Active Trial Wedge Method

Figure 4-14 shows the assumptions used to determine the resultant active pressure for sloping ground with an irregular backfill condition applying the wedge theory. This is an iterative process. The failure plane angle (α_n) for the wedge varies until the maximum value of the active earth pressure is computed using Eq. 4-42. The development of Eq. 4-42 is based on the limiting equilibrium for a general soil wedge. It is assumed that the soil wedge moves downward along the failure surface and along the wall surface to mobilize the active wedge. This wedge is held in equilibrium by the resultant force equal to the resultant active pressure (P_a) acting on the face of the wall. Since the wedge moves downward along the face of the wall, this force acts with an assumed wall friction angle (δ) below the normal to the wall to oppose this movement.

For any assumed failure surface defined by angle α_n from the horizontal and the length of the failure surface L_n , the magnitude of the wedge weight (W_n) is the weight of the soil wedge plus the relevant surcharge load. For any failure wedge the maximum value of P_a can be determined using Eq. 4-42.

$$P_a = \frac{W[\tan(\alpha - \phi)] - C_o L_c [\sin \alpha \tan(\alpha - \phi) + \cos \alpha] - C_a L_a [\tan(\alpha - \phi) \cos(-\omega) + \sin \omega]}{[1 + \tan(\delta + \omega) \tan(\alpha - \phi)] \cos(\delta + \omega)}$$

Eq. 4-42

4.5.2 Passive Trial Wedge Method

Figure 4-15 shows the assumptions used to determine the resultant passive pressure for a broken back slope condition applying the trial wedge theory. Using the limiting equilibrium for a given wedge, Eq. 4-43 calculates the passive earth pressure on a wall. The same iterative procedure is used as was used for the active case. However, the failure surface angle (α_n) is varied until the minimum value of passive pressure P_p is attained.

$$P_p = \frac{W [\tan(\alpha + \phi)] + C_o L_c [\sin \alpha \tan(\alpha + \phi) + c \cos \alpha] + C_a L_a [\tan(\alpha + \phi) \cos(-\omega) + \sin \omega]}{[1 - \tan(\delta + \omega) \tan(\alpha + \phi)] \cos(\delta + \omega)}$$

Eq. 4-43

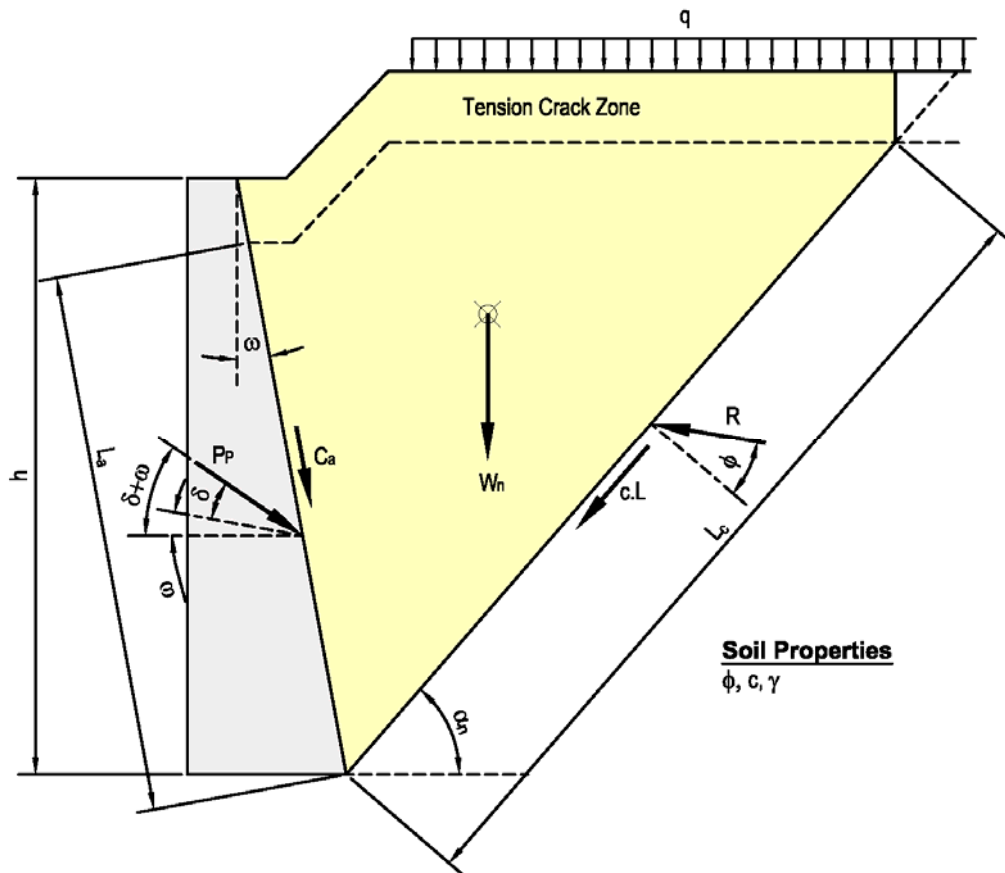

Figure 4-15. Passive Trial Wedge

Where:

P_p = passive lateral earth pressure resultant per unit width of wall.

W_n = weight of soil wedge plus the relevant surcharge loads.

δ = friction angle between backfill material and back of wall.

ϕ = effective friction angle of soil.

α_n = failure plane angle with respect to horizontal.

C = soil cohesion.

L_n = length of the failure plane.

4.5.3 Culmann's Graphical Solution for Active Earth Pressure

Culmann (1866) developed a convenient graphical solution procedure to calculate the active earth pressure for retaining walls for irregular backfill and surcharges. Figure 4-16 shows a failure wedge and a force polygon acting on the wedge. The forces per unit width of the wall to be considered for equilibrium of the wedge are as follows:

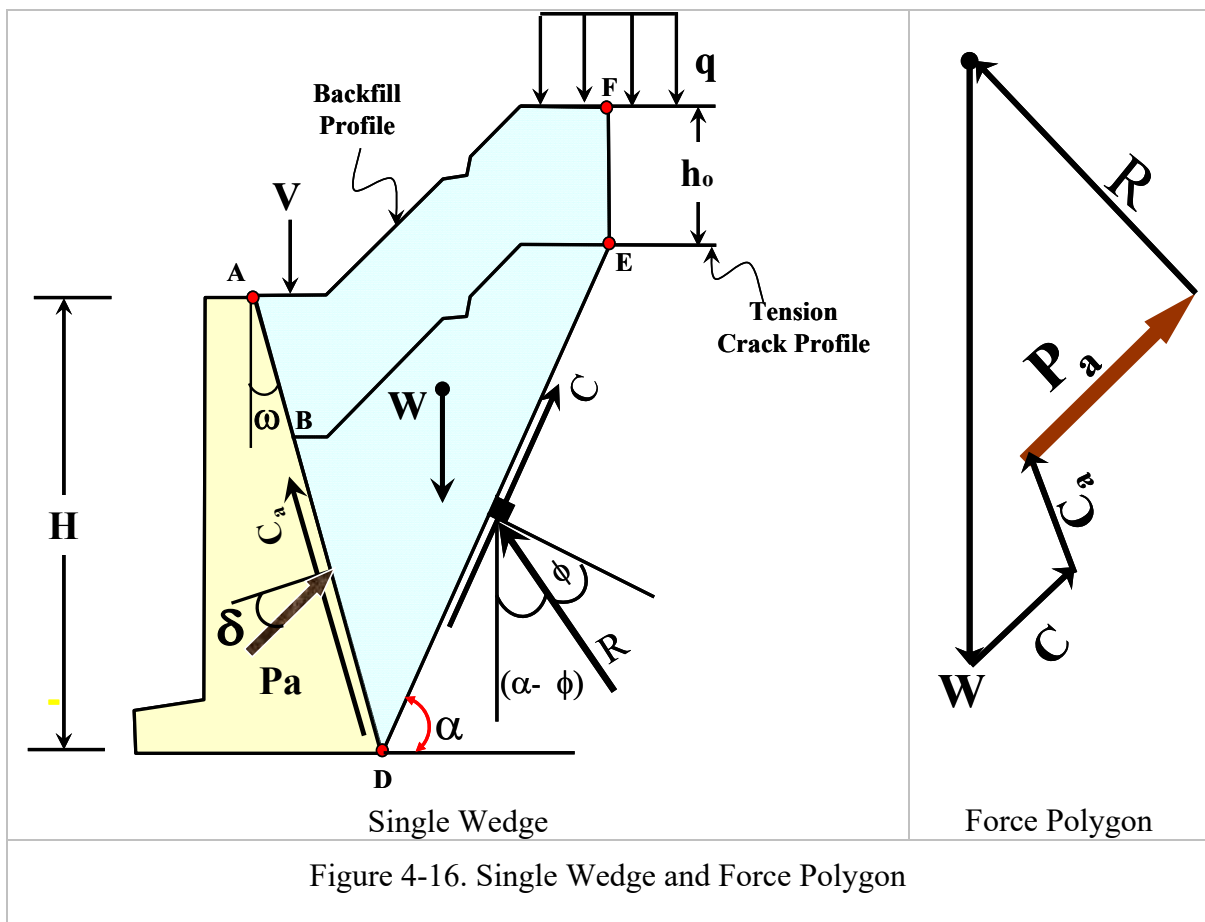

EARTH PRESSURE THEORY AND APPLICATION

1. W = Weight of the wedge including weight of the tension crack zone and the surcharges with a known direction and magnitude

$$W = \text{ABDEFA}_{\text{area}} (\gamma) + q(lq) + V \quad \text{Eq. 4-44}$$

2. C_a = Adhesive force along the backfill of the wall with a known direction and magnitude

$$C_a = c (\text{BD}) \quad \text{Eq. 4-45}$$

3. C = Cohesive force along the failure surface with a known direction and magnitude

$$C = c (\text{DE}) \quad \text{Eq. 4-46}$$

4. h_o = Height of the tension crack

$$h_o = \frac{2C\sqrt{K_a}}{g(K_a)}; \text{ Where } K_a = \tan^2\left(45 - \frac{\phi}{2}\right) \quad \text{Eq. 4-47}$$

5. R = Resultant of the shear and normal forces acting on the failure surface DE with the direction known only

6. P_a = Active force of wedge with the direction known only

Where:

c = Soil cohesion value.

K_a = Rankine active earth pressure coefficient.

ϕ = Soil friction angle.

γ = Unit weight of soil.

To determine the maximum active force against a retaining wall, several trial wedges must be considered and the force polygons for all the wedges must be drawn to scale as shown Figure 4-17.

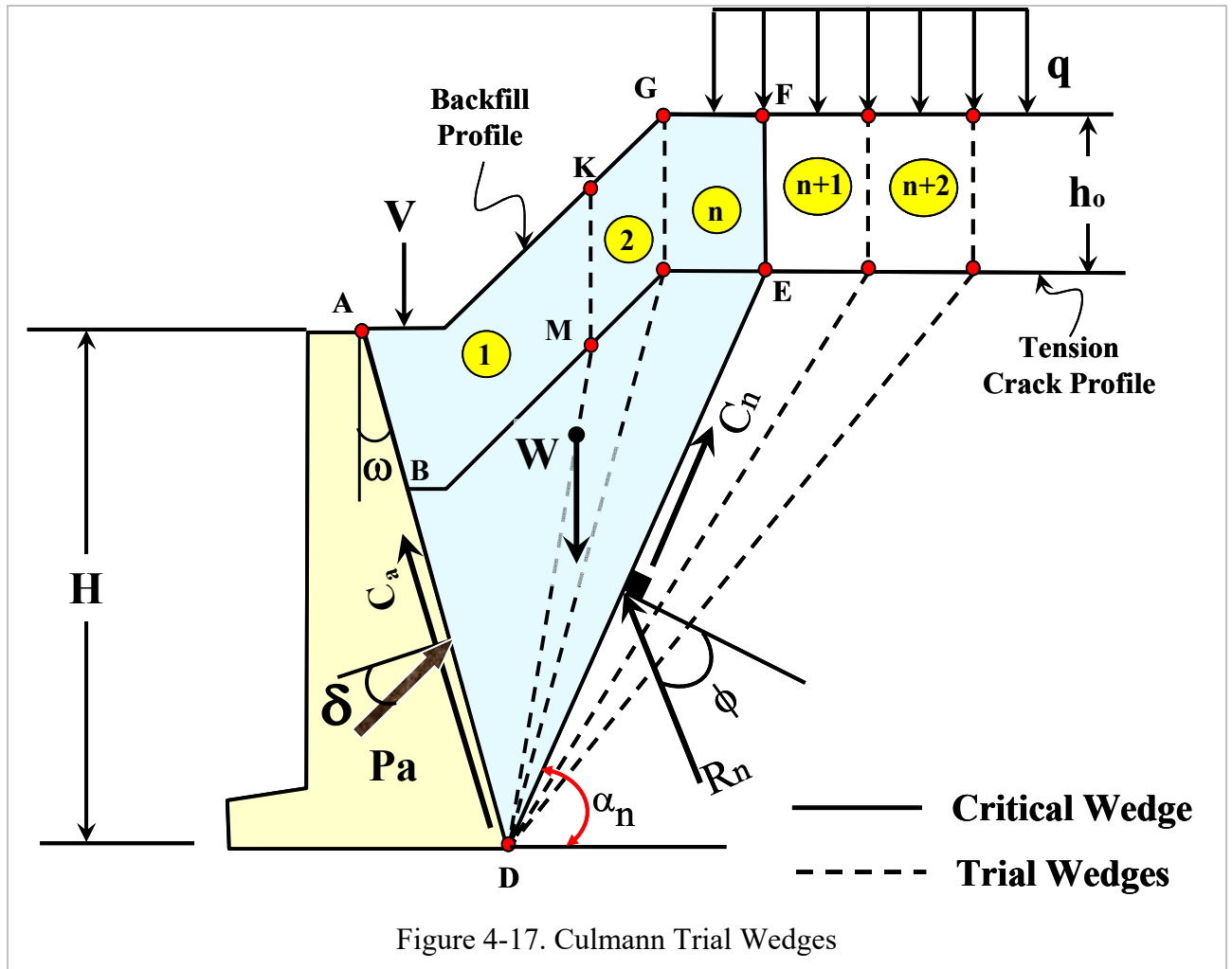

Figure 4-17. Culmann Trial Wedges

The procedure for estimating the maximum active force, P_a , as shown in Figure 4-17 and Figure 4-18, is described as follows:

1. Draw the lines for the tensile crack profile parallel to the backfill profile with height equal to h_0 .
2. Draw several trial wedges to intersect the tension crack profile line.
3. Draw the vectors to represent the weight of wedges per unit width of the wall including the surcharges.
4. Draw adhesion force vector C_a acting along the face of the wall.
5. Draw cohesion force vector C_{oh} acting along the failure surfaces.
6. Draw the active force vector P_a .
7. Draw the resultant force vector R acting on the failure place
8. Repeat steps 2 through 7 until all trial wedges are complete

EARTH PRESSURE THEORY AND APPLICATION

9. Draw a smooth curve through these points as shown in Figure 4-18. A cubic spline function is used in CT-Flex computer program to draw the smooth line between point P_1 through point P_{n+2} as shown in Figure 4-18.
10. Draw dashed line TT' through the left end of force vectors P_a as shown in Figure 4-18.

Draw a parallel line to line TT' that is tangent to the above curve to measure maximum active earth pressure length as shown in Figure 4-18.
12. Draw a line parallel to the force vectors P_a that begins at TT' and ends at the intersection point of the tangent line to the curved line above. This is the maximum active pressure force vector $P_{a_{max}}$.

The maximum active pressure shown in Figure 4-17 and Figure 4-18 is obtained as:

$$P_a = (\text{length of } L) \times (\text{load scale } \lambda)$$

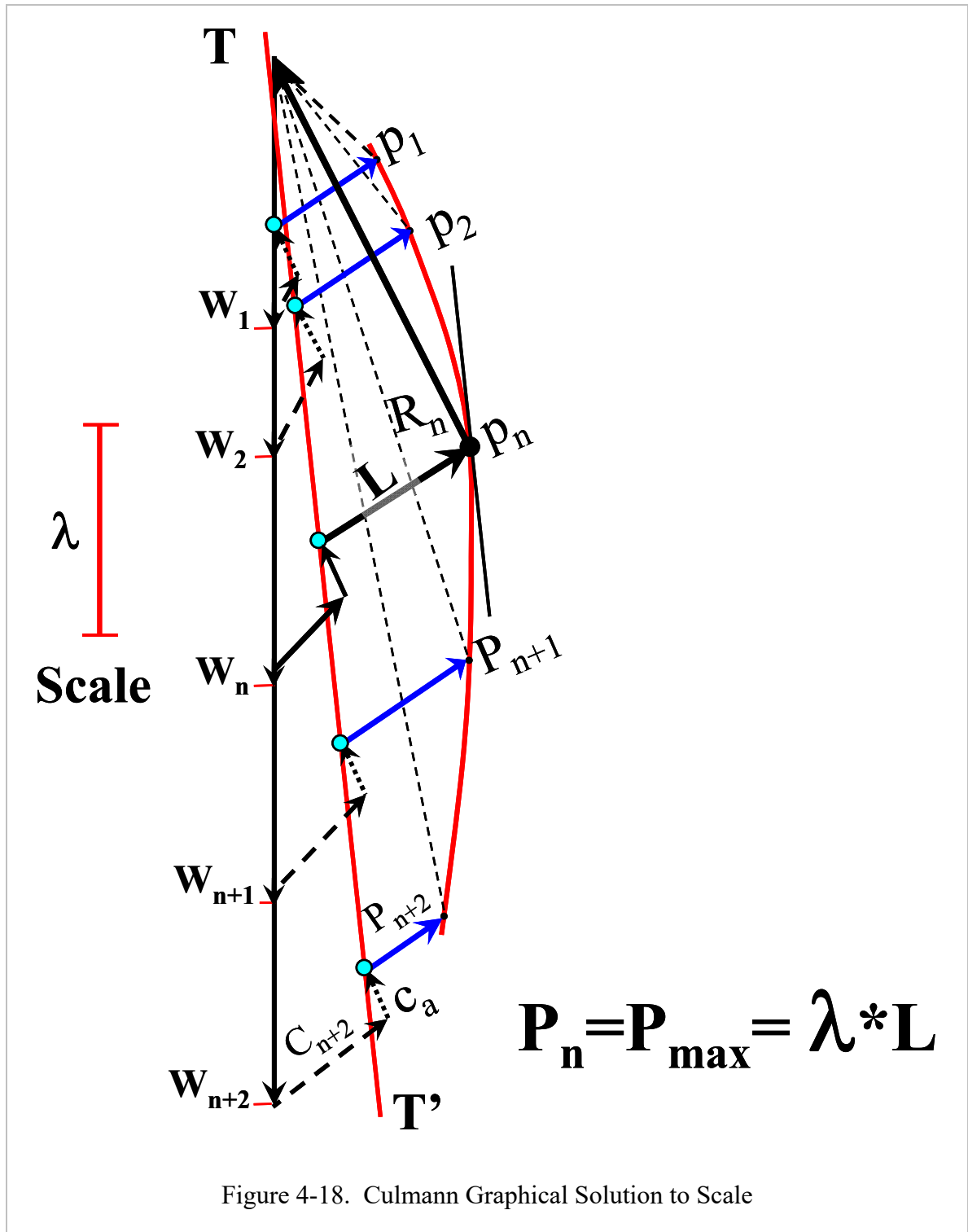
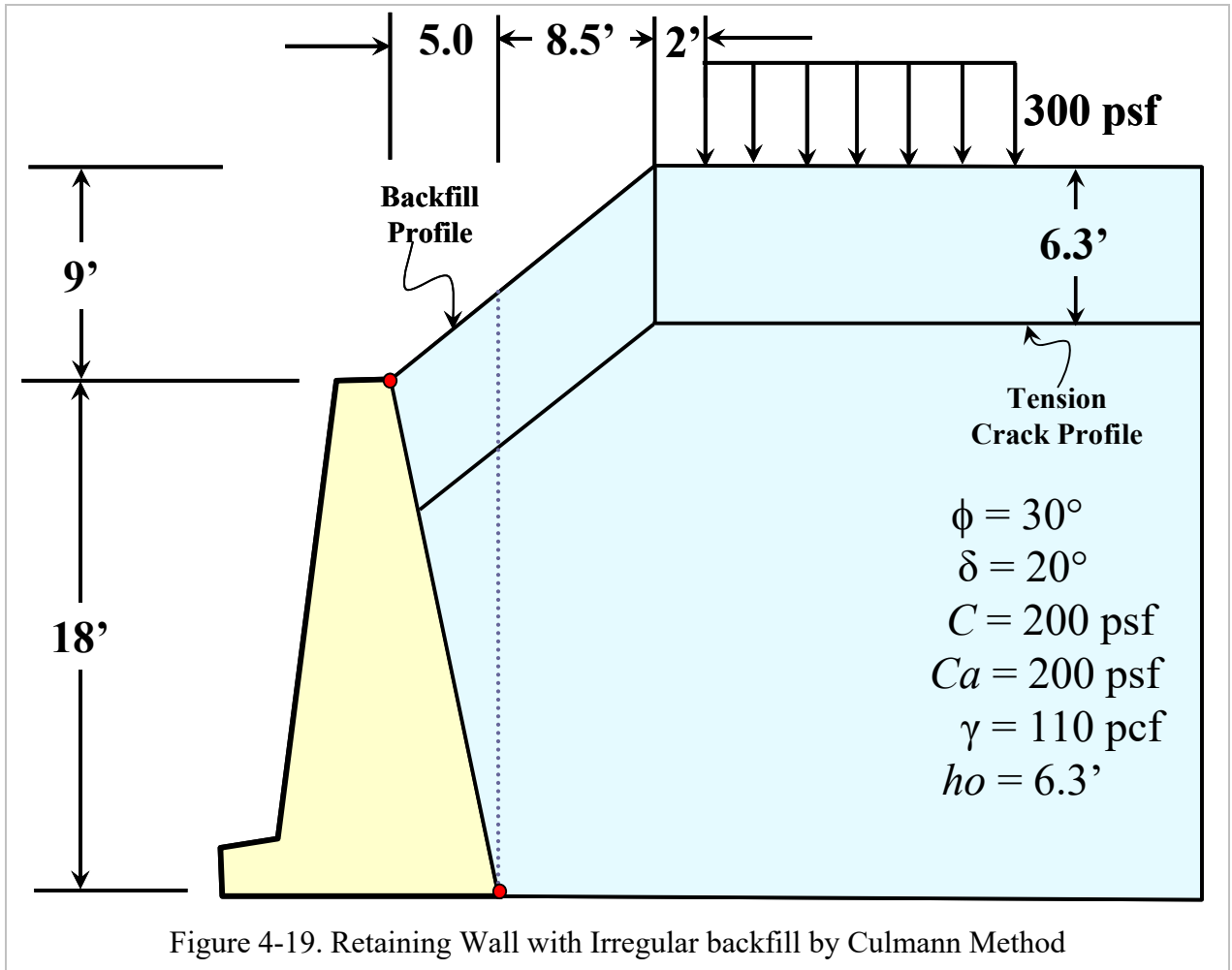

Figure 4-18. Culmann Graphical Solution to Scale

4.5.3.1 Example 4-1 Culmann Graphical Method

Calculate the maximum active earth pressure using the Culmann graphical method for a retaining wall given in Figure 4-19 using the following backfill properties.



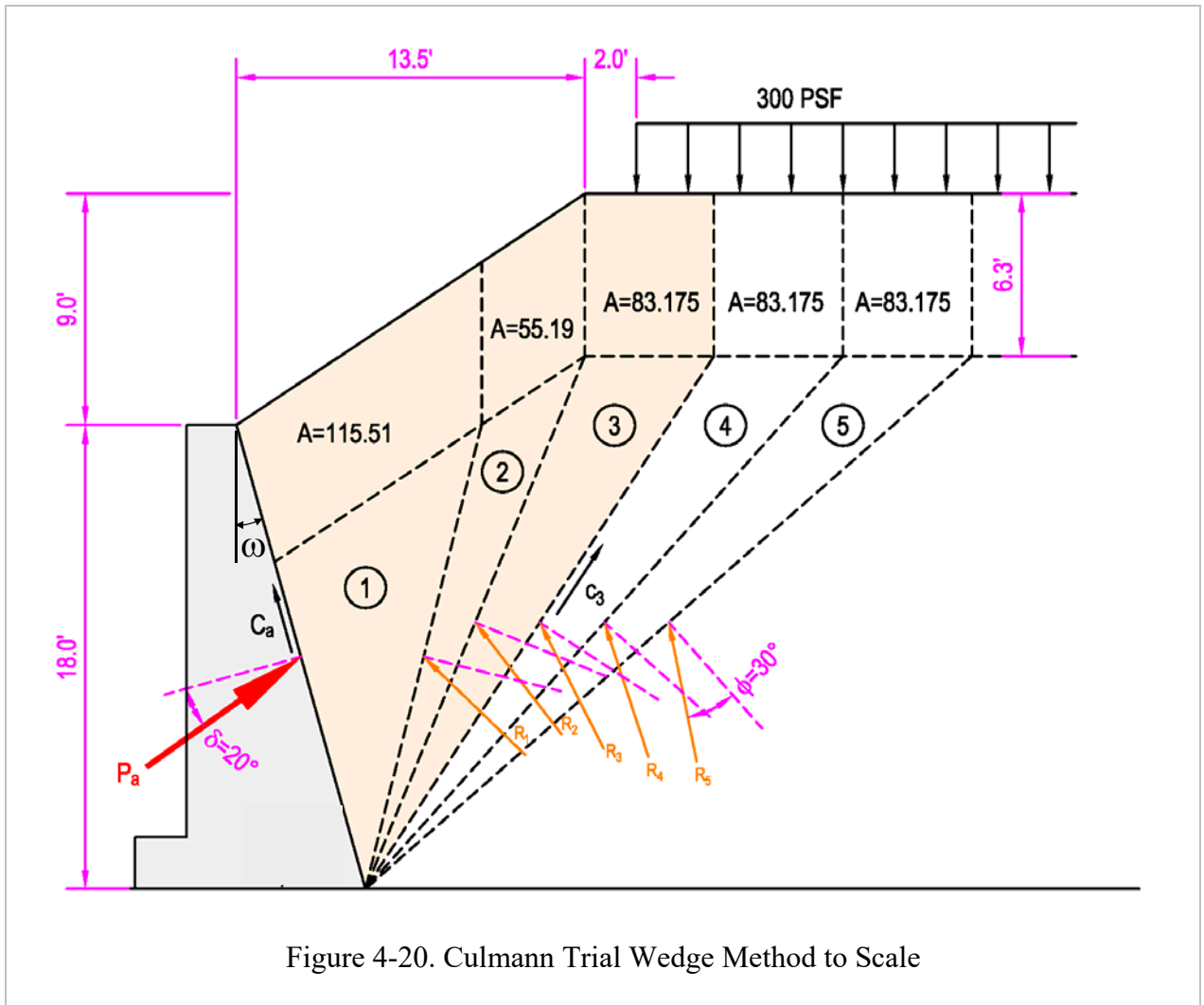

Figure 4-20. Culmann Trial Wedge Method to Scale

Solution:

As shown in Figure 4-20 several trial wedges are drawn. The weight of each of these wedges, the adhesive force at the wall interface and cohesive force along the failure surface are computed as is shown below.

The active earth pressure due to soil-wall interaction is constant for all wedges and is calculated as shown below.

$$\text{Determine wall angle: } \omega = \tan^{-1}\left(\frac{5'}{18'}\right) = 15.52^\circ$$

$$L_a = \frac{(18 - 6.3)}{\cos(15.52)} = 12.14 \text{ ft.}$$

$$C_a = c_a L_a = (2)(12.14) = 2.43 \text{ k/ft}$$

EARTH PRESSURE THEORY AND APPLICATION

Where L_a is the length of the active wedge along the backwall and C_a is the active earth pressure due to wall-backfill adhesion properties.

Table 4-3. Culmann Graphical Method Results

Geometry			Weight Components				Cohesion Comp.		
Wedge	Backfill Profile Coordinates		Wt (k)	Σ Wt (k)	Sur. Wt (k)	Σ Sur. (k)	Total Wt (k)	Length (ft)	Coh (k)
	X	Y							
1	4.51	18.04	12.72	12.72	0	0	12.72	18.6	3.72
2	8.51	20.70	6.09	18.81	0	0	18.81	22.38	4.48
3	13.52	20.70	9.17	27.98	0.91	0.91	28.89	24.72	4.94
4	18.53	20.70	9.17	37.15	1.50	2.41	39.56	27.78	5.56
5	23.54	20.70	9.18	46.33	1.50	3.91	50.24	31.34	6.27

The force polygon for all the wedges and maximum active force using scaling factors are shown in Figure 4-21. The maximum earth pressure is about 8.5 kips/ft.

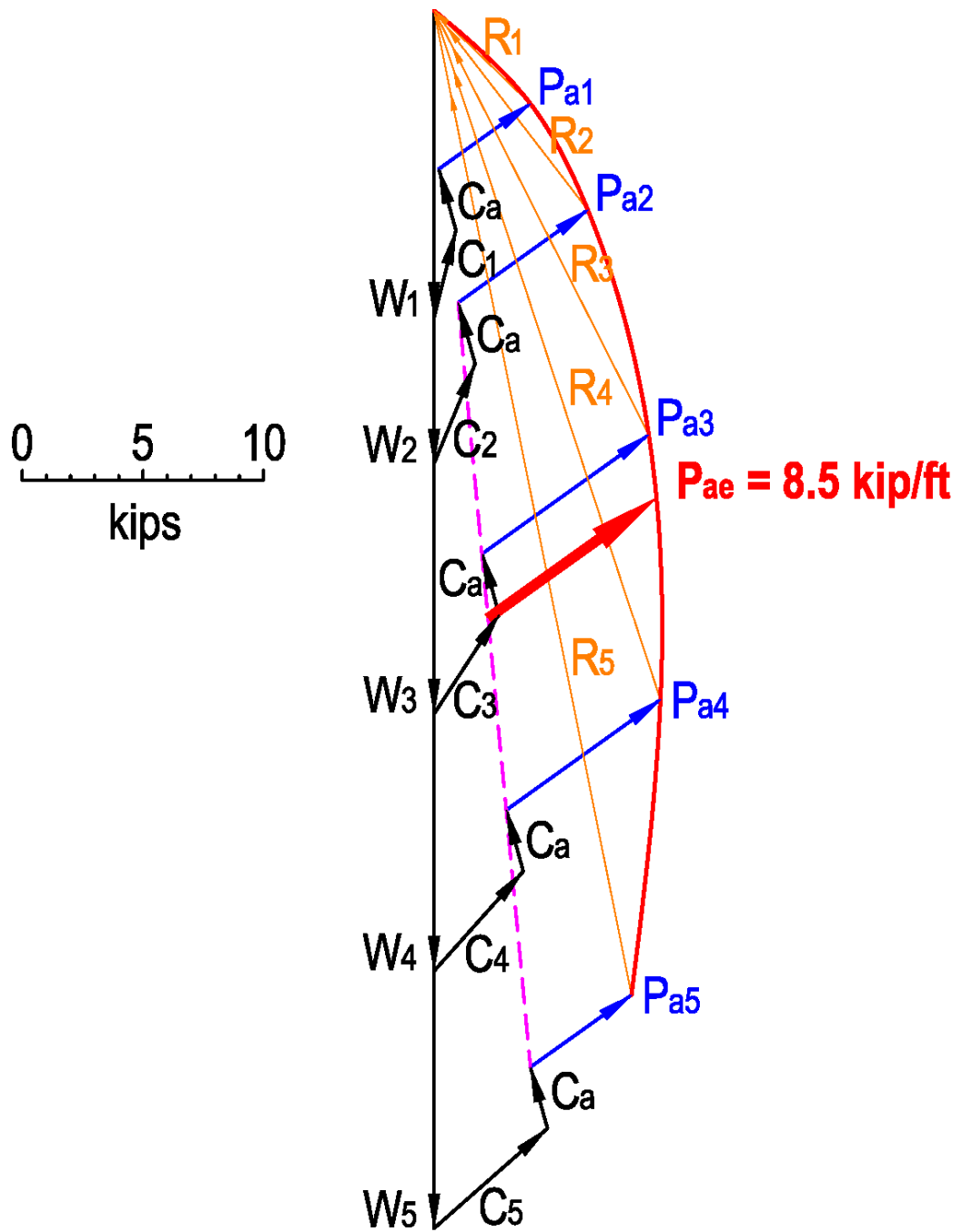
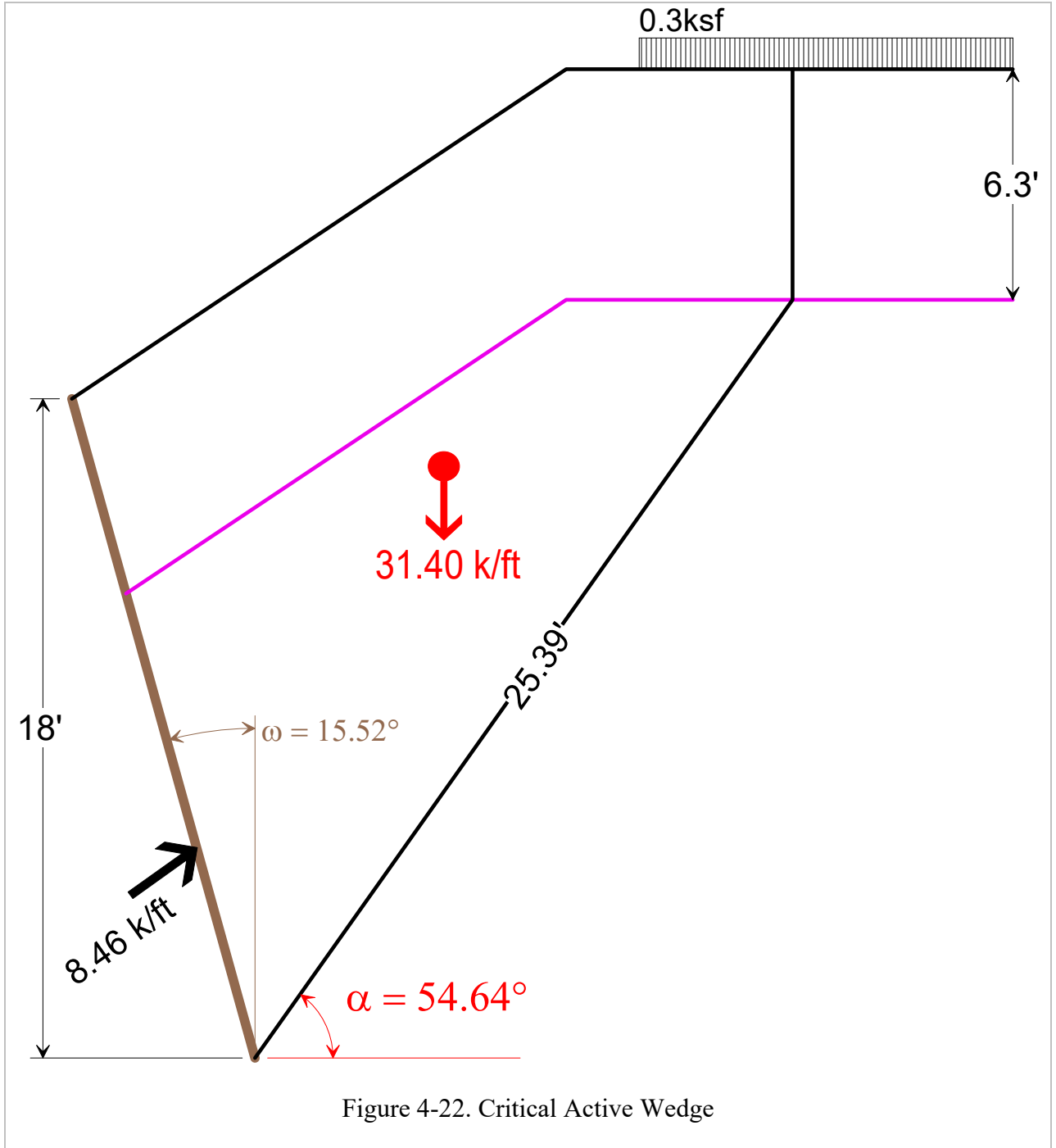

Figure 4-21. Culmann Graphical Solution Using Force Polygon

4.5.3.2 Example 4-2 Trial Wedge Method

Repeat Example 4-1 using trial wedge method. Figure 4-22 illustrates the most critical failure surface developed using the Caltrans Trenching and Shoring Check Program.



Eq. 4-42 is used to calculate the active earth pressure.

$$P_a = \frac{W[\tan(\alpha - \phi)] - C_o L_c [\sin \alpha \tan(\alpha - \phi) + \cos \alpha] - C_a L_a [\tan(\alpha - \phi) \cos(-\omega) + \sin \omega]}{[1 + \tan(\delta + \omega) \tan(\alpha - \phi)] \cos(\delta + \omega)}$$

CT-T&S Program is used to calculate the failure plane angle (α) and the length of the critical failure surface (L_c).

$$P_a = \frac{WT - COH - ADH}{[1 + \tan(\delta + \omega) \tan(\alpha - \phi)] \cos(\delta + \omega)} \quad P1-1$$

Calculate the weight contribution from weight of the wedge and weight the surcharge (WT):

$$WT = W[\tan(\alpha - \phi)] = (31.40)[\tan(54.64 - 30)] = 14.40 \text{ k/ft}$$

Calculate adhesion (ADH) component.

$$L_a = \frac{(18 - 6.3)}{\cos(15.52)} = 12.14 \text{ ft.}$$

$$\begin{aligned} ADH &= C_a L_a [\tan(\alpha - \phi) \cos(-\omega) + \sin(-\omega)] \\ &= (0.2)(12.14)[\tan(54.64 - 30) \cos(-15.52) + \sin(-15.52)] = 0.422 \text{ k/ft} \end{aligned}$$

Calculate cohesion (COH) component.

$$\begin{aligned} COH &= C_o L_c [\sin \alpha \tan(\alpha - \phi) + \cos \alpha] \\ &= (0.2)(25.39)[\sin(54.64) \tan(54.64 - 30) + \cos(54.64)] = 4.837 \text{ k/ft} \end{aligned}$$

Substitute WT, COH and ADH in to P1-1.

$$P_a = \frac{14.40 - 4.84 - .422}{[1 + \tan(20 + 15.52) \tan(54.64 - 30)] \cos(20 + 15.52)} = 8.46 \text{ k/ft}$$

EARTH PRESSURE THEORY AND APPLICATION

The following examples are taken from AREMA (American Railway Engineering and Maintenance-of-Way Association) Manual for Railway Engineering.

4.5.3.3 Example 4-3 (AREMA Manual page 8-5-12)

Calculate the maximum active earth pressure using the Culmann graphical method for a retaining wall with a heel (earth pressure at line AB) given in Figure 4-23.

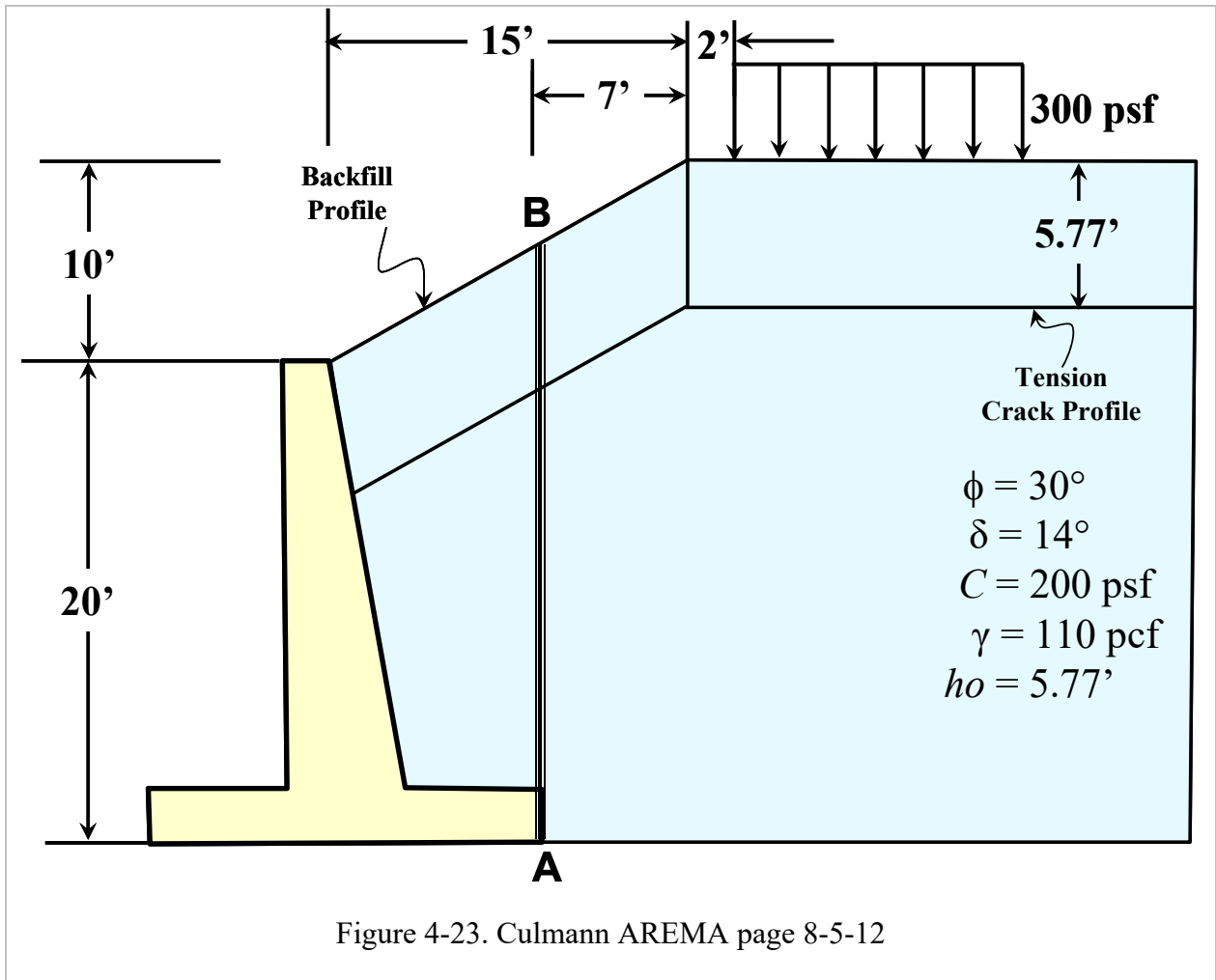

Figure 4-23. Culmann AREMA page 8-5-12

Solution:

As shown in Figure 4-24 several trial wedges are drawn. The weight of each of these wedges, the adhesive force at the wall interface and cohesive force along the failure surface are computed as is shown below.

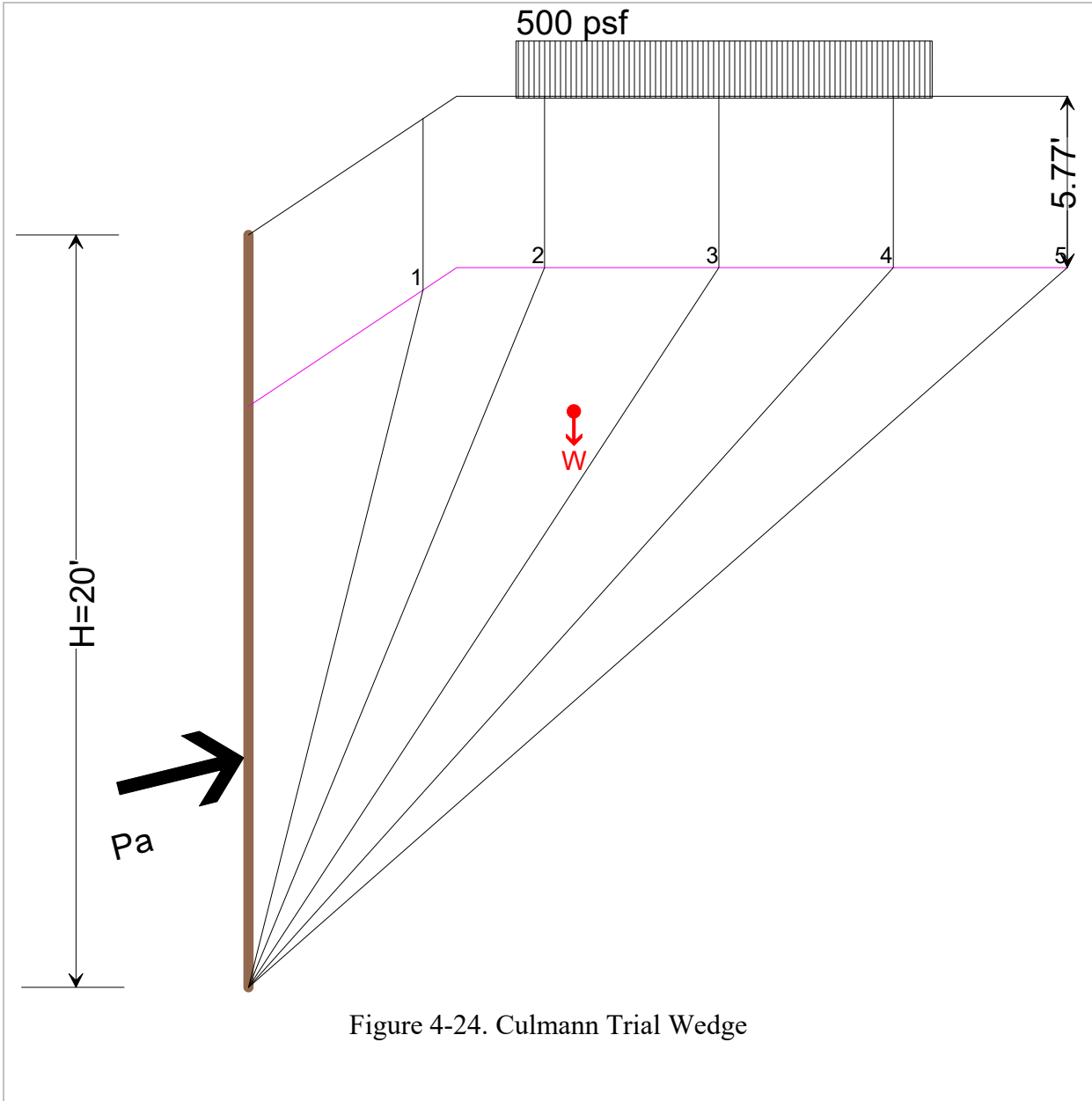

Figure 4-24. Culmann Trial Wedge

EARTH PRESSURE THEORY AND APPLICATION

Table 4-4. Culmann Trial Wedge Method Results

Geometry			Weight Components				Cohesion Comp.		
Wedge	Backfill Profile Coordinates		Wt (k)	Σ Wt (k)	Sur. Wt (k)	Σ Sur. (k)	Total Wt (k)	Length (ft)	Coh (k)
	X	Y							
1	5.87	23.48	10.95	10.95	0	0	10.95	24.20	4.84
2	9.96	24.23	8.47	19.42	0.48	0.48	19.90	26.20	5.24
3	15.83	24.23	12.58	32.00	2.93	3.41	35.41	28.94	5.79
4	21.69	24.23	12.58	44.58	2.93	6.34	50.92	32.52	6.50
5	27.55	24.23	12.58	57.16	0.66	7.00	64.16	36.69	7.34

The force polygon for all the wedges and maximum active force using scaling factors are shown in Figure 4-25. The maximum earth pressure is about 11.35 kips/ft.

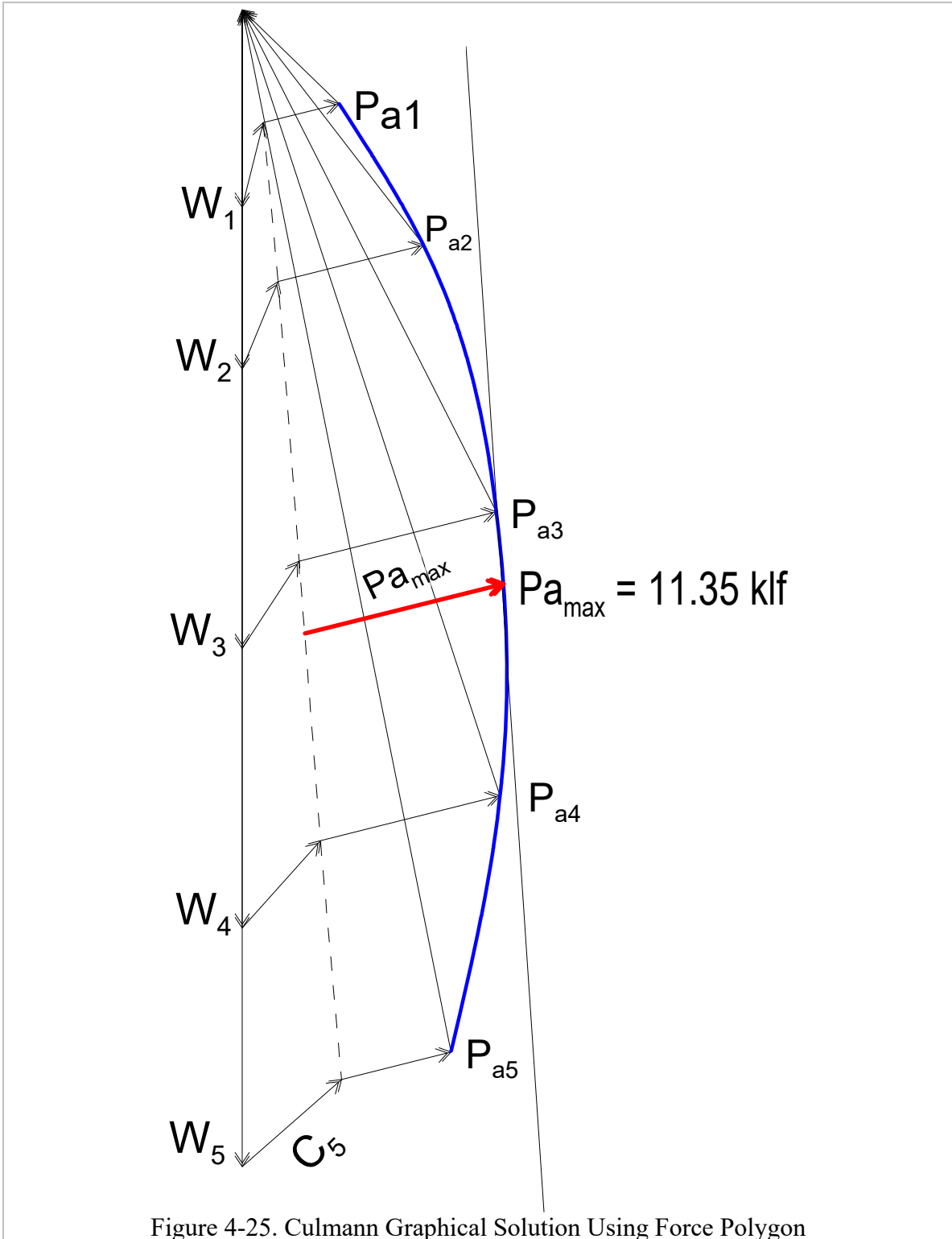

Figure 4-25. Culmann Graphical Solution Using Force Polygon

4.5.3.4 Example 4-4 (AREMA Manual page 8-5-12)

Repeat using the trial wedge method. Figure 4-26 illustrates the most critical failure surface developed using the Caltrans Trenching & Shoring Check Program.

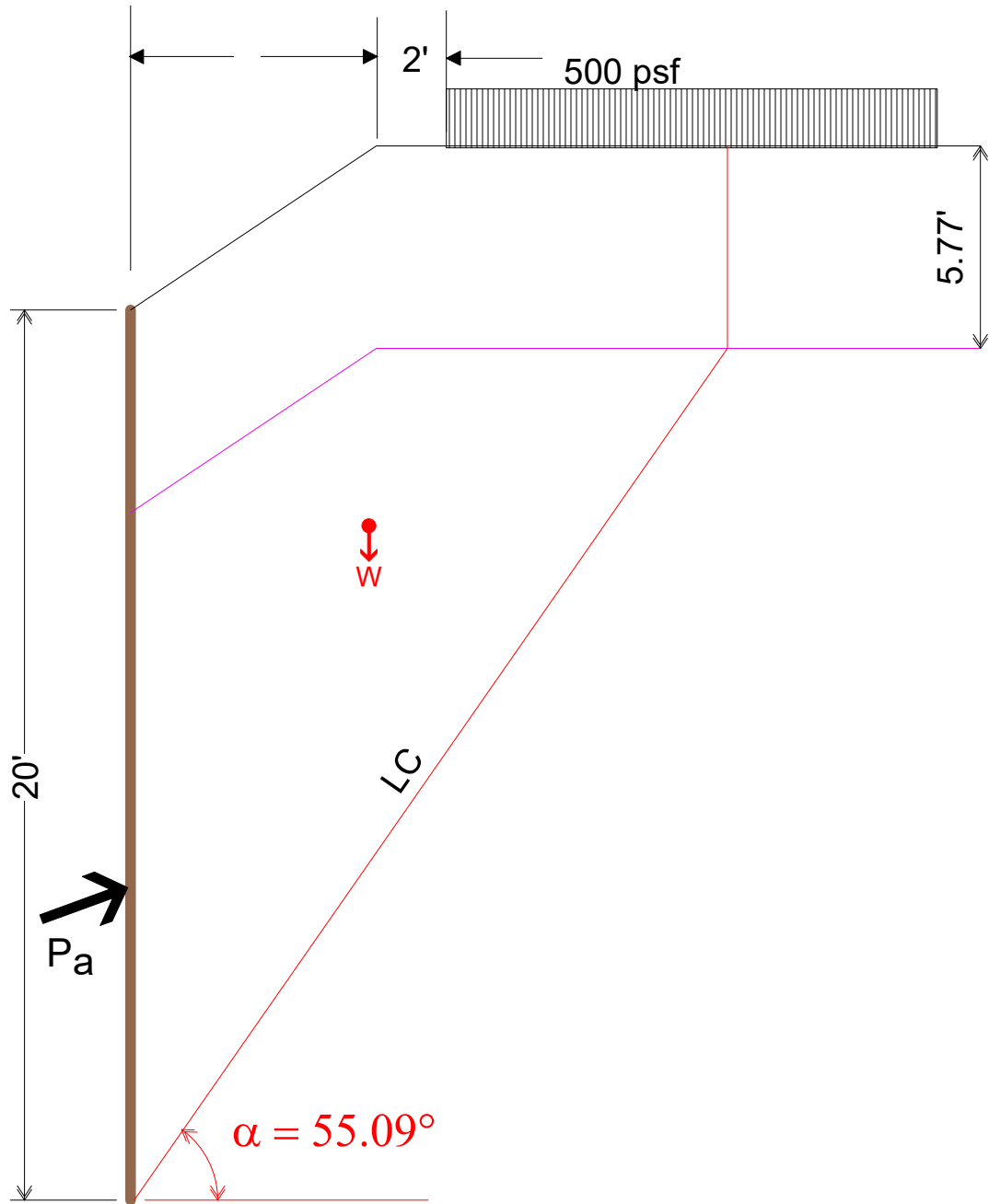

Figure 4-26. Critical Active Wedge Method

Eq. 4-42 without the adhesion component is used to calculate the active earth pressure (P_a). Caltrans Trenching & Shoring Check Program is used to calculate the failure plane angle (α) and the length of the critical failure surface (L_c).

$$P_a = \frac{W[\tan(\alpha - \phi)] - C_o L_a [\sin\alpha \tan(\alpha - \phi) + \cos\alpha]}{[1 + \tan\delta \tan(\alpha - \phi)] \cos\delta}$$

or

$$P_a = \frac{WT - COH}{[1 + \tan\delta \tan(\alpha - \phi)] \cos\delta} \quad P4.1$$

Calculate the weight contribution from weight of the wedge and weight of the surcharge (WT):

$$WT = W[\tan(\alpha - \phi)] = (38.31)[\tan(55.09 - 30)] = 17.92 \text{ k/ft}$$

Calculate cohesion (COH) component.

$$\begin{aligned} COH &= C_o L_a [\sin\alpha \tan(\alpha - \phi) + \cos\alpha] \\ &= (2)(29.55)[\tan(55.09 - 30)\sin(55.09) + \cos(55.09)] = 5.65 \text{ k/ft} \end{aligned}$$

Substitute WT and COH into equation P4.1.

$$P_a = \frac{(17.92 - 5.65)}{[1 + \tan(14)\tan(55.09 - 30)] \cos(14)} = 11.32 \text{ k/ft}$$

4.5.3.5 Example 4-5 (AREMA Manual page 8-5-13)

Calculate the maximum active earth pressure using the Culmann graphical method for a retaining wall with no heel given in Figure 4-26 using the following backfill properties.

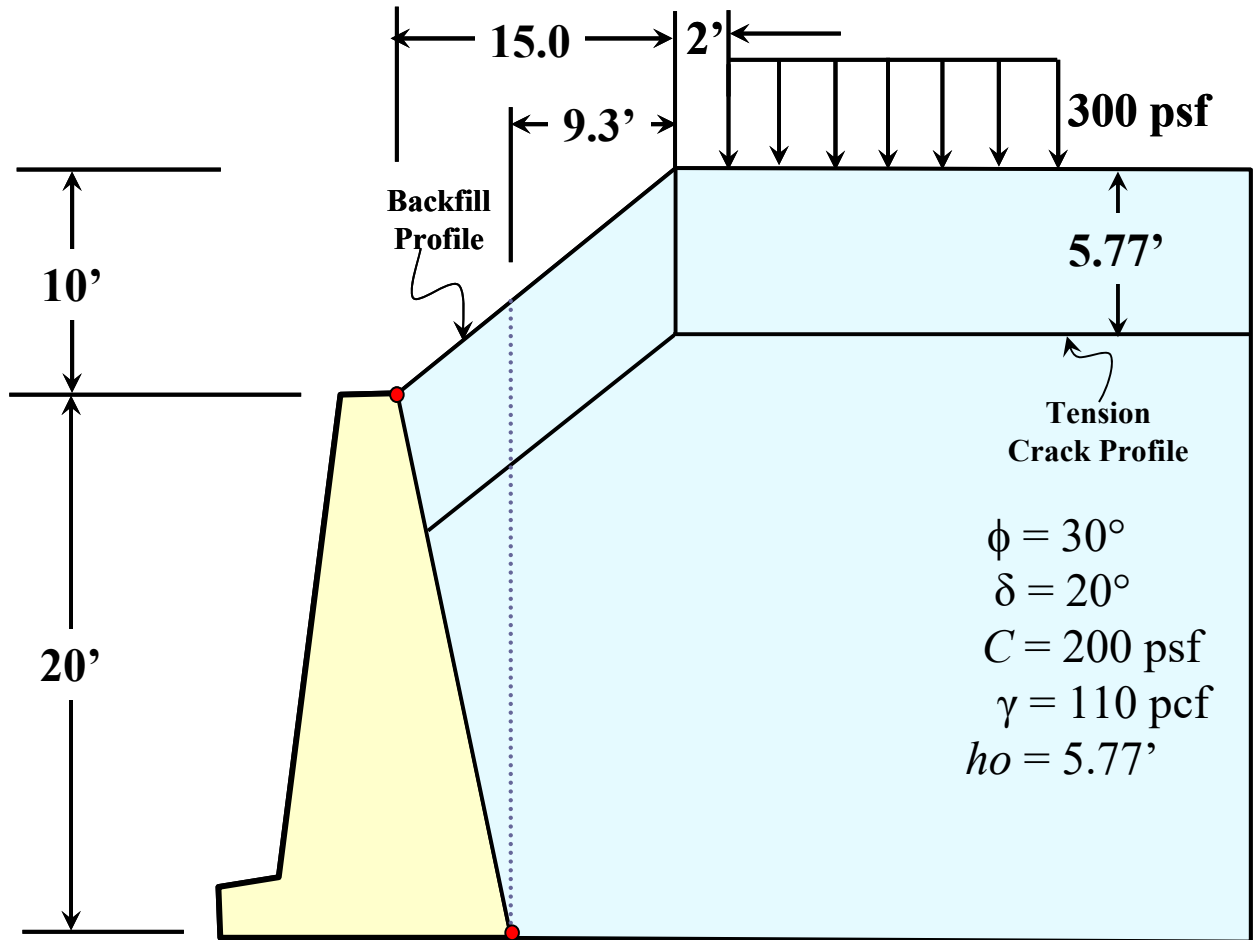

Figure 4-27. Retaining Wall with Irregular backfill

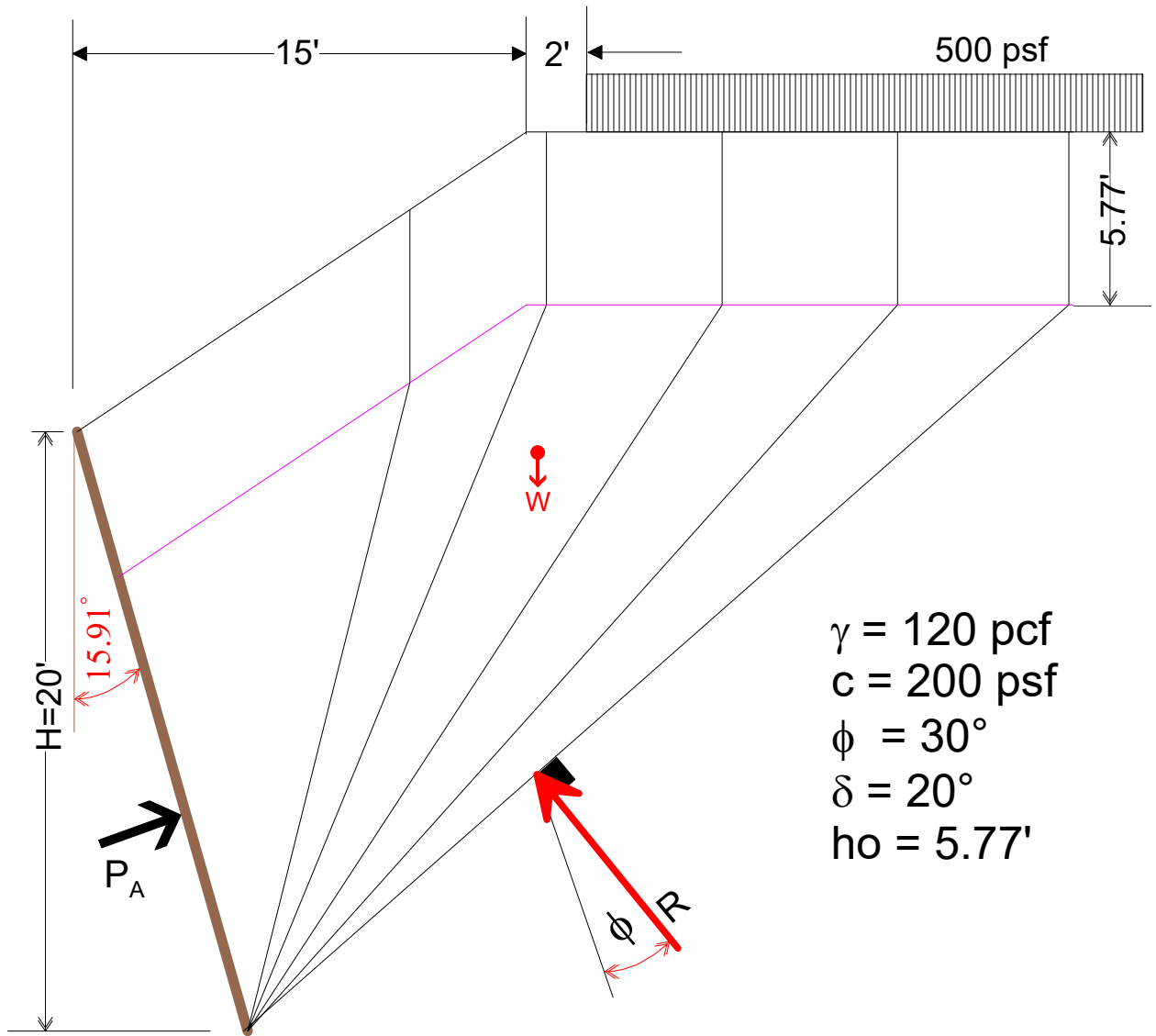
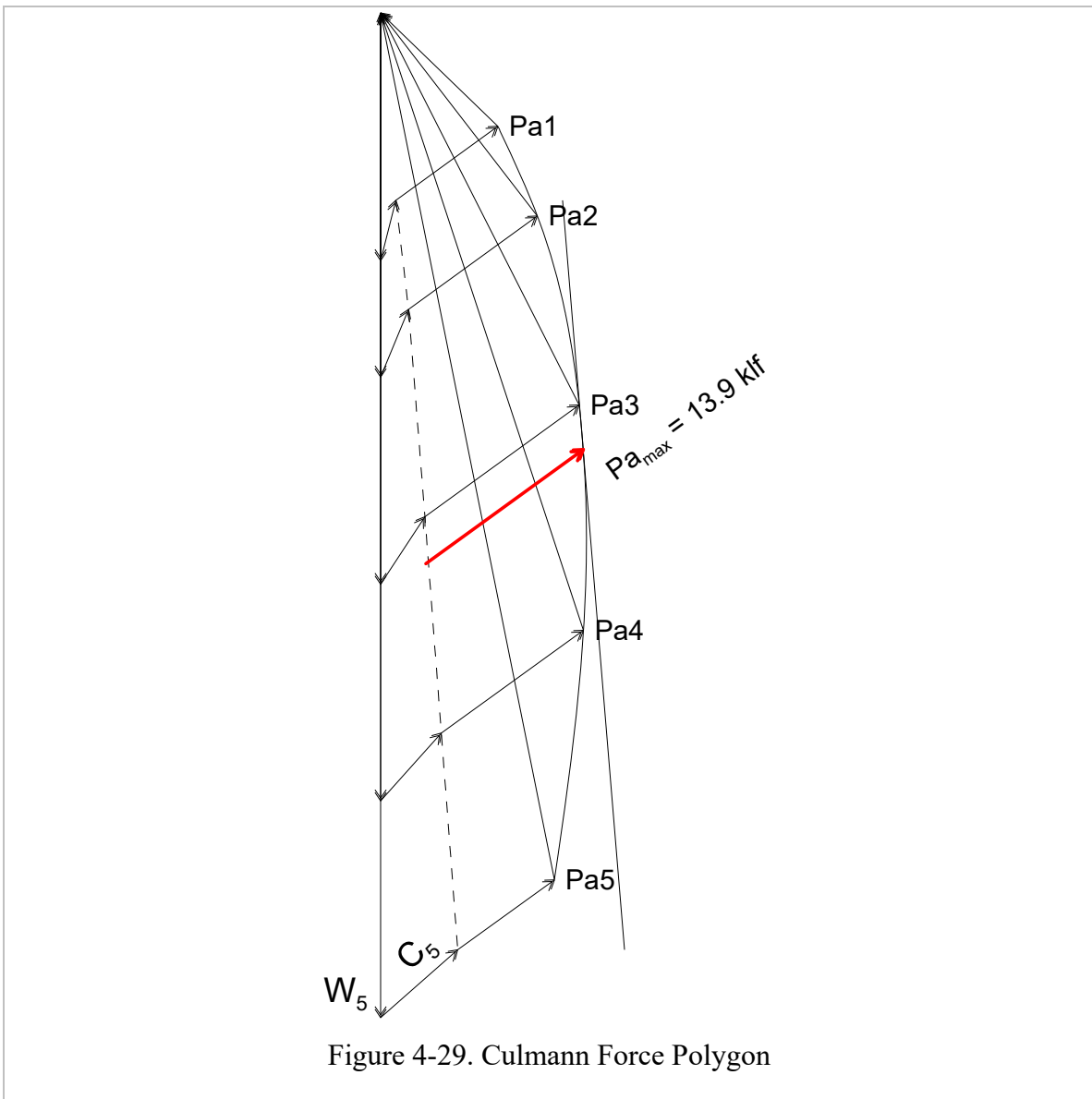

Figure 4-28. Culmann Trial Wedge

EARTH PRESSURE THEORY AND APPLICATION

Table 4-5. Culmann Graphical Method Results

Geometry			Weight Components				Cohesion Comp.		
Wedge	Backfill Profile Coordinates		Wt (k)	Σ Wt (k)	Sur. Wt (k)	Σ Sur. (k)	Total Wt (k)	Length (ft)	Coh (k)
	X	Y							
1	5.41	21.64	17.74	17.74	0	0	17.74	22.30	4.46
2	9.96	24.23	8.33	26.07	0	0	26.07	26.20	5.24
3	15.83	24.23	12.58	38.65	2.26	2.26	40.91	28.94	5.79
4	21.69	24.23	12.58	51.23	2.93	5.19	56.42	32.52	6.50
5	27.55	24.23	12.58	63.81	1.81	7.00	64.16	36.69	7.34



EARTH PRESSURE THEORY AND APPLICATION

Eq. 4-42 without the adhesion component is used to calculate the active earth pressure (P_a). Caltrans Trenching & Shoring Check Program is used to calculate the failure plane angle (α) and the length of the critical failure surface (L_c).

$$P_a = \frac{W[\tan(\alpha - \phi)] - C_o L_c [\sin\alpha \tan(\alpha - \phi) + \cos\alpha]}{[1 + \tan(\delta + \omega)\tan(\alpha - \phi)]\cos(\delta + \omega)}$$

or

$$P_a = \frac{WT - COH}{[1 + \tan(\delta + \omega)\tan(\alpha - \phi)]\cos(\delta + \omega)} \quad \text{P5-1}$$

Calculate the weight contribution from weight of the wedge and weight of the surcharge (WT):

$$WT = W[\tan(\alpha - \phi)] = (43.65)[\tan(55.18 - 30)] = 20.51 \text{ k/ft}$$

Calculate cohesion (COH) component.

$$\begin{aligned} COH &= C_o L_c [\sin\alpha \tan(\alpha - \phi) + \cos\alpha] \\ &= 0.2(29.52)[\tan(55.18 - 30)\sin(55.18) + \cos(55.18)] = 5.65 \text{ k/ft} \end{aligned}$$

Substitute WT and COH into equation P5-1.

$$P_a = \frac{(20.51 - 5.65)}{[1 + \tan(20 + 12.91)\tan(55.09 - 30)]\cos(20 + 15.91)} = 13.70 \text{ k/ft}$$

4.6 EFFECT OF WALL FRICTION

Figure 4-31 shows a shoring system with a wall-soil interface friction angle, α , that has been sufficiently extended below the dredge line. The shoring system is stable when the active earth pressure developed on the high side of the wall is opposed by much higher passive earth pressure on the low side. It can be seen that the sliding surface, Figure 4-31, for active earth pressure is practically a straight line whereas a straight line cannot approximate the sliding surface for passive earth pressure. Computation of the passive earth pressure using the log spiral failure surface is presented in the following sections.

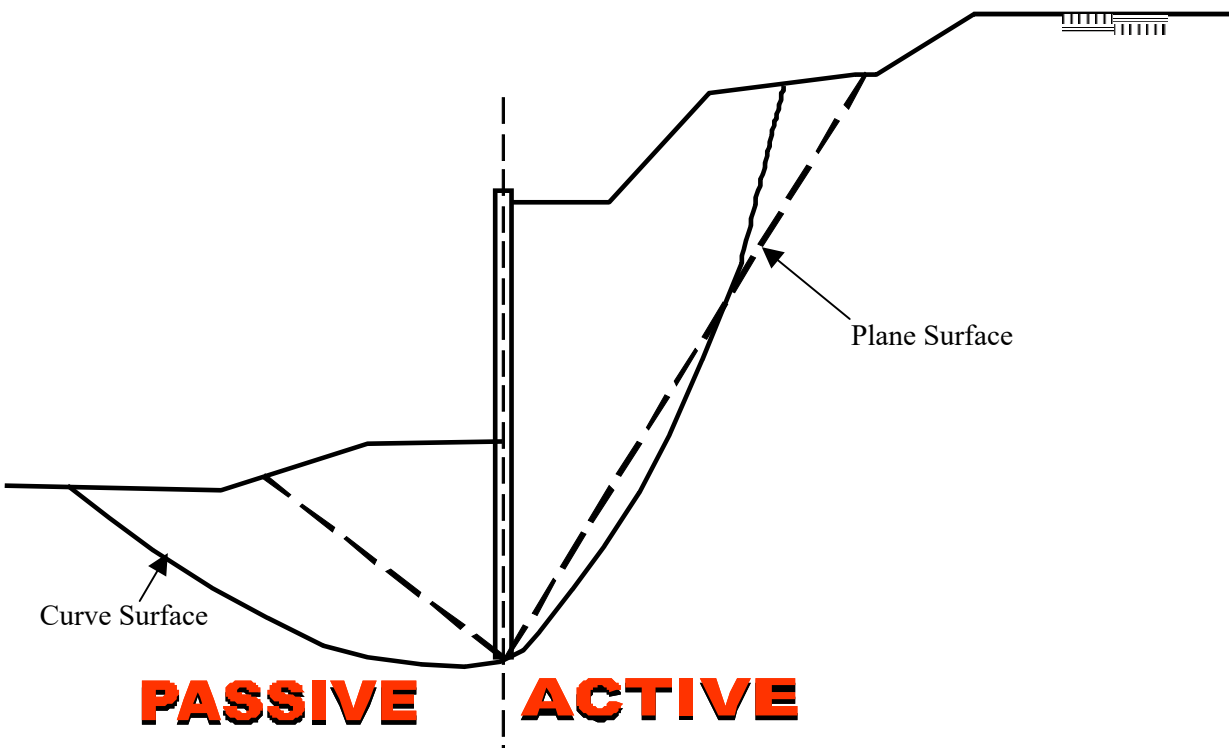

Figure 4-31. Passive Active failure surface; straight line versus spiral surface of sliding.

4.7 LOG SPIRAL PASSIVE EARTH PRESSURE

As mentioned in previous sections, Rankine's theory should not be used to calculate the passive earth pressure forces for a shoring system because it does not account for wall friction. While Coulomb's theory to determine the passive earth pressure force accounts for the angle of wall friction (δ), the theory assumes a linear failure surface. The result is an error in Coulomb's calculated force due to the fact that the actual sliding surface is curved rather than planar.

Coulomb's theory gives increasingly erroneous values of passive earth pressure as the wall friction (δ) increases. Therefore, Coulomb's theory could lead to unsafe shoring system designs because the calculated value of passive earth pressure would become higher than the soil could generate. Terzaghi (1943) suggested that combining a logarithmic spiral and a straight line could represent the failure surface. Morison and Ebeling (1995) suggested a single arc of the logarithmic spiral could realistically represent the failure surface. Both methods, (Terzaghi 1943 composite failure surface and Morison and Ebeling 1995) are implemented in this Trenching and Shoring Manual.

The composite failure surface will be examined first. As seen in Eq. 4-48 and Figure 4-32 (Shamsabadi, *et al.*, 2005), the logarithmic spiral portion of the failure surface (BD) is governed by the height of the wall (AB), the location of the center of the logarithmic spiral arc (O), and the soil's internal friction angle (ϕ) in sand and c- ϕ soil. However, the curved failure surface will be circular ($R = R_o$) in cohesive soil (for total stress analysis, $\phi = 0$). The spiral surface is given as:

$$R = R_o e^{\theta \tan \phi} \tag{Eq. 4-48}$$

R_o is obtained from triangle OAB. The upper portion of DE is a straight line, which is tangent to the curve BD at point D. DE makes an angle α_1 with the horizontal given in Eq. 4-19.

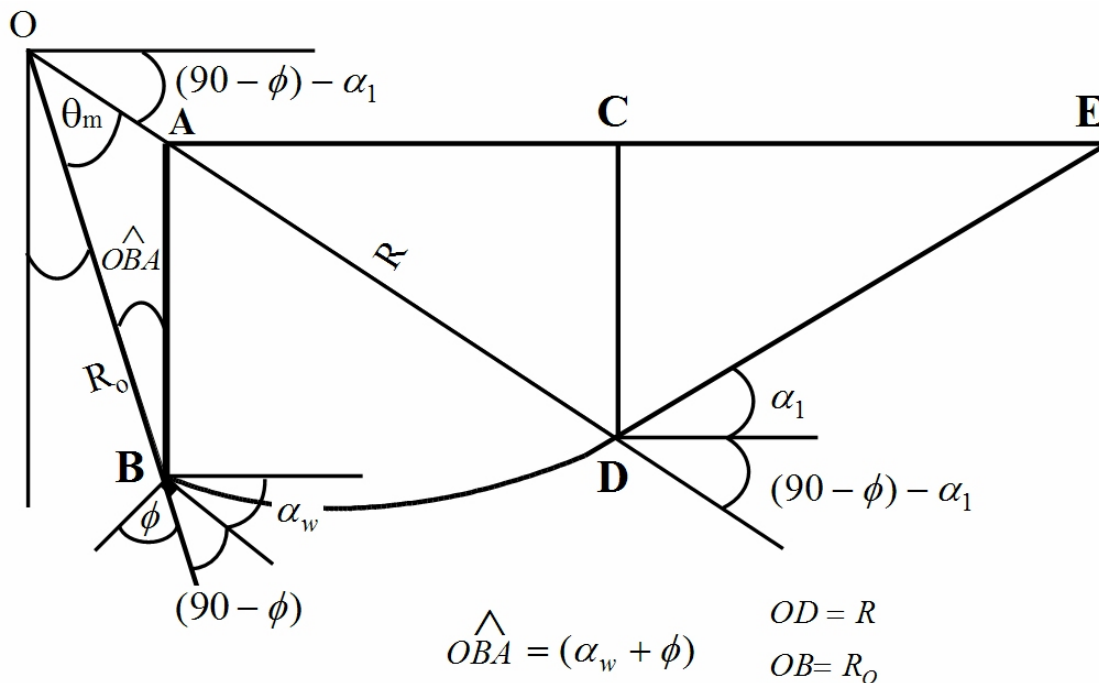

Figure 4-32. Geometry of the developing mobilized failure plane (Shamsabadi, *et al.*, 2005)

The logarithmic spiral leaves the wall at the takeoff angle (α_w) at radius OB, and intersects the conjugate failure surface wedge CDE. AD lies on a ray of the logarithmic spiral zone that must pass through the center of the logarithmic spiral arc. As a result, the location of the center of the Log-Spiral curve (O) can be accurately defined based on the subtended angle θ_m . Either moment equilibrium or force equilibrium can be used to calculate the passive earth pressure force per unit length of the wall. Several authors have calculated passive earth pressure coefficients using log spiral failure surfaces (moment method and method of slices), circular failure surfaces and elliptical failure surfaces. The shoring engineer has the option to use any of these methods.

4.7.1 Composite Failure Surface

4.7.1.1 Force Equilibrium Procedures

The log spiral surface at the bottom of the wall (Figure 4-32) starts with the takeoff angle (α_w), which is calculated as follows:

$$\alpha_w = \left(45 - \frac{\phi}{2}\right) - \alpha_p \quad \text{Eq. 4-49}$$

The angle α_w has a positive value when it is above the horizontal and a negative when it is below the horizontal.

$$\alpha_p = \frac{1}{2} \tan^{-1} \left[\frac{2K(\tan \delta)}{K-1} \right] \quad \text{Eq. 4-50}$$

Where δ is the wall interface friction angle that varies from zero to its full value δ (where $\delta = \delta_{ult}$) as a function of ϕ . The coefficient K is the horizontal to vertical stress ratio given in Eq. 4-51.

$$K = \frac{A1 + A2}{A3} \quad \text{Eq. 4-51}$$

Where:

$$A1 = 1 + \sin^2 \phi + \frac{C}{\sigma_z} \sin(2\phi) \quad \text{Eq. 4-52}$$

$$A2 = 2 \cos \phi \left(\sqrt{\left(\tan \phi + \frac{C}{\sigma_z} \right)^2 + \tan^2 \delta \left[4 \left(\frac{C}{\sigma_z} \right)^2 + \frac{C}{\sigma_z} \tan \phi \right] - 1} \right) \quad \text{Eq. 4-53}$$

$$A3 = \cos^2 \phi + 4 \tan^2 \delta \quad \text{Eq. 4-54}$$

$$\sigma_z = \gamma H$$

The value of θ_m can be obtained from the following relationships:

$$\theta_m = \alpha_1 - \alpha_w \quad \text{Eq. 4-55}$$

Where α_1 is the failure angle of slice 1 (Figure 4-33).

Therefore, the value of θ_m , can be obtained both from the geometry of the composite failure surface and/or from the state of the stresses of a soil element at the bottom of the wall. The geometry of the failure surface presented in Figure 4-32 can be established using Eq. 4-49, Eq. 4-50 and Eq. 4-55. It should be noted that the direction of the takeoff angle (α_w) is a function of the wall-soil interface friction angle (δ), the angle of internal friction (ϕ), the cohesion of the soil (C), and the wall height (H). Once the geometry of the failure plane is established then the failure mass can be divided into slices as shown in Figure 4-33. Earth pressure P_{ph} is then calculated by summation of forces in the vertical and horizontal direction for all slices using Eq. 4-56.

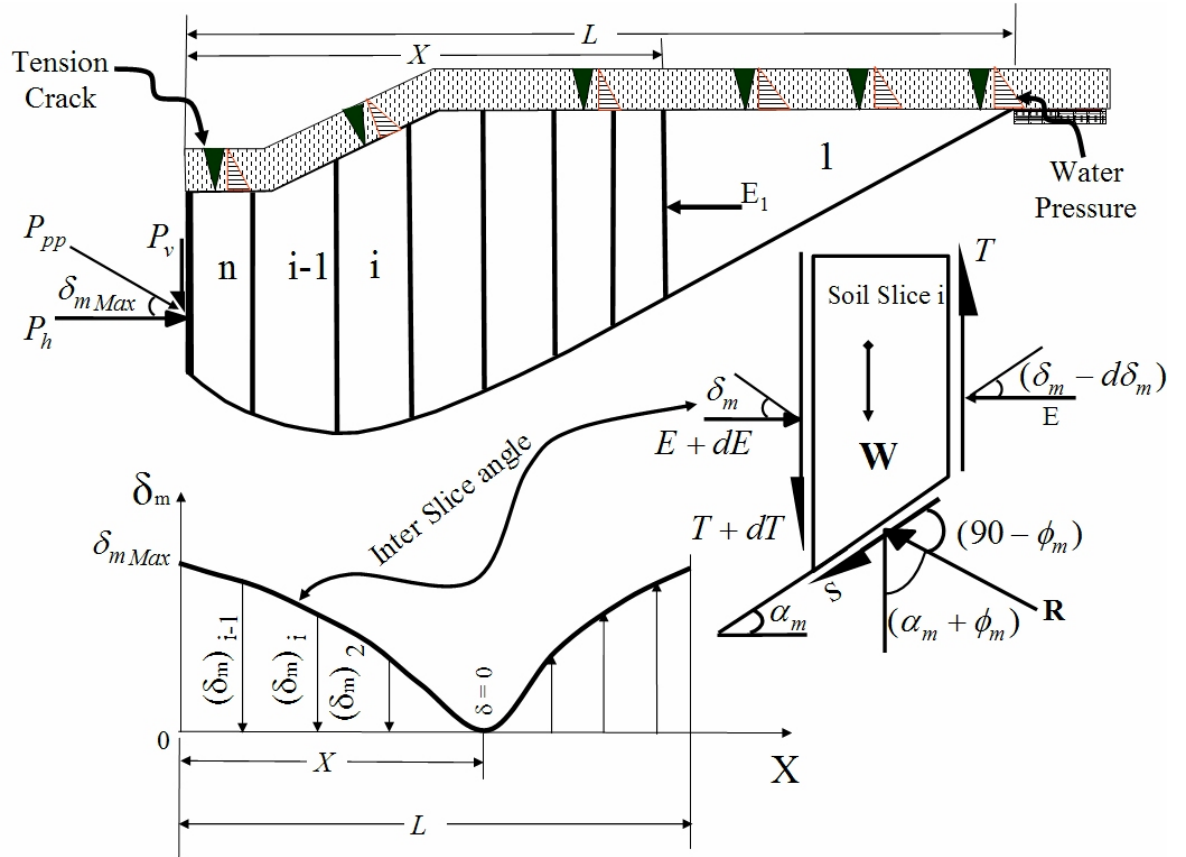

Figure 4-33. Geometry of the failure surface and associated interslice forces.

$$P_h = \frac{\sum_{i=1}^n dE}{1 - \tan \delta \tan(\alpha_w + \phi)}$$

Eq. 4-56

Where:

$$dE = \frac{W \tan(\alpha + \phi) + (C)(L) [\sin \alpha \tan(\alpha + \phi) + \cos \alpha]}{1 - \tan \delta \tan(\alpha + \phi)}$$

Eq. 4-57

By dividing the resisting wall force P_h by $0.5\gamma H^2$, one obtains the horizontal passive pressure coefficient (K_{ph}) which is expressed as:

$$K_{ph} = \frac{2 P_{ph}}{\gamma H^2}$$

Eq. 4-58

4.7.1.2 Moment Equilibrium Procedures

The passive earth pressure P_p can be determined by summing moments (rather than forces as described above) about the center of the log spiral point O considering those forces acting on the free body associated with the weight and cohesion respectively. This is a two-step process, which is solved by method of superposition. Considering the weight of the free body diagram shown in Figure 4-34, P_p can be determined as follows:

$$E_w = \frac{(W_{ABDF})(L_2) + (P_R)(L_3)}{L_1}$$

Eq. 4-59

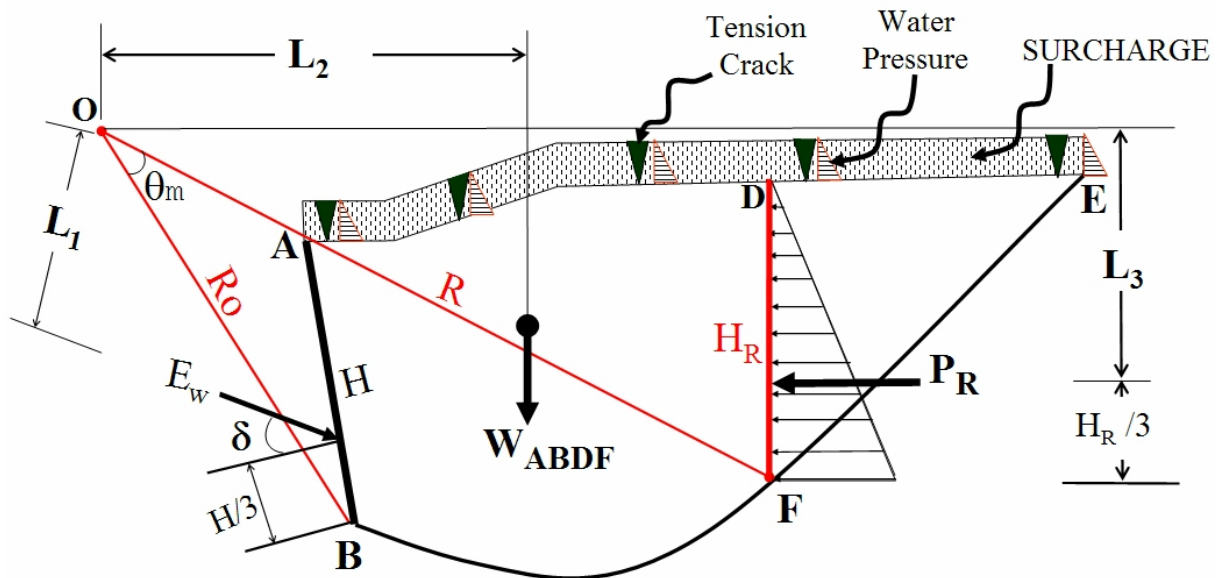

Figure 4-34. Geometry of the failure surface due to weight.

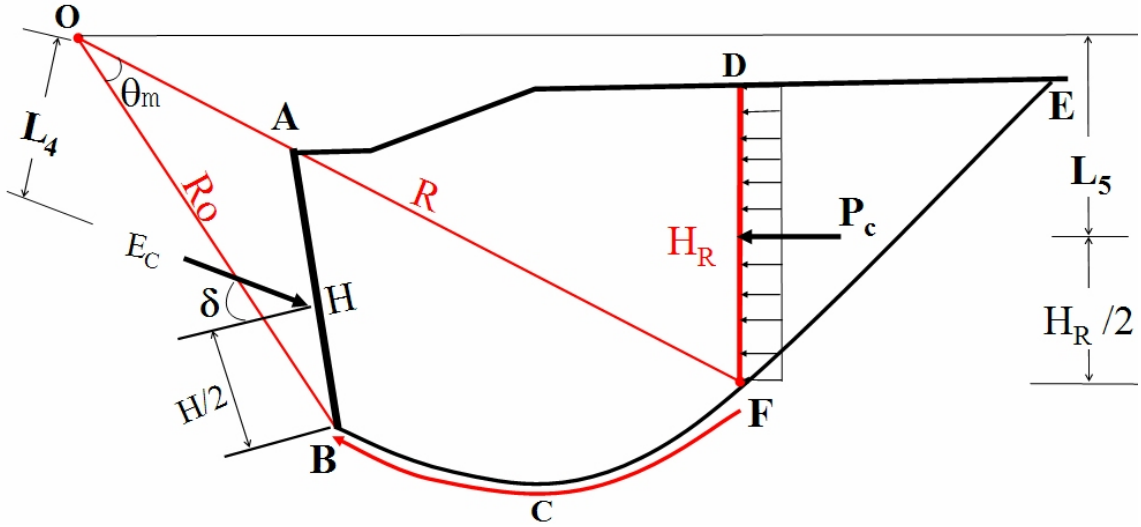

Figure 4-35. Geometry of the failure surface due to cohesion.

Considering the cohesion part of the backfill only as shown in Figure 4-34 the passive earth pressure due to cohesion (E_C) can be determined by the summation of moments about the center of log spiral point O as follows:

$$E_C = \frac{M_C + (P_C)(L_5)}{L_4} \quad \text{Eq. 4-60}$$

Where:

$$M_C = \frac{C + P_C}{\tan \phi} (R^2 - R_0^2) \quad \text{Eq. 4-61}$$

For the cohesive soil where the soil friction is equal to zero:

$$M_C = (C)(\theta)(R^2) \quad \text{Eq. 4-62}$$

W_{ABDF} = Weight of log spiral section and the surcharge weight.

H_R = Height of left side of Rankine section.

P_R = Horizontal force component of Rankine Section DFE.

P_C = Horizontal force component of Rankine Section DFE due to Cohesion.

E_w = Total lateral earth pressure due to weight.

E_C = Total lateral earth pressure due to Cohesion.

M_c = Moment due to Cohesion due to log spiral section.

Eq. 4-60 and Eq. 4-61 are obtained using the following procedures:

1. Calculate earth pressure on vertical face of DEF using Rankine's equation.

EARTH PRESSURE THEORY AND APPLICATION

2. Calculate weight of the zone ABDF including the surcharge.
3. Take the moment about point O.

The total lateral earth pressure due to weight and cohesion is the summation of Eq. 4-59 and Eq. 4-60.

$$P_p = E_w + E_c \quad \text{Eq. 4-63}$$

The passive earth pressure force P_p is obtained by summing E_w and E_c . However, this may not be the unique solution to the problem as only one trial surface is examined. The value of passive pressure P_p must be determined for several trial surfaces as shown in Figure 4-36 until the minimum value of P_p is attained. Note that failure surface 2 is the critical failure surface.

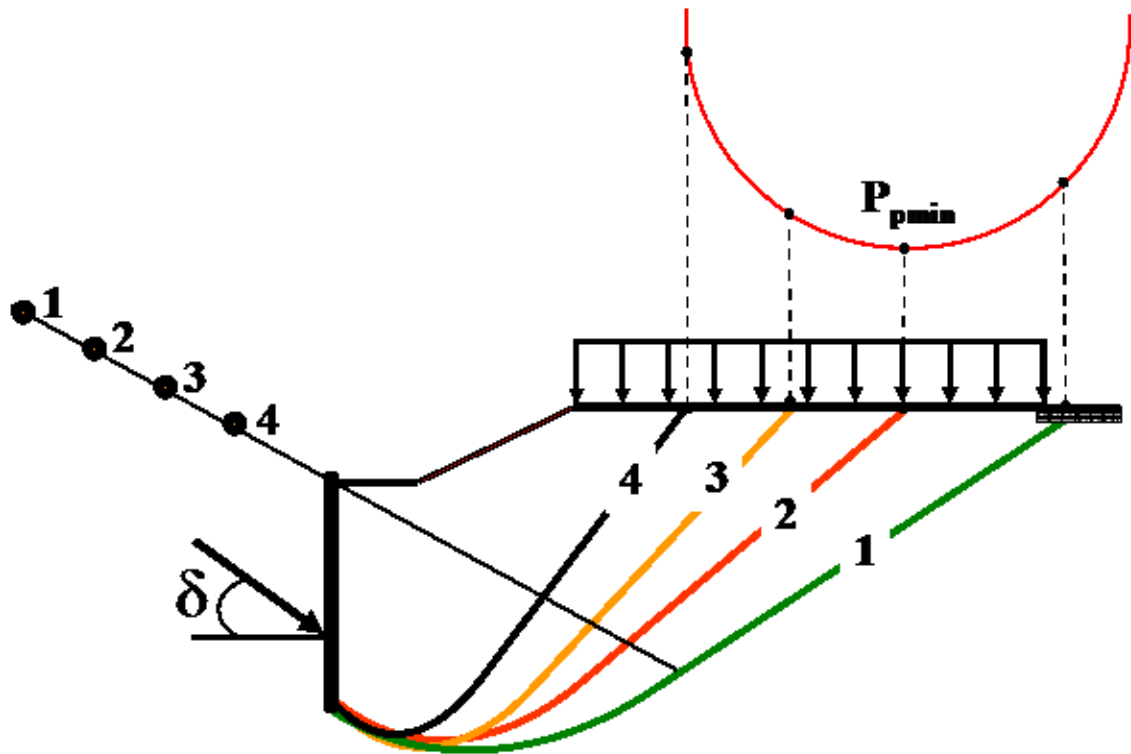

Figure 4-36. Moment Method

CT TRENCHING AND SHORING MANUAL

For non-cohesive soils, values for the passive lateral earth pressure may be taken from Figure 4-37 using the following procedure:

- Given δ , β , and ϕ .
- Calculate ratios δ/ϕ and β/ϕ .
- Determine initial K_p for β/ϕ from Figure 4-37.
- Determine reduction factor R using the ratio of δ/ϕ .
- Calculate final $K_p = R * K_p$.

EARTH PRESSURE THEORY AND APPLICATION

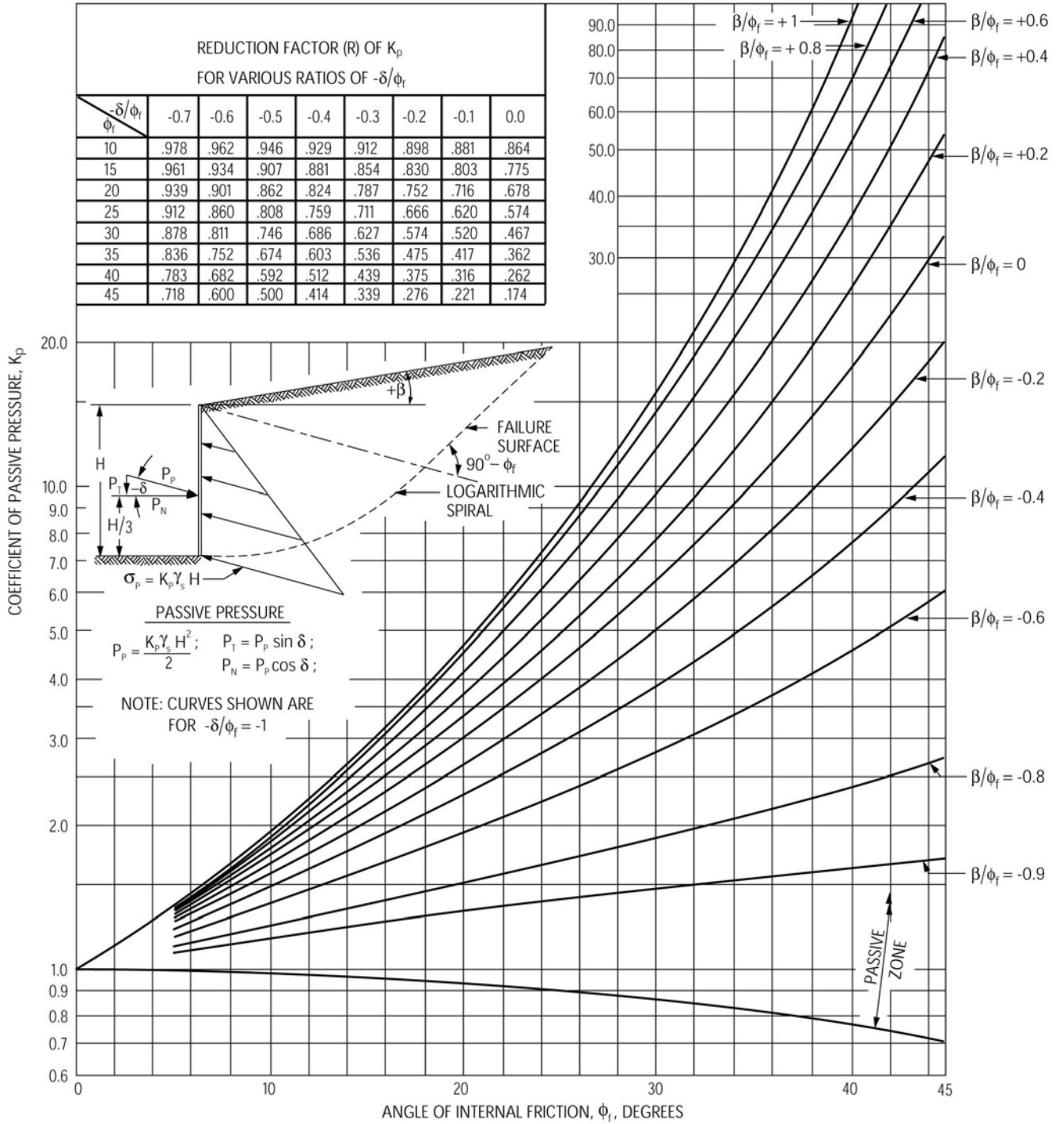

Figure 4-37. Passive earth pressure coefficient (Caquot and Kerisel, 1948)

For conditions that deviate from those described in Figure 4-37, the passive pressure may be calculated by using a trial procedure based on the trial wedge theory or a logarithmic spiral method.

4.7.2 Noncomposite Log Spiral Failure Surface

As shown in Figure 4-38, it is assumed that a single arc of the log spiral curve can represent the entire failure surface. Note, do not confuse this discussion with a "Global Stability Check" which is covered in CHAPTER 9 Section 9.4 SLOPE STABILITY. As described previously, the equations of the force equilibrium and or moment equilibrium methods are applied to calculate the passive or active force directly without breaking the failure surface into an arc of logarithmic spiral zone and a Rankine zone.

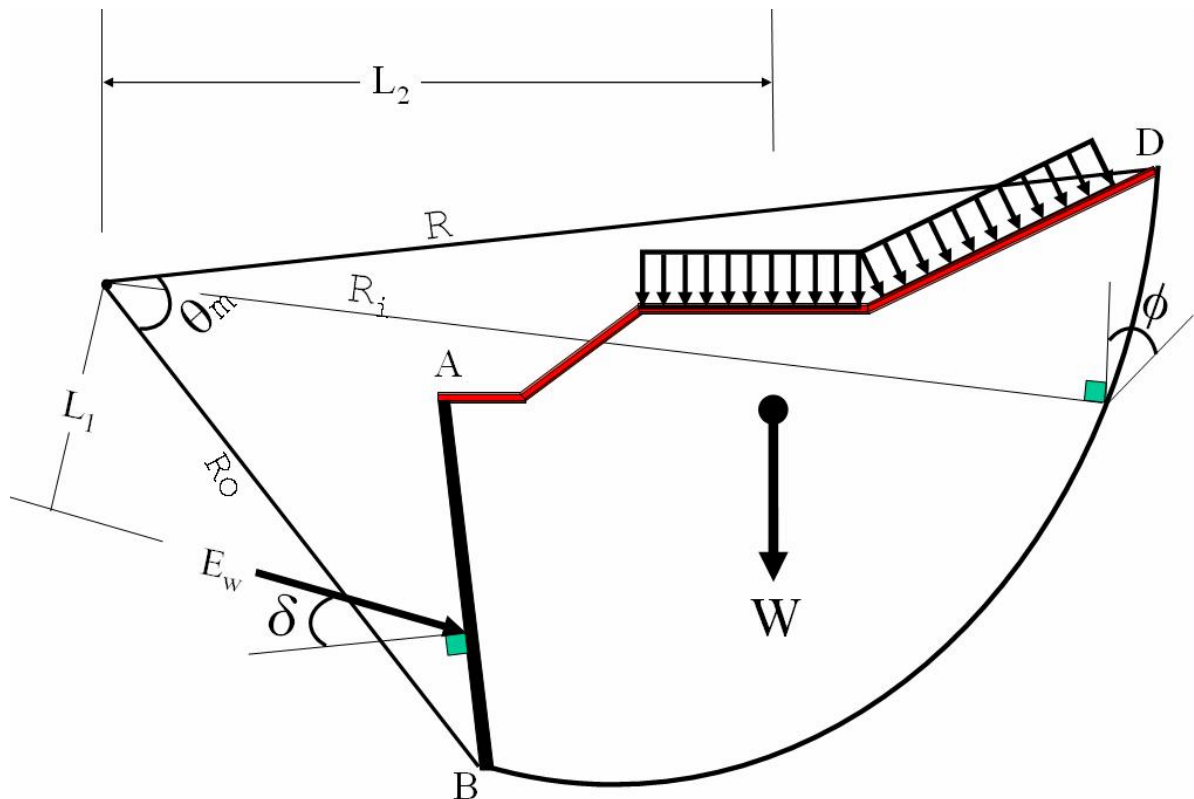

Figure 4-38. Mobilized full log spiral failure surface

4.7.2.3 Force Equilibrium Method

The formulation regarding the limit equilibrium method of slices (Shamsabadi, *et al.*, 2007, 2005) does not change since Rankine's zone was treated as a single slice. The entire mass above the failure surface BD is divided into vertical slices and Eq. 4-56 through Eq. 4-58 are used to calculate the magnitude of the earth pressure.

4.7.2.4 Moment Equilibrium Method

Only slight modifications are done to the moment limit equilibrium equations by removing the Rankine components of Eq. 4-59 and Eq. 4-60. From Figure 4-38:

$$E_w = \frac{(W_{ABD})(L_2)}{L_1} \tag{Eq. 4-64}$$

And for the cohesion component from Figure 4-38:

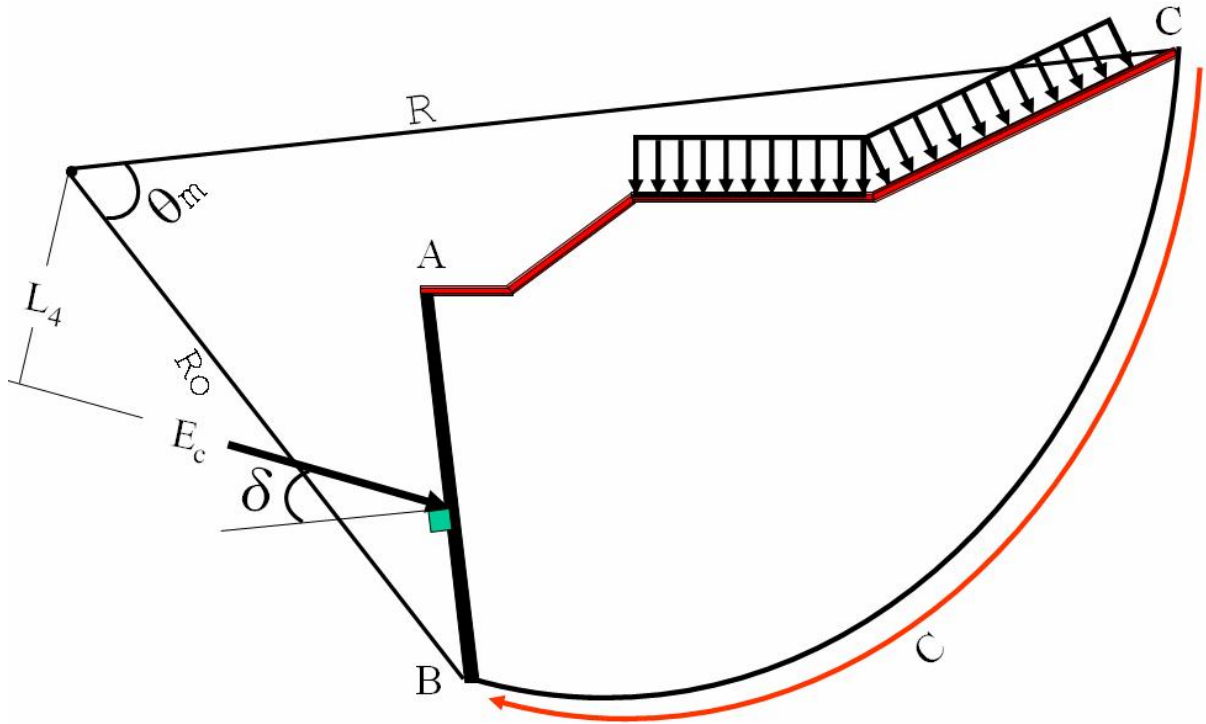

Figure 4-39. Mobilized full log spiral failure surface for cohesion component

$$E_c = \frac{M_c}{L_4} \tag{Eq. 4-65}$$

The passive earth pressure coefficients for various methods are listed in the following tables for zero slope backfill ($\beta = 0^\circ$). For sloping backfill, the value of K_{ph} should be determined by the using Figure 4-37.

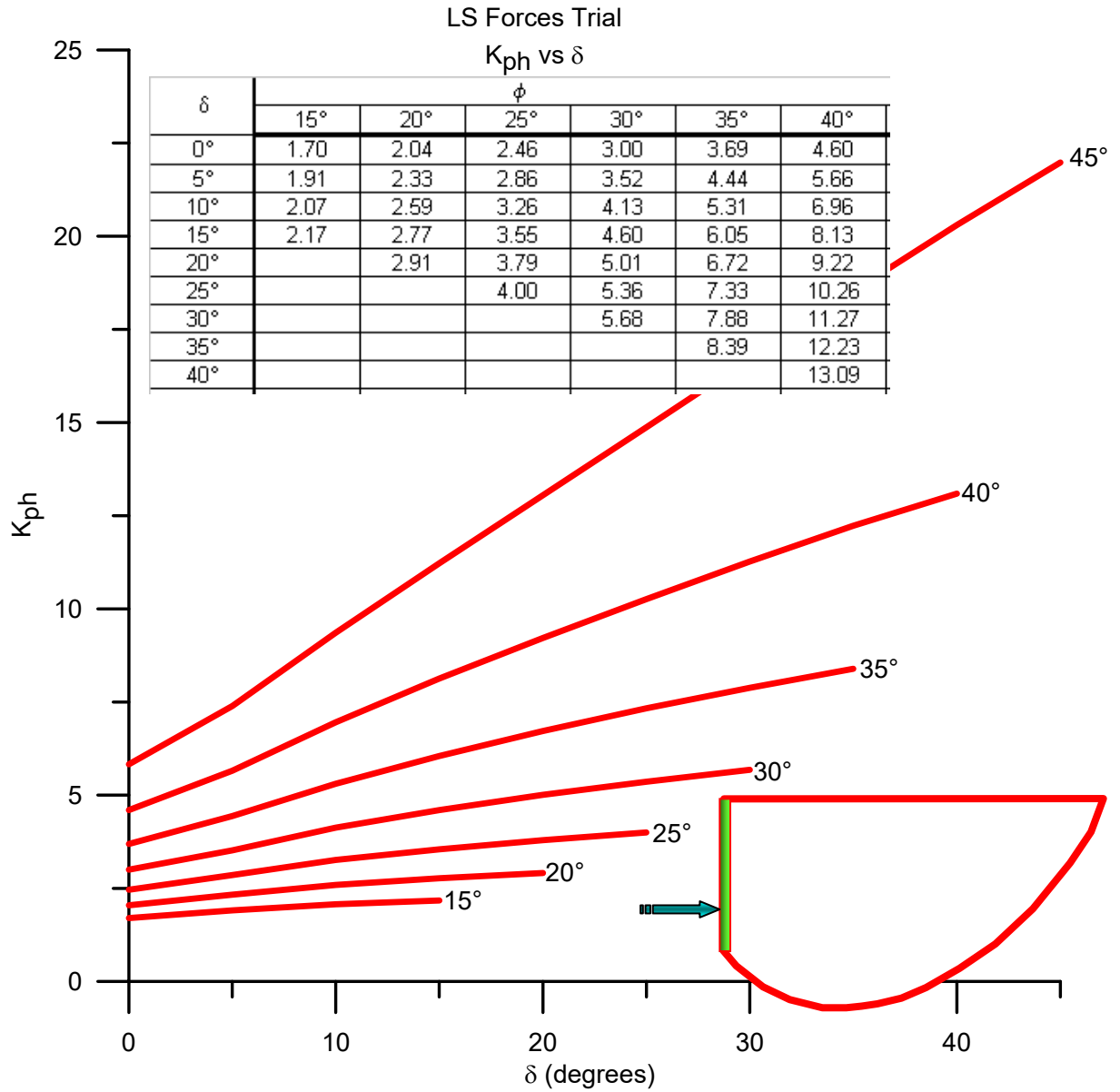

Figure 4-40. Log Spiral – Forces Method – Full Log Spiral – Trial

EARTH PRESSURE THEORY AND APPLICATION

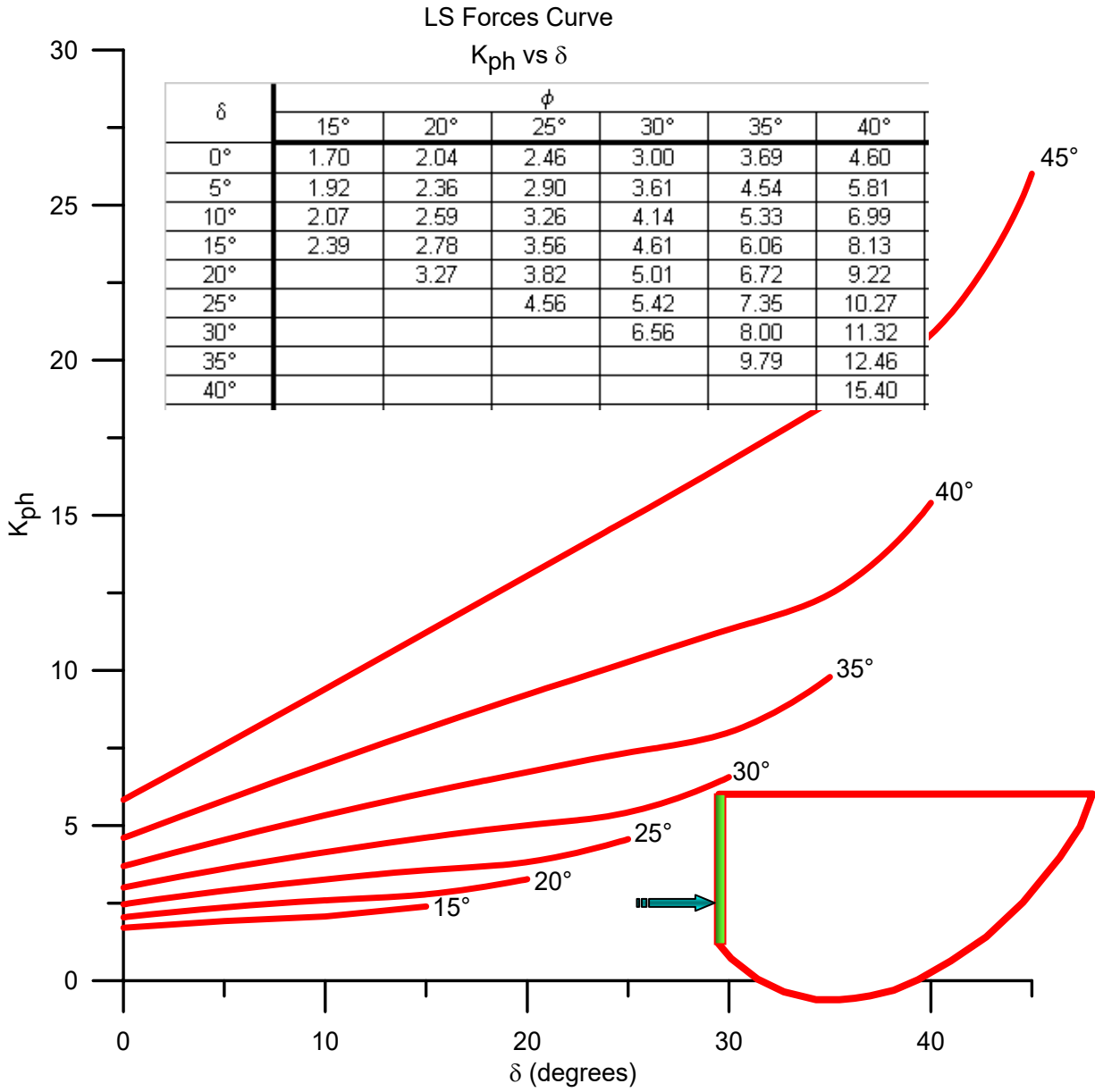

Figure 4-41. Log Spiral – Forces Method – Full Log Spiral – No Trial

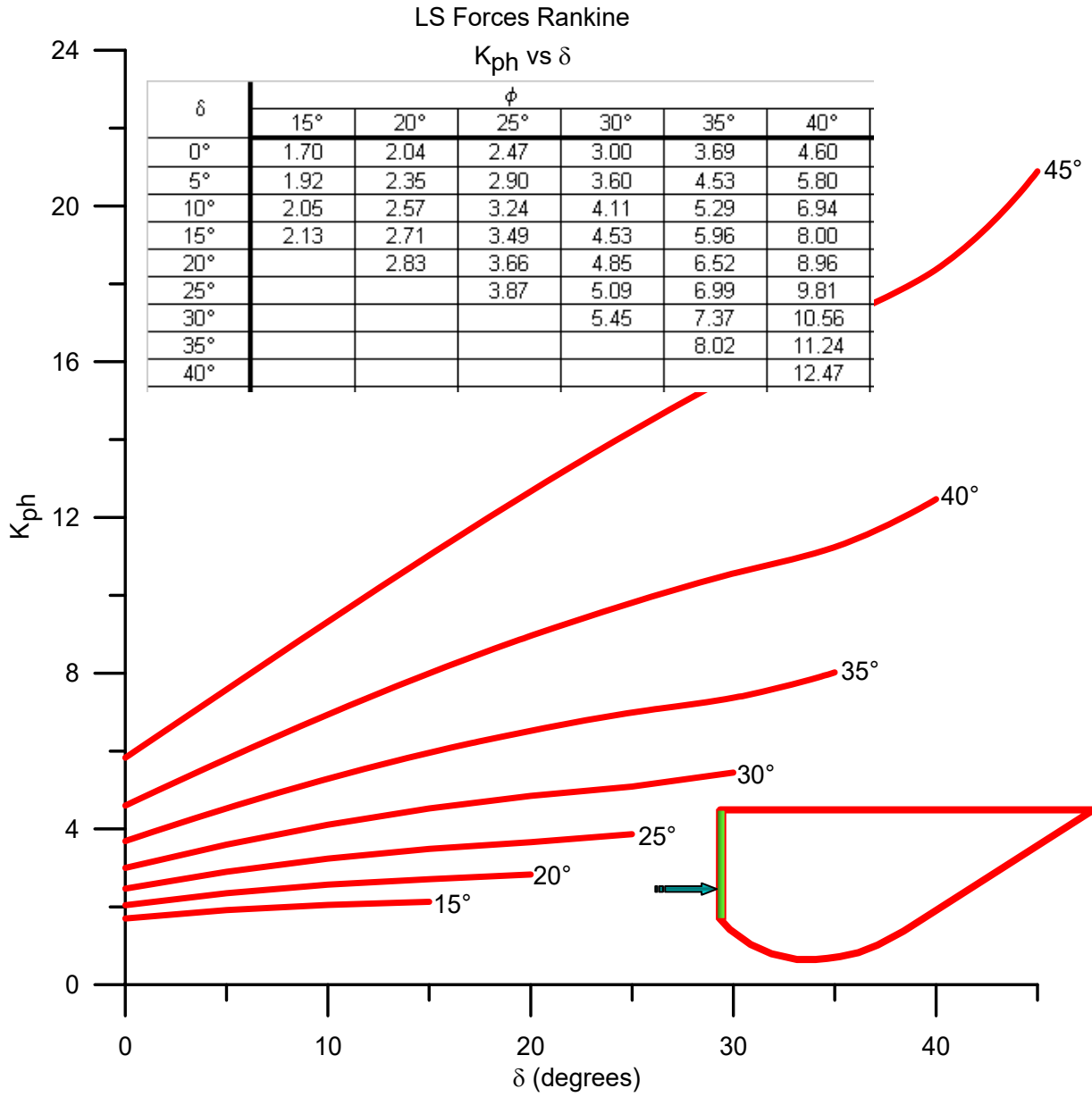

Figure 4-42. Log Spiral – Forces Method – Composite Failure Surface

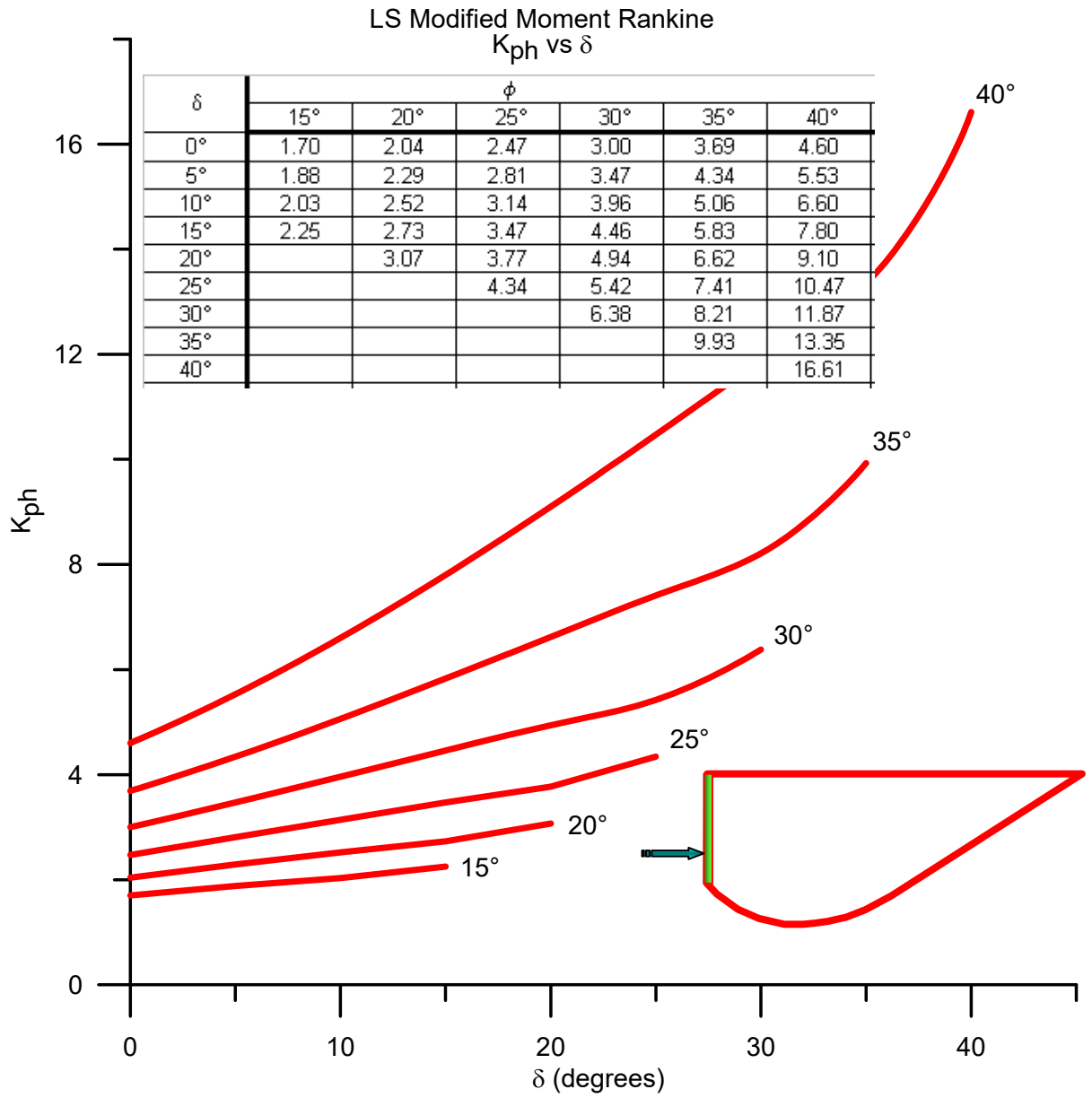

Figure 4-43. Log Spiral – Modified Moment Method – Composite Failure Surface

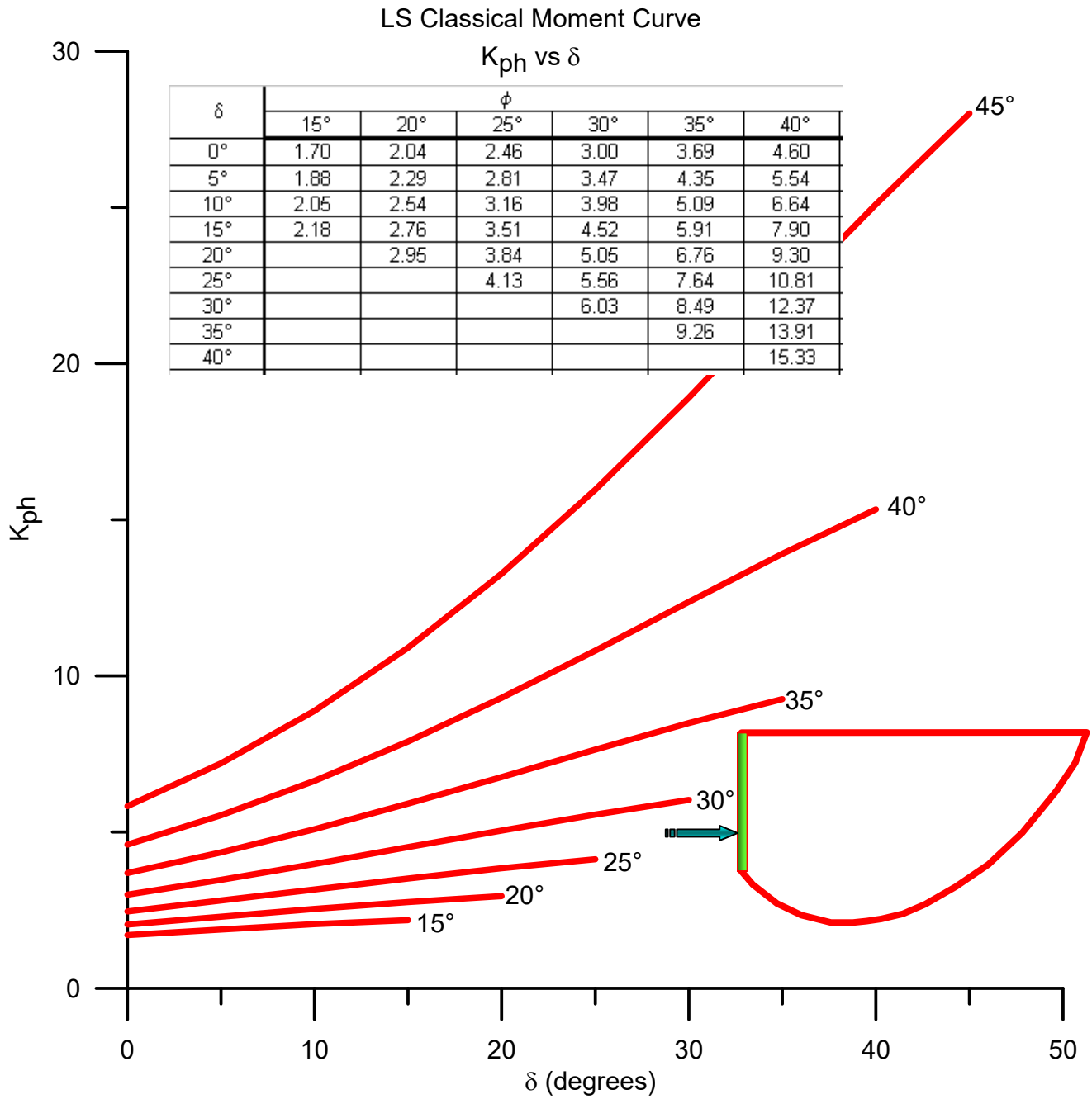

Figure 4-44. Log Spiral – Moment Method – Full Log Spiral Failure Surface

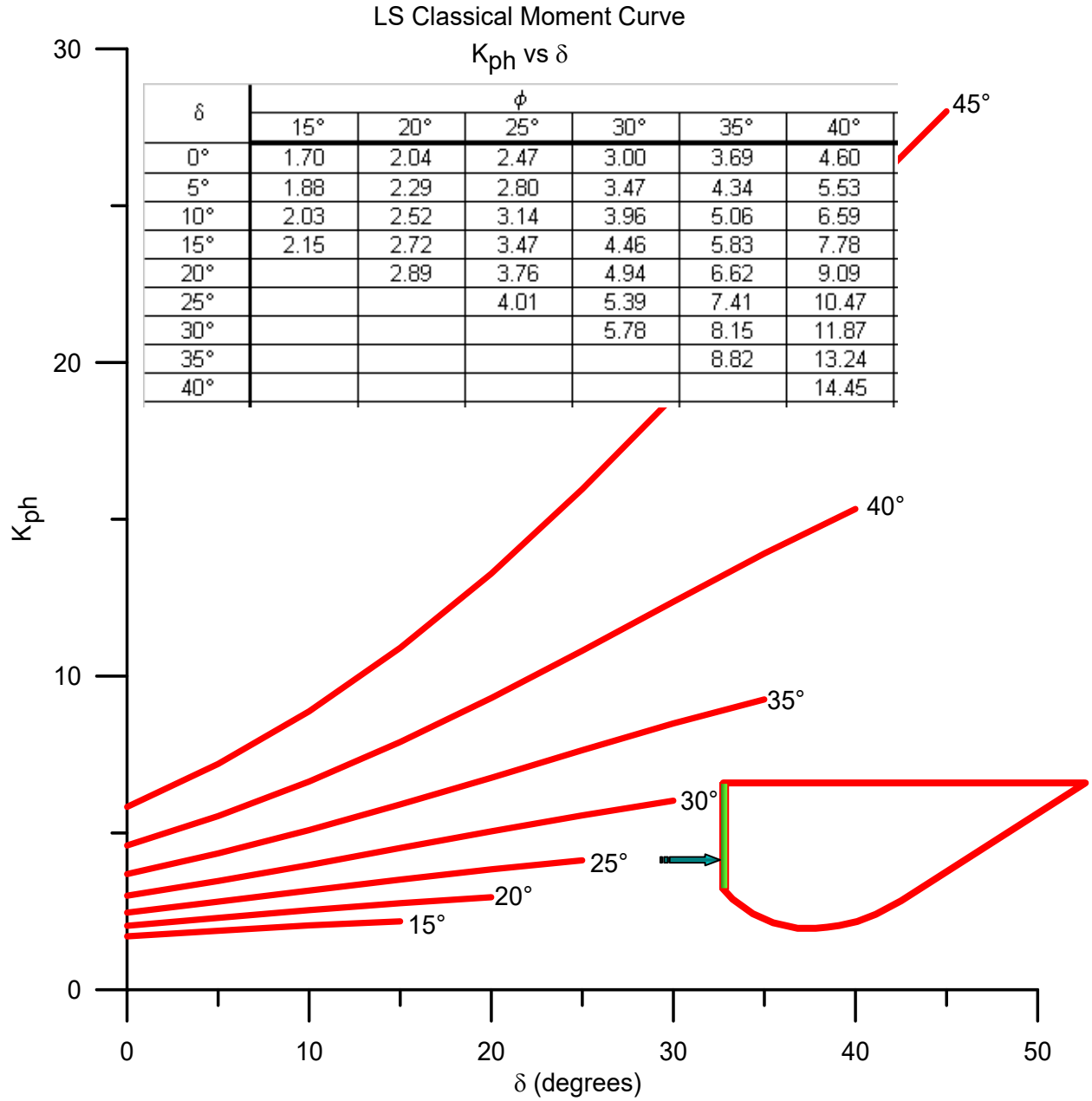

Figure 4-45. Log Spiral – Moment Method – Composite Failure Surface

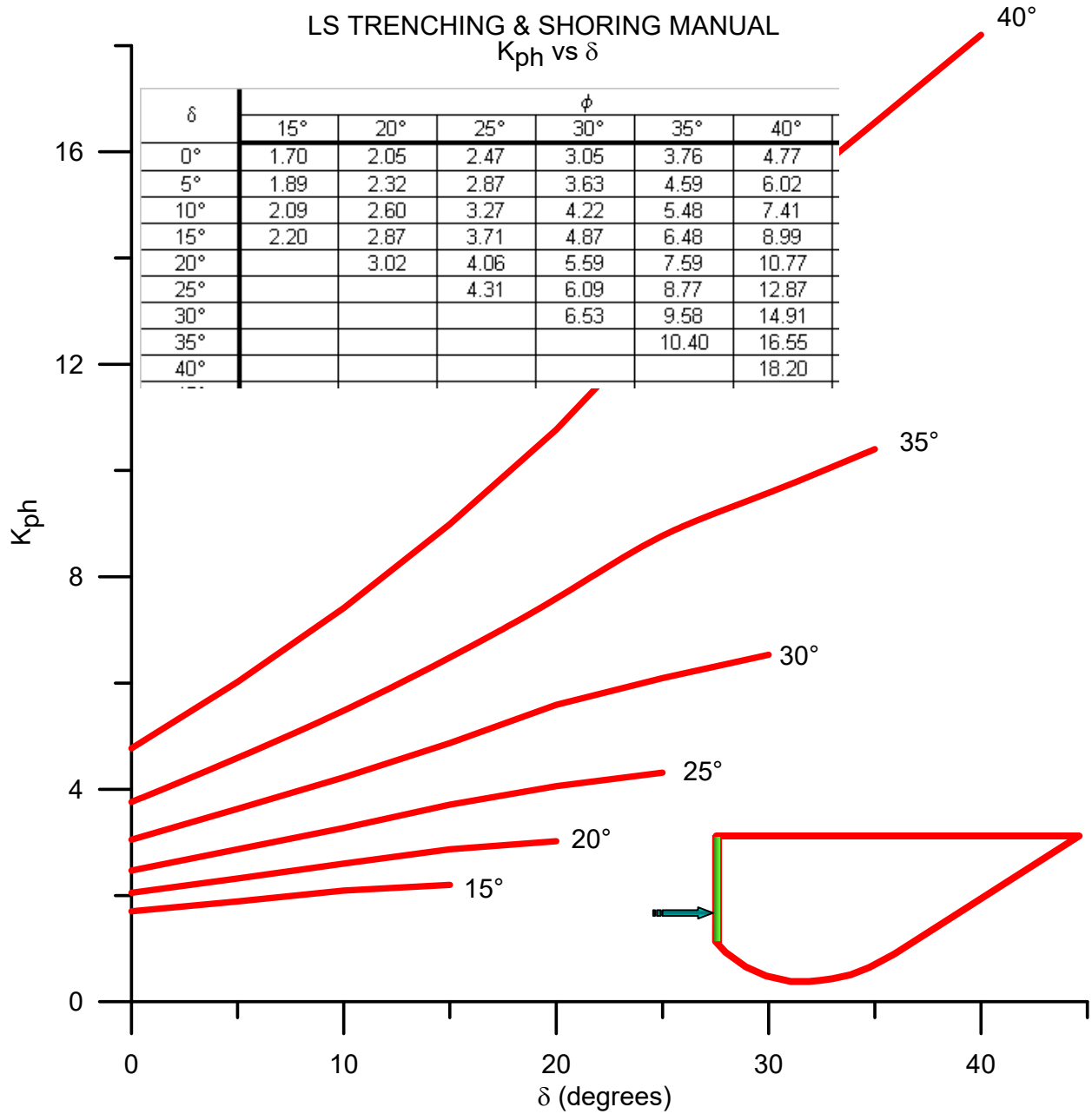

Figure 4-46. Log Spiral – see Figure 4-37

EARTH PRESSURE THEORY AND APPLICATION

Table 4-6 shows the values of K_{ph} computed by the various log spiral and straight line methods described above and shown in Figure 4-31 on page 4-50. When the wall interface friction (δ) less than about 1/3 of the backfill soil friction angle (ϕ) the value of K_{ph} does not differ significantly. However, for large values of wall interface friction angle (δ), the values of K_{ph} should be determined by the using the log spiral methods. Note that the values listed in the following table are for the purposes of comparison of the various methods with zero slope backfill ($\beta = 0^\circ$).

Table 4-6. K_{ph} based on straight or curved rupture lines with zero slope backfill ($\beta = 0^\circ$)

ϕ	δ/ϕ	K_{ph}						
		Straight Line		Log Spiral				
		Rankine	Coulomb/ Trial Wedge	Forces			Moment	
				Trial	Curve	Composite	Curve	Composite
30°	0	3.00	3.00	3.00	3.00	3.00	3.00	3.00
	1/3	3.00	4.14	4.13	4.14	4.11	3.98	3.96
	2/3	3.00	6.11	5.01	5.01	4.85	5.05	4.94
	1	3.00	10.10	5.68	6.56	5.45	6.03	5.78
35°	0	3.69	3.69	3.69	3.69	3.69	3.69	3.69
	1/3	3.69	5.68	5.57	5.58	5.53	5.36	5.31
	2/3	3.69	9.96	7.13	7.14	6.84	7.35	7.15
	1	3.69	22.97	8.39	9.79	8.02	9.26	8.82
40°	0	4.60	4.60	4.60	4.60	4.60	4.60	4.60
	1/3	4.60	8.15	7.75	7.76	7.66	7.46	7.37
	2/3	4.60	18.72	10.60	10.62	10.07	11.33	10.94
	1	4.60	92.59	13.09	15.40	12.47	15.33	14.45

4.8 SURCHARGE LOADS

A surcharge load is any load which is imposed upon the surface of the soil close enough to the excavation to cause a lateral pressure to act on the system in addition to the basic earth pressure. Groundwater will also cause an additional pressure, but it is not a surcharge load.

Examples of surcharge loads are spoil embankments adjacent to the trench, streets or highways, construction machinery or material stockpiles, adjacent buildings or structures, and railroads.

4.8.1 Minimum Construction Surcharge Load

The minimum lateral construction surcharge of 72 psf (σ_h) shall be applied to the shoring system to a depth of 10 feet (H_s) below the shoring system or to the excavation line whichever is less. See Figure 4-47. This is the minimum surcharge loading that shall be applied to any shoring system regardless of whether or not the system is actually subjected to a surcharge loading. Surcharge loads which produce lateral pressures greater than 72 psf would be used in lieu of this prescribed minimum.

This surcharge is intended to provide for the normal construction loads imposed by small vehicles, equipment, or materials, and workmen on the area adjacent to the trench or excavation. It should be added to all basic earth pressure diagrams. This minimum surcharge can be compared to a soil having parameters of $\gamma = 109$ pcf and $K_a = 0.33$ for a depth of 2 feet [$(0.33)(109)(2) = 72$ psf]

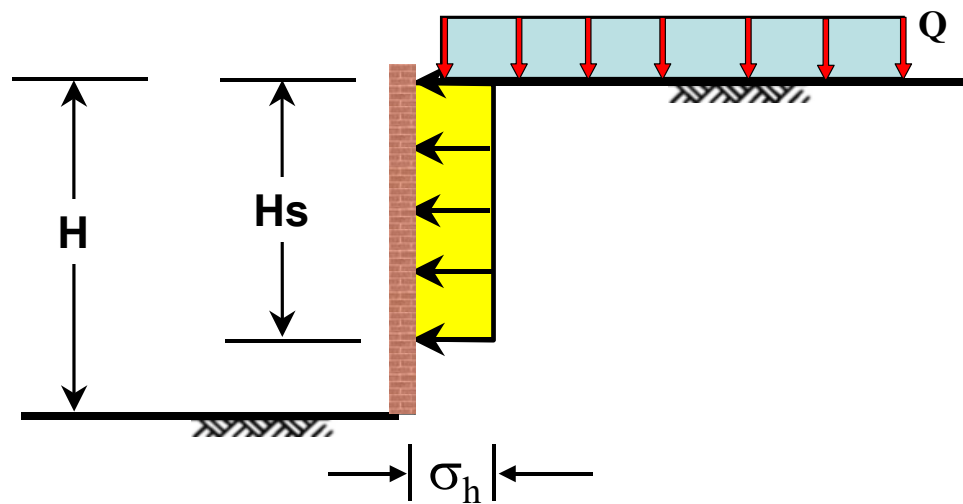

Figure 4-47. Minimum Lateral Surcharge Load

4.8.2 Uniform Surcharge Loads

Where a uniform surcharge is present, a constant horizontal earth pressure must be added to the basic lateral earth pressure. This constant earth pressure may be taken as:

$$\sigma_h = (K)(Q) \quad \text{Eq. 4-66}$$

Where:

σ_h = constant horizontal earth pressure due to uniform surcharge

K = coefficient of lateral earth pressure due to surcharge for the following conditions:

- Use K_a for active earth pressure.
- Use K_o for at-rest earth pressure.

Q = uniform surcharge applied to the wall backfill surface within the limits of the active failure wedge.

4.8.3 Boussinesq Loads

Typically, there are three (3) types of Boussinesq Loads. They are as follows:

4.8.3.1 Strip Load

Strip loads are loads such as highways and railroads that are generally parallel to the wall.

The general equation for determining the pressure at distance h below the ground line is (See Figure 4-48):

$$\sigma_h = \frac{2Q}{\pi} [\beta_R - \sin \beta \cos(2\alpha)] \quad \text{Eq. 4-67}$$

Where β_R is in radians.

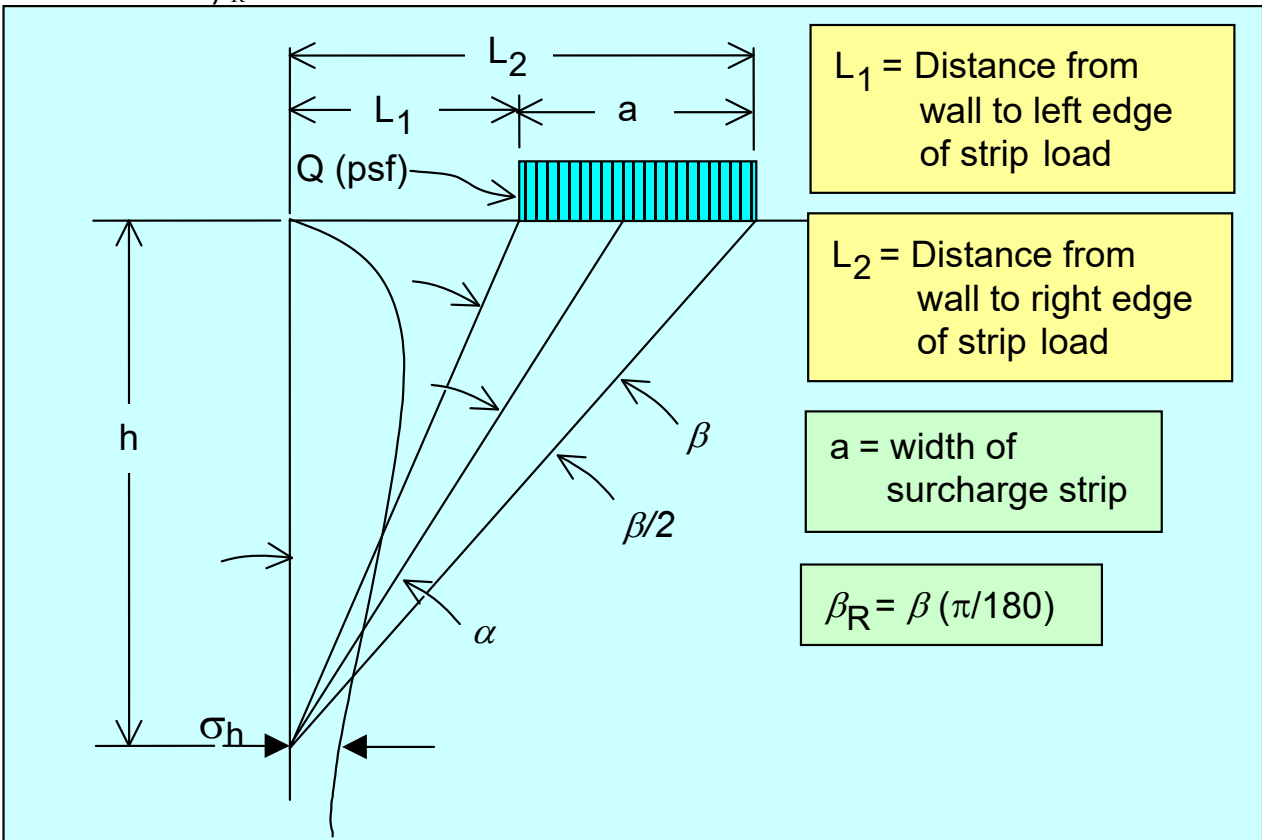

Figure 4-48. Boussinesq Type Strip Load

4.8.3.2 Line Load

A line load is a load such as a continuous wall footing of narrow width or similar load generally parallel to the wall. K-Railing could be considered to be a line load.

The general equation for determining the pressure at distance h below the ground line is:
(See Figure 4-49)

For $m \leq 0.4$:

$$\sigma_h = \frac{Q_l}{H} \frac{0.2n}{(0.16 + n^2)^2} \quad \text{Eq. 4-68}$$

For $m > 0.4$

$$\sigma_h = 1.28 \frac{Q_l}{H} \frac{m^2 n}{(m^2 + n^2)^2} \quad \text{Eq. 4-69}$$

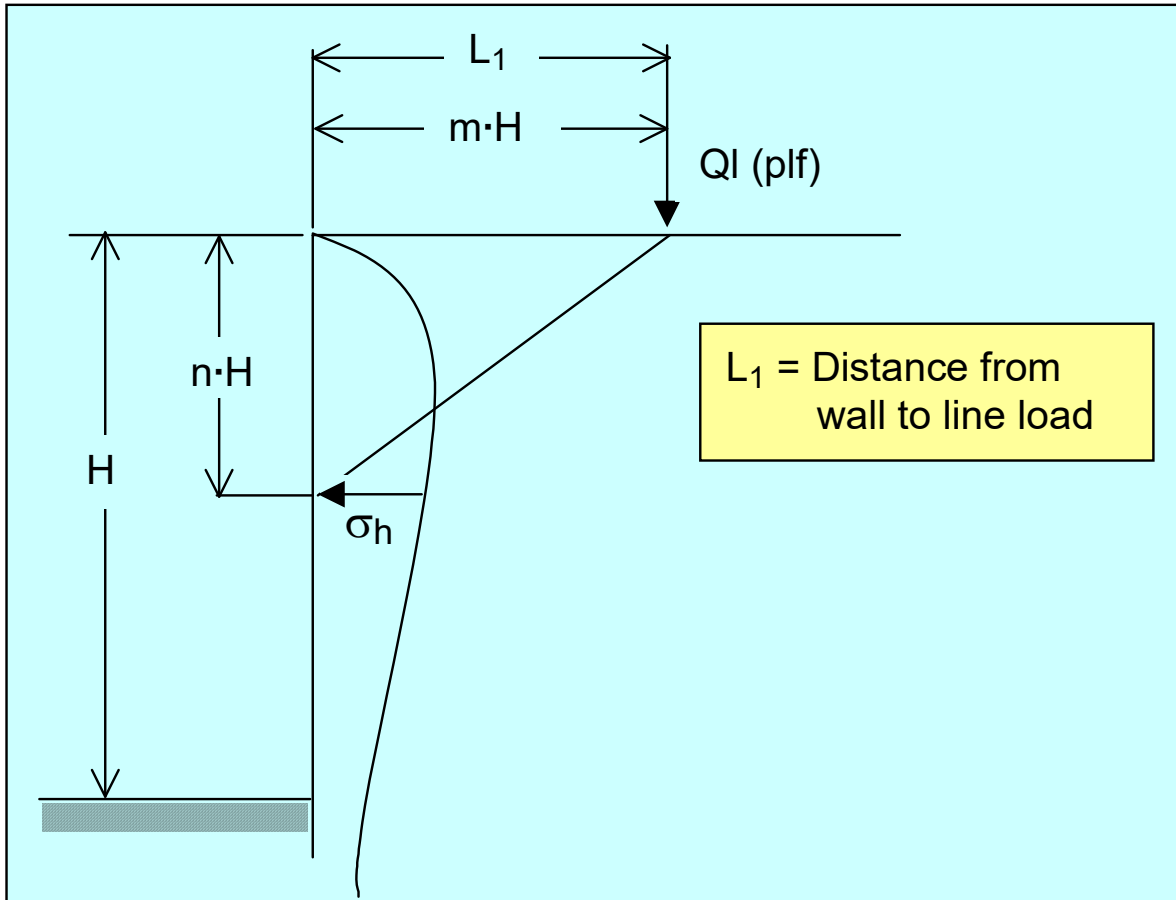

Figure 4-49. Boussinesq Type Line Load

4.8.3.3 Point Load

Point loads are loads such as outrigger loads from a concrete pump or crane. A wheel load from a concrete truck may also be considered a point load when the concrete truck is adjacent an excavation and in the process of the unloading. The truck could be positioned either parallel or perpendicular to the excavation.

The general equation for determining the pressure at distance h below the ground line is:
(See Figure 4-50)

For $m \leq 0.4$:

$$\sigma_h = 0.28 \frac{Q_p}{H^2} \frac{n^2}{(0.16 + n^2)^3} \quad \text{Eq. 4-70}$$

For $m > 0.4$

$$\sigma_h = 1.77 \frac{Q_p}{H^2} \frac{m^2 n^2}{(m^2 + n^2)^3} \quad \text{Eq. 4-71}$$

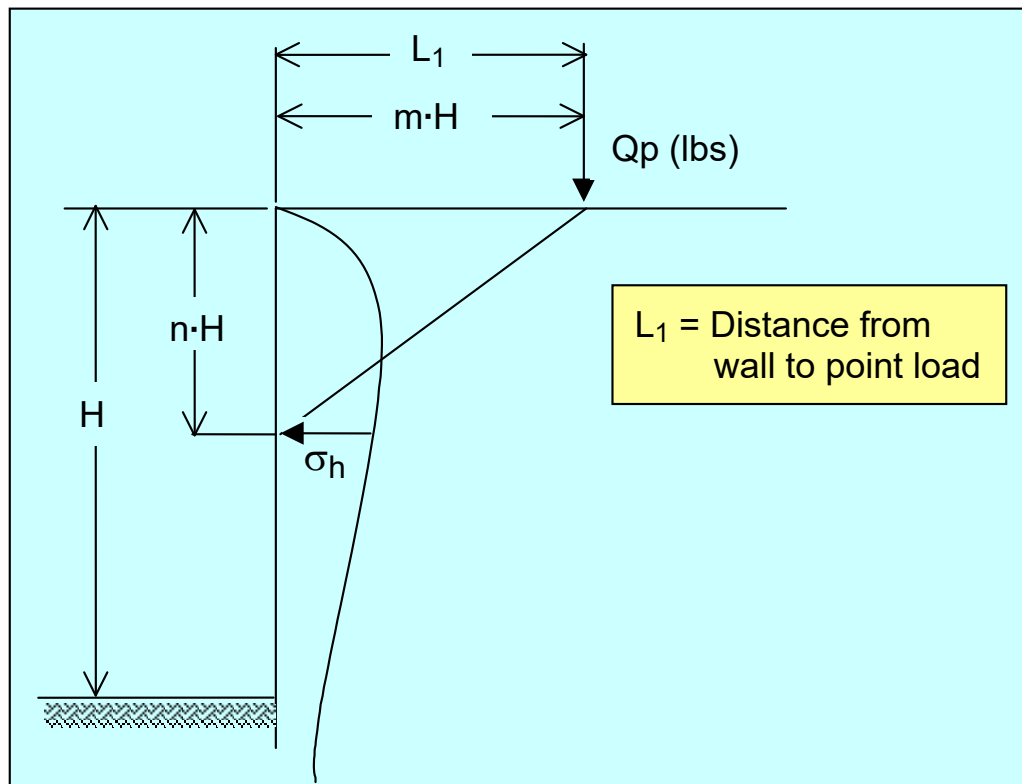

Figure 4-50. Boussinesq Type Point Load

EARTH PRESSURE THEORY AND APPLICATION

In addition, σ_h is further adjusted by the following when the point is further away from the line closest to the point load: (see Figure 4-51)

$$\sigma'_h = \sigma_h \cos^2[(1.1)\theta] \quad \text{Eq. 4-72}$$

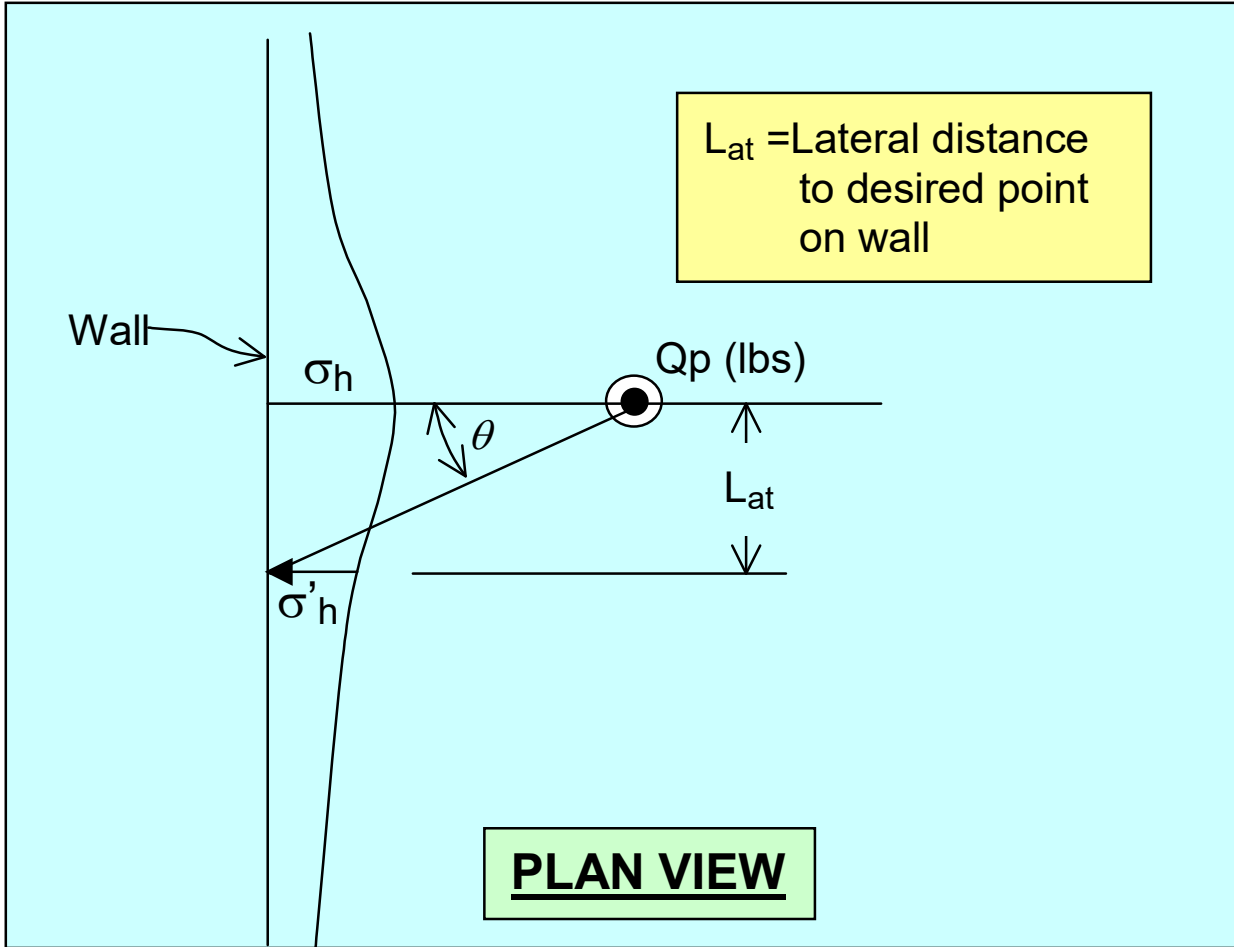

Figure 4-51. Boussinesq Type Point Load with Lateral Offset

4.8.4 Traffic Loads

Traffic near an excavation is one of the more commonly occurring surcharge loads. Trying to analyze every possible scenario would be time consuming and not very practical. For normal situations, a surcharge load of 300 psf spread over the width of the traveled way should be sufficient.

The following example compares the pressure diagrams for a HS20 truck. (using point loads) centered in a 12' lane to a load of $Q = 300$ psf (using the Boussinesq Strip method). The depth of excavation is 10'.

$$x_1 = m_1 H$$

$$\therefore m_1 = 12/10 = 1.2$$

$$x_2 = m_2 H$$

$$\therefore m_2 = 6/10 = 0.6$$

$$n = \text{depth}/H$$

Depth	n
2'	0.2
4'	0.4
6'	0.6
8'	0.8
10'	1.0

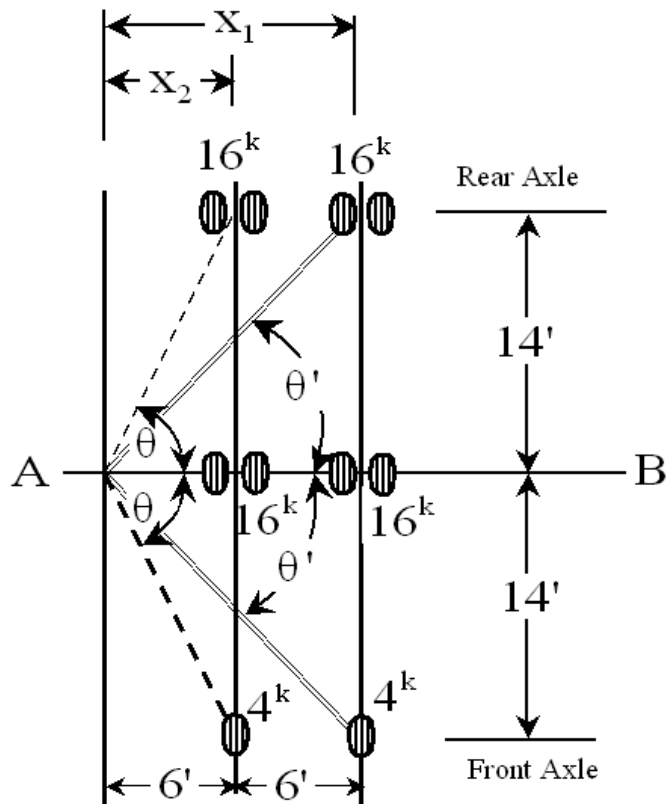

For line AB, see Eq. 4-71. For loads at an angle to AB, see Eq. 4-72.

EARTH PRESSURE THEORY AND APPLICATION

Front and rear right wheels: $\theta = 66.8^\circ, \therefore \cos^2[(1.1)(66.8^\circ)] = 0.08$

Front and rear left wheels: $\theta = 49.4^\circ, \therefore \cos^2[(1.1)(49.4^\circ)] = 0.34$

- 1.) Right rear wheels: $\sigma_h = \frac{(0.08)(1.77)(16,000)(0.6^2)(n^2)}{10^2(0.6^2 + n^2)^3}$
- 2.) Left rear wheels: $\sigma_h = \frac{(0.34)(1.77)(16,000)(1.2^2)(n^2)}{10^2(1.2^2 + n^2)^3}$
- 3.) Right center wheels: $\sigma_h = \frac{(1.77)(16,000)(0.6^2)(n^2)}{10^2(0.6^2 + n^2)^3}$
- 4.) Left center wheels: $\sigma_h = \frac{(1.77)(16,000)(1.2^2)(n^2)}{10^2(1.2^2 + n^2)^3}$
- 5.) Right front wheels: $\sigma_h = \frac{(0.08)(1.77)(4,000)(0.6^2)(n^2)}{10^2(0.6^2 + n^2)^3}$
- 6.) Left front wheels: $\sigma_h = \frac{(0.34)(1.77)(4,000)(1.2^2)(n^2)}{10^2(1.2^2 + n^2)^3}$

Combine and simplify similar equations:

$$\text{a.) } \sigma_H = \frac{(112.2)(n^2)}{(0.36 + n^2)^3}$$

$$\text{b.) } \sigma_H = \frac{(581.1)(n^2)}{(1.44 + n^2)^3}$$

Depth	n	a.) σ_H	b.) σ_H	$\sum \sigma_H$
0'	0.0	0.0	0.0	0.0
2'	0.2	70.1	7.2	77.3
4'	0.4	127.7	22.7	150.4
6'	0.6	108.2	35.9	144.1
8'	0.8	71.8	41.3	113.1
10'	1.0	44.6	40.0	84.6

CT TRENCHING AND SHORING MANUAL

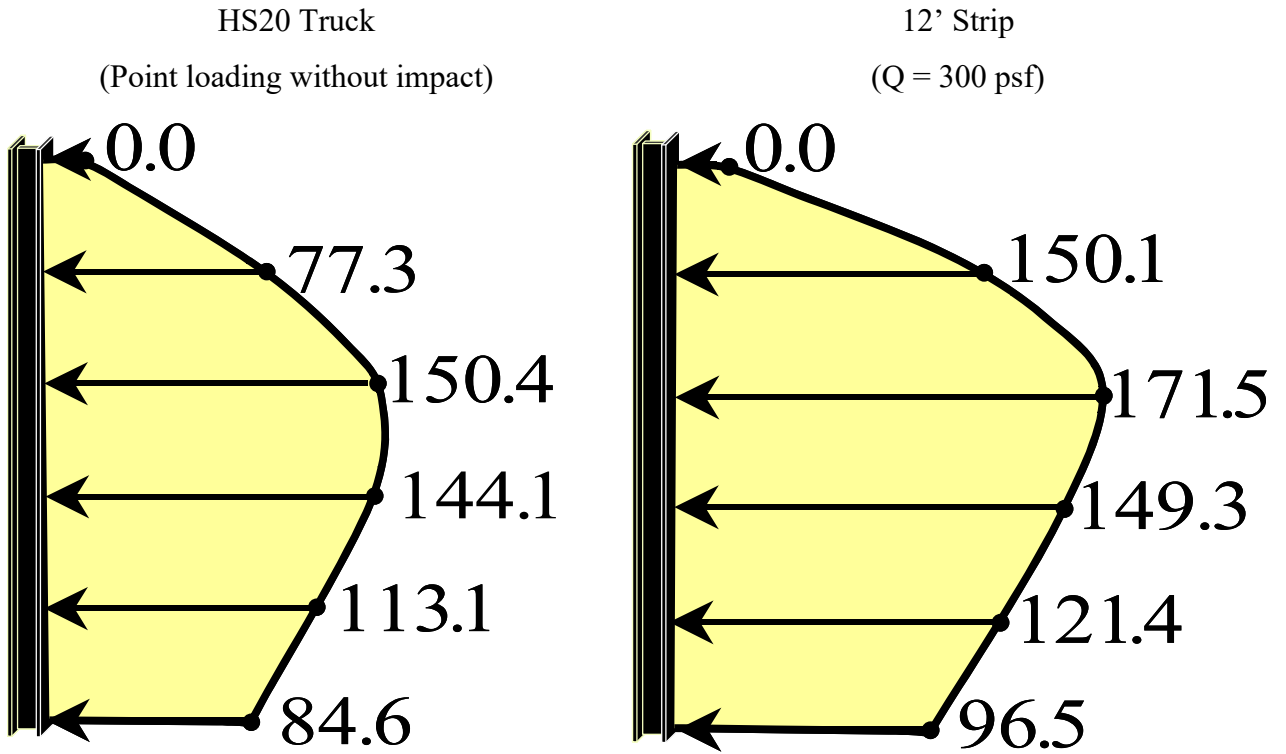

CONCLUSION: Strip load of $Q = 300$ psf compares favorably to a point load evaluation for HS20 truck loadings.

4.8.4.1 Example 4-7 Sample Problem – Surcharge Loads

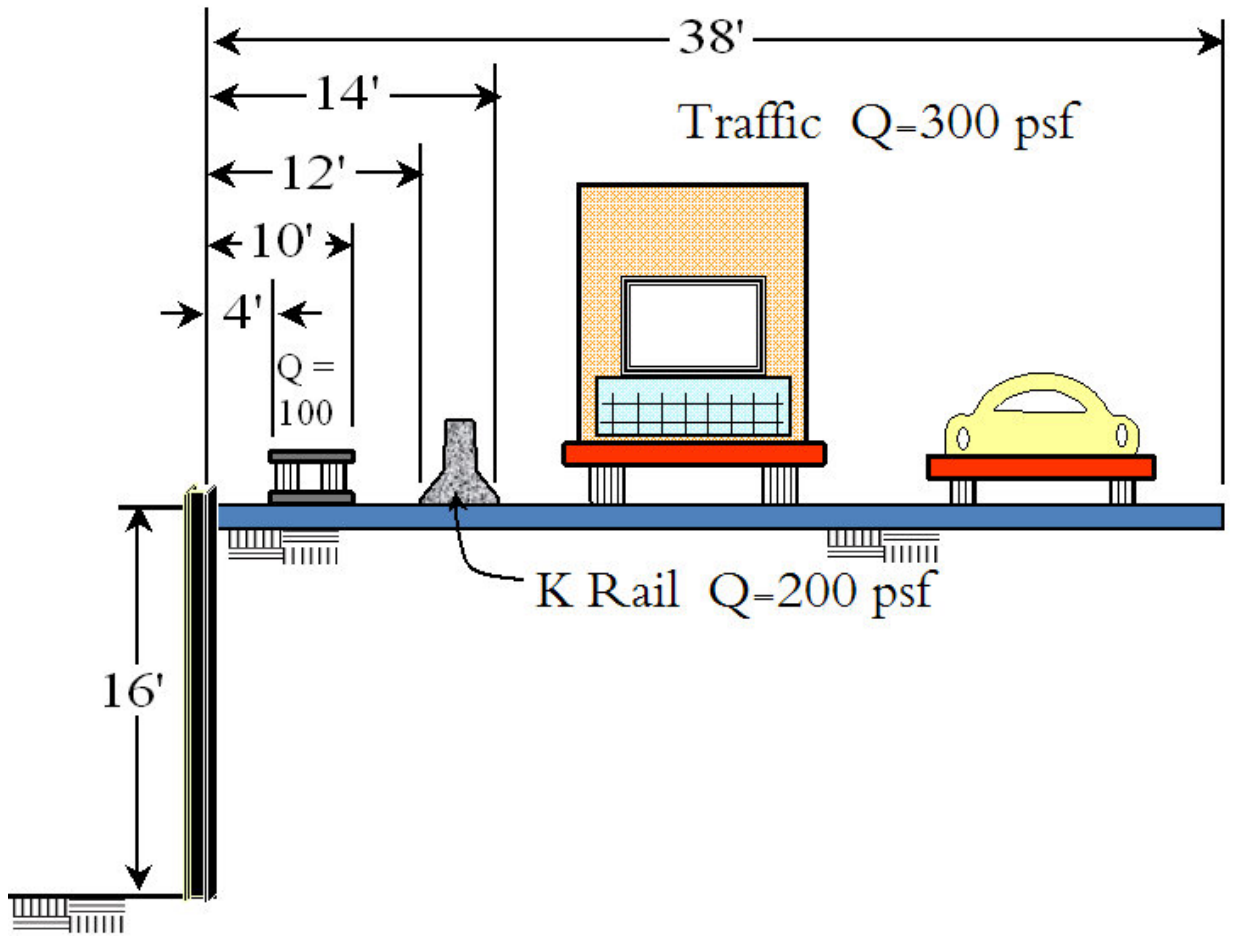

Example 4-7. Surcharge Loads

Surcharge Lateral Pressures (psf)

Depth	Q = 100	Q = 200	Q = 300	Sum
0.1	1.9	0.3	1.7	72*
1	17.9	3.0	17.1	72*
2	30.2	5.8	33.8	72*
4	35.7	10.1	63.7	109.5
6	29.5	12.3	87.1	128.9
8	21.9	12.7	103.3	137.9
10	15.9	11.9	112.6	140.4
12	11.5	10.5	116.4	138.4
14	8.5	9.0	116.1	133.6
16	6.3	7.6	112.9	126.8

* Minimum construction surcharge load.

Add soil pressures of surcharge loads to derive combined pressure diagram.

4.8.5 Alternate Surcharge Loading (Traffic)

An acceptable alternative to the Boussinesq analysis described below consists of imposing imaginary surcharges behind the shoring system such that the resulting pressure diagram is a rectangle extending to the computed depth of the shoring system and of a uniform width of 100 psf. Generally, alternative surcharge loadings are limited to traffic and light equipment surcharge loads. Other loadings due to structures, or stockpiles of soil, materials or heavy equipment will need to be considered separately.

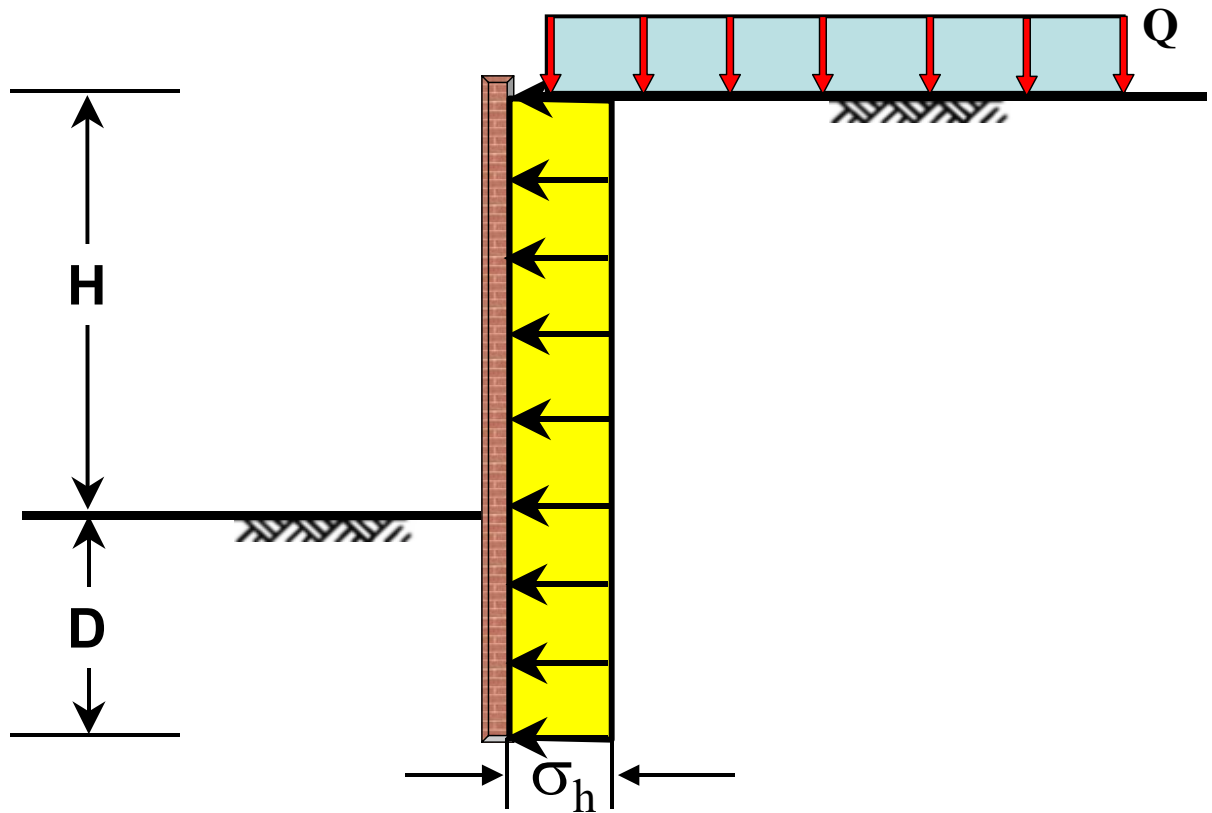

Figure 4-52. Alternate Traffic Surcharge Loading

CHAPTER 5

STRUCTURAL DESIGN OF SHORING SYSTEMS



5.0 INTRODUCTION

It is OSC practice to review the trenching and shoring problems using Allowable Stress Design (ASD) as specified in the Standard Specifications for falsework design, the Construction Safety Orders and the Manual of Railway Engineering (AREMA). This chapter summarizes the allowable values that the reviewer should use for timber and structural steel. For aluminum and concrete members use the latest acceptable national standard. For timber connections use the current National Design Specification for Wood Construction (NDS) printed by National Forest Products Association. Historically, these allowable values have provided shoring systems that are rigid and strong to support the earth pressures due to dry and/or saturated soils.

5.1 ALLOWABLE WORKING STRESSES

5.1.1 Timber

The Construction Safety Orders Appendix C to Section 1541.1(See Appendix A) defines minimum timber member sizes to use in a shoring system consisting of uprights, wales, and cross bracing members for excavations up to 20 feet depth. Member substitutions for shoring systems to be used in conjunction with the timber tables of Appendix C to Section 1541.1 require that they be manufactured members of equivalent strength. Some alternate cross bracing manufactured members are shown in Appendix E to Section 1541.1 of the Safety Orders.

For timber shoring analysis you may reference the most recent version of the NDS for Wood Construction Manual to obtain allowable working stresses.

When shoring plans designed by a qualified engineer do not specify stress limitations or list type of lumber (timber), OSC will review the plans assuming Douglas Fir Larch (North) Group II with the following stress limitations:

$F_{c } = 480,000 (L/D)^2$ psi	Compression Parallel to Grain Not to exceed 1,600 psi
$F_b = 1,800$ psi	Flexural (bending) Reduced to 1,500 psi for members with a nominal depth of 8 inches or less.
$F_t = 1,200$ psi	Direct Tension

$F_{C\perp} = 450$ psi	Compression Perpendicular to Grain
$V = 140$ psi	Horizontal Shear
$E = 1.6 \times 10^6$ psi	Modulus of Elasticity Use 1.2×10^6 psi for wet or green-timber

Lesser stress values shown on the shoring plans or in the accompanying calculations will be used for review.

When lumber (timber) type is listed or shown on the shoring plan without allowable stress values the NDS will be used as a guide. If the specific lumber grading is not included, use the lowest allowable NDS stress values.

Railroads allow 1,710 psi maximum in lieu of 1,800 psi for flexural stress for Douglas Fir-Larch, Dense Select Structural timber. Shoring adjacent to railroads is to be designed and reviewed in accordance with railroad requirements. Specific railroad requirements can be found in the AREMA Manual for Railway Engineering, Chapter 7, Section 2.13 Temporary Structures and are included in CHAPTER 8 of this Manual.

5.1.2 Steel

The maximum allowable stresses, generally, are based on the assumed use of structural steel conforming to ASTM Grade A36. Since, in general, the load carrying capacity of steel beams will be limited by stress, not deflection, the use of higher strength steels may be beneficial. However, since there are no specifications to cover the design stress criteria, the following information may be used for rolled steel sections or you may refer to current AISC specifications.

If grade of steel is unknown, use A36 ($F_y = 36$ ksi, $E = 30 \times 10^6$ psi).

For determining allowable shear stress the following equation is used:

$$F_v = 0.4 F_y \tag{Eq. 5-1}$$

For determining allowable bending stresses for steel members, (excluding sheet piles) the AISC requirements for ASD are used. For vertical shoring elements such as W or HP sections, it is assumed that the entire length of the beam is laterally supported due to the lagging. Therefore, determining the allowable bending stress, F_b , is based on this assumption. The

STRUCTURAL DESIGN OF SHORING SYSTEMS

allowable bending stresses for rolled steel sections are based on how the member is classified; as a compact, non-compact, or partially compact section based on the following criteria:

For Compact Sections the following criteria must be met:

$$\frac{b_f}{2t_f} \leq \frac{65}{\sqrt{F_y}} \text{ and } \frac{h}{t_w} \leq \frac{640}{\sqrt{F_y}}$$

For Non compact Sections the following criteria must be met:

$$\frac{65}{\sqrt{F_y}} < \frac{b_f}{2t_f} \leq \frac{95}{\sqrt{F_y}} \text{ and } \frac{640}{\sqrt{F_y}} < \frac{h}{t_w} \leq \frac{970}{\sqrt{F_y}}$$

Therefore, the allowable bending stress, F_b , is determined as the following:

Table 5-1. Laterally Supported Beams

<p>Non Compact Flange</p> $\frac{65}{\sqrt{F_y}} < \frac{b_f}{2t_f} \leq \frac{95}{\sqrt{F_y}}$ <p>Non Compact Web</p> $\frac{640}{\sqrt{F_y}} < \frac{h}{t_w} \leq \frac{970}{\sqrt{F_y}}$	Non Compact Section	$F_b = 0.6 F_y$
<p>Non Compact Flange</p> $\frac{65}{\sqrt{F_y}} < \frac{b_f}{2t_f} \leq \frac{95}{\sqrt{F_y}}$ <p>Compact Web</p> $\frac{h}{t_w} \leq \frac{640}{\sqrt{F_y}}$	Partially Compact Section	$F_b = F_y * \left[0.79 - 0.002 * \frac{b_f}{2 * t_f} * \sqrt{F_y} \right] \leq 0.66 * F_y$
<p>Compact Flange</p> $\frac{b_f}{2t_f} \leq \frac{65}{\sqrt{F_y}}$ <p>Compact Web</p> $\frac{h}{t_w} \leq \frac{640}{\sqrt{F_y}}$	Compact Section	$F_b = 0.66 F_y$
<p>Compact Flange</p> $\frac{b_f}{2t_f} \leq \frac{65}{\sqrt{F_y}}$ <p>Non compact Web</p> $\frac{640}{\sqrt{F_y}} < \frac{h}{t_w} \leq \frac{970}{\sqrt{F_y}}$	Non compact Section	$F_b = 0.6 F_y$

Please refer to AISC for beam conditions where the compression flange is not fully supported.

CT TRENCHING AND SHORING MANUAL

For determining critical flange buckling stress, the following formula may be used:

$$f \text{ (maximum)} = \frac{12,000,000}{\frac{Ld}{bt}}$$

Where:

- L = unsupported length.
- d = depth of the member
- bt = area of the compression flange.

The above value is limited to no more than 22,000 psi for unidentified steel. For identified steel the above value should be limited to the criteria for compact and non-compact sections as discussed above.

Steel sheet piling: use Grade A328 steel for which $F_b = 25$ ksi, unless specific information is furnished for a higher grade steel.

For determining the allowable axial compressive stress on a steel member with pinned ends, the following formula may be used for A36 steel only:

$$\frac{P}{A} = 16,000 - 0.38 \left(\frac{L}{r} \right)^2$$

r = least radius of gyration of the section
L = unsupported length
L/r maximum is limited to 120

For A50 grade steel: $\frac{P}{A} = 22,000 - 0.74 \left(\frac{L}{r} \right)^2$

For web crippling, the allowable stress is 27,000 psi.

For the analysis of bi-axial bending, OSC best practice requires investigation when the cross slope or cant of a beam is greater than 2%. For additional details see the OSC Falsework Manual.

For bolted connections use the most current version of the AISC Manual.

The strength of fillet welded connections may be approximated by assuming a value of 1,000 lbs per inch for each 1/8 inch of fillet weld.

Railroads have different allowable stress requirements. See CHAPTER 8 Railroad of this Manual. (Section 8.1.5.7 Structural Integrity.)

5.2 MECHANICS OF STRESS ANALYSIS

Use the accepted structural mechanics formulas and theories. Check member of the shoring system for flexure, shear, compression, and bearing. Check the system (with soil) for stability. Approximate calculations are satisfactory for most shoring systems.

Common structural mechanics formulas:

Flexural stress (bending)

$$f_b = \frac{M}{S} \text{ or } \frac{Mc}{I}$$

M = Bending Moment
 S = Section Modulus
 c = distance from the neutral axis to extreme fiber
 I = moment of inertia of section about the neutral axis

Axial Compression

$$f_c = \frac{P}{A}$$

P = Applied Load
 A = Area of Member

Timber

Compression \perp grain

$$f_{\perp} = \frac{P}{A}$$

Horizontal Shear

$$f_v = \frac{(1.5)(w)\left(\frac{L}{2} - \frac{b}{2} - d\right)}{A}$$

L = span length (center to center)
 b = thickness of supporting member or length of bearing stress area, whichever is less
 d = depth of member for which shear is being investigated
 w = unit load

CT TRENCHING AND SHORING MANUAL

Steel

Shear

$$v = \frac{V}{(h * t_w)}$$

V = is the vertical shear
h = overall depth of the beam
(out to out of the beam
flanges).

t_w = the thickness of the beam
web

Web Crippling*

For end reactions

$$f = \frac{R}{(a + k)(t_w)}$$

R = concentrated load or end
reaction

For interior reactions

$$f = \frac{R}{(a + 2k)(t_w)}$$

a = length of bearing
k = distance from the outer
face to the flange to the
web toe of fillet.

* AISC 9th Edition
redefines this as
Web Yielding

All dimensions are in inches.

For lagging, use simple span moments. Multiply all loads by 0.6 to account for soil arching.

$$M = (0.6) \frac{wL^2}{8}$$

In many cases the effective span for lagging will be less than the spacing of the supports.

For additional information on lagging see section 5.4 LAGGING in this chapter.

For interior moments of uniformly loaded continuous uprights, walers, or rails, then the following formula may be used:

$$M = \frac{wL^2}{10}$$

For cantilevers use:

$$M = \frac{wL^2}{2}$$

The Design Earth Pressure Diagram will be the sum of the basic earth pressure, surcharge loads, and any other applicable loads (such as ground water).

Since calculating earth pressures is not precise, an irregular-shaped composite diagram may be simplified by using standard geometrical shapes (rectangles, triangles, etc.).

5.3 OVERSTRESS

Short term increases to allowable stresses are allowed (to a maximum of 133%) except in the following situations when:

1. Excavations are in place more than 90 days.
2. Dynamic loadings are present (pile driving, traffic, etc).
3. Excavations are adjacent to railroads.
4. Analyzing horizontal struts.

5.4 LAGGING

Lagging is placed between the flanges of either wide flange (W) or HP piles. The practice of installing lagging behind the back flange of the soldier piling is not recommended because the potential arching action of the supported soil will be destroyed. Also, the unsupported length of the compression flange of the beam will be affected. Lagging placed behind the front flange may be wedged back to provide tight soil to lagging contact. Voids behind lagging should be filled with compacted material. Lagging may be installed with a maximum spacing up to 1½ inches between lagging members to permit seepage through the wall system. Movement of soil through the lagging spaces can be prevented by placing or packing straw, hay or similar material into the spaces. Filter fabric behind the lagging members is usually used for permanent structures.

The lagging bridges and retains soil between piles and transfers the lateral soil load to the soldier pile system. Due to the flexibility of the lagging and the soil arching capability, as shown in Figure 5-1, multiplying the maximum earth pressure by a reduction factor of 0.6 reduces the soil pressure distribution behind the lagging.

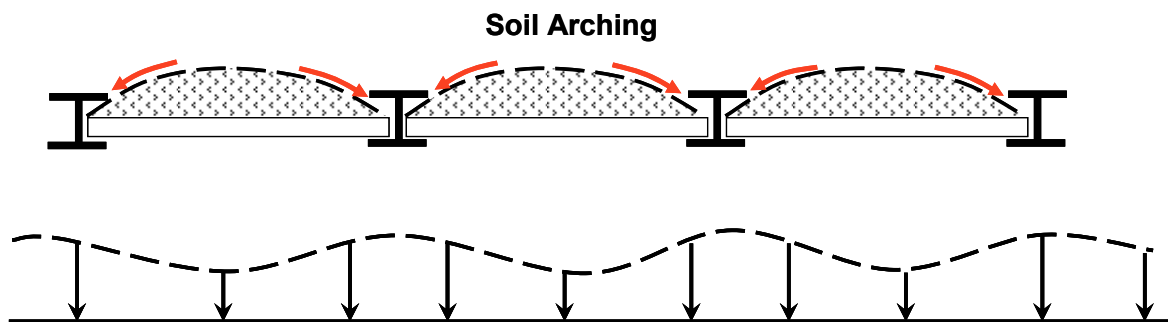

Figure 5-1. Soil Arching

CT TRENCHING AND SHORING MANUAL

Construction grade lumber is the most common material used for lagging. Treated lumber is beneficial to use when it is expected that the lagging will remain in place for a long period of time, or permanently. If the use of treated lumber is proposed, check to see that it complies with your contract and permit requirements, especially in and near water sources.

Lateral soil movement within the failure wedge induces soil arching behind lagging. This soil movement causes the lagging to flex outward. The arching process induces a redistribution of soil pressure away from the center of the lagging toward the much stiffer soldier pile support. Because of this, the design load on the lagging may be taken as 0.6 times the theoretical or calculated earth pressure. Studies have shown that a maximum lagging pressure of 400 psf should be expected when surcharges are not affecting the system. Without soil arching, the pressure redistribution would not occur and reduced lagging loads should not be considered. For the arching effect to occur the backside of the soldier pile must bear against the soil.

- Lagging design load = 0.6 (shoring design load).
- Maximum lagging load may be 400 psf without surcharges.

Table 5-2 lists FHWA recommended minimum timber thickness for construction grade Douglas Fir lagging for the following soil classifications.

- Competent Soils: These soils include high internal friction angle sand or granular material or stiff to very stiff clays.
- Difficult Soils: These soils consist of loose to low internal friction angle cohesionless material, silty sands, and over consolidated clays which may expand laterally, especially in deep excavations.
- Potentially Dangerous Soils: The use of lagging with potentially dangerous soils is questionable.

The tabular values may be used for lagging where soil arching behind the lagging can develop. Tabular values should not be used for excavations adjacent to existing facilities including railroads. Lagging used in conjunction with surcharges should be analyzed separately.

STRUCTURAL DESIGN OF SHORING SYSTEMS

Table 5-2. FHWA Recommended Minimum Timber Thickness

<u>RECOMMENDED THICKNESS OF WOOD LAGGING</u> <u>WHEN SOIL ARCHING WILL BE DEVELOPED*</u> (FOR LOCATIONS WITHOUT SURCHARGE LOADINGS)								
Soil Description Classification	Unified	Depth	Recommended Thickness of Lagging (rough cut) for clear spans of:					
			5'	6'	7'	8'	9'	10'
COMPETENT SOILS								
Silts or fine sand and silt above water table	ML, SM – ML							
Sands and gravels (Medium dense to dense)	GW, GP, GM, GC, SW, SP, SM	0' to 25'	2"	3"	3"	3"	4"	4"
Clays (Stiff to very stiff); non-fissured	CL, CH	25' to 60'	3"	3"	3"	4"	4"	5"
Clays, medium consistency and γ_H/C < 5.	CL, CH							
DIFFICULT SOILS								
Sands and silty sands, (loose).	SW, SP, SM							
Clayey sands (medium dense to dense) below water table.	SC	0' to 25'	3"	3"	3"	4"	4"	5"
Clays, heavily over- consolidated fissured	CL, CH	25' to 60'	3"	3"	4"	4"	5"	5"
Cohesionless silt or fine sand and silt below water table	ML; SM – ML							
POTENTIALLY DANGEROUS SOILS (appropriateness of lagging is questionable)								
Soft clays $\gamma_H/C > 5$.	CL, CH	0' to 15'	3"	3"	4"	5"		
Slightly plastic silts below water table.	ML	15' to 25'	3"	4"	5"	6"		
Clayey sands (loose), below water table	SC	25' to 35'	4"	5"	6"			
*adapted and revised from the April 1976 Federal Highway Administration Report No. FHWA-RD-130.								

CHAPTER 6

UNRESTRAINED SHORING SYSTEMS

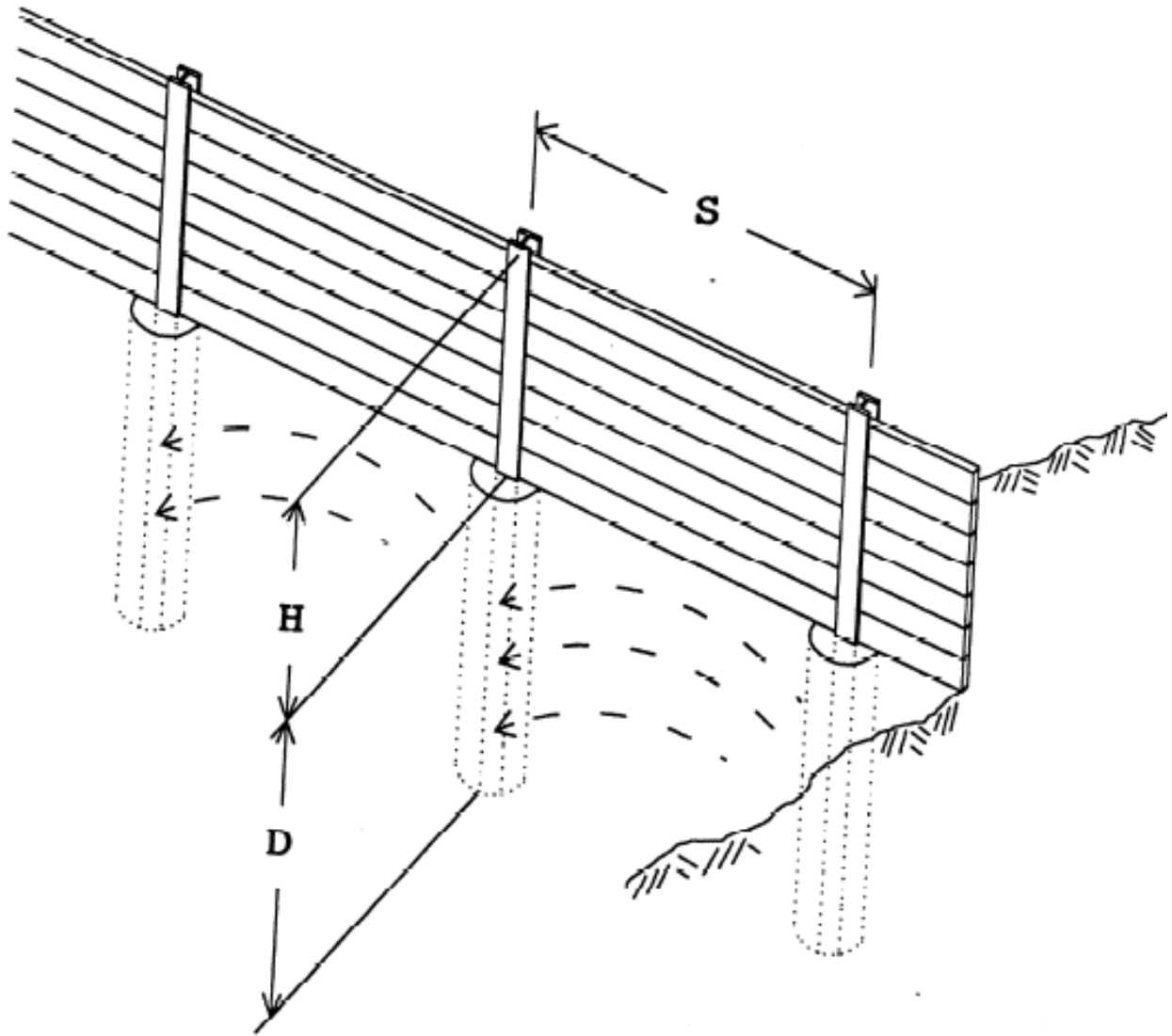

6.0 TYPES OF UNRESTRAINED SHORING SYSTEMS

There are two types of unrestrained shoring systems, sheet pile walls and soldier pile walls. Continuous sheet pile retaining walls may be constructed with driven precast prestressed concrete sheet piles or steel sheet piles with interlocking edges. The sheet piles are driven side by side into the ground and form a continuous vertical wall. Because of the large deflections that may develop, cantilever sheet pile retaining walls are mainly used for temporary excavations not greater than about 18 feet. However, the use of struts and/or walers can increase the wall height. Figure 6-1 shows a typical cantilever sheet pile retaining wall.



Figure 6-1. Sheet Pile Wall with Cap Beam

Soldier pile retaining walls may be constructed with driven piles (steel, timber or concrete) or they may be placed in drilled holes and backfilled with concrete, slurry, sand, pea-gravel or similar material. A soldier pile could also be a cast in place reinforced concrete pile. Lagging is placed between soldier pile vertical elements and could be treated timber, reinforced shotcrete, reinforced

cast in place concrete, precast concrete panels or steel plates. This type of wall depends on passive resistance of the foundation material and the moment resisting capacity of the vertical structural members for stability, therefore its maximum height is limited to competence of the foundation material and the moment resisting capacity of the vertical structural members. The economical height of this type of wall is generally limited to a maximum height of 18 feet. Figure 6-2 shows a typical soldier pile retaining wall.



Figure 6-2. Soldier Pile Wall with Cap Beam

6.1 LATERAL EARTH PRESSURES FOR UNRESTRAINED SHORING SYSTEMS

Non-gravity cantilever retaining walls are analyzed by assuming that the vertical structural member rotates at Point O, at the distance, D_o , below the excavation line as shown in Figure 6-3 (a). The realistic load distribution is shown in (b). As a result, the mobilized active pressure develops above Point O in the back of the wall and below Point O in the front of the wall. The mobilized passive pressure develops in front of the wall above Point O and at the back of the wall below Point O. The simplified load distribution is shown in Figure 6-3 (c). Force R is assumed at

UNRESTRAINED SHORING SYSTEMS

Point O to compensate the resultant net active and passive pressure below point of rotation at Point O. The calculated depth, D , is determined by increasing D_o by 20% to approximate the total embedment depth of the vertical wall element. The 20% increase is not a factor of safety, it accounts for the rotation of the length of vertical wall element below Point O as shown in Figure 6-3.

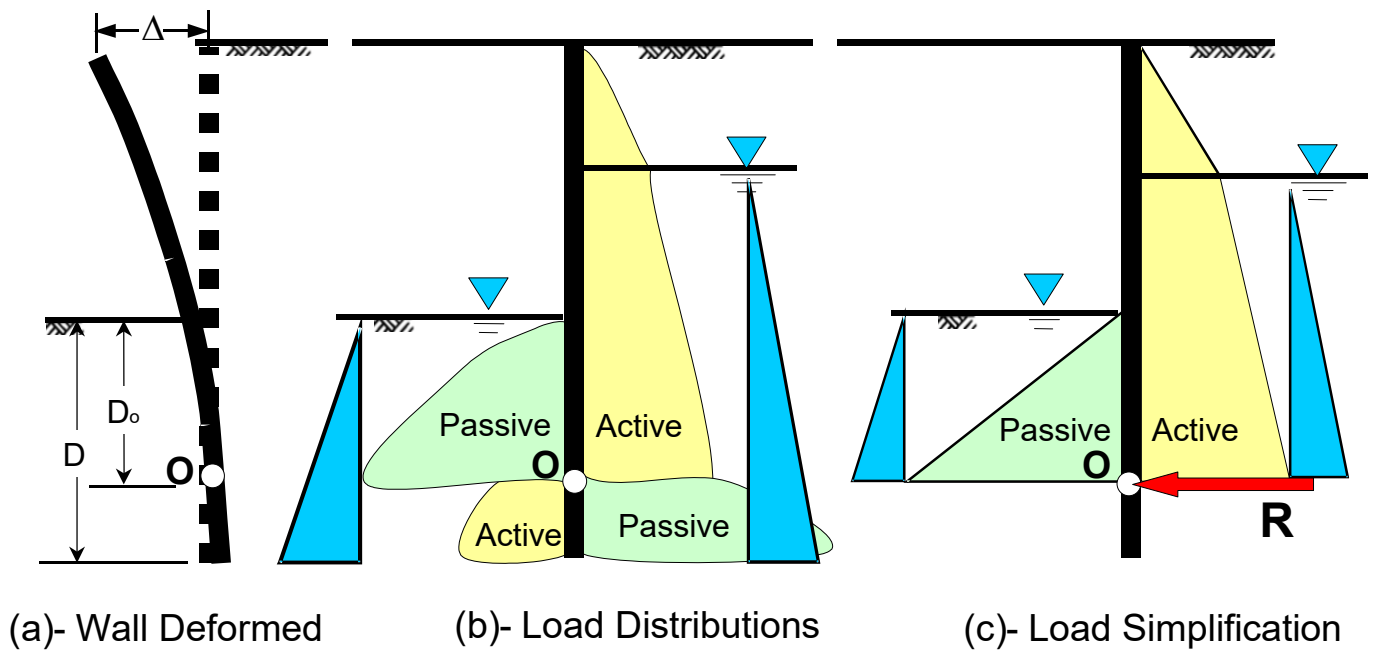

Figure 6-3. Cantilever Retaining Walls

For unrestrained shoring systems, depending on the site soil profile, the simplified lateral earth pressure distribution shown in Figure 6-4 through Figure 6-8 may be used.

For walls with vertical elements embedded in a single layer of granular soil and retaining granular soil, Figure 6-4 may be used to determine the lateral earth pressure distribution for a cantilever shoring system.

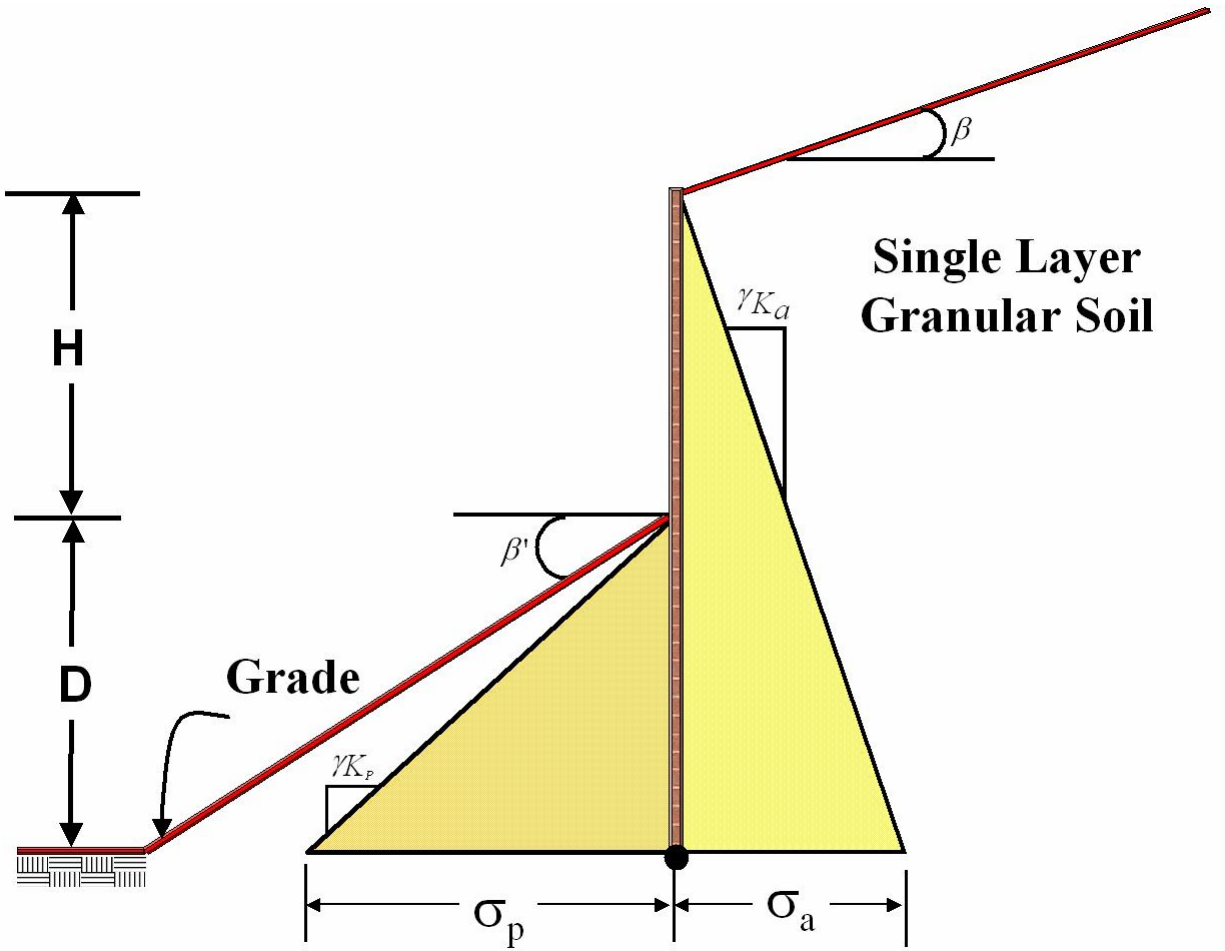

Figure 6-4. Loading Diagram for Single Layer

UNRESTRAINED SHORING SYSTEMS

For walls with vertical elements embedded in multi-layer granular soil and retaining granular soil, Figure 6-5 may be used to determine the lateral earth pressure distribution for a cantilever shoring system.

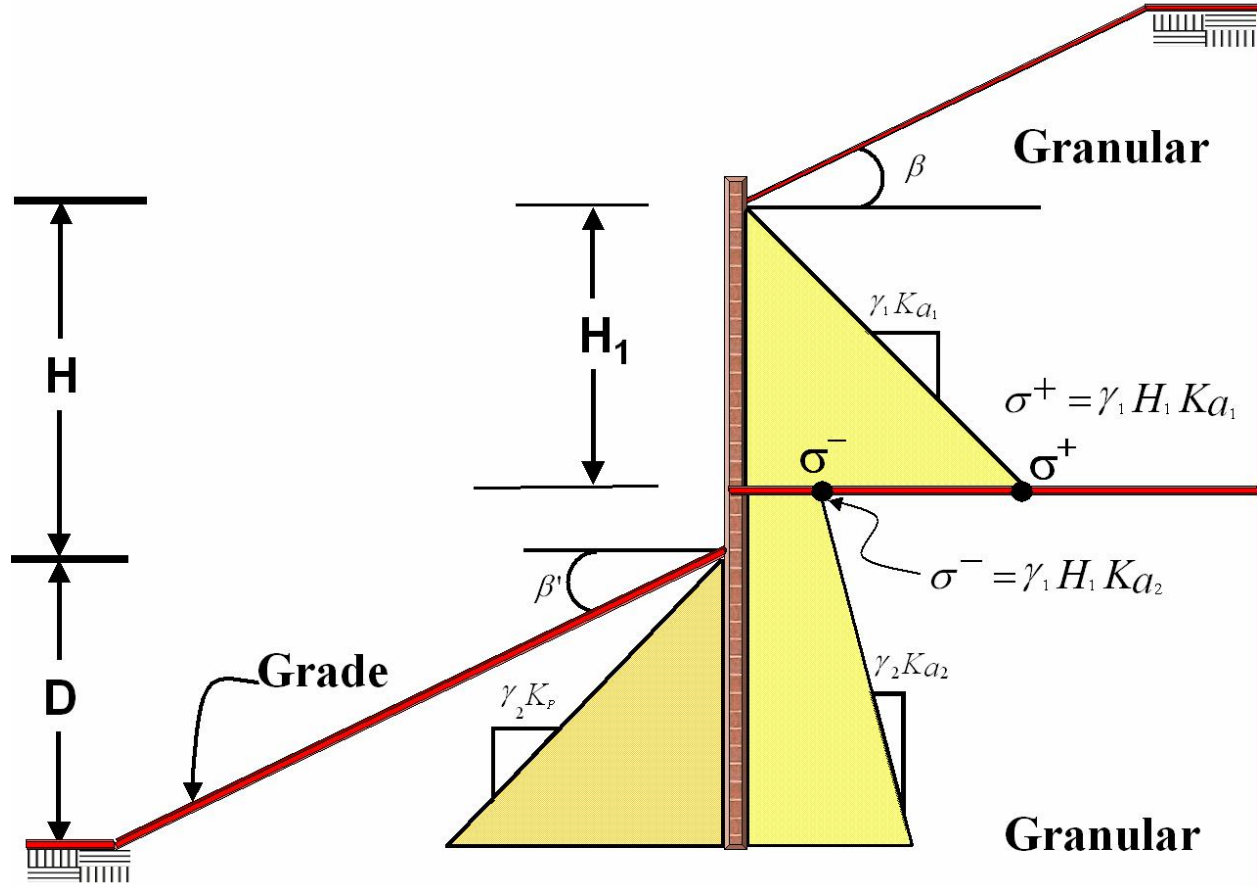

Figure 6-5. Loading Diagram for Multi-Layer Soil

If walls support or are supported by cohesive soils, the walls may be designed by the total stress method of analysis and undrained shear strength parameters. For the latter, the simplified lateral earth pressure distribution shown in Figure 6-6, Figure 6-7, and Figure 6-8 may be used.

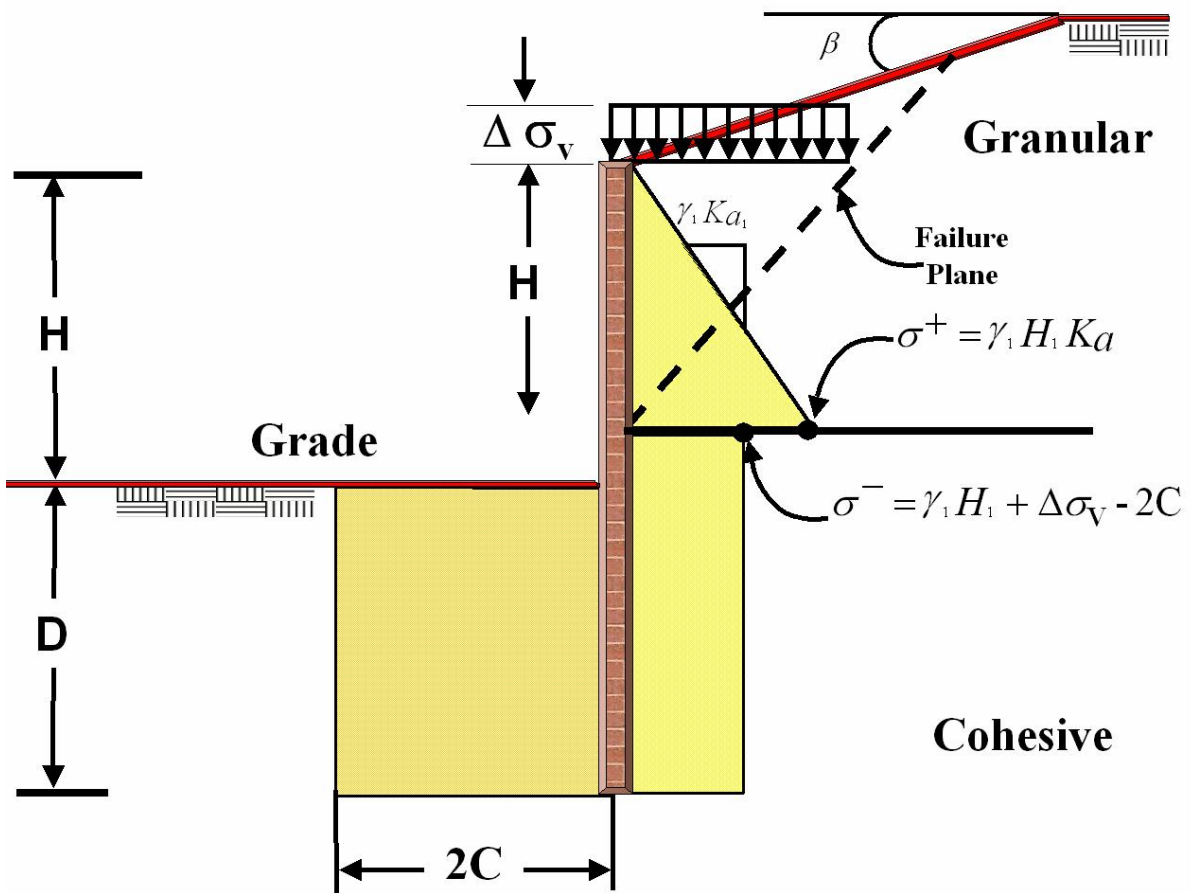

Figure 6-6. Loading Diagram for Multi-Layer

UNRESTRAINED SHORING SYSTEMS

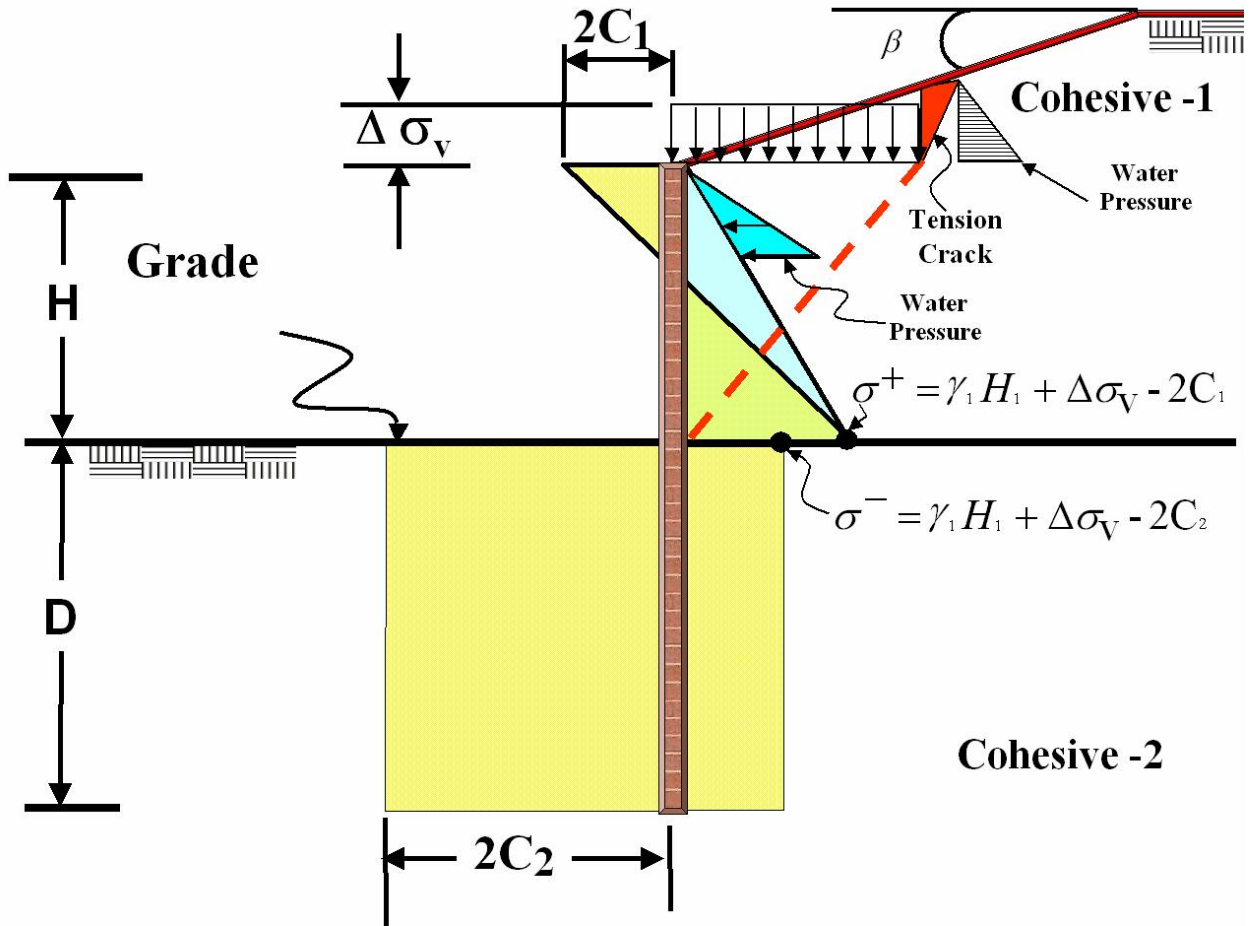

Figure 6-7. Loading Diagram for Multi-Layer

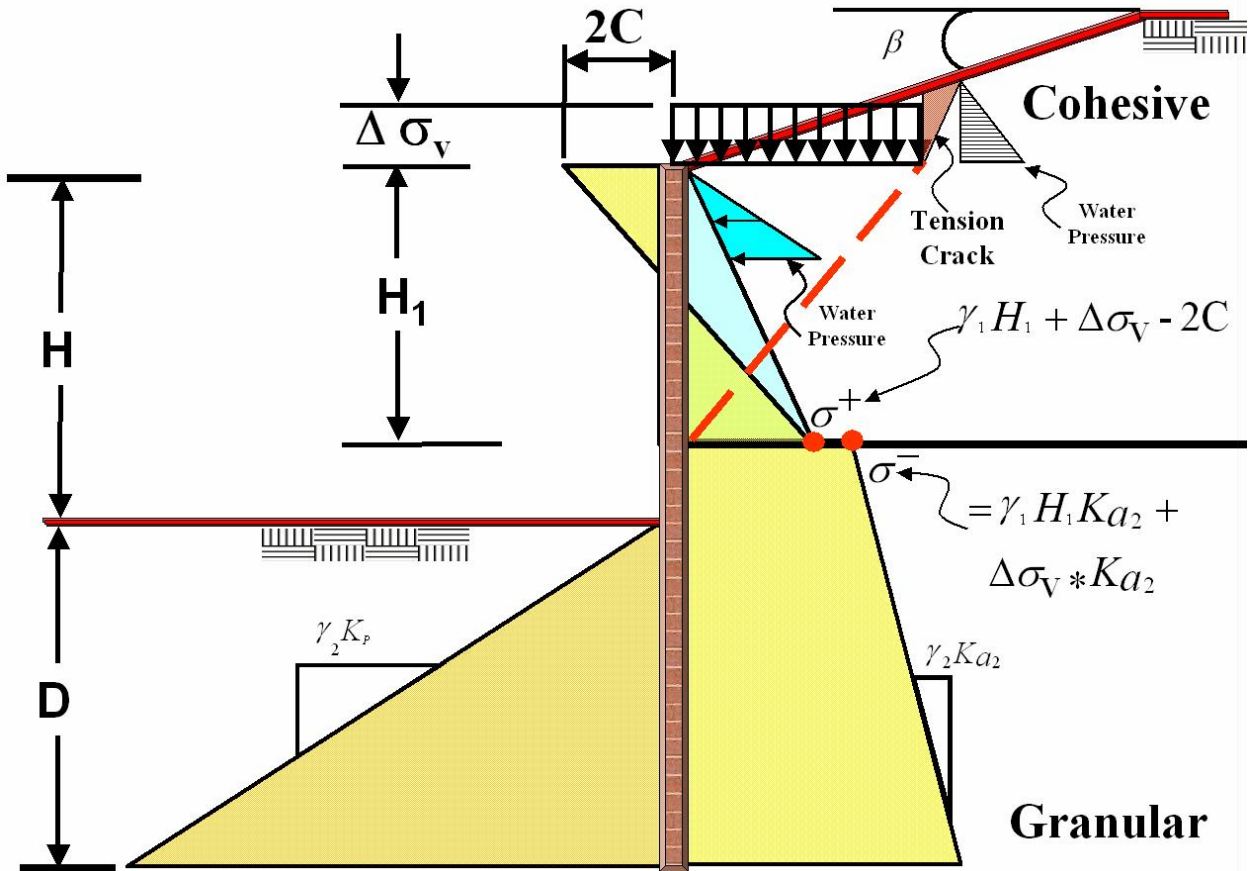

Figure 6-8. Loading Diagram for Multi-Layer

To determine the active lateral earth pressure on the embedded wall element shown above:

- Treat the sloping backfill above the top of the wall within the active failure wedge as an additional surcharge ($\Delta\sigma_v$).
- The portion of the negative loading at the top of the wall due to cohesion is ignored
- Any hydrostatic pressure in the tension crack needs to be considered.
- The ratio of total overburden pressure to undrained shear strength (NS) must be < 3 at the design grade in front of wall.
- The active lateral earth pressure acting over the wall height (H) shall not be less than 0.25 times the effective overburden pressure at any depth, or 0.036 KSF/FT of wall height, which ever is greater.

6.2 EFFECTIVE WIDTH

The effective width (d) of a soldier pile is generally considered to be the dimension of the soldier pile taken parallel to the line of the wall for driven piles or drilled piles backfilled with material other than concrete. The effective width of the soldier piles may be taken as the diameter of the drilled-hole when 4-sack or better concrete is used. Soil arching however, can greatly increase the effective width described above. See Figure 6-9. Arching of the soil between soldier piles can increase the effective width of a soldier pile up to 3 times for granular soil and 2 times for cohesive soils.

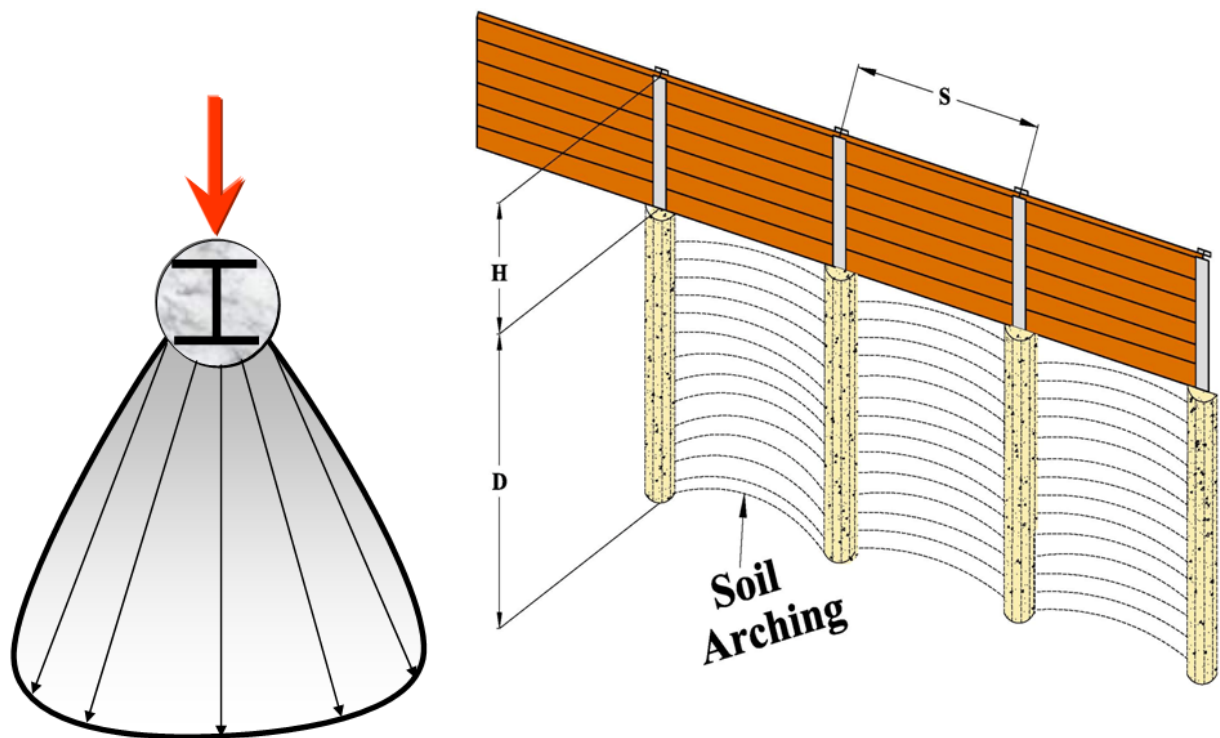

Passive Resistance Zone

Figure 6-9. Soldier Pile with Arching

Numerous full-scale pile experiments have shown the passive resistance in front of an isolated pile is a three dimensional problem as shown in Figure 6-9. Two dimensional classical earth pressure theories under estimates the passive resistance in front of a soldier pile. Therefore, the passive resistance in front of a pile calculated by classical earth pressure theories shall be multiplied by the

CT TRENCHING AND SHORING MANUAL

adjusted pile width. The adjusted pile width is a function of the effective width of the pile and the soil friction angle (ϕ) as shown below.

$$\text{Adjusted Pile Width} = \text{Effective Width} * \text{Arching Capability Factor} \quad \text{Eq. 6-1}$$

Table 6-1. Arching Capability Factor

Pile Spacing (s)	Arching Capability Factor
$\leq 3 * d$	3
$> 3 * d$	$0.08 * \phi (\leq 3)$

Where:

Effective Width = Width of the pile as described above.

d = Effective Width

ϕ = Internal friction angle of the soil in degrees

For granular soils, if the pile spacing is 3 times the effective width (d) or less the arching capability factor may be taken as 3. The arching capability for cohesive soil ranges between 1 and 2 as shown in Table 6-2.

Table 6-2. Arching Capability for Cohesive Soil

<u>CONSISTENCY</u>	<u>VERY SOFT</u>	<u>SOFT</u>	<u>MEDIUM</u>	<u>STIFF</u>	<u>VERY STIFF</u>	<u>HARD</u>
q_u = unconfined comp. strength (PSF)	500	1000	2000	4000	8000	
Unit Weight (PCF) Saturated	100-120	110-130		120-140		130+
Arching Capability	1 to 2	1 to 2	2	2	2	
VERY SOFT: Exudes from fingers when squeezed in hand. SOFT: Molded by light finger pressure. MEDIUM: Molded by strong finger pressure. STIFF: Indent by thumb. VERY STIFF: Indent by thumb nail. HARD: Difficult to indent by thumb nail.						

Below the excavation depth the adjusted pile width is used for any active loadings (including surcharge loadings) on the back of the pile as well as for the passive resistance in front of the pile. The adjusted pile width cannot exceed the pile spacing and when the adjusted pile width equals the pile spacing, soldier pile systems can be analyzed in the same manner as sheet pile systems.

6.3 DEFLECTION

Calculating deflections of temporary shoring systems can be complicated. Deflection calculations are required for any shoring system adjacent to the Railroad or high risk structures. Generally, the taller a shoring system becomes the more likely it is to yield large lateral deflections. The amount of deflection or movement that is allowable inversely proportional to the sensitivity to movement of what is being shored. Thus it will be up to the Engineer's good judgment as to what degree of analysis will be performed. Bear in mind that except for the Railroad as discussed in CHAPTER 8 of this Manual, there are no guidelines on the maximum allowable lateral deflection of the shoring system. For other high risk structures, allowable deflections are based on case by case basis.

Typical deflection calculations are normally performed per standard beam analysis methods. The deflection can either be determined from double integration of the moment diagram or by multiplying the area under the moment diagram times its moment arm beginning from the top of the pile to a depth 'D' below the dredge line. Although these methods described above are for standard beam analysis, it should be pointed out that typical shoring systems do not necessarily act as standard beams supported by point supports. Instead, for calculating a realistic deflection for a shoring system a soil-structure interaction (SSI) analysis using a p-y approach or a finite element method shall be performed. The SSI method of analysis is beyond the scope of this Manual and the Engineer is encouraged to contact the Trenching and Shoring Specialist in Sacramento.

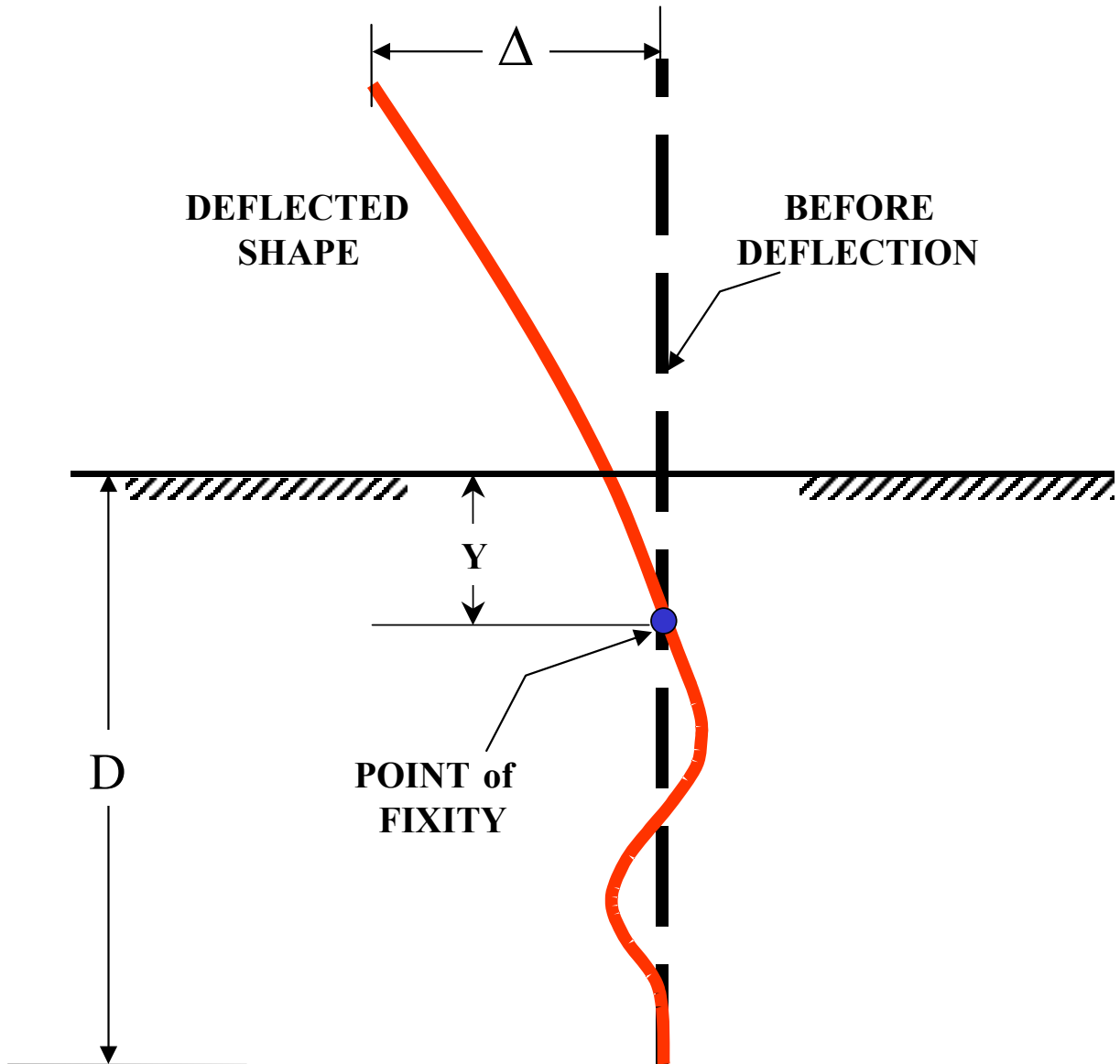

Figure 6-10. Deflected Shape for Unrestrained System

For the simple beam analysis method, one important issue that needs to be considered when calculating deflections is the Point of Fixity, or the point of zero (0) deflection, below the excavation line as shown in Figure 6-10. The Point of Fixity is defined as a percentage of the embedment depth 'D' which varies from 0 to 0.75D. For unrestrained shoring systems in most stiff to medium dense soils, a value of 0.25D may be assumed. A greater value may be used for loose sand or soft clay. It should be noted that the simple beam method of analysis alluded to above is only approximate.

6.4 SOIL PRESSURE DISTRIBUTION FOR LAYERED SOIL

For a shoring system in layered soils it is very important to develop appropriate soil pressure distribution for each individual soil layer as shown in Figure 6-11.

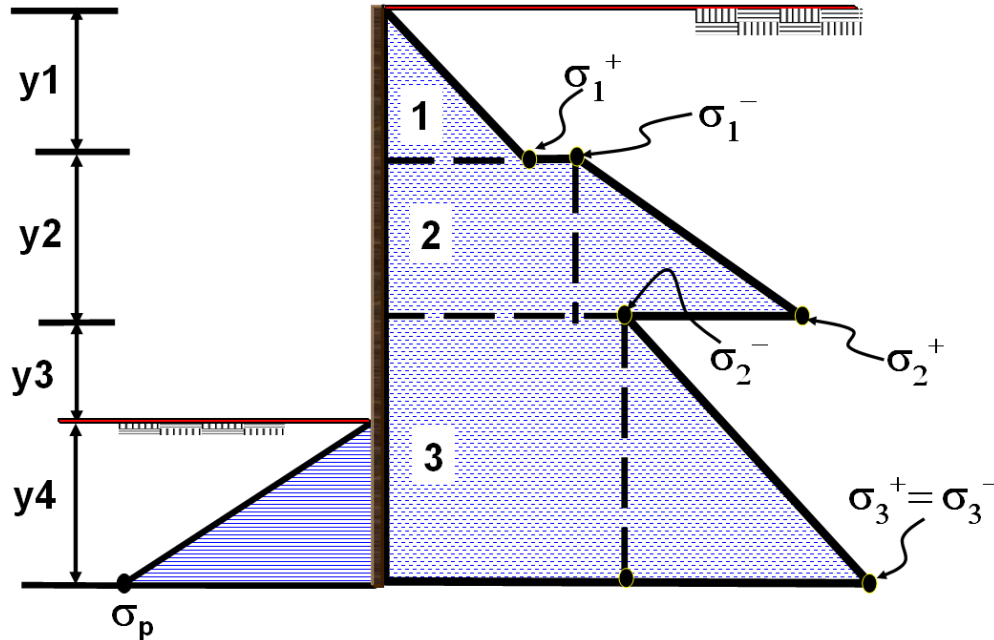

Figure 6-11. Multilayer soil pressure

The following procedure is used for the check of a Cantilever wall (see Figure 6-3):

1. Calculate Active/Passive Earth Pressure to an arbitrary point, O, at the distance, D_o , below the excavation line.
2. Take a moment about Point O to eliminate Force R and determine embedment depth D_o .
3. Increase D_o by 20 percent ($D = 1.2D_o$)
4. Calculate R by summation of forces in horizontal direction ($R \leq 0$, if R is larger than zero, increase D)
5. Calculate Maximum Bending Moment (M_{MAX}) and Maximum Shear Force (V_{MAX}) to check the vertical structural member and lagging.

6.4.1 Example 6-1 Cantilevered Soldier Pile Wall

For a shoring system subjected to the lateral load given below calculate the total required horizontal force using the Rankine earth pressure theory.

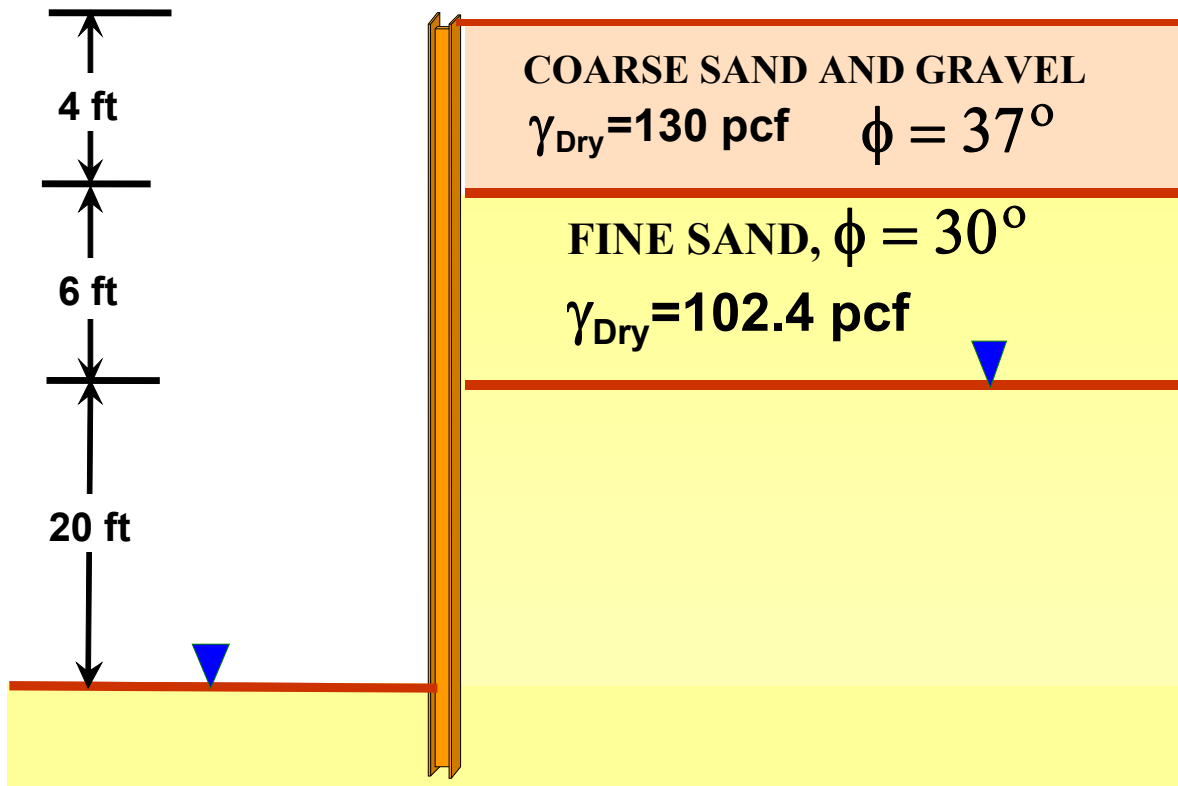

Figure 6-12. Example 6-1

Solution:

- Calculate and plot earth pressure distribution.
- Calculate the total force on the shoring system.

$$K_{a1} = \tan^2 \left(45 - \frac{\phi}{2} \right) = \tan^2 \left(45 - \frac{37}{2} \right) = 0.249$$

$$K_{a2} = \tan^2 \left(45 - \frac{\phi}{2} \right) = \tan^2 \left(45 - \frac{30}{2} \right) = 0.333$$

UNRESTRAINED SHORING SYSTEMS

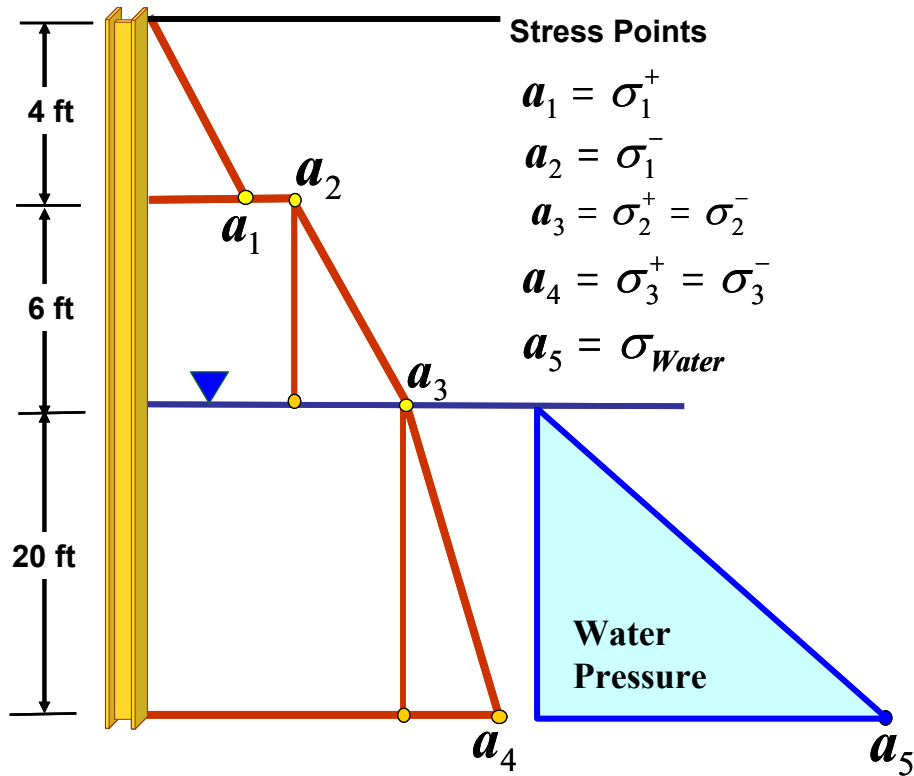

Figure 6-13. Pressure Loading Diagram

In the figure above and the analysis below, the subscripted numbers refer to the soil layer. The superscripted + refers to the stress at the indicated soil layer due the material above the layer line based on K_a of that soil. The superscripted - refers to the stress at the indicated soil layer for the material above the layer line based on the K_a of the soil below the layer line.

$$\sigma_1^+ = (130 \text{ pcf})(4 \text{ ft})(0.249) = 129.48 \text{ psf}$$

$$\sigma_1^- = (130 \text{ pcf})(4 \text{ ft})(0.333) = 173.16 \text{ psf}$$

$$\sigma_2^+ = 173.16 + (102.40 \text{ pcf})(6 \text{ ft})(0.333) = 377.76 \text{ psf}$$

$$\sigma_2^+ = \sigma_2^- = 377.76 \text{ psf}$$

$$\sigma_3^+ = \sigma_3^- = 377.76 + (102.40 - 62.40)(20)(0.333) = 644.16 \text{ psf}$$

Water Pressure

$$\sigma_{a5} = 20(62.4 \text{ pcf}) = 1,248.0 \text{ psf}$$

DRIVING FORCES:

$$F_1 = \frac{1}{2}(4 \text{ ft})(129.48 \text{ psf}) = 258.96 \text{ lb/ft}$$

$$F_2 = (6 \text{ ft})(173.16 \text{ psf}) = 1,038.96 \text{ lb/ft}$$

$$F_3 = \frac{1}{2}(6 \text{ ft})(377.76 - 173.16 \text{ psf}) = 613.80 \text{ lb/ft}$$

$$F_4 = (20 \text{ ft})(377.76 \text{ psf}) = 7,555.20 \text{ lb/ft}$$

$$F_5 = \frac{1}{2}(20 \text{ ft})(644.16 - 377.76 \text{ psf}) = 2,664.00 \text{ lb/ft}$$

$$F_6 = \frac{1}{2}(20 \text{ ft})(1248 \text{ psf}) = 12,480 \text{ lb/ft}$$

THE NET FORCES:

$$F_{\text{TOTAL}} = 24,610.92 \text{ lb/ft}$$

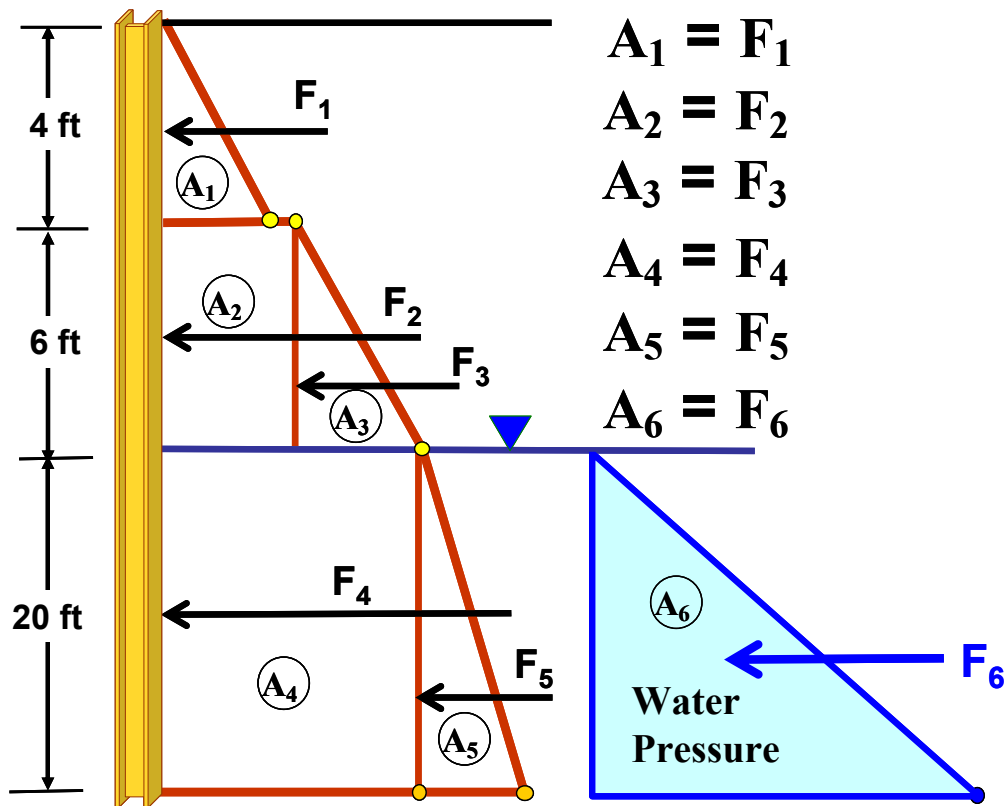

Figure 6-14. Force Loading Diagram

6.4.2 Example 6-2 Cantilevered Soldier Pile Wall

Check the adequacy of the cantilevered soldier pile wall in granular layered-soil with negative slope in the front of the wall. The soldier pile is an HP12x84 steel beam placed in a 2 feet diameter hole filled with 4 sack concrete.

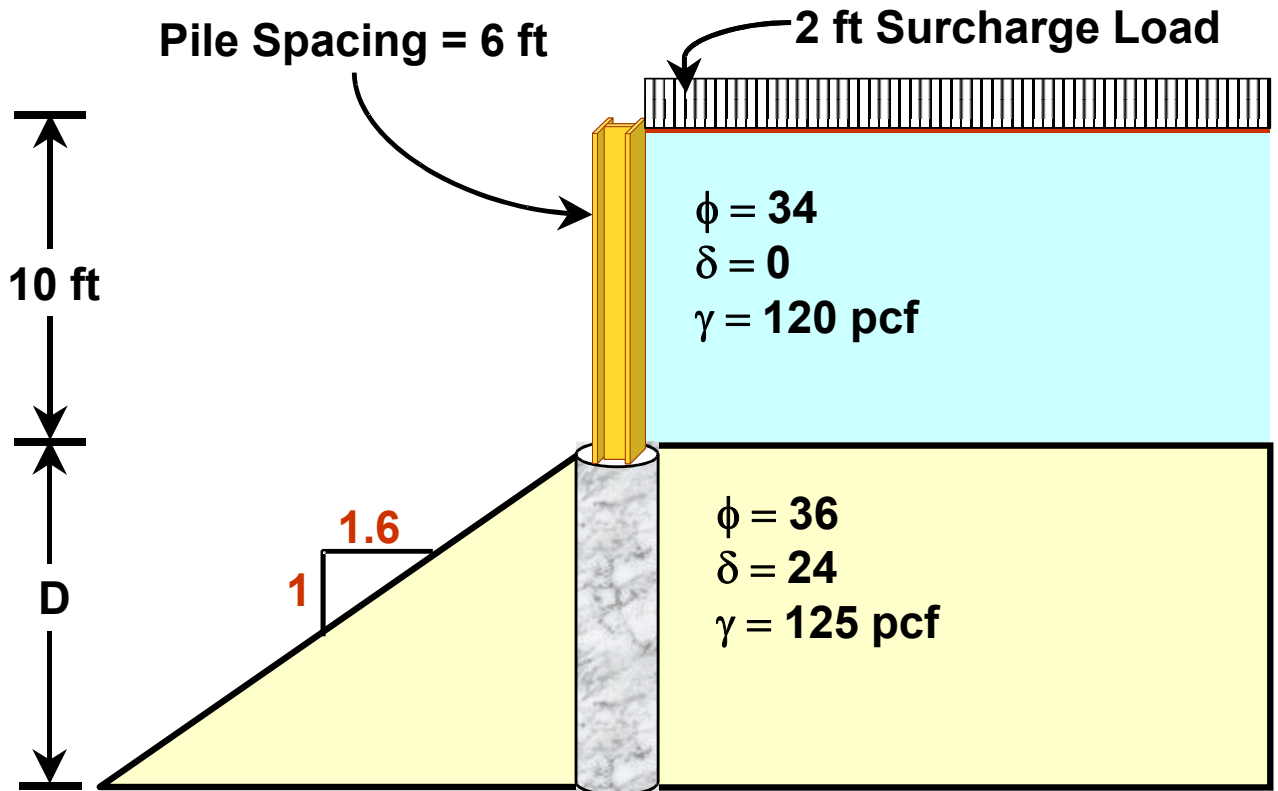

Figure 6-15. Soldier pile with sloping ground Example 6-2

For a factor of safety (FS) = 1.3

Solution:

1. Active & Passive Earth Pressures.
2. Pile Embedment D.
3. Maximum Moment.

Calculate the Active & Passive Earth Pressures:

$$K_{a1} = \tan^2\left(45 - \frac{\phi}{2}\right) = \tan^2\left(45 - \frac{34}{2}\right) = 0.283$$

Use Coulomb theory to calculate active earth pressure below the dredge line.

$$K_{a2} = \frac{\cos^2 \phi}{\cos \delta \left[1 + \sqrt{\frac{\sin(\delta + \phi) \sin \phi}{\cos \delta}} \right]^2}$$

$$K_{a2} = \frac{\cos^2(36)}{\cos 24 \left[1 + \sqrt{\frac{\sin(24 + 36) \sin 36}{\cos 36}} \right]^2} = 0.235$$

The passive horizontal earth pressure coefficient K_{ph} is calculated using Figure 4-37 as shown below:

- Calculate δ/ϕ : $24/36 = 0.67$.
- Calculate β/ϕ : $-32/36 = -0.89$.
- Determine K_p from Figure 4-37: $K_p = 1.65$
- Calculate reduction factor R using the ratio of δ/ϕ . $R = 0.8$
- Calculate K_{ph} :

$$K_{ph} = K_p * R * \cos(\delta) = 1.65 * 0.8 * \cos(24^\circ) = 1.20$$

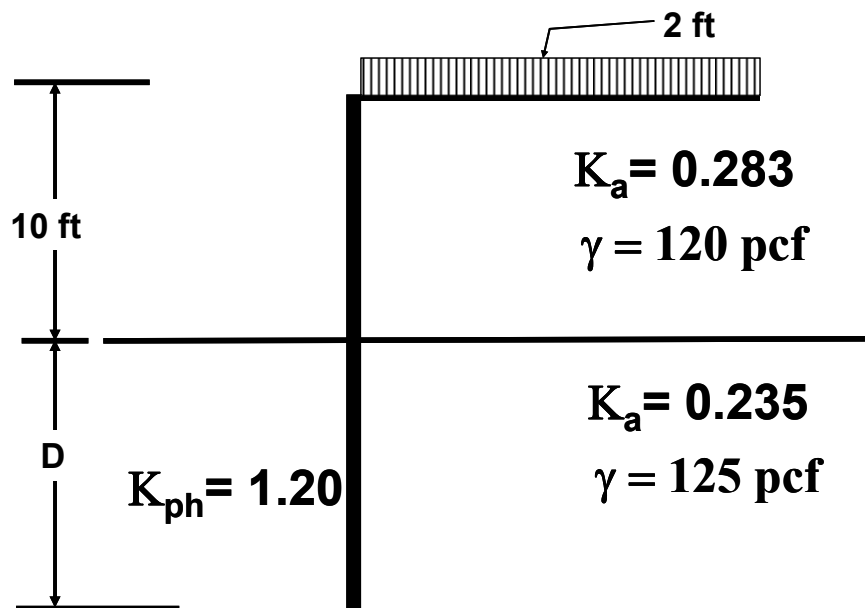

Figure 6-16. Active and Passive Earth Pressure Coefficients

UNRESTRAINED SHORING SYSTEMS

Calculate earth pressure distribution:

Lateral load due to surcharge above the excavation line only:

$$\sigma_{\text{sur}} = (120)(2)(0.283) = 68 \text{ psf use } 72 \text{ psf minimum (See Section 4.8.1)}$$

Lateral load distribution for the first layer:

$$\sigma^+ = 72 + (120)(10)(0.283) = 411.6 \text{ psf use } 412 \text{ psf}$$

Lateral load distribution for the second layer at the soil boundary:

$$k_{\text{ah}} = k_a \cos(\delta) = 0.235 * \cos(24) = 0.215$$

$$\sigma^- = (120)(10)(0.215) = 258.0 \text{ psf}$$

Lateral load distribution for the second layer at depth D:

$$\sigma_D = 258.0 + (125)(0.215)D = 258.0 + 26.88D \text{ psf}$$

Passive lateral load distribution for the second layer in the front at depth D:

$$\sigma_{\text{pD}} = (125)(1.2)D = 150.0D \text{ psf}$$

Calculate active earth pressure due to surcharge P_{AS} :

$$P_{\text{AS}} = (72)(10) = 720 \text{ plf}$$

Calculate active earth pressure for the first soil layer P_{A1} :

$$P_{\text{A1}} = \left[(412 - 72) \left(\frac{10}{2} \right) \right] = 1,700 \text{ plf}$$

Calculate active earth pressure for the second soil layer P_{A2} :

$$P_{\text{A21}} = 258.0 * D = 258.0D \text{ plf}$$

$$P_{\text{A22}} = \left[(26.88)(D) \left(\frac{D}{2} \right) \right] = 13.44D^2 \text{ plf}$$

Calculate passive earth pressure for the second soil layer P_{P} :

$$P_{\text{P}} = \left[(150)(D) \left(\frac{D}{2} \right) \right] = 75.0D^2 \text{ plf}$$

Because the pile spacing is equal to 3 times the effective width of the pile, the soldier pile wall can be analyzed in the same manner as a sheet pile wall.

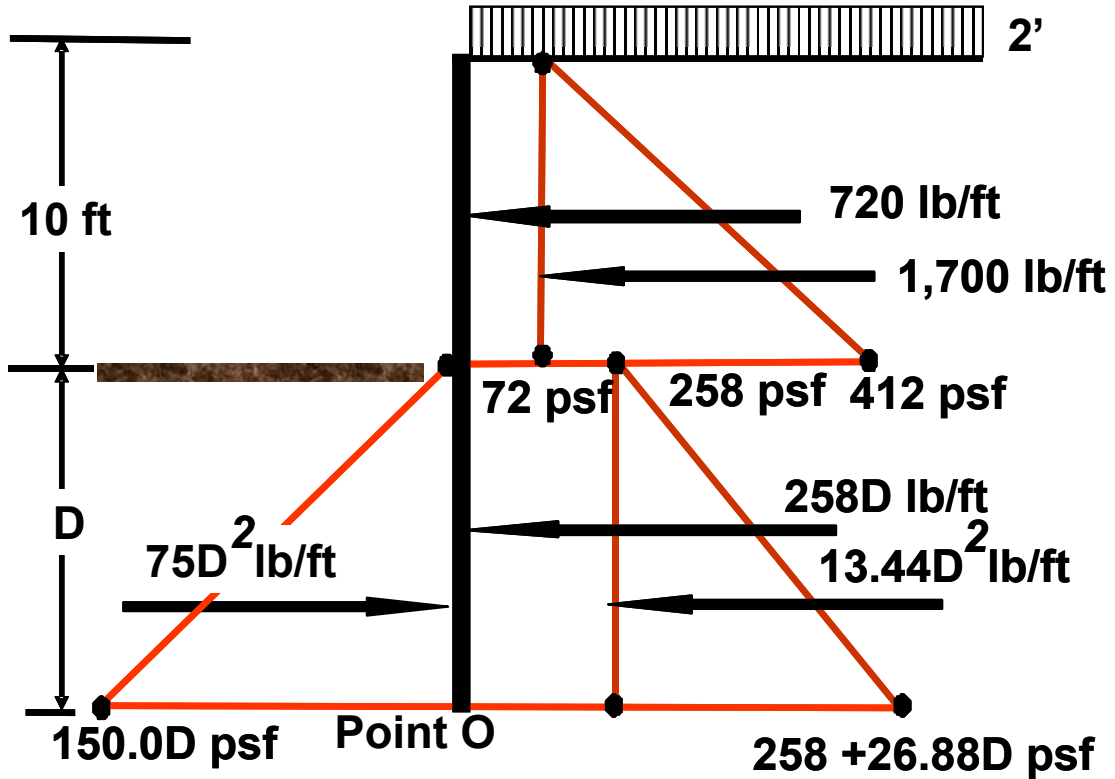

Figure 6-17. Pressure Diagram

Calculate Driving Moment (M_{DR}) and Resisting Moment (M_{RS}) about Point O.

<i>Driving Force = Pa x Spacing</i>	<i>Arm (ft)</i>	<i>Driving Moment M_{DR}</i>
$720 * 6 = 4,320$	$5 + D$	$4,320D + 21,600$
$1,700 * 6 = 10,200$	$10/3 + D$	$10,200D + 34,000$
$258 * 6 = 1,548D$	$D/2$	$774D^2$
$13.44D^2 * 6 = 80.64 D^2$	$D/3$	$26.88D^3$
<i>Resisting Force = Pp x Spacing</i>	<i>Arm (ft)</i>	<i>Resisting Moment M_{RS}</i>
$75D^2 * 6 = 450 D^2$	$D/3$	$150D^3$

$$M_{DR} = 26.88 D^3 + 774 D^2 + 14,520 D + 55,600$$

$$M_{RS} = 150 D^3$$

UNRESTRAINED SHORING SYSTEMS

Calculate embedment depth using a factor of safety (FS) equal to 1.3.

$$FS = \left[\frac{M_{RS}}{M_{DR}} \right] = 1.3$$

$$\left(\frac{150}{1.3} \right) D^3 - 26.88D^3 - 774.0D^2 - 14,520.0D - 55,600.0 = 0.0$$

$$D^3 - 8.75D^2 - 164.06D - 628.22 = 0.0 \Rightarrow D = 19.07 \text{ ft}$$

Increase D by 20%.

$$19.07 * 1.2 = 22.88 \text{ ft}$$

$$\text{Use } D = 23.0 \text{ ft}$$

Calculate Maximum Moment.

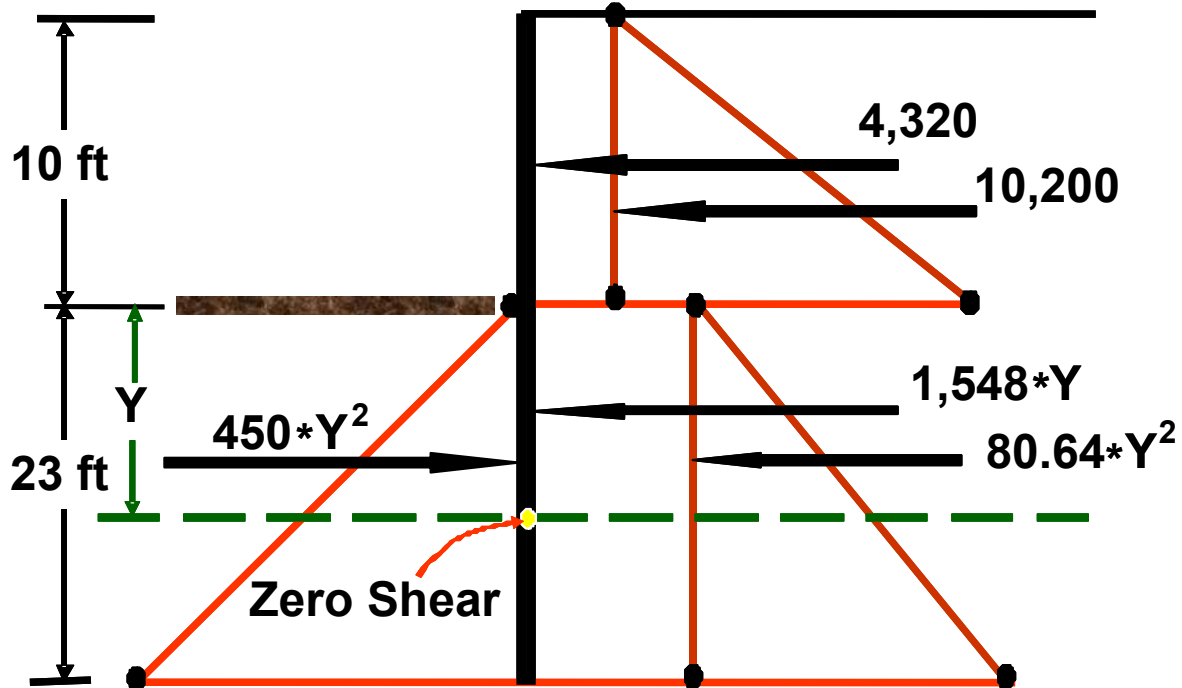

Figure 6-18. Location of Zero Shear and Maximum Moment

$$450Y^2 - 80.64Y^2 - 1548Y - 14,520 = 0.0$$

$$Y^2 - 4.19Y - 39.31 = 0.0$$

$$Y = 8.71 \text{ ft. Below the dredge line.}$$

CT TRENCHING AND SHORING MANUAL

$$M_{\max} = 4,320.00(5 + 8.71) + 10,200.00\left(\frac{10}{3} + 8.71\right) + 1,548.00(8.71)\left(\frac{8.71}{2}\right) + 80.64(8.71^2)\left(\frac{8.71}{3}\right) - 450.00(8.71^2)\left(\frac{8.71}{3}\right)$$

$$M_{\max} = 159,430 \text{ lb-ft} = 159.43 \text{ k-ft.}$$

$$F_b = 0.66F_y = 0.66(36) = 23.67 \text{ ksi}$$

$$S_{\text{required}} = \frac{M_{\max}}{F_b} = \frac{159.43 * 12}{23.67 \text{ ksi}} = 80.83 \text{ in}^3 < 106 \text{ in}^3 \therefore \text{ok}$$

6.4.3 Example 6-3 Deflection of a Cantilevered Soldier Pile Wall

The calculation to determine the deflected shape follows. It is noted that there is no specification that limits the deflection of a shoring system. See Table 8-1 for specific Railroad limitations on the deflection of shoring systems. It is essential that the Engineer exercise good engineering judgment when checking a shoring submittal for deflection.

The Engineer is also reminded that the method described below yields only approximate deflections. If the shoring system is adjacent to a Railroad or other high risk structure then a more rigorous approach may be necessary. See Section 6.3 DEFLECTION, Section 7.3.3 Deflection, and Section 8.3 DEFLECTION CALCULATION for more information.

To determine the deflected shape, it will be necessary to plot the shear and moment diagrams. Also, the unfactored Depth D_o needs to be based on the driving moment equaling the resisting moment: $M_{DR} = M_{RS}$. From above:

$$150D_o^3 - 26.88D_o^3 - 774D_o^2 - 14,520D_o - 55,600 = 0$$

$$123.12D_o^3 - 774D_o^2 - 14,520D_o - 55,600 = 0$$

$$D_o^3 - 6.29D_o^2 - 117.93D_o - 451.59 = 0$$

$$D_o \approx 15.66 \text{ ft}$$

Develop the loading diagram based on combined active and passive pressures below the excavation line:

Determine the slope of Line FCG:

$$S_{FCG} = (150D_o - 26.88D_o)(6') = 738.72D_o$$

Determine distance y to max shear below the excavation line:

$$y = 1548 / 738.72 = 2.1 \text{ ft}$$

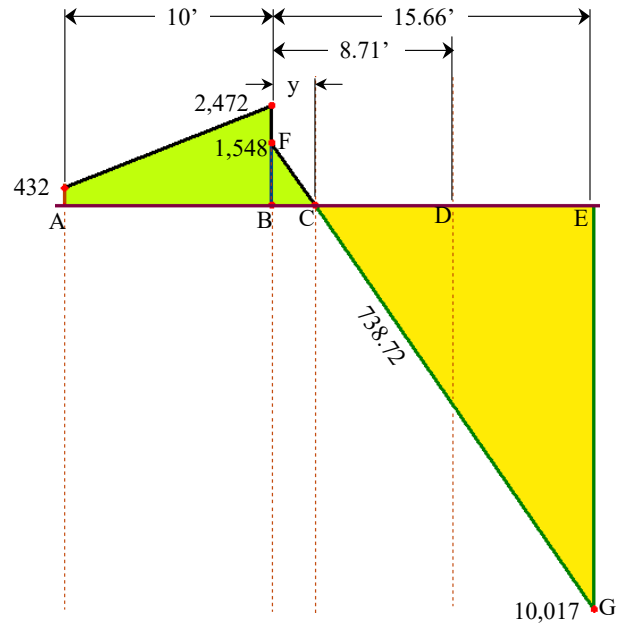

Figure 6-19. Loading Diagram

Determine the negative shears at:

Point B:

$$V_B = \frac{1}{2}(432 + 2472)(10') = 14,520 \text{ lbs}$$

Point C: (Max negative shear)

$$V_C = 14,520 + \frac{1}{2}(1548)(2.1') = 16,145 \text{ lbs}$$

Determine positive shear at Point E:

$$V_E = \frac{1}{2}(738.72)(8.71' - 2.1' + 15.66' - 2.1') (15.66' - 8.71') = 51,777 \text{ lbs}$$

Maximum shear in beam is at depth $D_o = 15.66 \text{ ft}$.

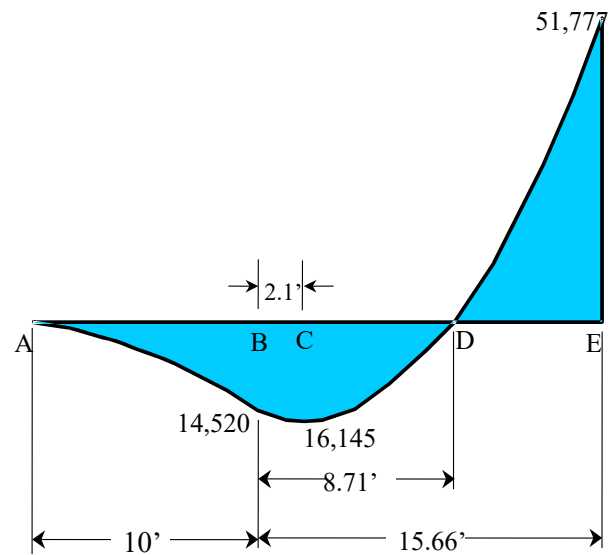

Figure 6-20. Shear Diagram

UNRESTRAINED SHORING SYSTEMS

Draw the moment Diagram

From the Loading Diagram:

Determine Moment at Point B:

$$M_B = \left[(432)(10')\left(\frac{10'}{2}\right) + \frac{1}{2}(2,472 - 432)(10')\left(\frac{10'}{3}\right) \right]$$

$$M_B = 55,600 \text{ lb-ft}$$

From the Shear diagram:

Determine Moment at Point C:

$$M_C = 55,600 + (14,520)(2.1') + \frac{2}{3}(16,145 - 14,520)(2.1') = 88,367 \text{ lb-ft}$$

Determine Moment at Point D:

$$M_D = 88,367 + \frac{2}{3}(16,145)(8.71' - 2.1') = 159,513 \text{ lb-ft}$$

NOTE: M_D is the maximum moment and it does differ slightly from that calculated above.

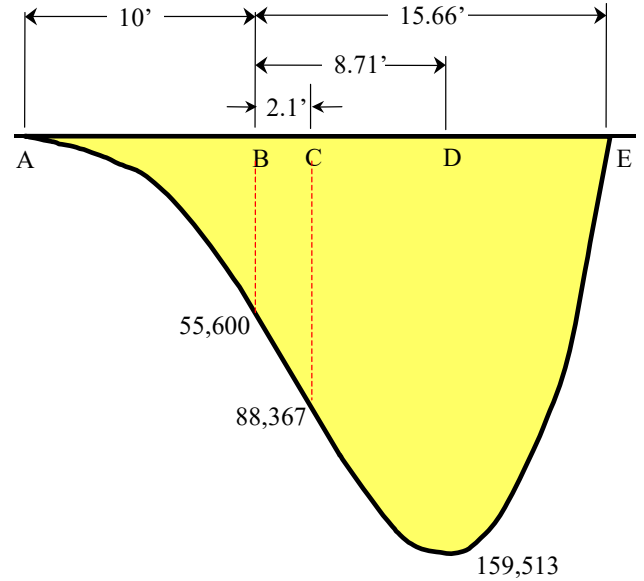

Figure 6-21. Moment Diagram

Determine the deflected shape of the beam:

Determine the depth to Point of Fixity (PoF)

below excavation line. (See Figure 8-11.)

$$\text{PoF} = (0.25)(D_o) = (0.25)(15.66') = 3.91'$$

Determine δ_C .

First, calculate Moment at B, 1.81' beyond

Max. Neg. Shear (i.e. 13.91' - 12.1'):

Determine Shear at B:

$$V_B = V_{12.1} - \frac{1}{2}(738.72)(1.81')(1.81')$$

$$V_B = 16,145 - 1,210 = 14,935 \text{ lbs}$$

Determine Moment at B:

$$M_B = 88,367 + (14,935)(1.81') + \frac{3}{4}(16,145 - 14,935)(1.81') = 116,892 \text{ ft-lbs}$$

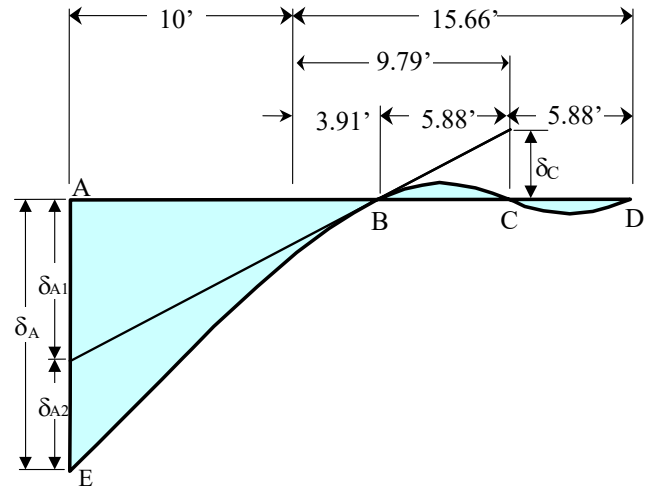

Figure 6-22. Deflected Shape

Next, in Figure 6-22, point C is assumed to act at half the distance between the PoF and the tip of the pile. This assumption appears to bring the ultimate results to a more realistic value.

Next, calculate Moment at C, 1.08 ft beyond maximum moment point (i.e. 19.79'-18.71'):

Determine Shear at C: (Ref. Figure 6-19 and Figure 6-20)

$$V_C = \left\{ \begin{array}{l} \frac{1}{2}(738.72) \\ \left[\left[(8.71' - 2.1') + (9.79' - 2.1') \right] (1.08') \right] \end{array} \right\}$$

$$V_C = 5,704 \text{ lbs}$$

Determine Moment at C: (Ref. Figure 6-21)

$$M_C = (159,513) - \frac{1}{3}(5,704)(1.08') = 157,459 \text{ ft - lbs}$$

Using the developed moment area diagram in Figure 6-23 Calculate δ_C due to moment area C to B: (i.e. Take moments about C.) (Ref. Figure 6-22)

$$\delta_C = \left[\begin{array}{l} (116,892)(4.8') \left(\frac{4.8'}{2} + 1.08' \right) + \frac{3}{4} (159,513 - 116,892)(4.8') \left(\frac{3}{7} 4.8' + 1.08' \right) + \\ (157,459) \left(\frac{1.08^2}{2} \right) + \frac{3}{4} (159,513 - 157,459)(1.08') \left(\frac{3}{5} \right) (1.08') \end{array} \right] \left(\frac{1728}{(650)(3E7)} \right)$$

$$\delta_C = (1,952,534 + 481,350 + 91,830 + 1,078) \left(\frac{1728}{(650)(3E7)} \right) = 0.224 \text{ in}$$

Note the Moment of Inertia of soldier beam HP12x84 is 650 in⁴.

Calculate δ_{A1} due to slope of tangent line at Point B. (See Figure 8-13.) (Ref. Figure 6-22)

$$\delta_{A1} = \delta_C \left(\frac{13.91'}{5.88'} \right) = (0.224) \left(\frac{13.91'}{5.88'} \right) = 0.530 \text{ in}$$

Calculate δ_{A2} due to moment area A to B: (e.g. Take moment about A.)

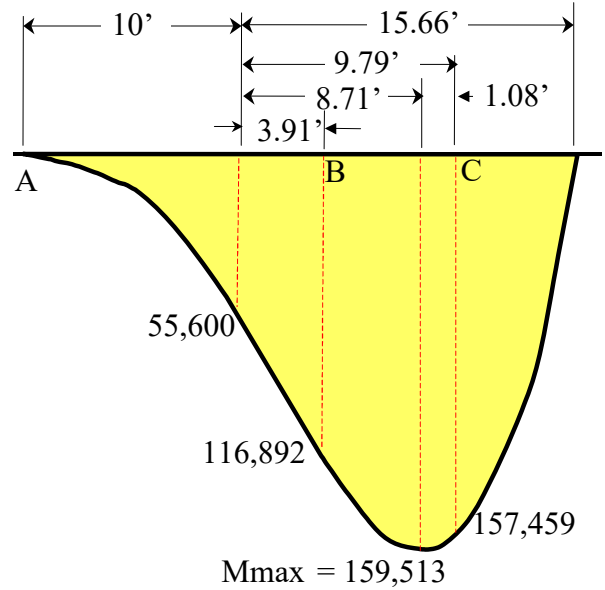

Figure 6-23. Moment Area diagram

UNRESTRAINED SHORING SYSTEMS

Note that for this calculation, the combined developed moment area diagram in Figure 6-23 will not be used. Instead separate moment area diagrams for the surcharge load and for the active and passive pressures will be created as shown in Figure 6-24. The latter method is used for additional accuracy because there is approximately an 11% error when using the combined developed moment area diagram as compared to separate moment area diagrams. Table 6-3 shows the calculations that use Figure 6-24.

CT TRENCHING AND SHORING MANUAL

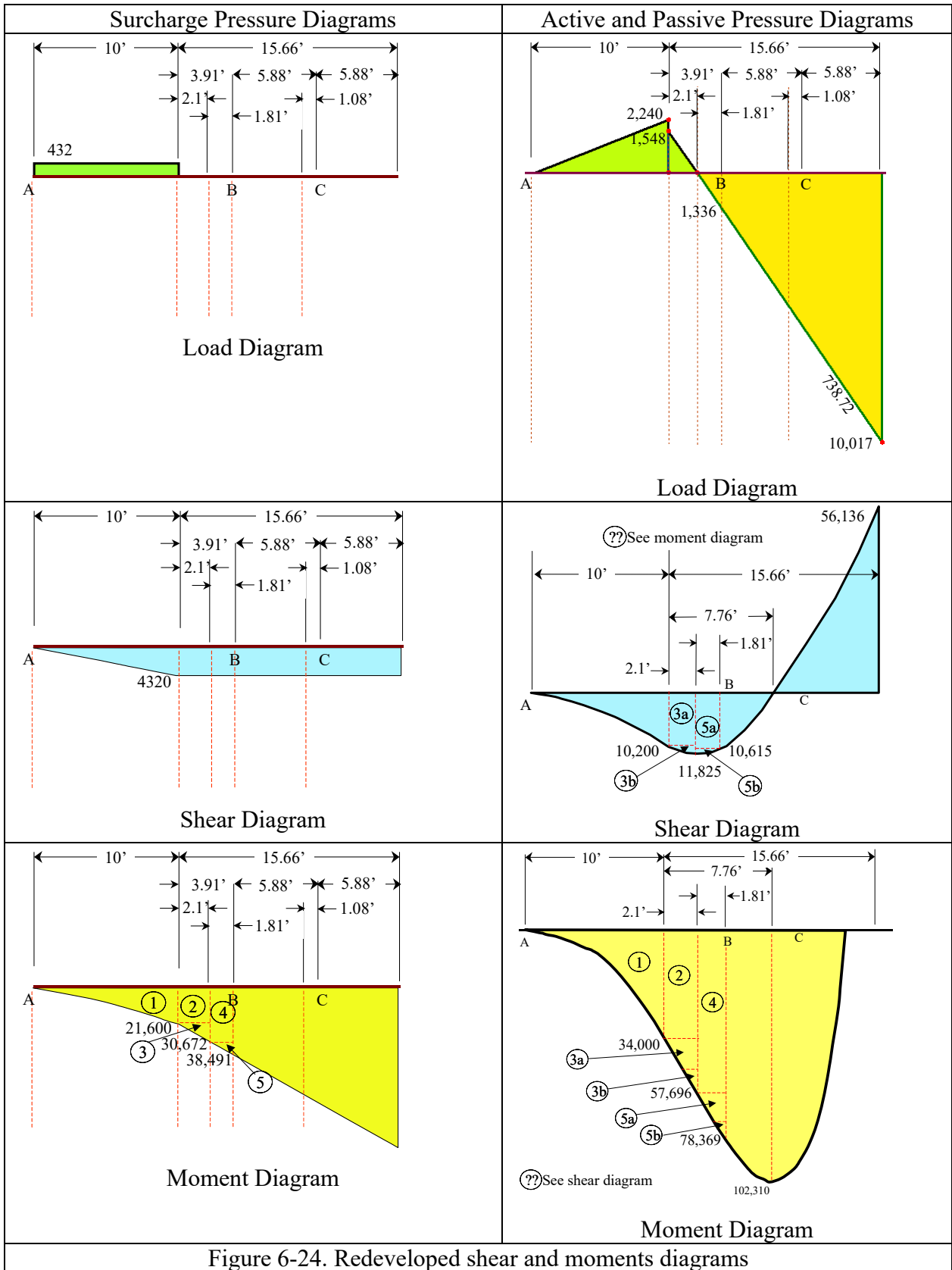

Figure 6-24. Redeveloped shear and moments diagrams

UNRESTRAINED SHORING SYSTEMS

For location 3a use triangular shape based on $10,200 * 2.1 = 21,420$.

For location 3b use 4th degree curve shape based on $\frac{2}{3}(1,625)(2.1) = 2,275$.

For location 5a use triangular shape based on $10,615 * 1.81 = 19,213$.

For location 5b use 4th degree curve shape based on $\frac{2}{3}(1,210)(1.81) = 1,460$.

Table 6-3. Calculations for deflection

Loc	Area	Moment Arm	Area Moment	Loc	Area	Moment Arm	Area Moment
①	$\frac{1}{3}(21,600)(10)$	$\frac{3}{4}(10)$	540,000	①	$\frac{1}{4}(34,000)(10)$	$\frac{4}{5}(10)$	680,000
②	$(21,600)(2.1)$	$10 + \left(\frac{2.1}{2}\right)$	501,228	②	$(34,000)(2.1)$	$10 + \left(\frac{2.1}{2}\right)$	788,970
③	$\frac{1}{2}(9,072)(2.1)$	$10 + \left(\frac{2}{3}\right)2.1$	108,592	③a	$\frac{1}{2}(21,420)(2.1)$	$10 + \left(\frac{2}{3}\right)2.1$	256,397
				③b	$\frac{1}{4}(2,275)(2.1)$	$10 + \left(\frac{5}{7}\right)2.1$	13,735
④	$(30,672)(1.81)$	$12.1 + \left(\frac{1.81}{2}\right)$	721,990	④	$(56,558)(1.81)$	$12.1 + \left(\frac{1.81}{2}\right)$	1,331,322
⑤	$\frac{1}{2}(7,819)(1.81)$	$12.1 + \left(\frac{2}{3}\right)1.81$	94,161	⑤a	$\frac{1}{2}(19,213)(1.81)$	$12.1 + \left(\frac{2}{3}\right)1.81$	231,373
				⑤b	$\frac{1}{4}(1,460)(1.81)$	$12.1 + \left(\frac{5}{7}\right)1.81$	8,848
Total			1,965,970	Total			3,310,645

The deflection δ_{A2} due to moment area from A to B is the summation of the totals above.

$$\delta_{A2} = (1,965,970 + 3,310,645) \left(\frac{1728}{(650)(3E7)} \right) = 0.467 \text{ in}$$

Total deflection at A:

$$\delta_A = \delta_{A1} + \delta_{A2} = 0.530 + 0.467 = 0.997 \text{ in}$$

The results above compare closely with the Caltrans Trenching and Shoring Check Program.

See Figure 6-28.

Results from Caltrans Trenching and Shoring Program (Custom Module)

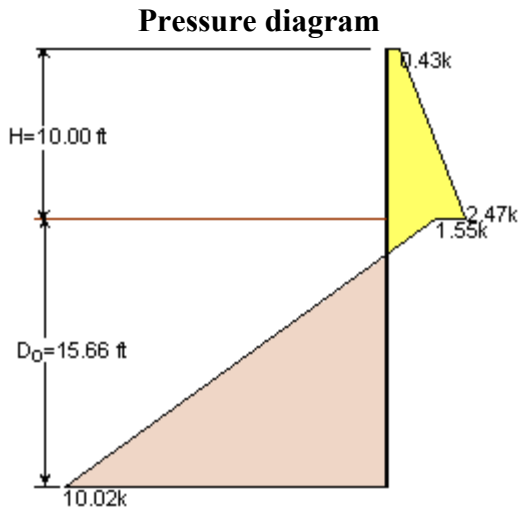

Figure 6-25. Loading Diagram

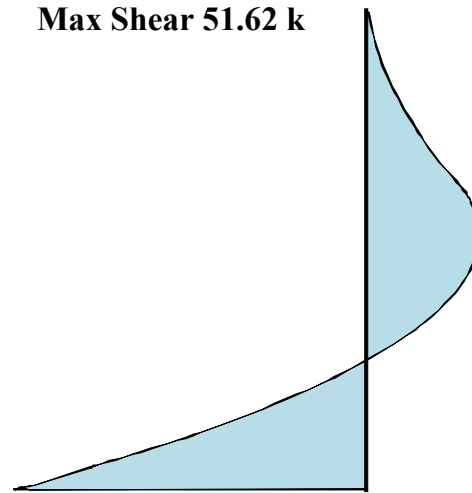

Figure 6-26. Shear Diagram

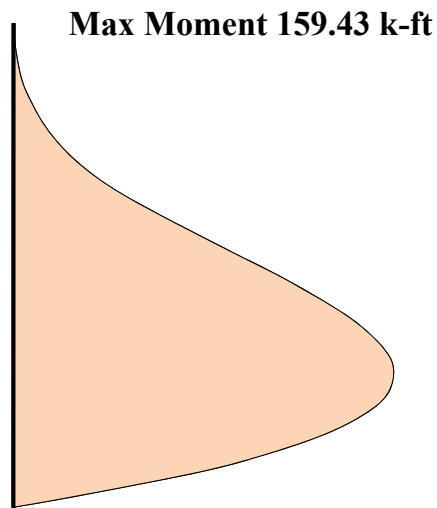

Figure 6-27. Moment Diagram

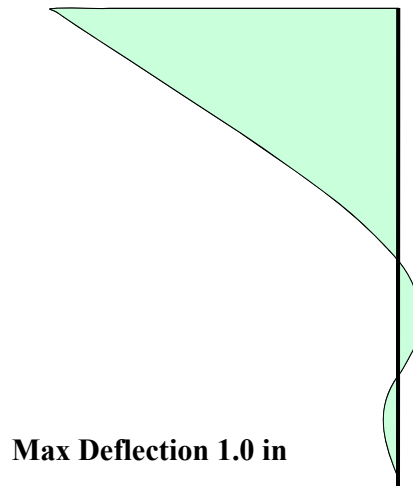
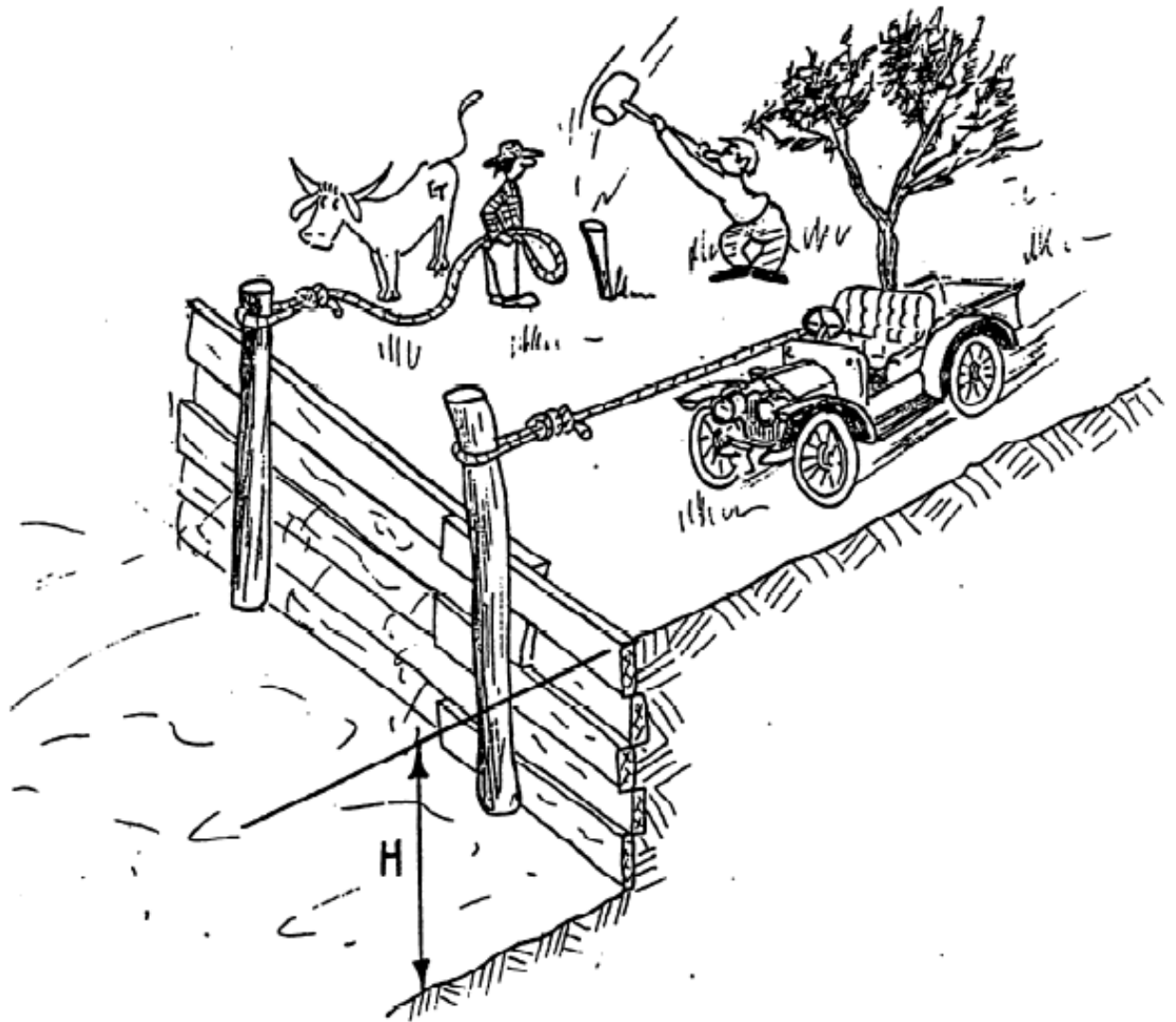

Figure 6-28. Deflection Diagram

CHAPTER 7

RESTRAINED SHORING SYSTEMS



7.0 LATERAL EARTH PRESSURES FOR RESTRAINED SHORING SYSTEMS

An anchored wall includes an exposed height (H) over which soil is retained. Also, an embedded depth (D) may provide vertical and lateral support in addition to either structural anchors or ground anchors, see Figure 7-1. In developing the lateral earth pressure for braced or anchored walls, consideration must be given to the wall displacement that may affect adjacent structures and/or underground utilities.

The lateral earth pressure acting on the wall is determined by the soil type and the appropriate earth pressure theory. Generally, the earth pressure increases with depth against a wall. But for braced or tieback walls this is not the case. A trapezoidal shaped apparent earth pressure distribution needs to be developed for this type of wall system.

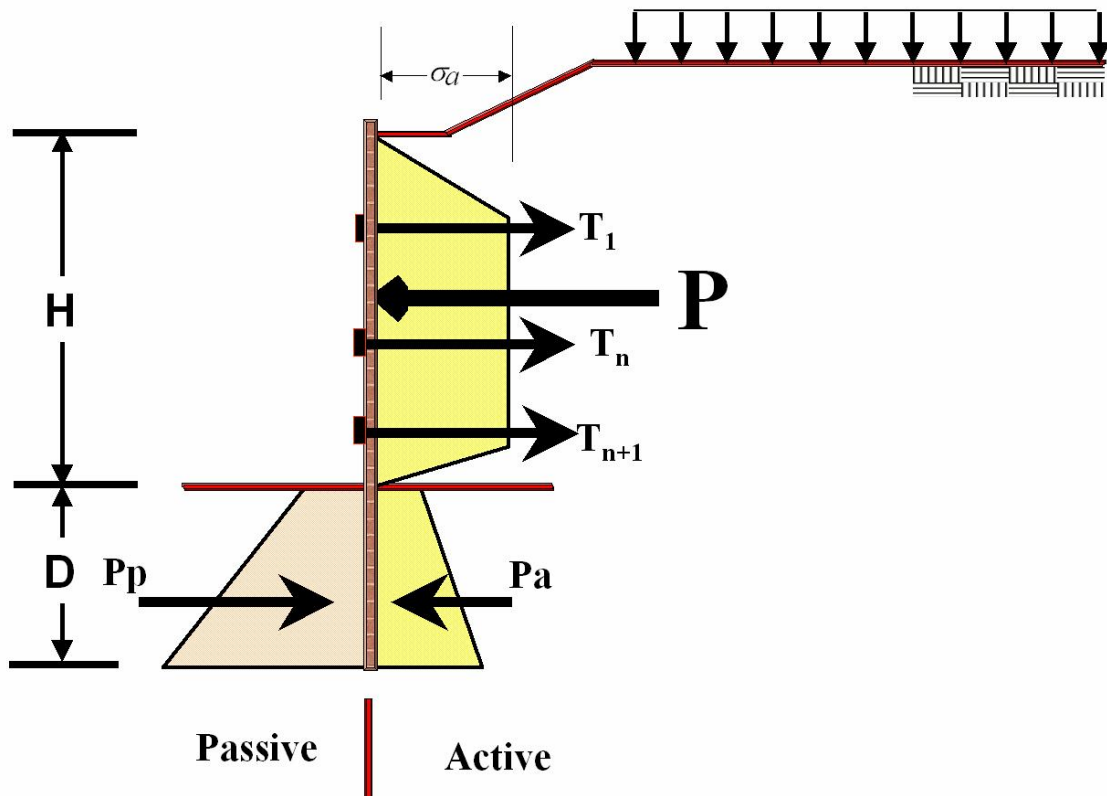

Figure 7-1. Lateral Earth Pressure for Anchored/Braced Walls

7.1 COHESIONLESS SOILS

The lateral earth pressure distribution for braced or anchored walls constructed in cohesionless soils may be determined using Figure 7-2 for single braced/tieback walls and Figure 7-3 for multiple braced/tieback walls.

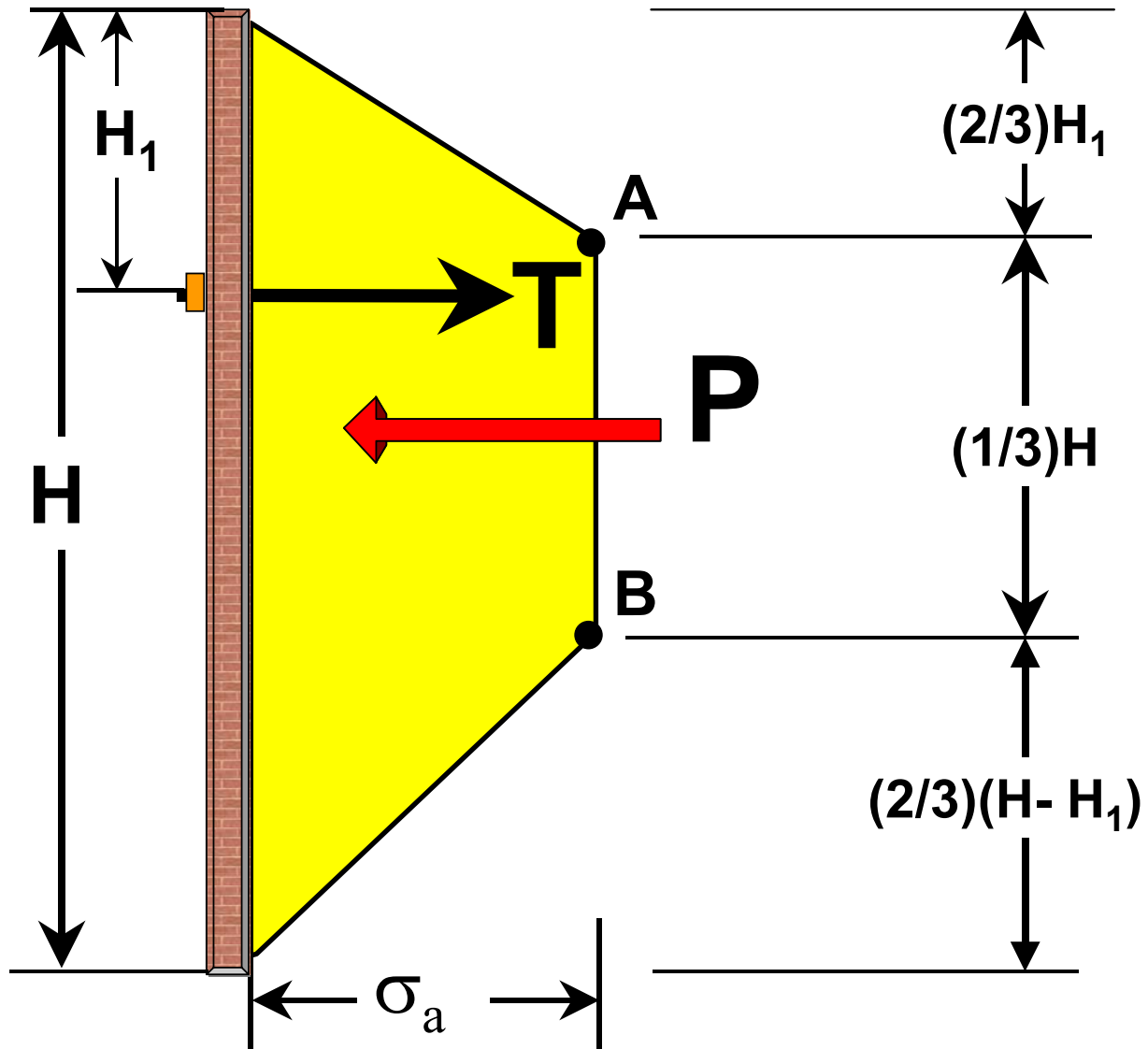

Figure 7-2. Pressure Diagram for Single Anchored/Braced Wall

RESTRAINED SHORING SYSTEMS

The maximum ordinate (σ_a) of the pressure diagram is determined as follows:

For walls with a single level of anchors or braces:

$$\sigma_a = \frac{f * P}{\left(\frac{2}{3}\right)H} = \frac{1.3 * P}{\left(\frac{2}{3}\right)H} \quad \text{Eq. 7-1}$$

Where the factor f is a constant to convert triangular pressure distribution to trapezoidal pressure distribution as is shown below.

Triangular pressure distribution:

$$P = \left(\frac{1}{2}\gamma\right)(h^2)(K_a)$$

Trapezoidal pressure distribution:

$$P_T = 0.65 \left[\gamma(h^2)(K_a) \right]$$

Let triangular pressure distribution equal to trapezoidal pressure distribution:

$$P_T = \left[\frac{1}{2}\gamma(h^2)(K_a) \right] f = 0.65 \left[\gamma(h^2)(K_a) \right] \Rightarrow f = \frac{0.65\gamma \left[(h^2)(K_a) \right]}{\left(\frac{1}{2}\gamma \right) \left[(h^2)(K_a) \right]} = 1.3$$

Therefore:

$$P_T = 1.3P \quad \text{Eq. 7-2}$$

The lateral active horizontal earth pressure for the multilevel anchors wall is shown in Figure 7-3:

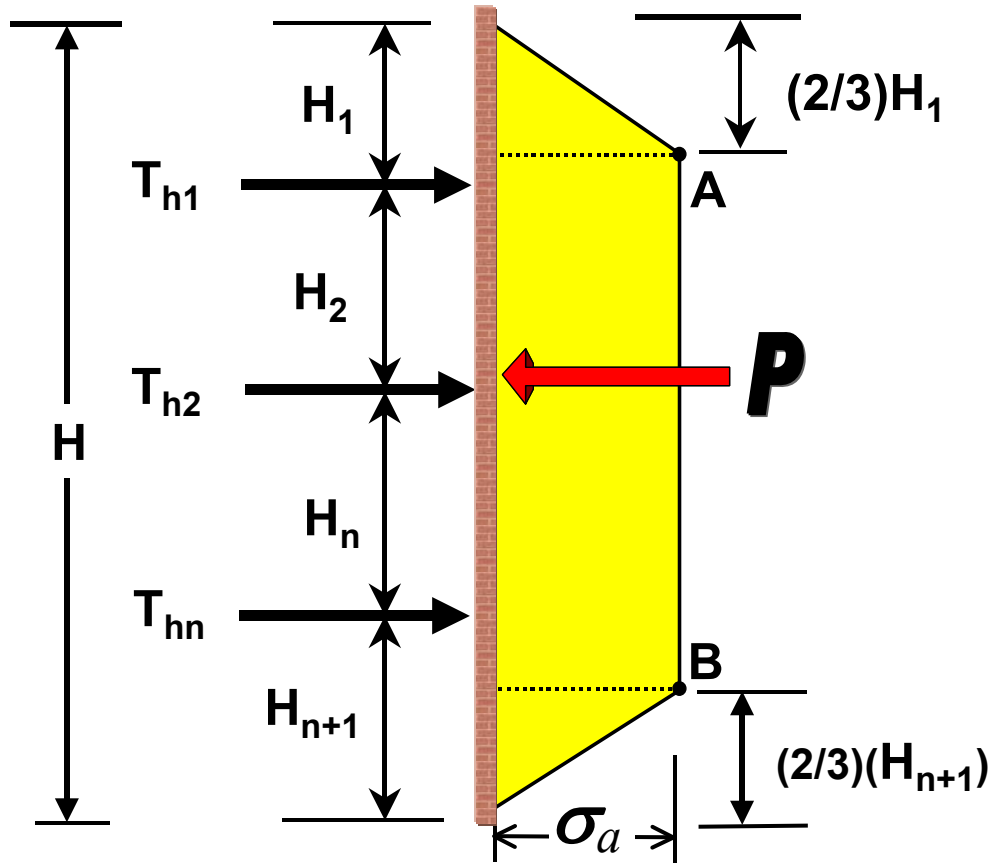

Figure 7-3. Pressure Diagram for Multi Anchored/Braced Wall

Eq. 7-3 may be used to calculate the active earth pressure for the multiple tieback wall.

$$\sigma_a = \frac{1.3P}{\left[H - \frac{1}{3}(H_1 + H_{n+1}) \right]}$$

Eq. 7-3

RESTRAINED SHORING SYSTEMS

Where:

σ_a = maximum ordinate of pressure diagram.

P = total lateral load required to be applied to the wall.

H = wall height.

H_1 = distance from ground surface at top of wall to uppermost level of anchors.

H_{n+1} = distance from the grade at bottom of a wall to lowermost level of anchors.

n = number of anchors.

T_{hn} = horizontal component of the anchor force at level n .

P_a = active lateral earth pressure below dredge line.

P_p = passive lateral earth pressure below dredge line.

7.2 COHESIVE SOILS

The lateral earth pressure distribution for cohesive soils is related to the stability number (N_s), which is defined as:

$$N_s = \frac{\gamma_s(H)}{C} \quad \text{Eq. 7-4}$$

Where:

γ_s = total unit weight of soil.

H = wall height.

C = average undrained shear strength of soil.

7.2.1 Stiff to Hard

For braced or anchored walls in stiff to hard cohesive soils with the stability number (N_s) less than or equal to 4 the lateral earth pressure may be determined using Figure 7-4, with the maximum ordinate (σ_a) of the pressure diagram determined as:

$$\sigma_a = 0.2(\gamma_s)(H) \quad \text{to} \quad 0.4(\gamma_s)(H) \quad \text{Eq. 7-5}$$

Where:

σ_a = maximum ordinate of trapezoidal pressure diagram.

γ_s = total unit weight of soil.

H = wall height.

7.2.2 Soft to Medium Stiff

The lateral earth pressure on a restrained shoring system in soft to medium stiff cohesive soils with the stability number equal to or larger than 6 may be determined, using Figure 7-4 for which the maximum ordinate (σ_a) of the pressure diagram is determined as:

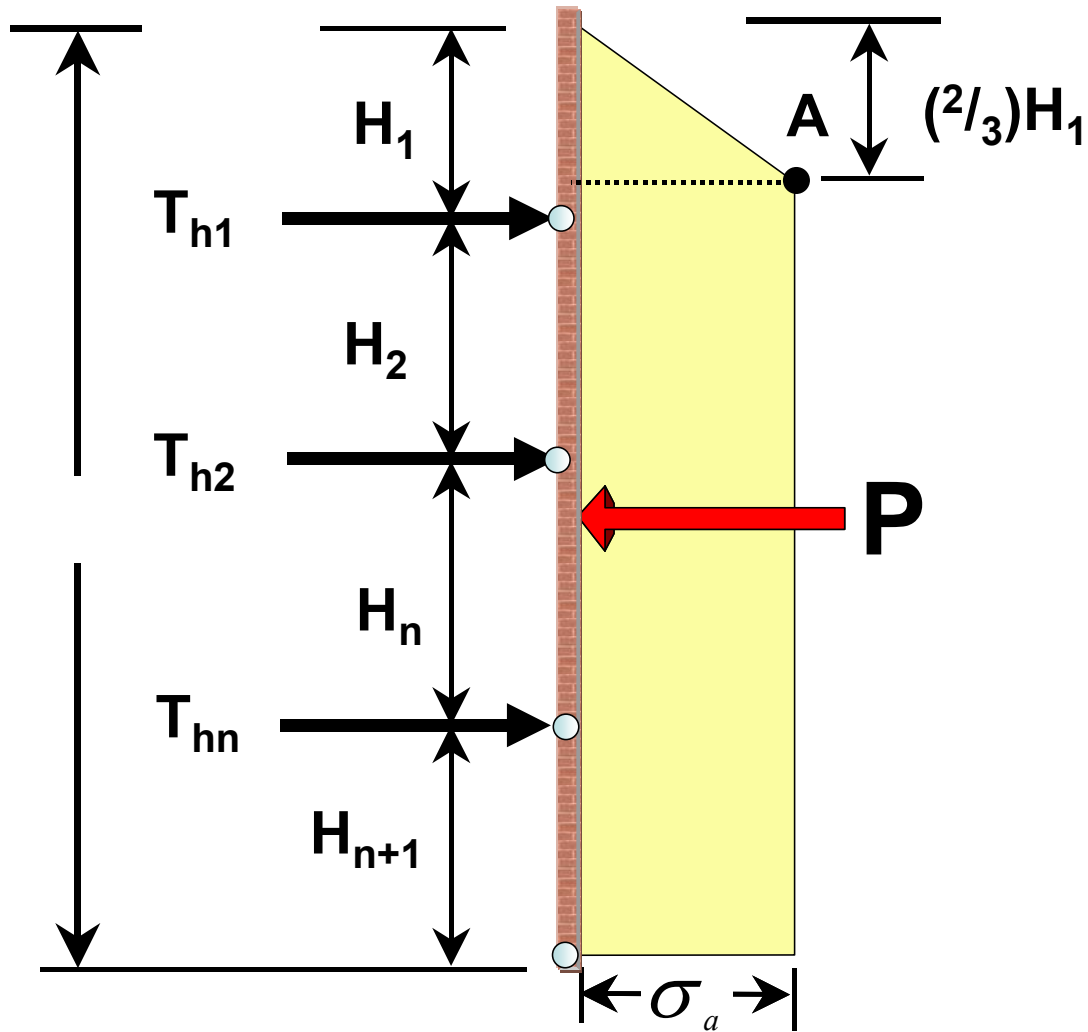

Figure 7-4. Pressure Diagram for Multi Anchored/Braced Wall for Cohesive Backfill

$$\sigma_a = (K_a)(\gamma_s)(H)$$

Eq. 7-6

RESTRAINED SHORING SYSTEMS

Where:

σ_a = maximum ordinate of pressure diagram.

K_a = coefficient of active lateral earth pressure.

γ_s = total unit weight of soil.

H = wall height.

The coefficient of active lateral earth pressure (K_a) may be determined using Eq. 7-7.

$$K_a = 1 - \frac{4(C1)}{(\gamma_s)(H)} + 2\sqrt{2} + \frac{D}{H} \left[\frac{1 - 5.14(C2)}{(\gamma_s)(H)} \right] \geq 0.22 \quad \text{Eq. 7-7}$$

Where:

C1 = undrained shear strength of retained soil.

C2 = undrained shear strength of soil below grade in front of wall.

γ_s = total unit weight of retained soil.

H = wall height.

D = depth from the grade in front of the wall to the potential failure surface below.

For soils with $4 < N_s < 6$, use the larger σ_a from Eq. 7-5 and Eq. 7-6.

7.3 CALCULATION PROCEDURES

7.3.1 Single Tieback/Brace System

The following procedure is used for the analysis of a Single Tieback/Brace System wall including any surcharge as shown in Figure 7-5:

1. Determine the Earth Pressure Coefficients using the classical Earth Pressure Theories described in the previous section.
2. Convert the active earth pressure above the excavation line to a trapezoidal earth pressure.
3. Take moments about the tieback to calculate embedment depth D , using a factor of safety of 1.3.
4. Take moments about the tieback to calculate embedment depth D , using a factor of safety of 1.0 to calculate tieback load T in following step 5.
5. Set summation of forces equal to zero in horizontal direction to calculate tieback/brace force T .
6. Calculate Maximum Bending Moment (M_{MAX}) and Maximum Shear Force (V_{MAX}) to analyze the vertical structural member and lagging.

RESTRAINED SHORING SYSTEMS

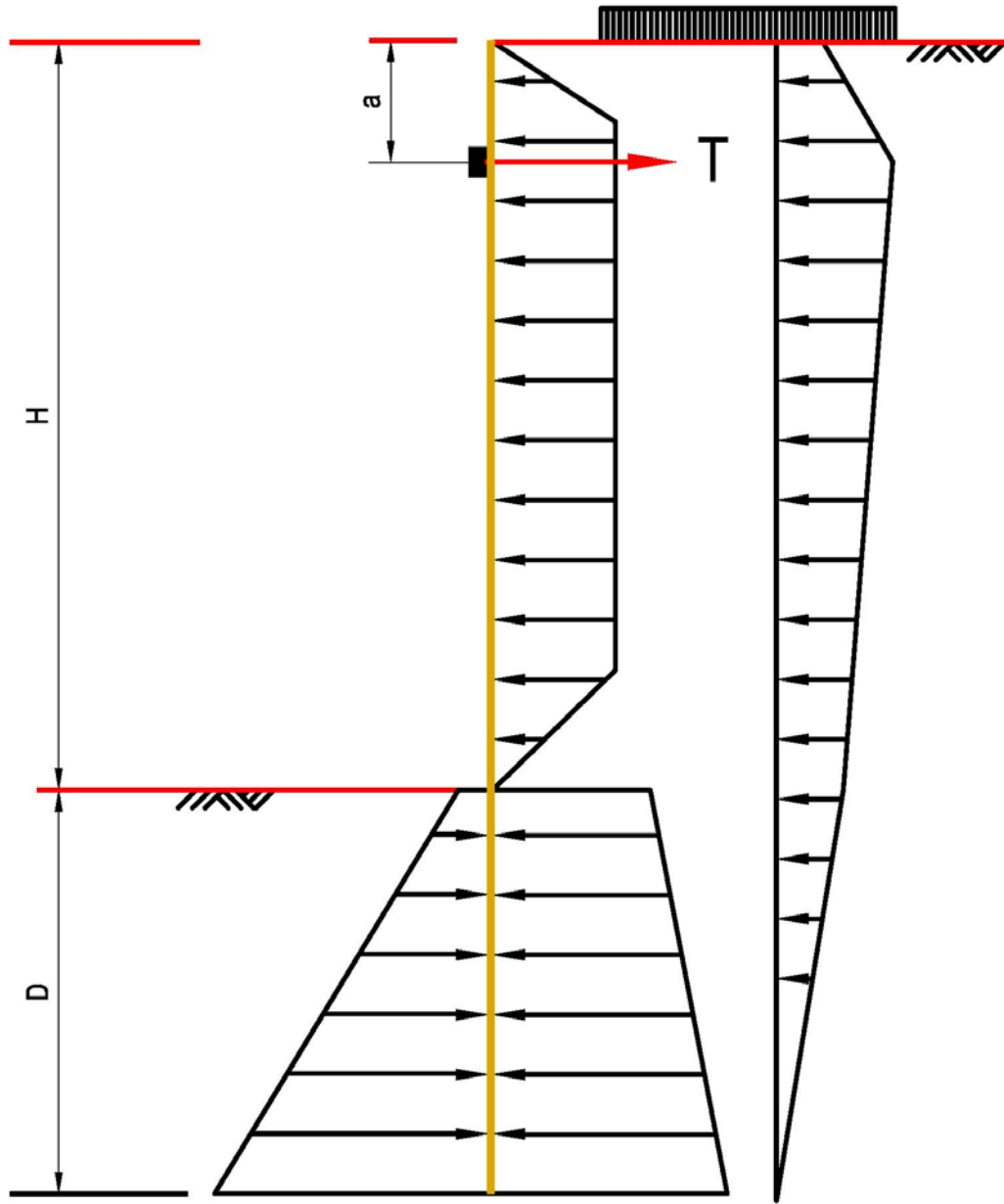

Figure 7-5. Single Tieback System

7.3.2 Multiple Tieback/Brace System

Depending on the backfill properties trapezoidal soil's pressure diagram shown in Figure 7-3 and Figure 7-4 are used for the analysis of multiple tieback systems. Figure 7-6 shows a simple trapezoidal pressure diagram for a multiple tieback system. The beam is divided into three types of spans.

- Starting Cantilever Span S_1 .
- Interior Spans S_n .
- Embedment Span S_D .

Per the FHWA the two methods used to calculate the embedment depth, D , and tieback load, T , are the Hinge Method and the Tributary Area Method. The Tributary Area Method balances only summation of forces, which results in a large moment at the tip of the pile. The Hinge Method satisfies the force and moment equilibrium in that the shear and moment equal zero at the tip of the pile. Both finite element and beam spring models show the same trend.

The detailed procedure is shown below:

RESTRAINED SHORING SYSTEMS

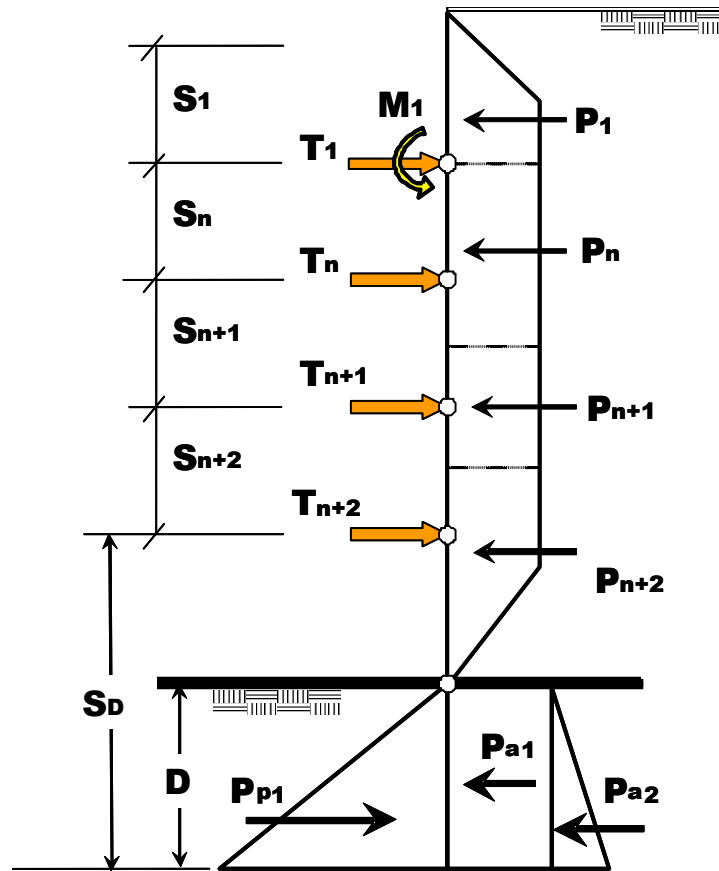

Figure 7-6. Multiple Tieback System

The Hinge Method as shown in Figure 7-6 and Figure 7-7 is used to solve multiple Tieback/Brace systems.

- Take moments M_1 about the upper level tieback due to cantilever action of the soil pressure above the upper tieback. The moments at the remaining tiebacks are assumed to be zero (0).
- Use combination of the moment M_1 and tributary area to calculate the remaining tieback loads except the last tieback load.
- Calculate last tieback load T_{n+2} .
 - Calculate embedment depth D by taking moments about the last tieback. (Set Driving Moment = Resisting Moment.)
 - Set summation of forces equal to zero in horizontal direction to calculate the last tieback load T_{n+2} .
- Take moments about the last tieback to calculate embedment depth D using a factor of safety of 1.3 for external stability.

7.3.3 Deflection

A general discussion of deflection for unrestrained temporary shoring systems was described in the previous chapter. The same approach applies when calculating the deflection of restrained shoring systems. For simple beam analysis, the deflection at the supports along the vertical element of the shoring system is assumed to be zero (0) as shown in Figure 7-8. The Point of Fixity varies from 0.25D to 0.8D below the excavation level and is a function of the effective pile diameter and soil type.

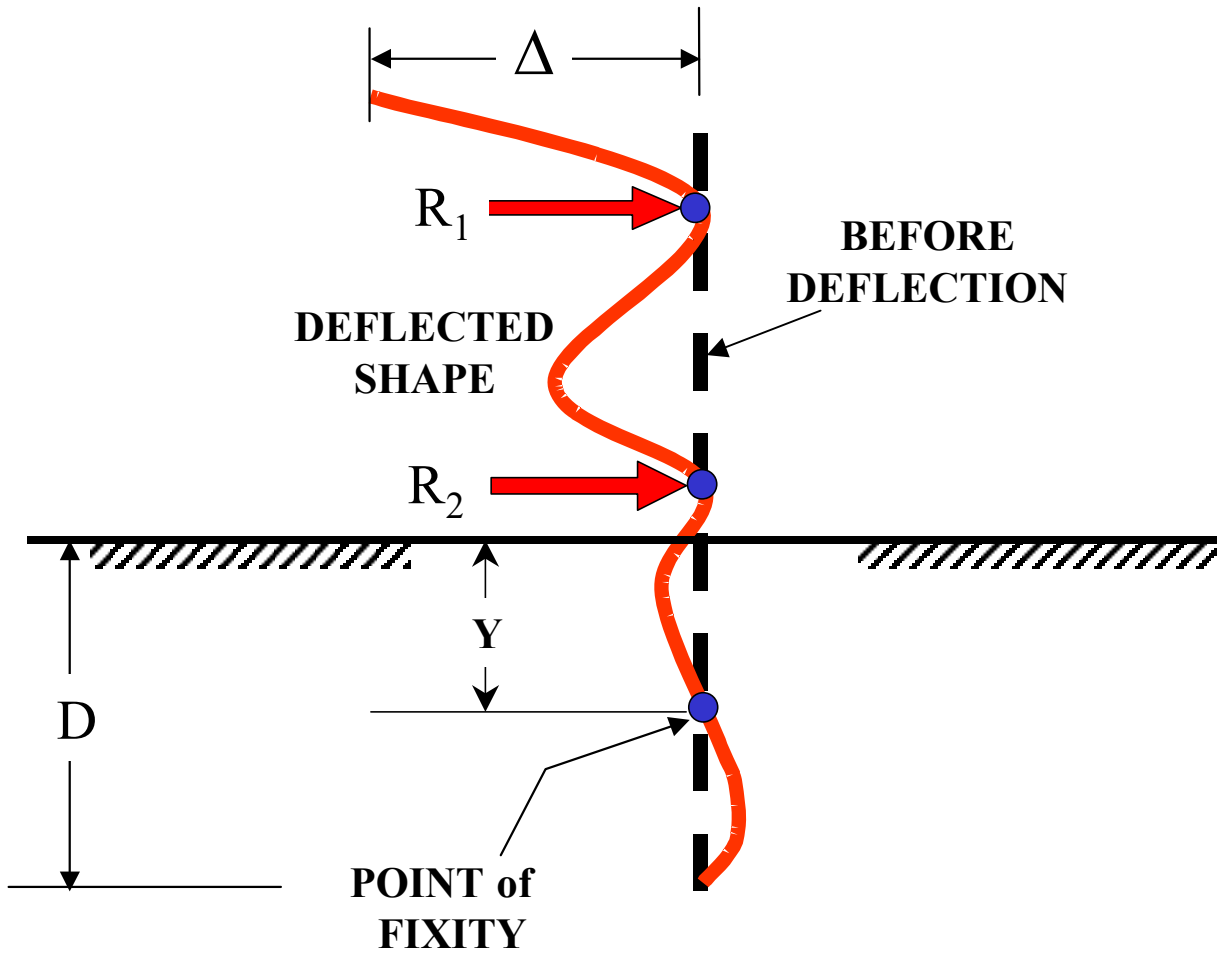

Figure 7-8. Deflected Shape for Restrained System

7.3.4 Example 7-1 Single Tieback Sheet Pile Wall

Check the adequacy of a single tieback sheet pile wall with a single soil layer shown below with a tieback spacing = 10 feet. The sheet pile section is a PZ22, steel grade 42 ksi.

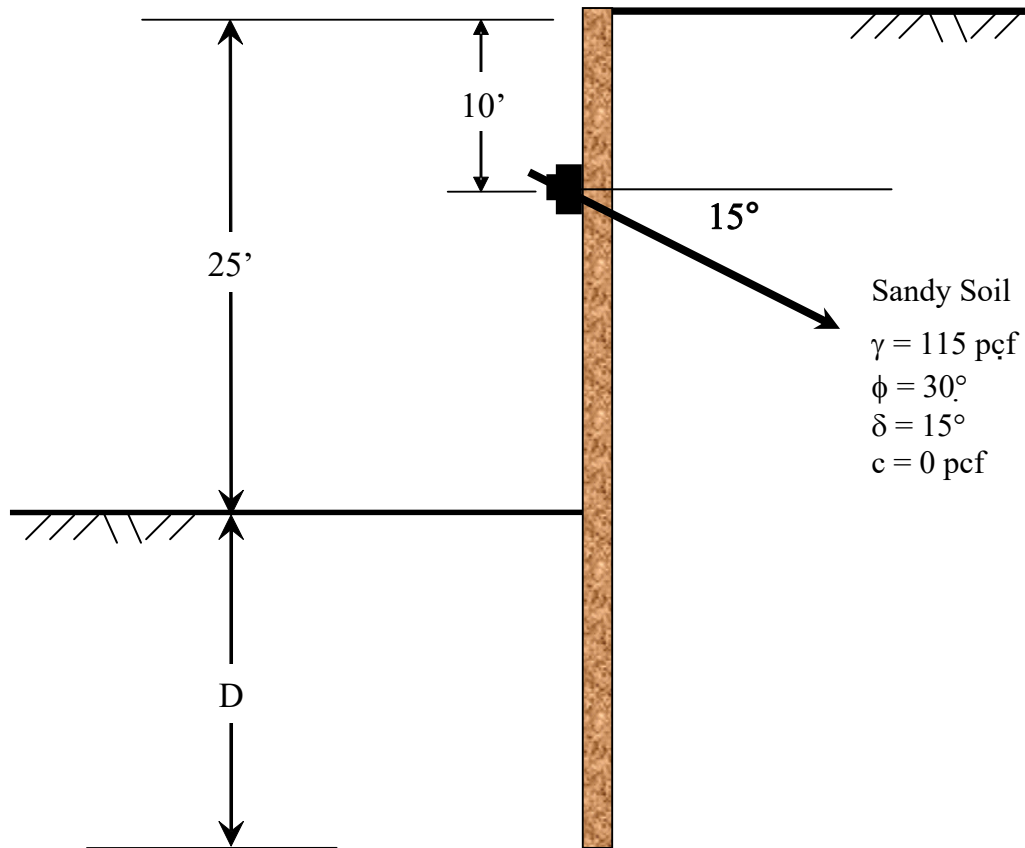

Figure 7-9. Example 7-1

Determine:

1. Active & Passive Earth Pressures.
2. Pile Embedment D with $FS = 1.3$.
3. Tieback Load with $FS = 1.0$.
4. Maximum Shear, Maximum Moment.

RESTRAINED SHORING SYSTEMS

Structural properties of sheet pile section PZ22 are:

- Section Modulus per foot of wall width: $S = 18.10 \text{ in}^3$.
- Moment of Inertia per foot of wall width: $I = 84.70 \text{ in}^4$.
- Radius of Gyration per foot of wall width: $r = 3.62 \text{ in}$.
- Area per foot of wall width: $A = \frac{I}{r^2} = \frac{84.7 \text{ in}^4}{(3.62 \text{ in})^2} = 6.46 \text{ in}^2$

Develop the pressure diagram:

From Rankine's Theory: $K_a = \frac{1}{3}$. Using the Log Spiral Theory, from Figure 4-37: $K_p = 4.7$.

Also, since the wall friction angle (δ) is 0:

$$K_{ph} = K_p = 4.7.$$

The lateral earth pressure distribution for the analysis of anchored walls constructed in cohesionless soils may be determined using Figure 7-10.

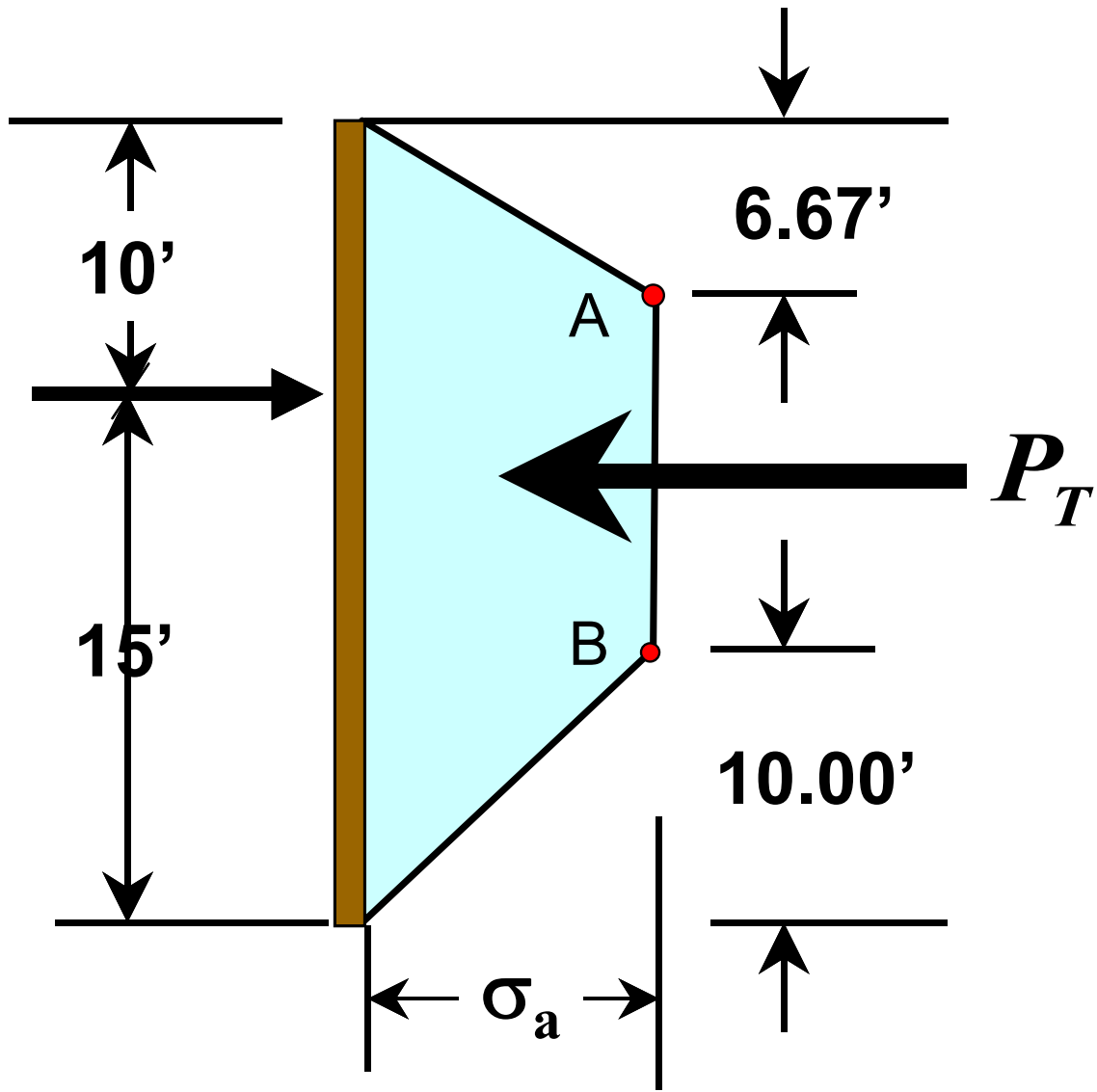

Figure 7-10. Pressure Diagram for Single Tieback Wall

The maximum ordinate (σ_a) of the pressure diagram is determined as follows:

$$\sigma_a = \frac{1.3P}{\left(\frac{2}{3}\right)h} = \frac{P_T}{\left(\frac{2}{3}\right)h}$$

Where the total active earth pressure for a triangular pressure distribution is calculated as follows:

$$P = \frac{1}{2} \gamma h^2 K_a$$

RESTRAINED SHORING SYSTEMS

Using Eq. 7-2: $P_T = 1.3 * P$

$$P = \left(\frac{1}{2}\right)(115)(25^2)\left(\frac{1}{3}\right) = 11,980 \text{ lb}$$

$$P_T = 1.3P = 1.3 * 11,980 = 15,574 \text{ lb}$$

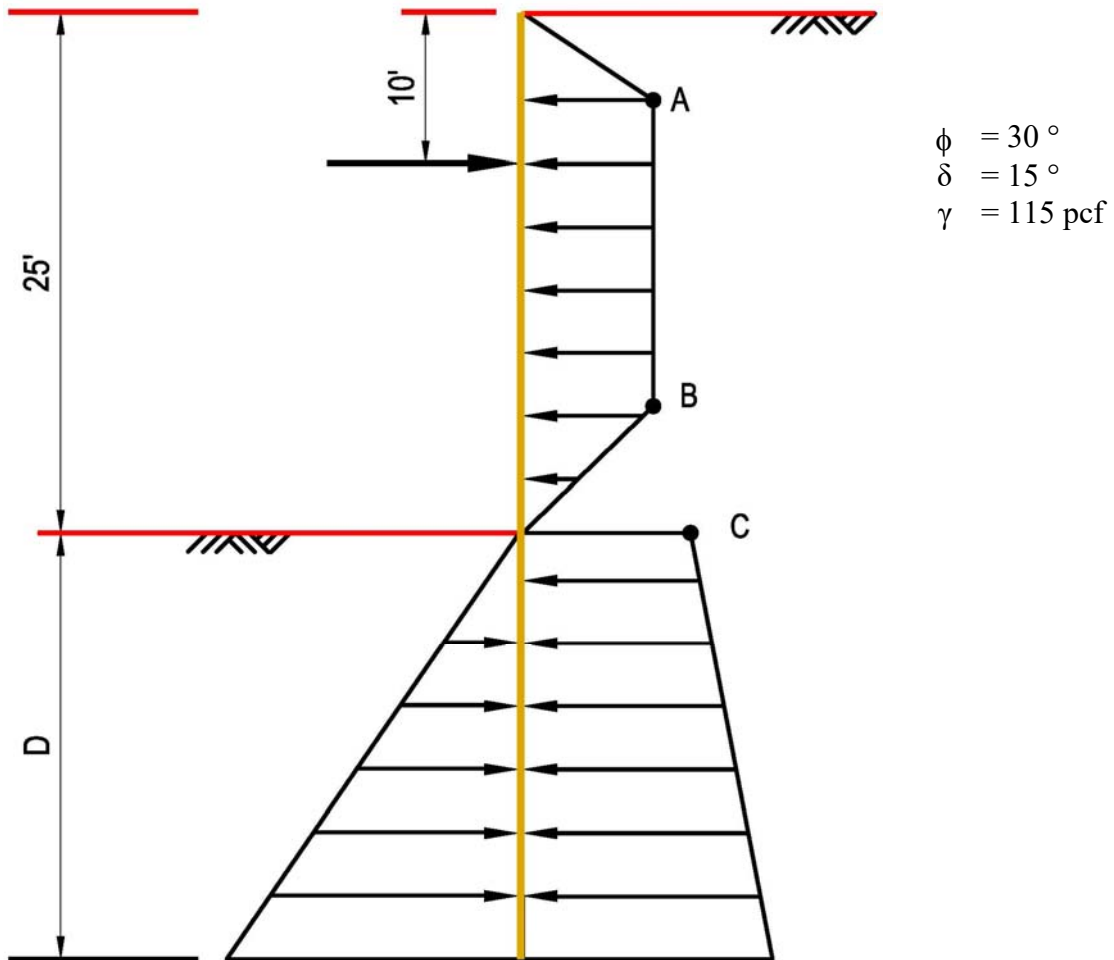

Figure 7-11. Pressure Diagram

Active stress at the point A and B as shown in Figure 7-11:

$$\sigma_a = \frac{15,574}{\left(\frac{2}{3}\right)25'} = 934.4 \text{ psf}$$

Active stress at the dredge line point C:

$$\sigma_c = (115)(25')\left(\frac{1}{3}\right) = 958.3 \text{ psf}$$

$$FS = \frac{M_R}{M_D}$$

Let FS=1.3.

$$M_R = 1.3M_D$$

Take moment about the tieback

$$M_D = \left[\begin{aligned} & (934.4) \left(\frac{6.67'}{2} \right) \left(3.33' + \frac{6.67'}{3} \right) - (934.4)(8.33')(0.835') \\ & - (934.4) \left(\frac{10'}{2} \right) (8.33') - (958.3) \left(15' + \frac{D}{2} \right) D \\ & - (0.5)(115) \left(\frac{1}{3} \right) \left(15' + \frac{2}{3} D \right) D^2 \end{aligned} \right]$$

As determined above: K_{ph} is 4.7.

$$M_R = \frac{1}{2} (115)(4.7) \left(15' + \frac{2}{3} D \right) D^2$$

Solve for D.

$$D^3 + 18.7D^2 - 114.53D - 223.98 = 0$$

$$D \approx 6.09 \text{ ft}$$

Solve for tieback force T by setting the resisting moment equal to driving moment as shown below:

$$M_R = M_D$$

Find D' :

$$D'^3 + 19.64D'^2 - 85.88D' - 167.95 = 0$$

$$D' \approx 4.89 \text{ ft}$$

$$\sum F_X = 0$$

$$\left[\begin{aligned} & - \left(\frac{25 + 8.33}{2} \right) (934.4) - \frac{1}{2} (115)(4.89^2) \frac{1}{3} - (958.3)(4.89) + \\ & \frac{1}{2} (115)(4.89^2)(4.7) \end{aligned} \right] (10) + T_H = 0$$

$$T_H = 142.54 \text{ kips} \quad \text{and} \quad T = \frac{142.54}{\cos(15^\circ)} = 147.57 \text{ kips}$$

RESTRAINED SHORING SYSTEMS

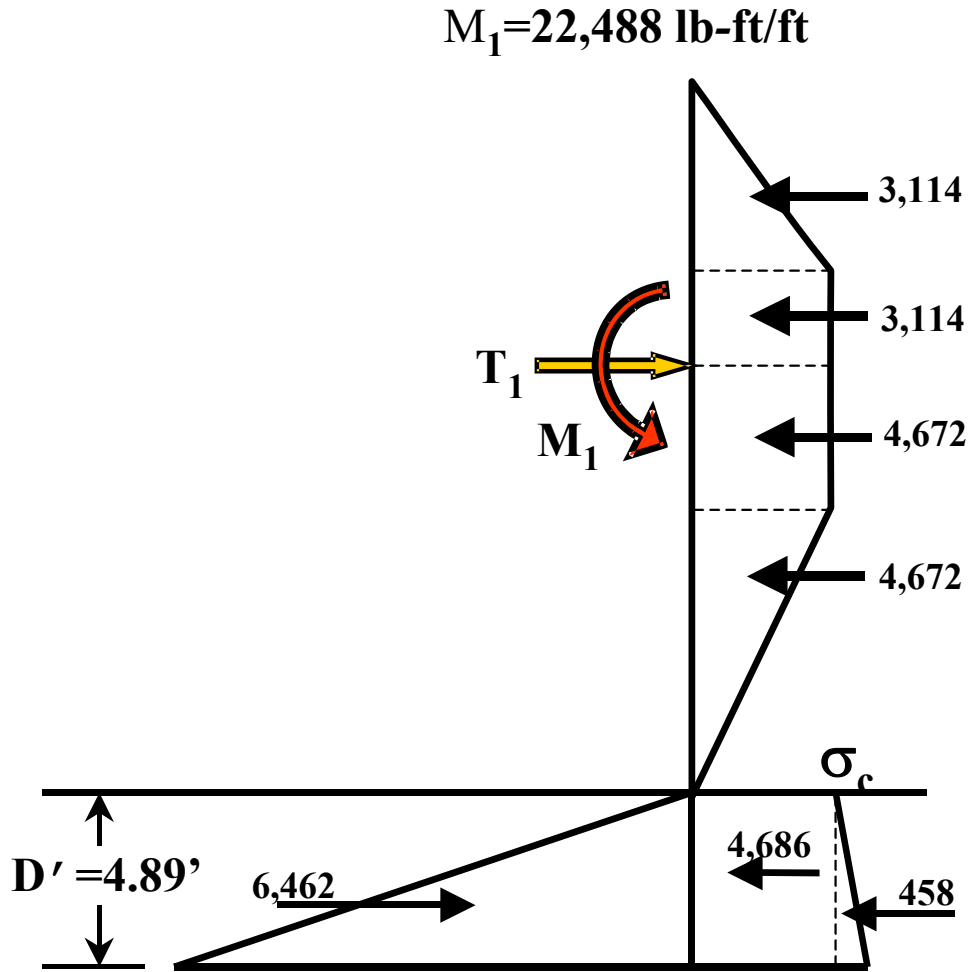

Figure 7-12. Pressure Diagram For Single-Tieback Above Dredge Line
Based on $M_R = M_D$.

The maximum shear in the beam is located at the Tieback.

$$T_{1U} = \frac{1}{2}(934.4)(6.667') + (934.4)(3.333') = 3,114 + 3,114 = 6,228 \text{ lbs}$$

$$T_{1L} = \frac{1}{2}(934.4)(10') + (934.4)(5') + (958.3)(4.89') + \frac{1}{2}(115)\left(\frac{1}{3} - 4.7\right)(4.89')^2 = 4,672 + 4,672 + 4,686 - 6,004 = 8,026 \text{ lbs}$$

Maximum shear is $T_{1L} = 8,026 \text{ lbs}$.

$$f_v = \frac{8,026 \text{ lbs}}{6.46 \text{ in}^2} = 1,242 \text{ psi} < 16,800 \text{ psi}$$

$F_v = 42,000 \text{ psi} * 0.4 \approx 17,000 \text{ psi} \therefore \text{PZ22 is satisfactory in shear.}$

CT TRENCHING AND SHORING MANUAL

Determine moment M_1 at top tieback due to cantilever loads:

$$M_1 = F_1 * \text{Mom arm of triangular load} + F_2 * \text{Mom arm of rectangular load}$$

$$\begin{aligned} M_1 &= \frac{1}{2}(934.4)(6.667)\left(3.333 + \frac{6.667}{3}\right) + (934.4)(3.333)\left(\frac{3.333}{2}\right) \\ &= (3,114)(5.555) + (3,114)(1.667) = 17,299 + 5,189 = 22,488 \text{ lb-ft} \end{aligned}$$

Determine moment at zero shear below tieback. Please refer to Figure 7-15 for shear diagram of single tieback. The point of zero shear is either located below the bottom of excavation or it is located between the tieback and the bottom of excavation. For this particular example problem, when the summation of forces in the horizontal direction includes the area below the bottom of excavation, a quadratic equation results with two possible roots. As shown below, one root lies at depth D but is not the root we are looking for. The other root is negative and therefore, cannot be used:

$$\begin{aligned} \sum F_H &= 8026 - 4672 - 4672 - 958.3y' - \frac{1}{2}(115)\left(\frac{1}{3} - 4.7\right)(y')^2 \\ &= -1318 - 958.3y' + 251.09y'^2 = 0 \end{aligned}$$

Solving:

$$y'^2 - 3.816y' - 5.25 = 0 \text{ yields: } y' = 4.89 \text{ ft and } y' = -1.07 \text{ ft}$$

Since the second root is invalid, the point of zero shear must be located above the bottom of excavation. Further, it can be surmised that the point of zero shear is located within the sloping portion of the load diagram below the tieback since:

$$T_{1L} - (934.4)(5') = 8,026 \text{ lbs} - 4,672 \text{ lbs} = 3,354 \text{ lbs} > 0$$

RESTRAINED SHORING SYSTEMS

The slope of the load line just above the dredge line is

$$934.4/10' = 93.44. \text{ Solving for } y':$$

$$(8,026 - 4,672) = \frac{1}{2}(934.4 + 934.4 - 93.44y')y' =$$

$$(2)(3,354) = 1,868.8y' - 93.44y'^2$$

$$\therefore 93.44y'^2 - 1,868.8y' + 6,708 = 0$$

$$y' = 4.69'$$

The point of zero shear is located $5' + 4.69' = 9.69'$ below

T_1 . Taking moments about the point of zero shear (O)

in Figure 7-13:

$$F_1 = \frac{1}{2}(93.44)(4.69')(4.69') = 1,027.6 \text{ lbs/ft}$$

$$F_2 = (93.44)(10' - 4.69')(4.69') = 2,326.7 \text{ lbs/ft}$$

$$M_{1-tip} = \left[\begin{array}{l} (8,026)(9.69') - (4,672)\left(\frac{5'}{2} + 4.69'\right) - \frac{2}{3}(1,027)(4.69') - \frac{1}{2}(2,326)(4.69') \\ - 22,488 \end{array} \right]$$

$$M_{1-tip} = 77,772 - 33,592 - 3,211 - 5,455 - 22,488 = 13,026 \text{ ft} \cdot \text{lbs/ft}$$

Therefore the maximum moment is at T_1 : $M_1 = 22,488 \text{ ft} \cdot \text{lbs/ft}$.

Check the bending stress in the sheet pile section:

$$f_b = \frac{22,488 \text{ ft} \cdot \text{lb} \cdot 12 \text{ in/ft}}{18.10 \text{ in}^3} = 14,909 \text{ psi}$$

$$F_b = 42,000 \text{ psi} \cdot 0.6 \approx 25,000 \text{ psi} \therefore \text{ Therefore, PZ22 is satisfactory in bending.}$$

The process to check deflection can be found in Example 6-2 and EXAMPLE 8-1 and will

not be calculated for this example. Figure 7-17 represents the deflected shape of the PZ22

sheet pile based on the Moment Area method; therefore, use these values with caution.

The deflection due to the cantilever is 0.20 inches. The maximum deflection is 0.23 inches

and is located about 9.6 ft below T_1 . The respective diagrams are shown in Figure 7-14

through Figure 7-17 and are for information only.

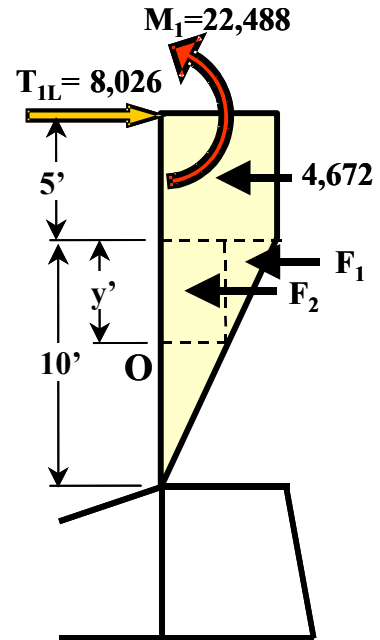

Figure 7-13. Zero shear

Caltrans Trenching and Shoring Check Program, Single Tiebacks

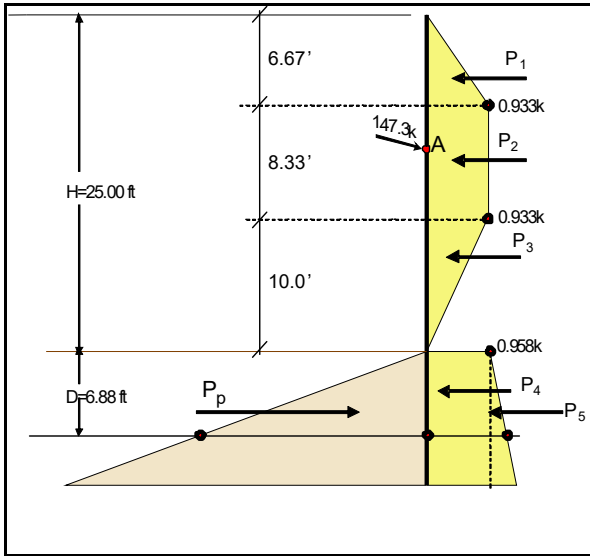

Figure 7-14. Pressure Diagram

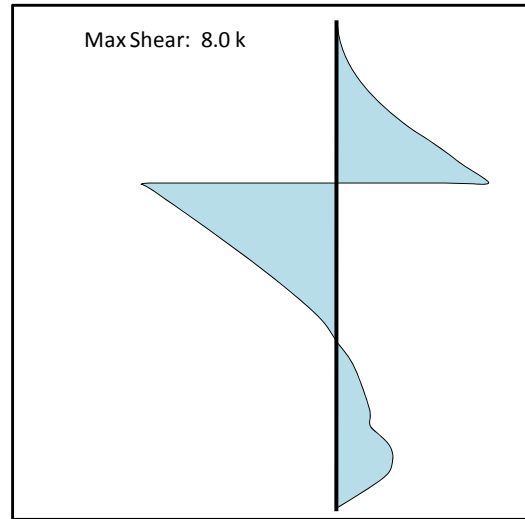

Figure 7-15. Shear Diagram

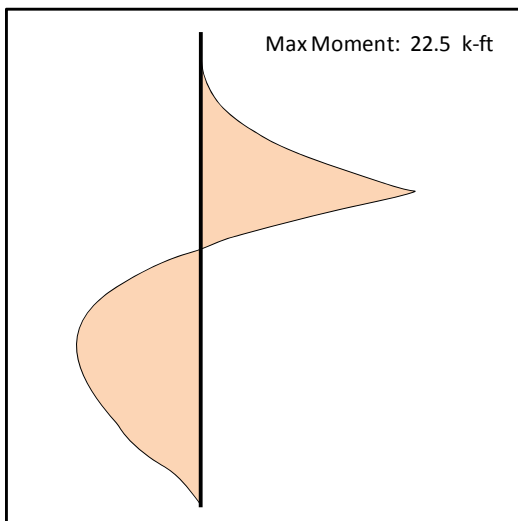

Figure 7-16. Moment Diagram

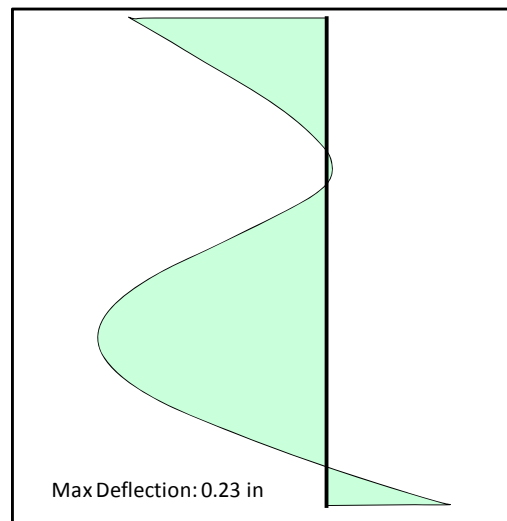

Figure 7-17. Deflection Diagram

7.3.5 Example 7-2 Multiple Tieback Sheet Pile Wall

Check the adequacy of a multiple tieback sheet pile wall with a single soil layer shown below with a tieback spacing = 10 feet. The sheet pile section is a PZ22, steel grade 42 ksi.

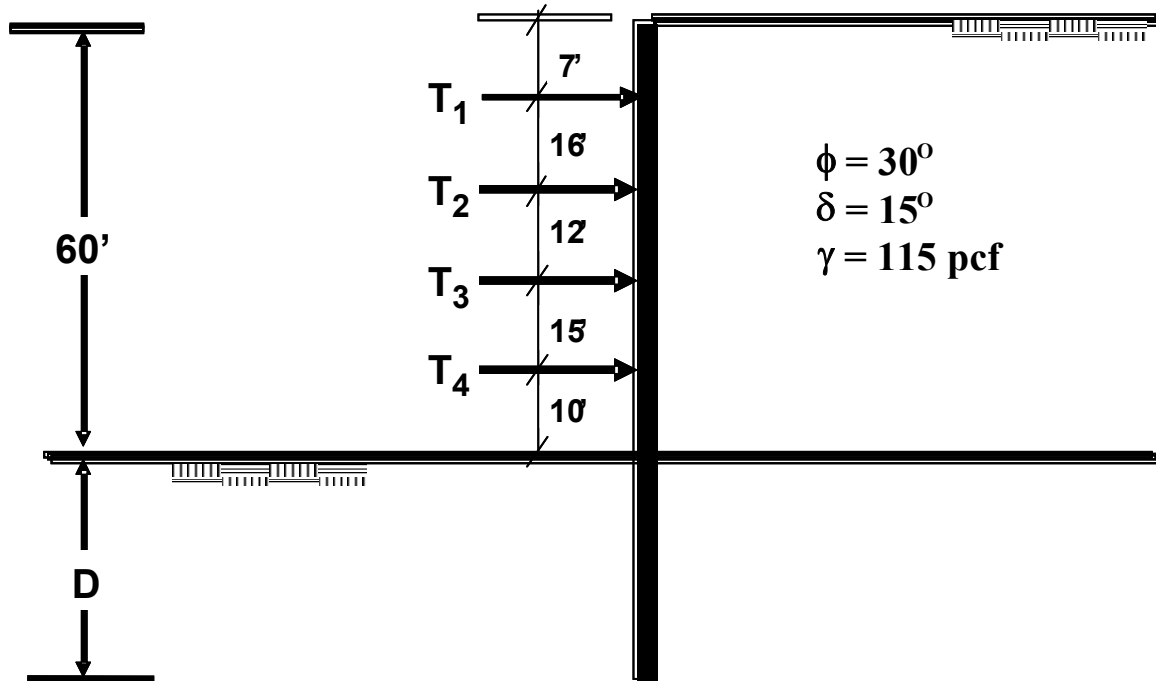

Figure 7-18. Example 7-2

Determine:

1. Active & Passive Earth Pressures.
2. Pile Embedment D with a FS of 1.3.
3. Tieback Loads with a FS of 1.0.
4. Maximum Shear, Moment and Deflection.

Structural properties of the PZ22 are:

- Section Modulus per foot of wall width: $S = 18.10 \text{ in}^3$.
- Moment of Inertia per foot of wall width: $I = 84.70 \text{ in}^4$.
- Radius of Gyration per foot of wall width: $r = 3.62 \text{ in}$.
- Area per foot of wall width: $A = \frac{I}{r^2} = \frac{84.7 \text{ in}^4}{(3.62 \text{ in})^2} = 6.46 \text{ in}^2$

Develop the pressure diagram:

From Rankine's Theory: $K_a = \frac{1}{3}$. Using the Log Spiral Theory, from Figure 4-37: $K_p = 4.7$.

The lateral earth pressure distribution for the analysis of braced or anchored walls constructed in cohesionless soils may be determined using Figure 7-19. The maximum ordinate (σ_a) of the pressure diagram is determined as follows:

$$\sigma_a = \left[\frac{P_T}{H - \frac{1}{3}(H_1 + H_2)} \right]$$

Where the total active earth pressure is calculated as follow:

$$P = \frac{1}{2}(115)(60^2) \left(\frac{1}{3} \right) = 69,000 \text{ lb/ft}$$

$$P_T = 1.3P = 1.3(69,000) = 89,700 \text{ lb/ft}$$

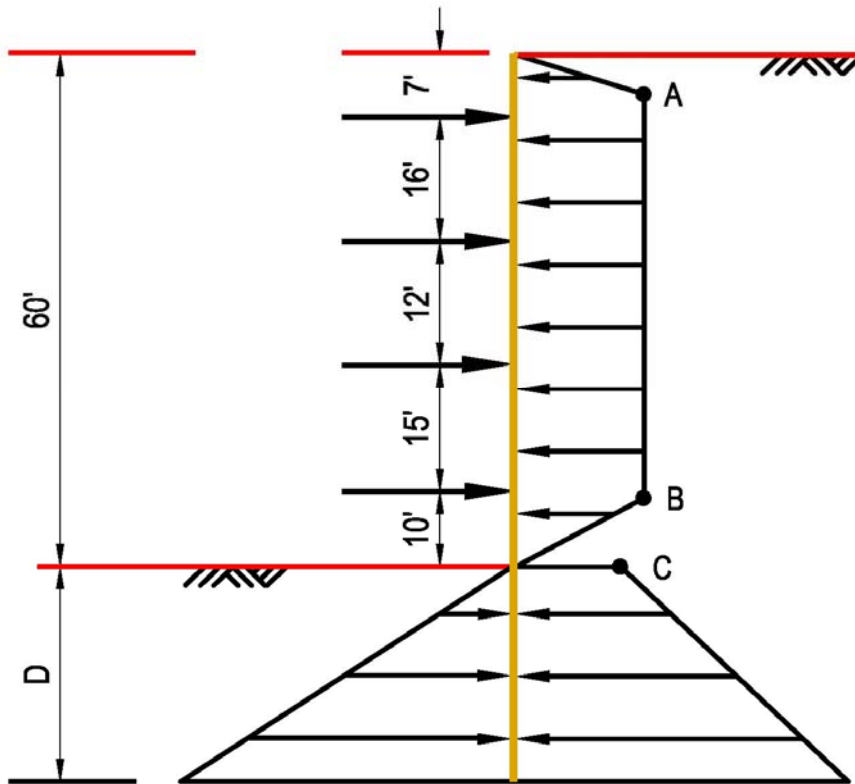

Figure 7-19. Pressure Diagram For Multi-Tieback

RESTRAINED SHORING SYSTEMS

Active stress at the point A and B as shown in Figure 7-19:

$$\sigma_a = \left[\frac{89,700}{60 - \frac{1}{3}(7+10)} \right] \approx 1,650 \text{ psf}$$

Active stress at the dredge line point C:

$$\sigma_c = (115)(60) \left(\frac{1}{3} \right) = 2,300 \text{ psf}$$

Determine forces due to trapezoidal pressure distribution:

$$F_1 = \frac{1}{2}(4.667)(1,650) \approx 3,850 \text{ lb}$$

$$F_2 = (2.333)(1,650) \approx 3,850 \text{ lb}$$

$$F_3 = (16)(1,650) = 26,400 \text{ lb}$$

$$F_4 = (12)(1,650) = 29,800 \text{ lb}$$

$$F_5 = (15)(1,650) = 24,750 \text{ lb}$$

$$F_6 = (3.33)(1,650) \approx 5,495 \text{ lb}$$

$$F_7 = \frac{1}{2}(6.67)(1,650) \approx 5,503 \text{ lb}$$

Determine moment M_1 at top tieback due to cantilever loads:

$$M_1 = F_1 * \text{Mom arm of triangular load} + F_2 * \text{Mom arm of rectangular load}$$

$$M_1 = (3850) \left(2.333 + \frac{4.667}{3} \right) + (3850) \left(\frac{2.333}{2} \right) \approx 19,462 \text{ lb - ft}$$

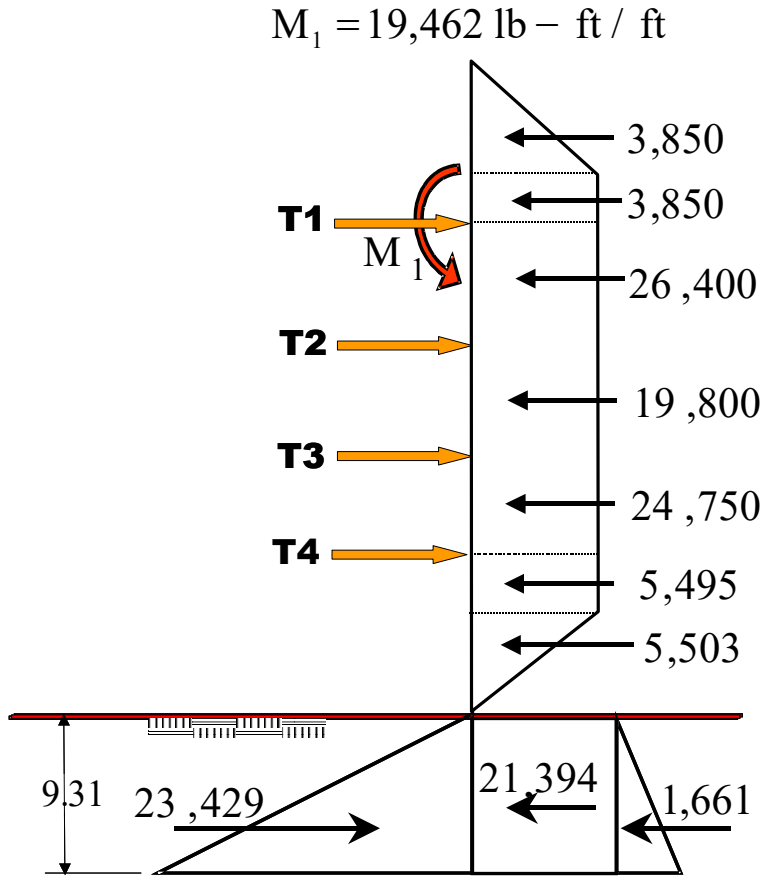

Figure 7-20. Pressure Diagram For Multi-Tieback Above Dredge Line

Note: D is calculated below.

RESTRAINED SHORING SYSTEMS

Determine tieback loads T_1 through T_3 and component T_{4U} . Component T_{4L} will be determined after D is calculated. Note, the subscript letters “U” refers to Upper and “L” refers to Lower components of each tieback. Also, the number 10 in the calculations below is the horizontal spacing of the tiebacks. Note that T_{1L} and T_{2U} include the effect of moment shear $19,462/16$ due to M_1 .

$$T_{1U} = 3,850 + 3,850 = 7,700 \text{ lb/ft}$$

$$T_{1L} = \left(\frac{26,400}{2} \right) + \left(\frac{19,462}{16} \right) \approx 14,416 \text{ lb/ft}$$

$$T_1 = \left[\frac{10(7,700 + 14,416)}{1000} \right] = 211.16 \text{ kips}$$

$$T_{2U} = \left(\frac{26,400}{2} \right) - \left(\frac{19,462}{16} \right) \approx 11,984 \text{ lb/ft}$$

$$T_{2L} = \left(\frac{19,800}{2} \right) = 9,900 \text{ lb/ft}$$

$$T_2 = \left[\frac{10(11,984 + 9,900)}{1000} \right] = 218.84 \text{ kips}$$

$$T_{3U} = T_{2L} = 9,900 \text{ lb/ft}$$

$$T_{3L} = \left(\frac{24,750}{2} \right) = 12,375 \text{ lb/ft}$$

$$T_3 = \left[\frac{10(9,900 + 12,375)}{1000} \right] = 222.75 \text{ kips}$$

$$T_{4U} = T_{3L} = 12,375 \text{ lb/ft}$$

Determine D' to calculate T_4 by taking moments about T_4 .

$$M_D = (5,495) \left(\frac{3.33}{2} \right) + (5,503) \left(3.33 + \frac{6.67}{3} \right) + (2300) \left(10 + \frac{D'}{2} \right) D' + \left(\frac{115}{2} \right) \left(\frac{1}{3} \right) \left(10 + \frac{2}{3} D' \right) D'^2$$

$$M_R = (4.7) \left(\frac{115}{2} \right) \left(10 + \frac{2}{3} D' \right) D'^2$$

Set $M_R = M_D$ and solve for D' .

$$D'^3 + 8.13D'^2 - 137.41D' - 237.24 = 0$$

$$D' \approx 9.31 \text{ ft}$$

Determine the lower component T_{4L} of tieback T_4 and calculate its load.

$$T_{4L} = 5,495 + 5,503 + (2,300)(9.31) + \left(\frac{115}{3}\right)\left(\frac{9.31^2}{2}\right) + (115)(4.7)\left(\frac{9.31^2}{2}\right)$$

$$T_{4L} = 5,495 + 5,503 + 21,413 + 1661 + 23,424 = 10,648 \text{ lb/ft}$$

$$T_4 = \left[\frac{10(12,375 + 10,648)}{1000} \right] = 230.23 \text{ kips}$$

Determine embedment D for external stability by taking moments about T_4 using factor of safety (FS) = 1.3.

Set $M_R = 1.3M_D$ and solve for D .

$$D^3 + 5.86D^2 - 182.81D - 315.61 = 0$$

$$D \approx 11.83 \text{ ft}$$

The maximum shear in the beam is located at one of the tiebacks. By inspection of the above calculations the Maximum Shear is located at the lower component of Tieback 1:

$$V_{MAX} = T_{1L} = 14,416 \text{ lbs}$$

Check the shear stress in the sheet pile section:

$$f_v = \frac{14,416 \text{ lbs}}{6.46 \text{ in}^2} = 2,230 \text{ psi} < 16,800 \text{ psi}$$

$$F_v = 42,000 \text{ psi} * 0.4 \approx 17,000 \text{ psi} \therefore \text{PZ22 is satisfactory in shear.}$$

Determine the maximum moment:

The maximum negative moment is located at Tieback 1:

$$M_{MAX-NEG} = M_1 = 19,462 \text{ ft} \cdot \text{lbs/ft}$$

Determine the maximum positive moments between the tiebacks:

$$M_{1-2} = -19,462 + \frac{1}{2}(14,416)(8.74') = 43,536 \text{ ft} \cdot \text{lbs/ft}$$

$$M_{2-3} = \frac{1}{2}(9,900)\left(\frac{1}{2}12'\right) = 29,700 \text{ ft} \cdot \text{lbs/ft}$$

$$M_{3-4} = \frac{1}{2}(12,375)\left(\frac{1}{2}15'\right) = 46,406 \text{ ft} \cdot \text{lbs/ft}$$

RESTRAINED SHORING SYSTEMS

Determine the maximum positive moment between T_4 and tip of the pile:

Sum forces in the horizontal direction to find zero shear at distance y below the lowest tieback:

$$\begin{aligned}\sum F_x &= 5405 + 5503 + 2300y + \frac{1}{2}(115)\left(\frac{1}{3}y\right) - \frac{1}{2}(115)(4.7y) = 0 \\ &= 251.08y^2 - 2300y - 10,988 = 0\end{aligned}$$

The result yields $y = 12.63'$ or $y = -3.46'$. Neither of these values is located within distance D' of 9.31 ft and therefore is not valid. Therefore the point of zero shear is located above the dredge line. Further, it can be surmised that the point of zero shear is located within the sloping portion of the load diagram below the T_4 since:

$$T_{4L} - (1,650)(3.33') = 10,648 \text{ lbs} - 5,495 \text{ lbs} = 5,153 \text{ lbs} > 0$$

The following will determine the point of zero shear above the dredge line: See Figure 7-21. Solving for y' :
(The slope of the line in the area of the assumed zero shear is $1650/6.67' = 247.38$.)

$$\begin{aligned}(10,648 - 5,495) &= \frac{1}{2}(1,650 + 1650 - 247.38y')y' = \\ (2)(5,153) &= 3,300y' - 247.38y'^2 \\ \therefore 247.38y'^2 - 3,300y' + 10,306 &= 0 \\ y' &= 4.99 \text{ ft}\end{aligned}$$

The point of zero shear is located at $3.33' + 4.99' = 8.32'$ below T_4 . Taking moments about point O:

$$\begin{aligned}M_{4\text{-tip}} &= -\frac{1}{2}(1,699)(4.99') - \frac{2}{3}(3,018)(4.99') - (5,495)\left(4.99' + \frac{3.33'}{2}\right) + (10,648)(8.32') = \\ &= -4,239 - 10,040 - 36,569 + 88,591 = 37,743 \text{ ft-lb/ft}\end{aligned}$$

Therefore the maximum moment is between T_3 and T_4 : $M_{3-4} = 46,406 \text{ ft-lb/ft}$

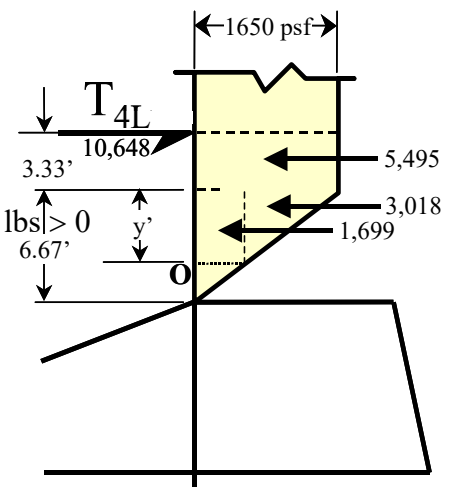

Figure 7-21. Point of zero shear

Check the bending stress in sheet pile section PZ22:

$$f_b = \frac{46,406 \text{ ft} \cdot \text{lb} * 12 \text{ in/ft}}{18.10 \text{ in}^3} = 30,766 \text{ psi}$$

$F_b = 42,000 \text{ psi} * 0.6 \approx 25,000 \text{ psi} \therefore$ Therefore, PZ22 is NOT satisfactory in bending.

The process used to check deflection can be found in Example 6-2 and EXAMPLE 8-1 and will not be calculated for this example. Figure 7-25 represents the deflected shape of the PZ22 sheet pile based on the Moment Area method; therefore, use these values with caution. The deflection due to the cantilever is 0.71 inches. The maximum deflection is 0.79 inches and is located about 8.6 ft below T_4 . The respective diagrams are shown in Figure 7-22 through Figure 7-25 and are for information only.

RESTRAINED SHORING SYSTEMS

Caltrans Trenching and Shoring Program Output Multiple Tieback

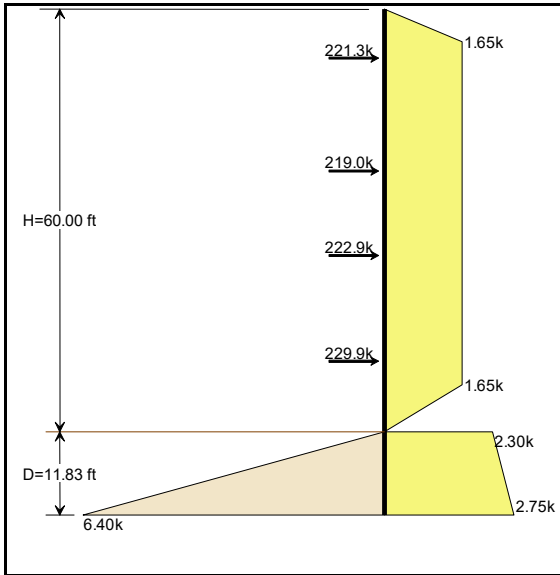

Figure 7-22. Pressure Diagram

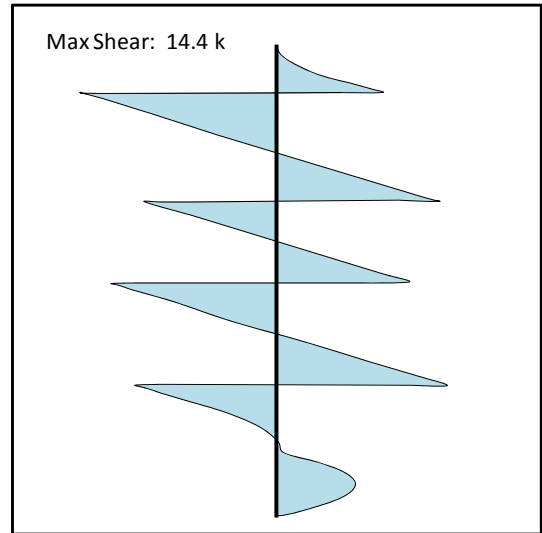

Figure 7-23. Shear Diagram

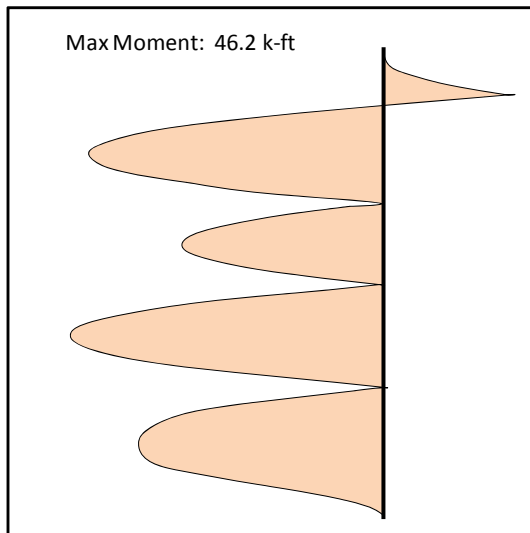

Figure 7-24. Moment Diagram

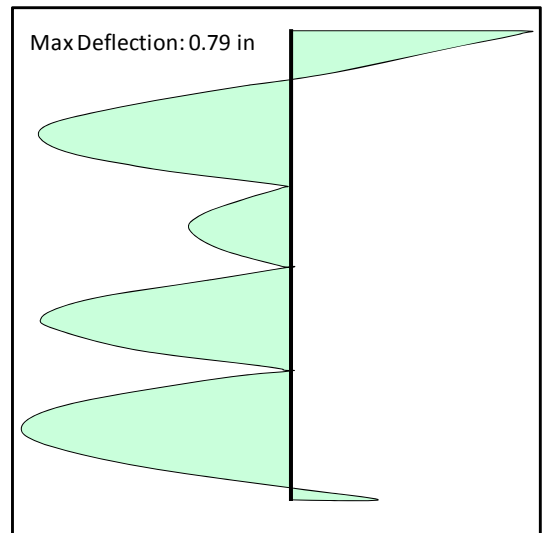
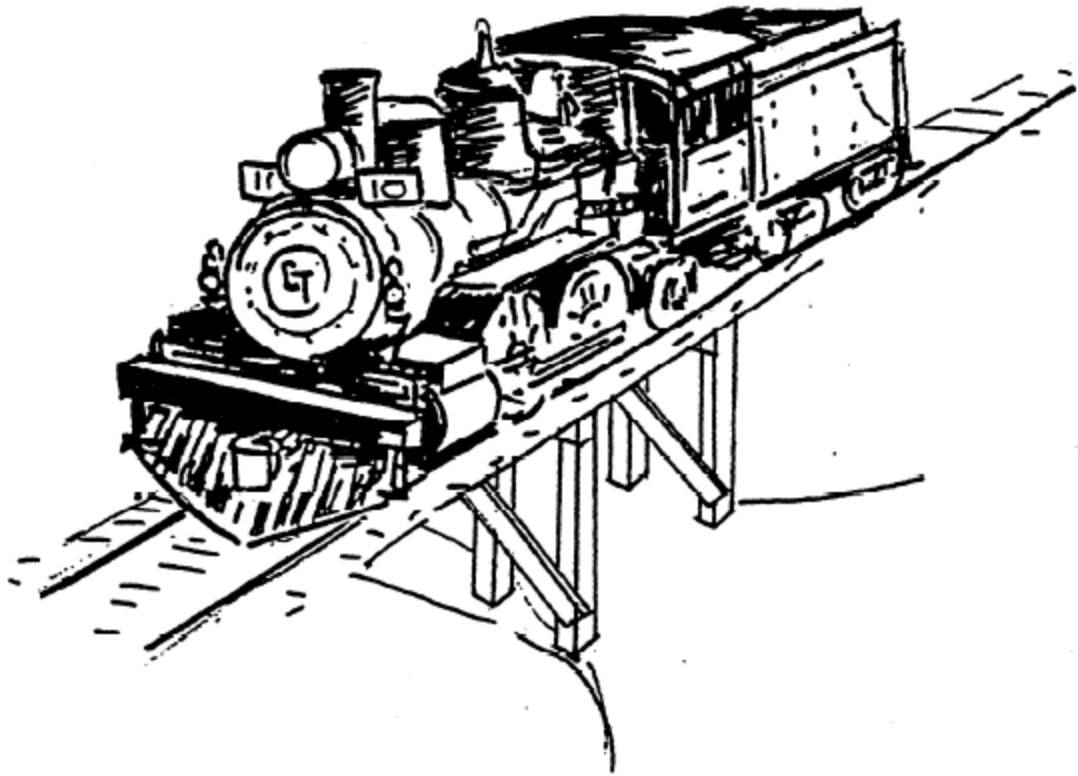

Figure 7-25. Deflection Diagram

CHAPTER 8

RAILROAD



8.0 INTRODUCTION

Shoring adjacent to railroads present additional challenges in both the review and construction phases. For the purposes of this Manual, the term “Railroad” will refer to the Burlington Northern and Santa Fe Railway (BNSF) and the Union Pacific Railroad (UPRR). In the course of the work, SC engineers may encounter other railways such as light rail and commuter trains like Bay Area Rapid Transit (BART). For these other railways, it is acceptable to use the same guidelines presented here unless there are specific instructions from the concerned railway.

This chapter is developed using the UPRR General Shoring Requirements and the Guidelines for Temporary Shoring published by BNSF and UPRR in 2004. The Guidelines were designed as a supplement to the 2002 American Railway Engineering and Maintenance-of-Way Association (AREMA) Manual of Recommended Practice. When reviewing shoring that encroaches on railroad right-of-way, always ensure that the most current editions of both documents are being used. When the railroad requirements conflict with Caltrans or OSHA specifications, always use the more conservative specification.

Standard Specifications Section 19-1.02, “Preservation of Property,” requires excavation plans to be submitted at least 9 weeks prior to beginning of construction. As well as meeting the requirements of the Standard Specifications, contracts with Railroad involvement will include a section in the Special Provisions titled “Railroad Relations and Insurance,” typically Section 13. Section 13 will include general requirements for the design and construction of temporary shoring and provide reference to additional information and requirements.

The Engineer will be responsible for reviewing the submittal package for compliance and accuracy in the same manner as any other shoring system. Special attention should be paid to the plan and calculation requirements in the “Guidelines for Temporary Shoring.” Submissions of the Plans and Calculations to the Railroad are to be routed through the Offices of Structure Construction Headquarters in Sacramento (OSC HQ) in accordance with BCM 122-1.0. The OSC HQ will be the Engineer’s single point of contact with the Railroad through the submittal phase. The Railroad may take 6 weeks or more to review the shoring plans and calculations. The contractor may not begin work on any part of the shoring system until Caltrans receives written approval from the Railroad.

Live loads for Railroads are based on the Cooper E80 loading. Cooper E80 is designed to approximate 2 locomotives with 80 kips per axle pulling an infinite train of 8 kips per foot. The lateral pressure from the loading will be determined using the Boussinesq Strip Loading procedure. Since the live loading is considered to be dynamic, use of wall friction in the earth pressure calculations will not be allowed above

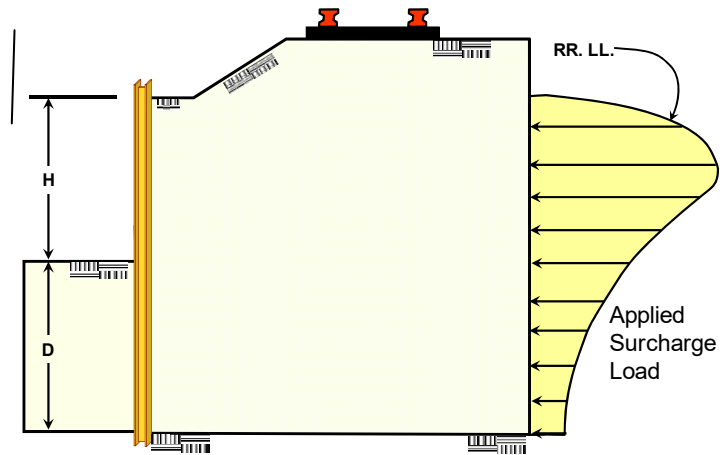

Figure 8-1. Railroad Boussinesq Strip Load

the dredge line. When using the railroad (RR) live load (LL) curves, the plot of the curve always starts at the elevation of the top of the shoring system as shown in Figure 8-1.

8.1 **SELECTED EXCERPTS FROM “Guidelines for Temporary Shoring, Published October 25, 2004, BNSF/UPRR” (GTS)**

8.1.1 **Scope (GTS section 1, p1)**

These guidelines are developed to inform public agencies, design engineers, contractors and inspectors of current Railroad standards and requirements concerning the design and construction of temporary shoring. The temporary shoring addressed below can be used for all locations where the Railroad operates regardless of track ownership. For any items not covered in this CT Shoring Manual, please refer to the Guidelines for Temporary Shoring as published by BNSF and/or UPRR and the AREMA Manual. Throughout the entire construction, all personnel, railroad tracks, and property need to be protected to ensure the safety and economy of the project.

8.1.2 **General Criteria (GTS section 2, p1 - 2)**

The contractor must not begin construction of any component of the shoring system affecting the Railroad right-of-way until written Railroad approval has been received.

1. All excavations shall be in compliance with applicable OSHA regulations and shall be shored where there is any danger to tracks, structures or personnel regardless of depth.

RAILROADS

2. Contractor is responsible for planning and executing all procedures necessary to construct, maintain and remove the temporary shoring system in a safe and controlled manner.
3. Emergency Railroad phone numbers are to be obtained from the Railroad representative in charge of the project prior to the start of any work and shall be posted at the job site.
4. Contractor must obtain a valid right of entry permit from the Railroad and comply with all railroad requirements when working on Railroad property.
5. The Contractor is required to meet minimum safety standards as defined by the Railroad.
6. All temporary shoring systems that support or impact the Railroad's tracks or operations shall be designed and constructed to provide safe and adequate rigidity.
7. The Railroad requirements, construction submittal review times and review criteria should be discussed at the pre-construction meeting with the Contractor.
8. A flagman is required when any work is performed within 25 feet of track centerline. If the Railroad provides flagging or other services, the Contractor shall not be relieved of any responsibilities or liabilities as set forth in any document authorizing the work. No work is allowed within 50 feet of track centerline when a train passes the work site and all personnel must clear the area within 25 feet of track centerline and secure all equipment when trains are present.
9. Appropriate measures for the installation and protection of fiber optic cables shall be addressed in the plans and contract documents. For specific Railroad requirements and additional information refer to:
www.bnsf.com or call 1-800-533-2891.
www.uprr.com, call 1-800-336-9163 or refer to UPRR Fiber Optic Engineering, Construction and Maintenance Standards.
- 10 Relocation of utilities or communication lines not owned by the Railroad shall be coordinated with the utility owners. The utility relocation plans must then be submitted to the Railroad utility representative for approval. The shoring plans must include the correct contact for the Railroad, State or Local utility locating service

provider. The Railroad will not be responsible for costs associated with any utility, signal or communication line relocation or adjustments.

8.1.3 Types of Temporary Shoring (GTS section 5, p5)

8.1.3.1 Shoring Box

A shoring box is considered a prefabricated system and is not accepted by the Railroad. The shoring system is installed as the excavation progresses. The system can be used, however, only in special applications when the Railroad live load surcharge is not present. During excavation, the shoring box is moved down by gravity or by applying vertical loading from excavation equipment.

8.1.3.2 Restrained Systems

Restrained systems are comprised of vertical elements, (continuous sheet piles or discrete soldier piles with lagging) and horizontal elements (braces or tiebacks). Restrained systems are designed to provide lateral support for the soil mass supporting the Railroad and derives their stability from the passive resistance of the vertical structural element against soil below the excavation line and the horizontal components of the anchored or braced elements.

Restrained systems with tiebacks are discouraged by the Railroad. The tiebacks become an obstruction to future utility installations and may also damage existing utilities. All tiebacks must be removed per Railroad requirements. Tiebacks must be designed, furnished, installed, tested and stressed in accordance with AREMA requirements.

8.1.3.3 Unrestrained Systems

Unrestrained systems are comprised of only vertical elements, (continuous sheet piles or discrete soldier piles with lagging). Unrestrained systems are designed to provide lateral support for the soil mass supporting the Railroad and derive their stability solely from the passive resistance of the vertical structural element against soil below the excavation line.

8.1.3.4 Cofferdam

A cofferdam is designed to keep water and soil out of an excavation. This enclosed temporary structure helps with the construction of a permanent structure, such as a bridge

RAILROADS

pier or abutment or similar structure. Cofferdams are usually constructed out of timber, steel, concrete, or a combination of any of these materials. In most cases, the guidelines designate cofferdams to be constructed with steel sheet piles.

8.1.4 General Shoring Requirements (GTS section 6, p5 - 7)

For general shoring requirements and specific applications of the following items refer to Figure 8-2. The general requirements per the Guidelines for Temporary Shoring are described below:

1. No excavation shall be permitted closer than 12'-0" measured at a right angle from the centerline of track to the trackside of shoring system. If existing conditions preclude the installation of shoring at the required minimum distance, the shifting of tracks or temporary removal of tracks shall be investigated prior to any approval. All costs associated with track shifting or traffic interruption shall be at Contractor's expense.
2. Evaluate slope and stability conditions to ensure the Railroad embankment will not be adversely affected. Local and global stability conditions must also be evaluated.
3. All shoring within the limits of Zone A or Zone B must be placed prior to the start of excavation.
4. Lateral clearances must provide sufficient space for construction of the required ditches parallel to the standard roadbed section. The size of ditches will vary depending upon the flow and terrain and should be designed accordingly.
5. The shoring system must be designed to support the theoretical embankment shown in zones A and B.
6. Any excavation, holes, or trenches on the Railroad property shall be covered, guarded and/or protected. Handrails, fence, or other barrier methods must meet OSHA and Federal Railroad Administration (FRA) requirements. Temporary lighting may also be required by the Railroad to identify tripping hazards to train crewmen and other Railroad personnel.
7. The most stringent project specifications of the Public Utilities Commission Orders, Department of Industrial Safety, OSHA, FRA, AREMA, BNSF, UPRR or other governmental agencies shall be used.

8. Secondhand material is not acceptable unless the Engineer of Record submits a full inspection report that verifies the material properties and condition of the secondhand material. The report must be signed and sealed by the Engineer of Record.
9. All components of the shoring system are to be removed when the shoring is no longer needed. All voids must be filled and drainage facilities restored.
10. Slurry type materials are not acceptable as fill for soldier piles in drilled holes. Concrete and flowable backfill may prevent removal of the shoring system. Use compacted pea gravel material.

8.1.5 Information Required (GTS section 4, p3 - 4)

Plans and calculations shall be submitted signed and stamped by a Registered Professional Engineer familiar with Railroad loadings and who is licensed in the state where the shoring system is intended for use. Information shall be assembled concerning right-of-way boundary, clearances, proposed grades of tracks and roads, and all other factors that may influence the controlling dimensions of the proposed shoring system.

8.1.5.1 Field Survey

Sufficient information shall be shown on the plans in the form of profiles, cross sections and topographical maps to determine general design and structural requirements. Field survey information of critical or key dimensions shall be referenced to the centerline of track(s) and top of rail elevations. Existing and proposed grades and alignment of tracks and roads shall be indicated together with a record of controlling elevation of water surfaces or ground water. Show the location of existing/proposed utilities and construction history of the area that might hamper proper installation of the piling, soldier beams, or ground anchors.

8.1.5.2 Geotechnical Report

- a. Elevation and location of soil boring in reference to the track(s) centerline and top of rail elevations.
- b. Classification of all soils encountered.
- c. Internal angle of soil friction
- d. Dry and wet unit weights of soil.

RAILROADS

- e. Active and passive soil coefficients, pressure diagram for multiple soil strata.
- f. Bearing capacity and unconfined compression strength of soil.
- g. Backfill and compaction recommendations.
- h. Optimum moisture content of fill material.
- i. Maximum density of fill material.
- j. Minimum recommended factor of safety.
- k. Water table elevation on both sides of the shoring system.
- l. Dewatering wells proposed flownets or zones of influence.
- m. In seismic areas, evaluation of liquefaction potential of various soil strata.

8.1.5.3 Loads

All design criteria, temporary and permanent loading must be clearly stated in the design calculations and on the contract and record plans. Temporary loads include, but are not limited to: construction equipment, construction materials and lower water levels adjoining the bulkhead causing unbalanced hydrostatic pressure. Permanent loads include, but are not limited to: future grading and paving, Railroads or highways, structures, material storage piles, snow and earthquake. The allowable live load after construction should be clearly shown in the plans and painted on the pavements behind the bulkheads or shown on signs at the site and also recorded on the record plans. Some of the loads are:

- a. Live load pressure due to E80 loading for track parallel to shoring system.
- b. Live load pressure due to E80 loading for track at right angle to shoring system.
- c. Other live loads.
- d. Active earth pressure due to soil.
- e. Passive earth pressure due to soil.
- f. Active earth pressure due to surcharge loads.
- g. Active pressure due to sloped embankment.
- h. Dead load.
- i. Buoyancy.
- j. Longitudinal force from live load.
- k. Centrifugal forces.
- l. Shrinkage.
- m. Temperature.

- n. Earthquake.
- o. Stream flow pressure.
- p. Ice pressure.

8.1.5.4 Drainage (AREMA 8.20.2.4)

- a. The drainage pattern on the site before and after construction should be analyzed and adequate drainage provisions should be incorporated into the plans and specifications. Consideration should be given to groundwater as well as surface drainage.
- b. Drainage provisions for backfill should be compatible with the assumed water conditions in design.

8.1.5.5 Structural Design Calculations

- a. List all assumptions used to design the temporary shoring system.
- b. Determine E80 live load lateral pressure using the Boussinesq strip load equation.
- c. Computerized calculations and programs must clearly indicated the input and output data. List all equations used in determining the output.
- d. Example calculations with values must be provided to support computerized output and match the calculated computer result.
- e. Provide a simple free body diagram showing all controlling dimensions and applied loads on the temporary shoring system.
- f. Calculated lateral deflections of the shoring and effects to the rail system must be included. Include the elastic deflection of the wall as well as the deflection due to the passive deflection of the resisting soil mass.
- g. Documents and manufacturer's recommendations that support the design assumptions must be included with the calculations.

8.1.5.6 Computation of Applied Forces (GTS section 7, p7 - 8)

Below are all the applied forces that need to be taken into consideration when designing for a Railroad system.

- 1. Railroad live and lateral forces.

RAILROADS

- a. For specific applications of the Coopers E80 live load refer to Figure 8-3 and Figure 8-4.
2. Dead Load.
 - a. Spoil pile: must be included assuming a minimum height of two feet of soil adjacent to the excavation.
 - b. Track: use 200 lbs/linear ft for rails, inside guardrails and fasteners.
 - c. Roadbed: ballast, including track ties, use 120 lb per cubic foot.
3. Active and passive earth pressures.
 - a. The active and passive earth pressures may be computed by any approved method.
4. Active earth pressure due to unbalanced water pressure.
 - a. When bulkheads are used for waterfront construction, the bulkhead is subjected to a maximum earth pressure at the low water stage. During a rainstorm or a rapidly receding high water, the water level behind the bulkhead may be several feet higher than in front of the bulkhead.
 - b. Drained conditions in backfill apply when clean sand or clean sand and gravel are used and adequate permanent drainage outlets are provided. Where drained conditions exist, the design water level may be assumed at the drainage outlet elevation.
5. Pressure due to embankment surcharges.
 - a. Conventional analysis should be used to determine the additional surcharge from embankment slope.
6. Additional analysis for centrifugal force calculations as described in the AREMA Manual is required where track curvature exceeds three degrees.
7. Include and compute all other loads that are impacting the shoring system such as a typical Railroad service vehicle.

8.1.5.7 Structural Integrity (GTS section 8, p9 - 10)

Structures and structural members shall be designed to have design strengths at all sections at least equal to the required strengths calculated for the loads and forces in such combinations as stipulated in the AREMA Manual, which represents various combinations of loads and forces to which a structure may be subjected. Each part of the

CT TRENCHING AND SHORING MANUAL

structure shall be proportioned for the group loads that are applicable, and the maximum design required shall be used.

1. Embedment depth.
 - a. Calculated depth of embedment is the embedment depth required to maintain static equilibrium.
 - b. Minimum depth of embedment is the total depth of embedment required to provide static equilibrium plus additional embedment due to the minimum factor of safety.
 1. Embedment depth factor of safety for well-defined loading conditions and thoroughly determined soil parameters is generally 1.3 for most temporary shoring systems.
 2. All anchored shoring systems require a minimum embedment depth of 1.5 times the calculated depth of embedment. Shallow penetration into strong soil layers is not acceptable.
2. The allowable stresses based on AREMA requirements are as follows:

Structural Steel:

 - 0.55F_y for compression in the extreme fiber. (AREMA Ch.15 Table 1-11)
 - 0.35F_y for shear. (AREMA Ch.15 Table 1-11)

Sheet Pile Sections: 2/3 of yield strength for steel. (AREMA 8.20.5.7)

Concrete: 1/3 of compressive strength. (AREMA 8.20.5.7)

Anchor Rods: ½ of yield strength for steel. (AREMA 8.20.5.7)
3. AISC allowances for increasing allowable stress due to temporary loading conditions are not acceptable.
4. Gravity type temporary shoring systems must also be analyzed for overturning, sliding and global stability.
5. Calculated deflections of temporary shoring system and top of rail elevation shall not exceed the criteria outlined in Table 8-1 Deflection Criteria.

RAILROADS

Table 8-1. Deflection Criteria

Horizontal distance from shoring to track C/L measured at a right angle from track	Maximum horizontal movement of shoring system	Maximum acceptable horizontal or vertical movement of rail
$12' < S < 18'$	3/8"	1/4"
$18' < S < 24'$	1/2"	1/4"

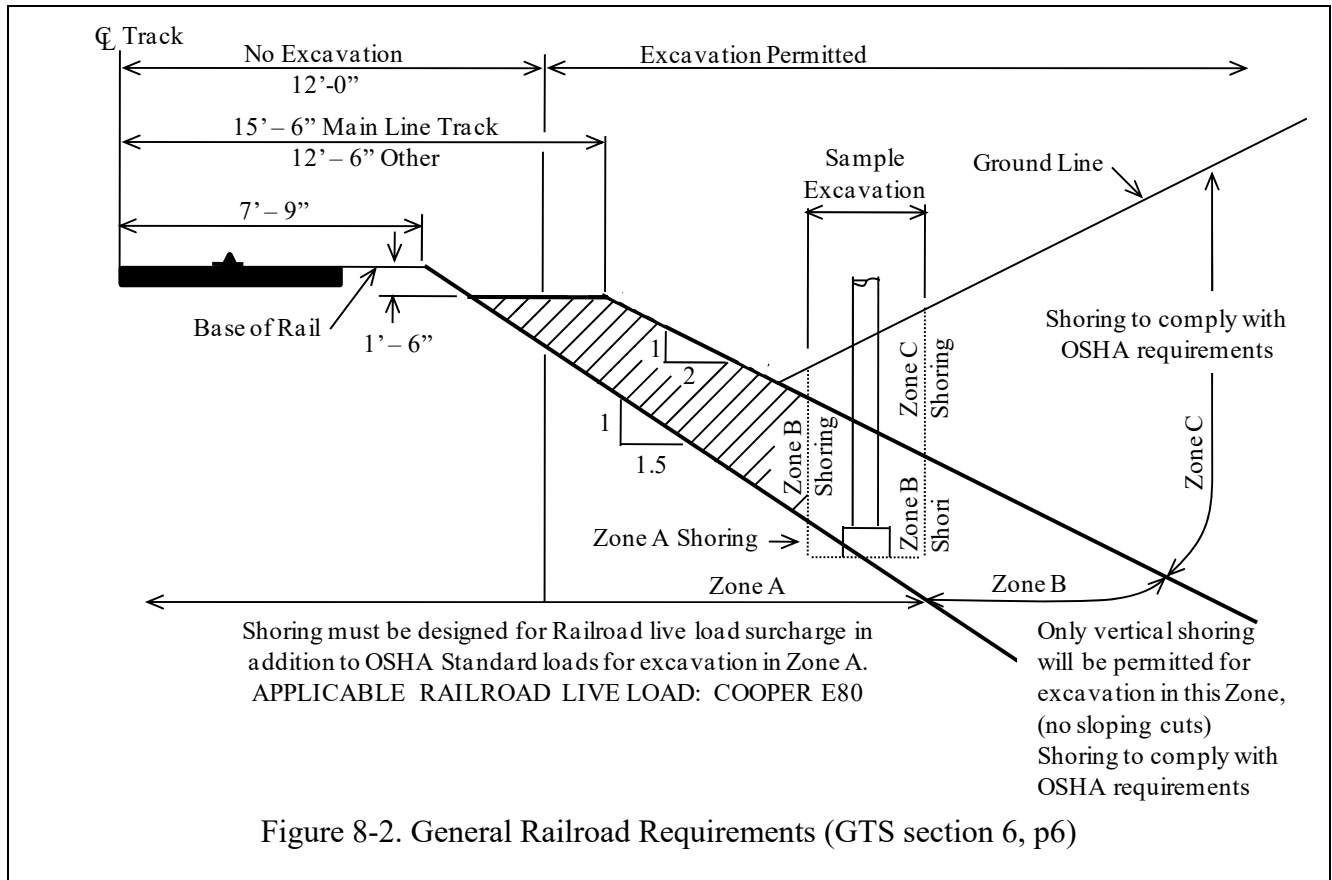

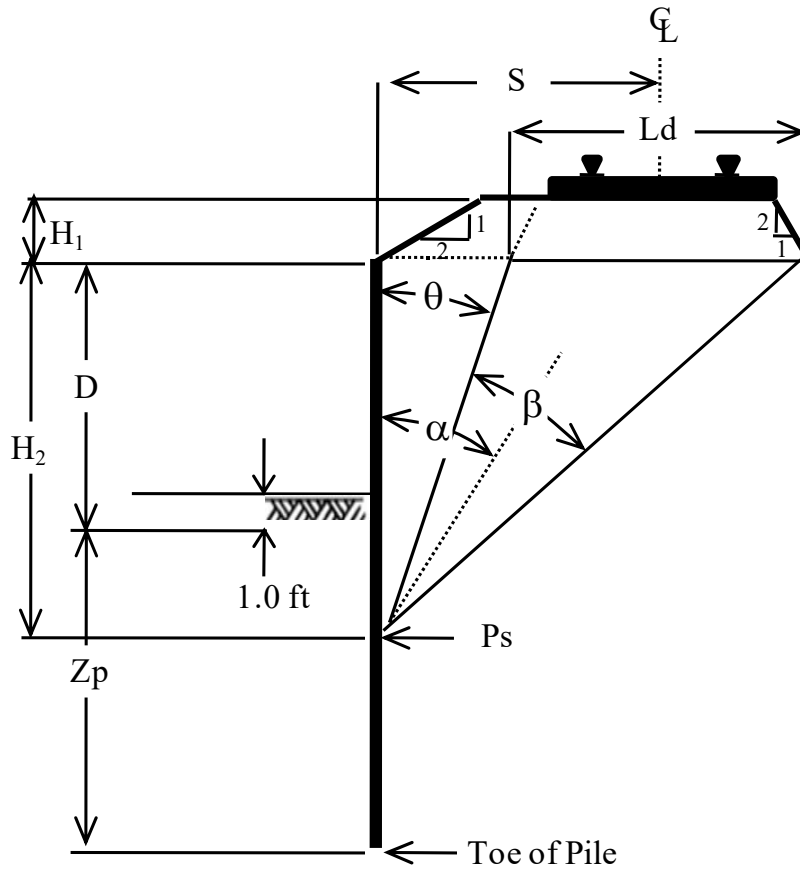

Figure 8-3. Live Load Pressure due to Cooper E80 (GTS section 7, p8)

Vertical Pressure, q , shall be based on distribution width L_d .

Where:

L_d = Length of the tie plus H_1 .

H_1 = Height from the bottom of tie to the top of shoring

H_2 = Depth of point being evaluated with Boussinesq equation

S = The distance perpendicular from centerline of track to the face of shoring

D = The distance from top of shoring to one foot below dredge line.

Z_p = The minimum embedment depth

q = The intensity of strip load due to E80 Railroad live load and can be calculated as follows:

For $H_1 = 0$, L_d = Length of Tie or

For $H_1 > 0$, L_d = Length of Tie + H_1

$$q = \frac{80,000}{5 \text{ ft}(L_d)}$$

RAILROADS

Case 1: Lateral live load pressure P_s , due to E80 loading for track parallel to shoring system is calculated using the Boussinesq Strip Load Equation

$$P_s = \frac{2q}{\pi} (\beta + \sin \beta \sin^2 \alpha - \sin \beta \cos^2 \alpha) = \frac{2q}{\pi} (\beta - \sin \beta \cos(2\alpha))$$

Where α and β are angles measured in radians,

$$\alpha = \theta + \frac{\beta}{2}$$

Case 2: Live load pressure due to E80 loading for track at a right angle to the shoring system can be calculated using the following equation:

$$P_s = K_a q$$

Where K_a is the active earth pressure coefficient.

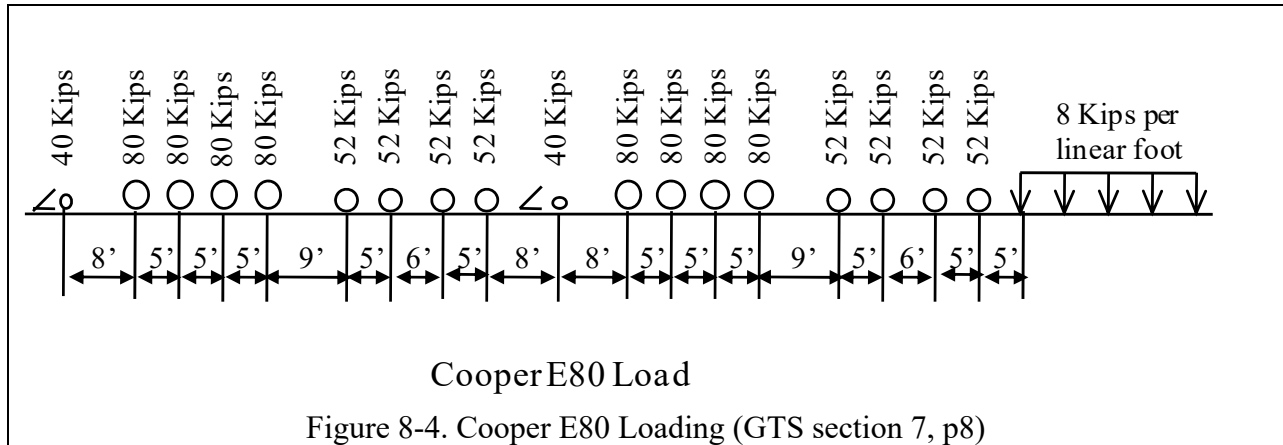

8.2 EXAMPLE 8-1 (Railroad Example)

Check a temporary shoring system adjacent to the railroad shown below.

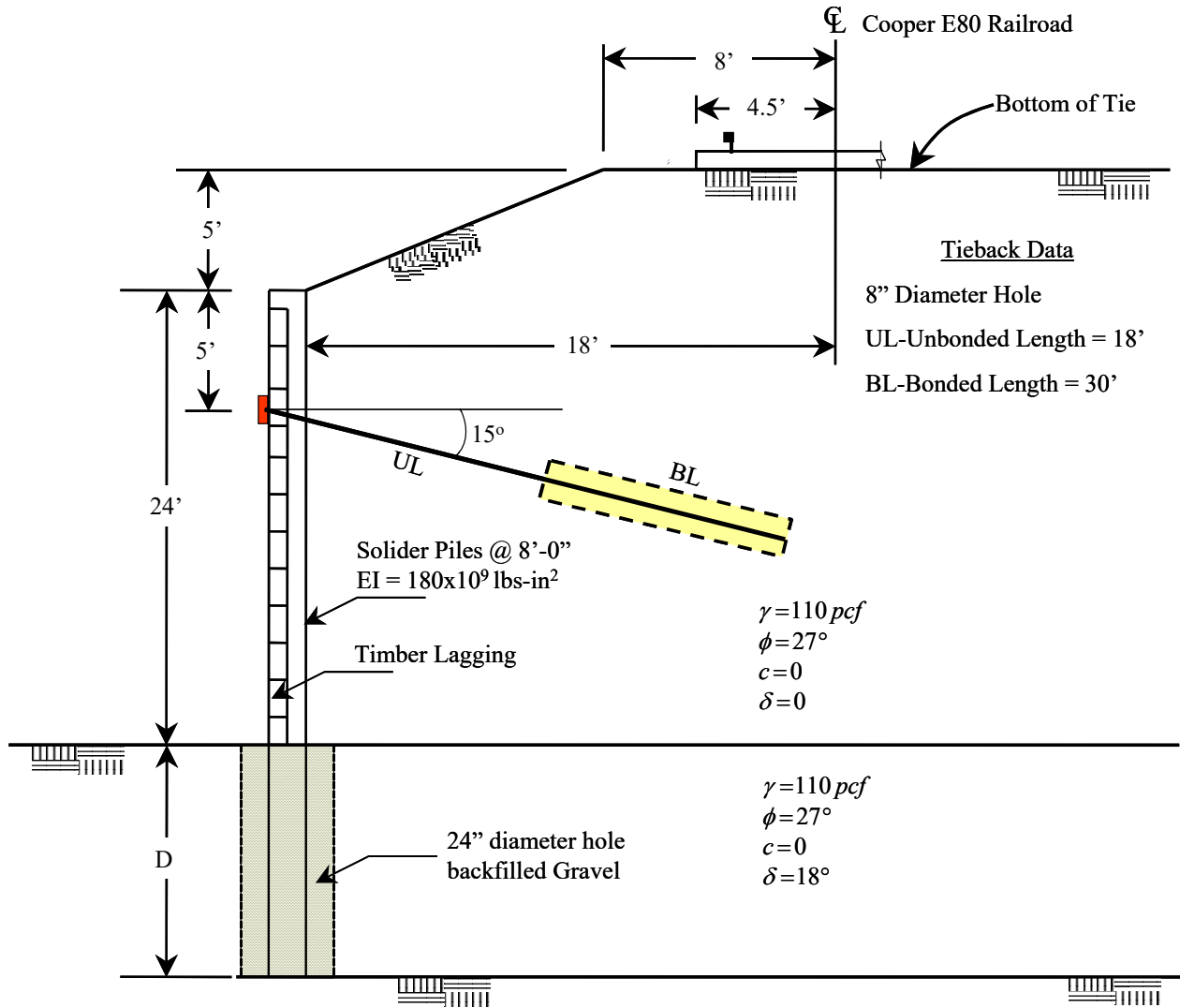

Figure 8-5. EXAMPLE 8-1

Determine:

1. Active & Passive Earth Pressures.
2. Pile Embedment D per Section 8.1.5.7 of this chapter.
3. Tieback Load with FS = 1.0.
4. Check the deflection of the shoring system per Railroad requirements.

STEP 1: Develop the Pressure Diagram

The appropriate pressure diagram should be broken down into diagrams: above the excavation line, below the excavation line, and the Railroad surcharge load.

For pressure Diagram above the excavation line ($H = 24$ feet and $\delta = 0^\circ$ due to vibrations from the RR in which case wall friction is ignored):

Calculate active earth pressure above excavation line using Trial Wedge Method formulation shown below.

$$P_A = \frac{W[\tan(\alpha - \phi)]}{[1 + \tan \delta \tan(\alpha - \phi)] \cos \delta} \quad (\text{Eq. 4-42})$$

The final wedge is shown below with the wedge angle of 55.92 degrees.

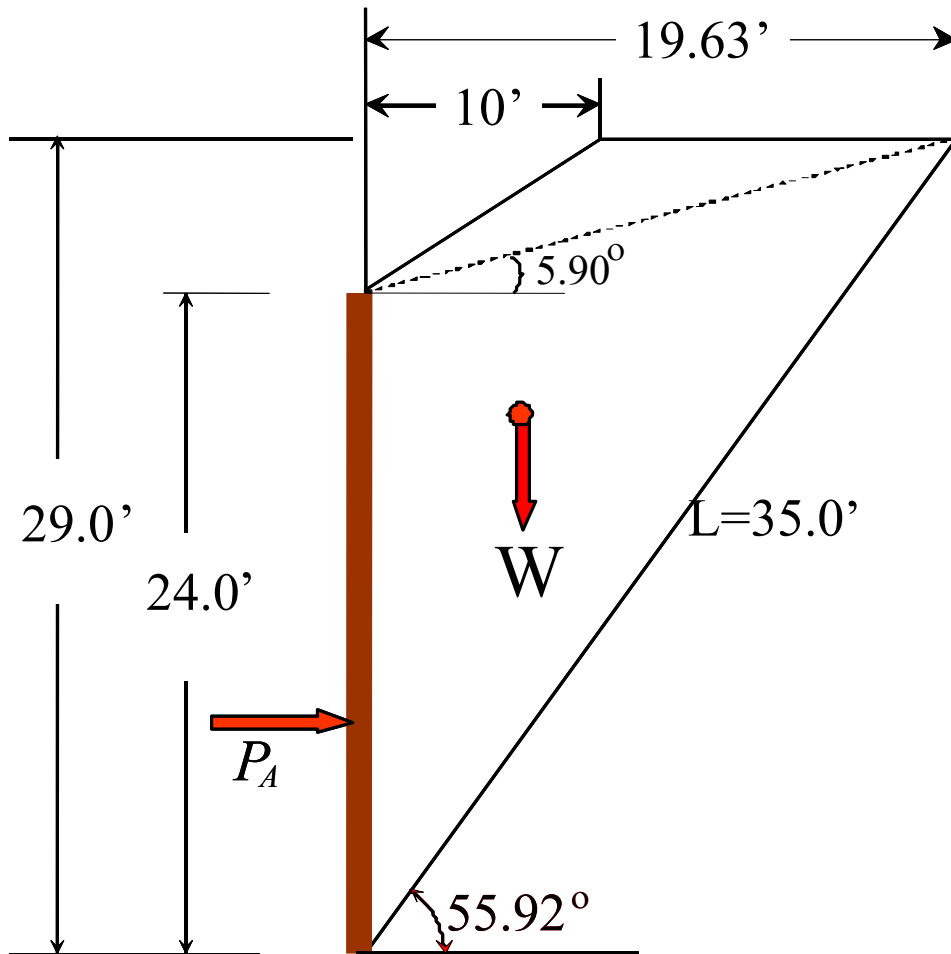

Figure 8-6. Final Trial Wedge For EXAMPLE 8-1

$$y_1 = 29.0 \text{ ft}$$

$$y_2 = 24.0 \text{ ft}$$

$$x_1 = 10.0 \text{ ft}$$

$$x_2 = 19.6 \text{ ft}$$

$$L = 35.0 \text{ ft}$$

$$Area = \frac{y_1(x_2 - x_1) + y_2x_1}{2} = \frac{29.0(19.63 - 10.0) + 24.0(10.0)}{2} = 259.64 \text{ ft}^2 / \text{ft}$$

$$W = A\gamma = \frac{259.64(110)}{1000} = 28.56 \text{ klf}$$

$$P_A = \frac{W[\tan(\alpha - \phi)]}{[1 + \tan \delta \tan(\alpha - \phi)] \cos \delta} = \frac{28.56 \tan(55.92 - 27)}{[1 + \tan(0)\tan(55.92 - 27)] \cos(0)} \approx 15.8 \text{ klf}$$

The P_A developed in the above equation will be used to determine the pressure diagram above excavation. (Use this P_A to determine trapezoidal load.)

$$\sigma_{Trapezoid} = \frac{1.3P_A}{\frac{2}{3}H} = \frac{1.3(15,800)}{\frac{2}{3}(24)} = 1,283.75 \text{ psf} \quad (\text{Eq. 7-1 and Eq. 7-2})$$

For pressure diagram below the excavation line ($H > 24$ feet):

The horizontal active earth pressure coefficient (Eq. 4-20) and horizontal passive earth pressure coefficient (Eq. 4-22) are determined using Coulomb's Earth Pressure theory. Please note that the earth pressure coefficient using the Coulomb method or the log spiral methods alluded to in CHAPTER 4 is similar since the soil friction angle is low.

$$k_{ah} = \frac{\cos^2(\phi)}{\cos(\delta) \left[1 + \sqrt{\frac{\sin(\delta + \phi)\sin(\phi)}{\cos(\delta)}} \right]^2} \cos(\delta) = \frac{\cos^2(27)}{\cos(18) \left[1 + \sqrt{\frac{\sin(45)\sin(27)}{\cos(18)}} \right]^2} \cos(18) = 0.318$$

$$k_{ph} = \frac{\cos^2(\phi)}{\cos(\delta) \left[1 - \sqrt{\frac{\sin(\delta + \phi)\sin(\phi)}{\cos(\delta)}} \right]^2} \cos(\delta) = \frac{\cos^2(27)}{\cos(18) \left[1 - \sqrt{\frac{\sin(45)\sin(27)}{\cos(18)}} \right]^2} \cos(18) = 4.521$$

Lateral load distribution at excavation line:

$$\sigma_{a1} = \gamma(H = 24 \text{ ft})k_a = 110(24)(0.318) = 839.52 \text{ psf}$$

Lateral load distribution at D ft below excavation line:

$$\sigma_{a2} = \sigma_{a1} + \gamma(D)k_a = 839.52 + 110(D)(0.318) = (839.52 + 34.98D) \text{ psf}$$

RAILROADS

Calculate passive earth pressure at D ft below excavation line:

$$\sigma_{p1} = \gamma (D) k_p = 110 (D)(4.521) = 497.31D \text{ psf}$$

Surcharge Load: See Section 4.8.1 of CHAPTER 4 for a discussion on the minimum surcharge load. In this example, a minimum surcharge of 72 psf must be applied at the top the shoring system. The Engineer is reminded to verify the governing surcharge for all scenarios. In addition, the Boussinesq load will be applied to the entire depth of the shoring system. The application of the surcharge load also begins at the top of the shoring system.

Surcharge based on E80 Cooper Load =

$$q_s = \frac{\text{Axle Load}}{(\text{Axle Spacing})(\text{Track} + H1)} = \frac{80,000}{(5)(9 + 5)} = 1142.86 \text{ psf}$$

Axle Load: Maximum load per Railroad Axle in lbs. (See Cooper E80 Load Figure 8-4)

Axle Spacing: Minimum distance of spacing between Railroad Axles in feet. (See Cooper E80 Load Figure 8-4)

Track: Length of Railroad Tie in feet. (See problem statement)

H1: Height of backfill slope between bottom of tie and top of retaining system in feet. Per code the height of the backfill slope should be added to the track length when calculating the appropriate surcharge for the Boussinesq Load.

This surcharge is then transformed into a Boussinesq Load. Below shows a sample calculation to determine the Boussinesq Load at a depth of 5 ft:

$$\sigma_h = 2Q_s \frac{\beta_R - \sin \beta \cos 2\alpha}{\pi}$$

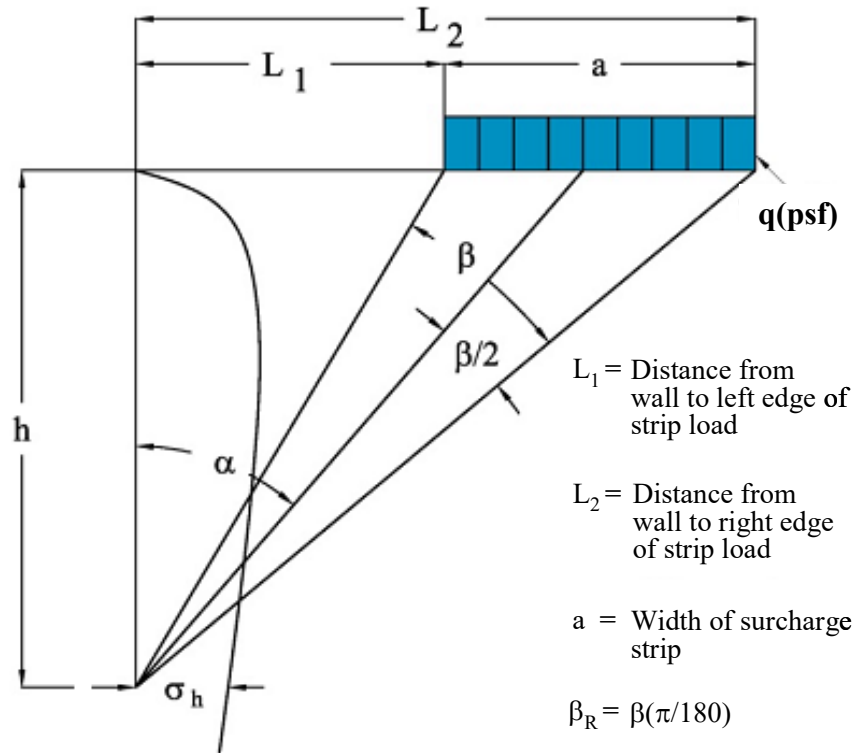

Figure 8-7. Boussinesq Type Strip Load for Railroad

$$q_s = 1,142.86 \text{ psf}$$

$$\beta = \sin^{-1}\left(\frac{L_2}{\sqrt{L_2^2 + h^2}}\right) - \sin^{-1}\left(\frac{L_1}{\sqrt{L_1^2 + h^2}}\right) = \sin^{-1}\left(\frac{22.5}{23.05}\right) - \sin^{-1}\left(\frac{13.5}{14.40}\right) = 7.79^\circ$$

$$\alpha = \sin^{-1}\left(\frac{L_1}{\sqrt{L_1^2 + h^2}}\right) + \frac{1}{2}\beta = \sin^{-1}\left(\frac{13.5}{14.40}\right) + \frac{1}{2}(7.79^\circ) = 73.57^\circ$$

$$\beta_R = \beta\left(\frac{\pi}{180}\right) = 7.79^\circ\left(\frac{\pi}{180}\right) = 0.14$$

$$\sigma_h = 2(1,142.86) \frac{0.14 - \sin(7.79^\circ)\cos(2 * 73.57^\circ)}{\pi} = 181.87 \approx 182 \text{ psf}$$

The above procedure is used to determine Boussinesq loads at specific intervals, keep in mind that for the upper 10 ft of the shoring system the minimum surcharge load is 72 psf. For the moment arms, each is assumed to be in the middle of the trapezoids. Table 8-2 below displays Boussinesq loads at various intervals below the top of temporary retaining system (not below the railroad tie):

RAILROADS

Table 8-2. Boussinesq loads at various depths

Depth (ft)	Load (psf)	Location
0	72	Top of shoring
5	182	
10	238	
15	208	
24	123	Dredge line
34	65*	Bottom of shoring

The General Pressure Diagram is shown below in Figure 8-8:

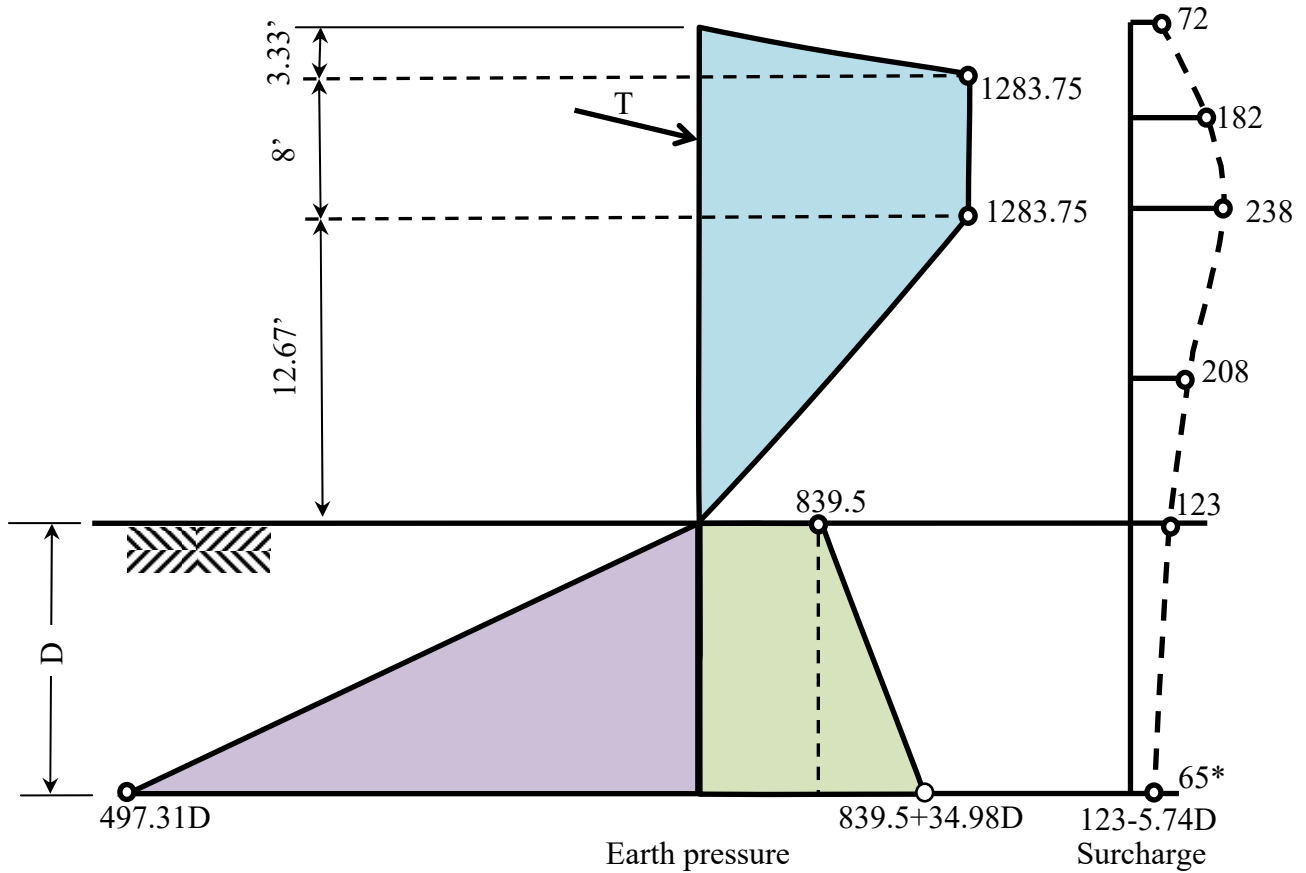

Figure 8-8. General Pressure Diagram

* The surcharge load of 65 psf is shown for illustrative purposes only. The actual load is dependent on depth, D, shown in the equation above.

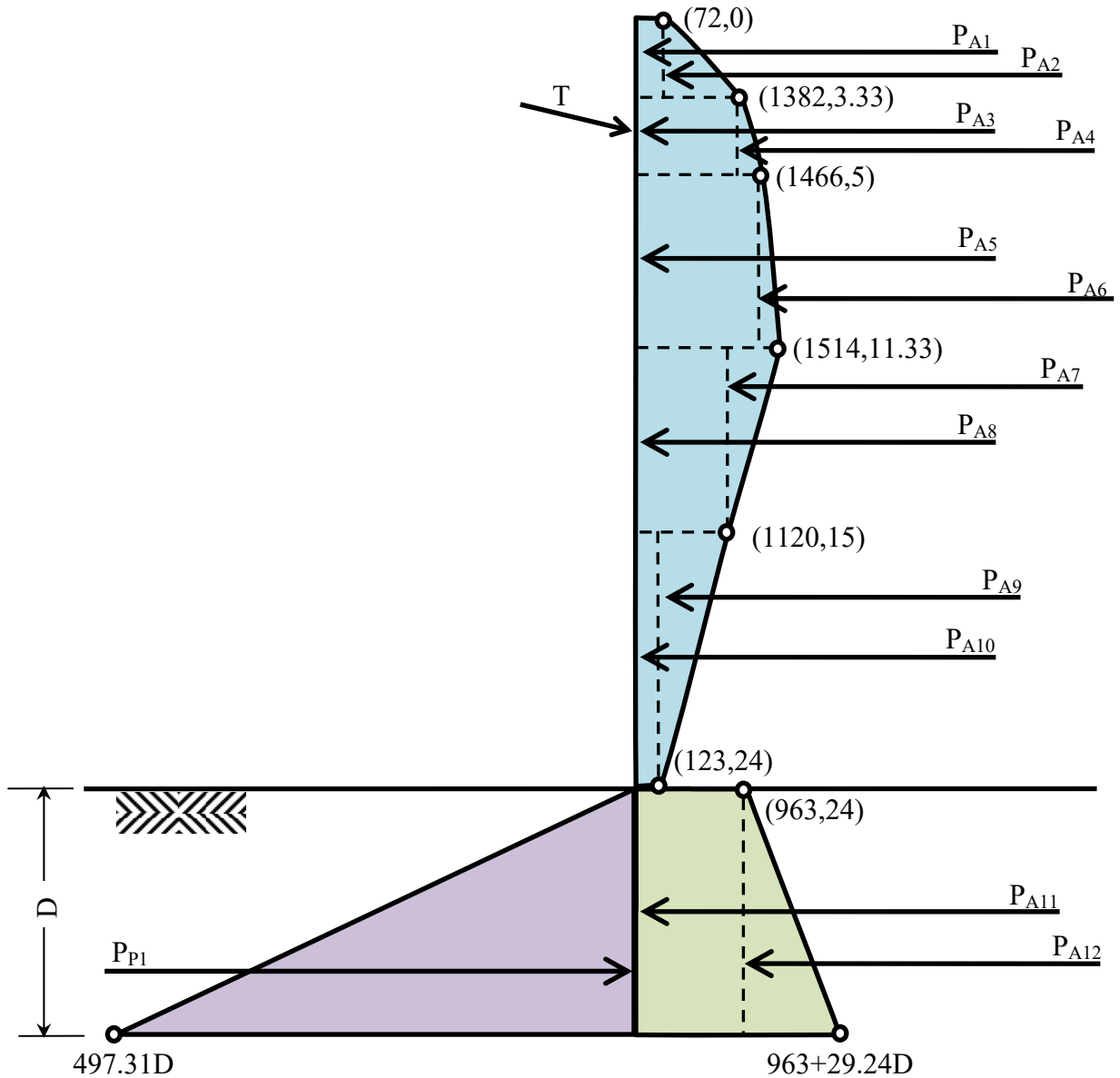

Figure 8-9. Combined Pressure Diagram (No Scale)

The loads coordinates from the Boussinesq load are added to the trapezoidal pressure diagram to calculate the total load acting on the shoring system as shown in Figure 8-9.

STEP II: Determine Depth, D

For Soldier piles an arching factor needs to be calculated and applied to both the Active and Passive forces below the dredge line only. Assume that the effective width of the piles is 1.27 ft.

$$\text{Arching Factor} = 0.08\phi = 0.08(27) = 2.16$$

RAILROADS

Calculating Driving and Resisting Moments taken about the Tieback Force:

Table 8-3. Calculated Driving and Resisting Moments

Driving Force (plf)	Arm (ft)	Driving Moment M_{DR} (lb)
$P_{A1} = (3.33)(72)(8) = 1,918.08$	$\frac{1}{2}(3.33) + 1.67 = 3.33$	-6,387.2
$P_{A2} = \frac{1}{2}(3.33)(1310)(8) = 17,449.2$	$\frac{1}{3}(3.33) + 1.67 = 2.78$	-48,508.8
$P_{A3} = (1.67)(1382)(8) = 18,463.52$	$\frac{1}{2}(1.67) = 0.84$	-15,509.4
$P_{A4} = \frac{1}{2}(1.67)(84)(8) = 561.12$	$\frac{1}{3}(1.67) = 0.56$	-314.2
$P_{A5} = (6.33)(1466)(8) = 74,238.2$	$\frac{1}{2}(6.33) = 3.16$	234,593
$P_{A6} = \frac{1}{2}(6.33)(48)(8) = 1,215.40$	$\frac{2}{3}(6.33) = 4.22$	5,128.8
$P_{A7} = \frac{1}{2}(3.67)(394)(8) = 5,783.9$	$6.33 + \frac{1}{3}(3.67) = 7.55$	43,668.6
$P_{A8} = (3.67)(1120)(8) = 32,883.2$	$6.33 + \frac{1}{2}(3.67) = 8.17$	268,656
$P_{A9} = \frac{1}{2}(9)(997)(8) = 35,892$	$10 + \frac{1}{3}(9) = 13$	466,596
$P_{A10} = (9)(123)(8) = 8,856$	$10 + \frac{1}{2}(9) = 14.5$	128,412
$P_{A11} = (963)(D)(1.27)(2.16) = 2,641.7 D$	$19 + \frac{1}{2}(D)$	$1,320.85 D^2 + 50,192.3 D$
$P_{A12} = \frac{1}{2}(29.24 D)(D)(1.27)(2.16) = 40.11 D^2$	$19 + \frac{2}{3}(D)$	$26.74 D^3 + 762.09 D^2$
Resisting Force (plf)	Arm (ft)	Resisting Moment M_{RS} (lb)
$P_{P1} = \frac{1}{2}(D)(497.31 D)(1.27)(2.16) = 682.11 D^2$	$19 + \frac{2}{3}(D)$	$454.74 D^3 + 12,960.09 D^2$

$$M_{DR} = 26.74 D^3 + 2,082.94 D^2 + 50,192.3 D + 1,076,334.5$$

$$M_{RS} = 454.74 D^3 + 12,960.09 D^2$$

Per AREMA, for restrained temporary shoring systems the minimum embedment length is 1.5 times the calculated depth. See Section 8.1.5.7. For equilibrium status ($FS = 1$), set the resisting moment equal to the driving moment as shown below and solve for D :

$$M_{RS} = M_{DR}$$

$$26.74 D^3 + 2,082.94 D^2 + 50,192.3 D + 1,076,334.5 = 454.74 D^3 + 12,960.1 D^2$$

$$428 D^3 + 10,877.16 D^2 - 50,192.3 D - 1,076,334.5 = 0$$

$$D^3 + 25.41 D^2 - 117.27 D - 2,514.8 = 0$$

$$D = 10.2 \text{ ft}$$

$$\text{Minimum required Depth, } D = 10.2 \text{ ft} * 1.5 = 15.3 \text{ ft}$$

STEP III: Calculate Tieback Load

Sum forces in the horizontal direction and set to zero:

$$\sum F_x = 0$$

$$\{T_H + 682.11(10.2)^2\} = \left\{ \begin{array}{l} 1,918.08 + 17,449.2 + 18,463.5 + 561.12 + 74,238.2 + 1,215.4 \\ + 5,783.9 + 32,883.2 + 35,892 + 8,856 + 2,641.7(10.2) + 40.11(10.2)^2 \end{array} \right\}$$

$$T_H = 228,379 - 70,967 = 157.41 \text{ Kips}$$

$$T = \frac{157.41}{\cos(15^\circ)} = 162.97 \text{ Kips (along } 15^\circ \text{ angle)}$$

Calculated Maximum Moment = 529.41 K-ft.

Calculated Maximum Shear = 119.02 Kips.

Graphical solution for determining maximum shear and moment for Railroad Problem EXAMPLE 8-1 follows. The graphical solution is necessary in this instance when calculating deflections. Note that in the following analysis, for simplicity, the active and passive loads in the embedded zone have been combined.

RAILROADS

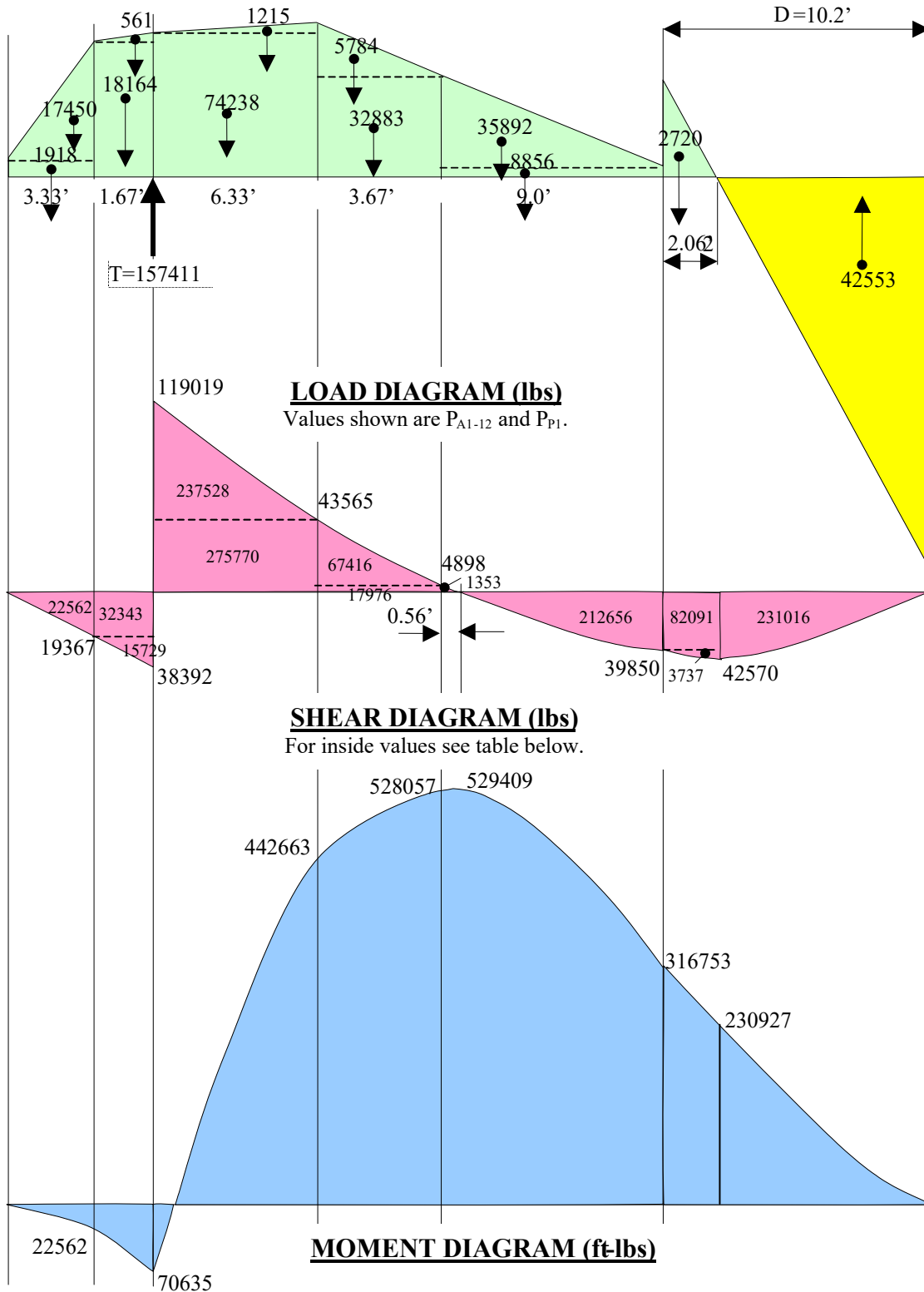

Figure 8-10. Final Load, Shear, and Moment Diagrams for EXAMPLE 8-1

CT TRENCHING AND SHORING MANUAL

NOTE: By geometry the point of zero shear was determined to be 10.56' below the tieback and F_{A9} and F_{A10} have been adjusted accordingly. The following table is provided to show how the various areas from the load and shear diagrams above were used to determine the values for the moment diagram.

Table 8-4. Determining Moment Diagram Values

<i>Area Under the Shear Diagram (sf)</i>	<i>Segment Area (sf)</i>	<i>Moment (ft-lbs)</i>
$F_{A1} = \frac{1}{2} (3.33)(1,918.08) = 3,193.6$	$3,193.6 + 19,368.6 = 22,562$	22,562
$F_{A2} = \frac{1}{3} (3.33)(17,449.2) = 19,368.6$		
$F_{A3} = \frac{1}{2} (1.67)(18,463.5) = 15,417.0$	$15,417.0 + 312.36 + 19,367(1.67) = 15,728.36 + 32,343 = 48,073$	$22,562 + 48,073 = 70,635$
$F_{A4} = \frac{1}{3} (1.67)(561.12) = 312.36$		
$F_{A5} = \frac{1}{2} (6.33)(74,238.2) = 234,964.0$	$234,964.0 + 2,564.41 + 6.33(43,565.5) = 237,528 + 275,770 = 513,298$	$-70,635 + 513,298 = 442,663$
$F_{A6} = \frac{1}{3} (6.33)(1,215.36) = 2,564.41$		
$F_{A7} = \frac{1}{3} (3.67)(5,783.92) = 7,075.66$	$7,075.66 + 60,340.67 + 3.67(4898.36) = 67,416.33 + 17,976.98 = 85,393$	$442,663 + 85,393 = 528,056$
$F_{A8} = \frac{1}{2} (3.67)(32,883.2) = 60,340.67$		
$F_{A9a} = (0.56)(1,058.0)(8) = 4,739.84$ $F_{A9a} = \frac{1}{2} (0.56)(4,739.84) = 1,327.16$	$1,327.16 + 25.92 = 1,353$	$528,056 + 1,353 = 529,409$
$F_{A10a} = \frac{1}{2} (0.56)(1,120 - 1,058.0)(8) = 138.88$ $F_{A10a} = \frac{1}{3} (0.56)(138.88) = 25.92$		
$F_{A9b} = \frac{1}{2} (8.44)(1,058.0 - 123)(8) = 31,565.6$ $F_{A9b} = \frac{2}{3} (8.44)(31,565.6) = 177,609.11$		
$F_{A10b} = (8.44)(123)(8) = 8,304.96$ $F_{A10b} = \frac{1}{2} (8.44)(8,304.96) = 35,046.93$		
Areas Below Excavation		
$F_{A11a} = \frac{2}{3} (2.06)(2,720.95) = 3,736.77$	$3,736.77 + 2.06(39,849.64) = 3,736.77 + 82,090.26 = 85,827$	$316,753 - 85,827 = 230,926$
$F_{P1a} = \frac{2}{3} (8.14)(42,570.59) = 231,016$		$230,926 - 231,016 = -90$

RAILROADS

Determine lagging needs:

By inspection, the maximum load on the lagging is 1,521 psf acting 10 ft below the top of the shoring system (see Figure 8-8). Per CHAPTER 5, maximum lagging load may be limited to 400 psf without surcharges and assume that the design load on the lagging may taken as 0.6 times the calculated pressure based on a simple span. In this example the Railroad surcharge voids the 400 psf limitation. Also, the Railroad nullifies the use of the 1.33 load duration factor as discussed in CHAPTER 5. Therefore:

$$M_{\max} = \frac{wL^2}{8} = \frac{(1,521)(8')^2}{8} = 12,168 \text{ ft} \cdot \text{lb}$$

$$S \text{ Required} = \frac{M_{\max} * 12 * 0.6}{F_b} = \frac{12,168 \text{ ft} \cdot \text{lb} * 12 \text{ in/ft} * 0.6}{1,500 \text{ psi}} = 58.41 \text{ in}^3$$

Use 6 x 12' s (rough lumber): $S = 72 \text{ in}^3$ (Note that no lagging size was specified in the example problem statement)

Note that if the 400 psf limitation had been used, the required S would have been 15.36 in^3 and the minimum required rough lumber size would have been 3 x 12.

Check shear in the lagging at distance d from the face of support:

$$V = \left(\frac{L}{2} - d \right) (w)(0.6) = \left(\frac{8'}{2} - \frac{4''}{12} \right) (1,521)(0.6) = 3,349 \text{ lb}$$

$$f_v = \frac{3V}{2A} = \frac{3(3,349)}{2(6'')(12'')} = 69.8 \text{ psi} < 140 \text{ psi} \quad \therefore \text{OK}$$

In the above example, the actual pile spacing was used as the span length for the lagging. However, if further refinement is necessary, the span length could to taken as the clear distance between supports plus half the required bearing length at each support. For 12" high lagging with the required bearing length of a , the revised span length would be:

$$\frac{\left(\frac{wL}{2} \right)}{a * 12} = 450 \text{ psi}$$

$$a = \frac{wL}{2(12)(450)} = \frac{(1,521)(8)}{10,800} = 1.13 \text{ in}$$

$$\text{Span Length } L = 8' - \frac{12''}{12} + \frac{1.13''}{12} = 7.09 \text{ ft}$$

CT TRENCHING AND SHORING MANUAL

A common substitute for wood lagging is a steel plate. The analysis for steel plate lagging is similar to that shown above for wood lagging:

$$F_b = 36,000 \text{ psi} * 0.75 = 27,000 \text{ psi}$$

$$M_{\max} = \frac{wL^2}{8} = \frac{(1,521)(8')^2}{8} = 12,168 \text{ ft} \cdot \text{lb}$$

$$S \text{ Required} = \frac{M_{\max} * 12 * 0.6}{F_b} = \frac{12,168 \text{ ft} \cdot \text{lb} * 12 \text{ in/ft} * 0.6}{27,000 \text{ psi}} = 3.25 \text{ in}^3$$

$$\text{Required plate thickness} = \sqrt{\frac{(6)(3.25)}{12}} = 1.275 \text{ in}$$

By inspection shear for steel lagging is OK.

8.3 DEFLECTION CALCULATION

Horizontal movement, or deflection, of shoring systems as described in CHAPTER 6 and CHAPTER 7 of this Manual can only be roughly approximated because soils do not apply pressures as true equivalent fluid, even in the totally active state. A deflection calculation can be made by structural mechanics procedures (moment area – M/EI) and then some engineering judgment should be used. Soil type, stage construction and the time that the shoring is in place will affect the movement. Monitoring or performance testing is important also.

The following is an example of a deflection calculation for EXAMPLE 8-1, a soldier pile with a single tieback. It is assumed that the lock-off load of the tieback is sufficient to preclude any movement at the tieback support. Additionally, the Point of Fixity of the pile will be assumed at 0.25D below the excavation line. For simplicity, the point of maximum deflection is assumed to occur at the location of maximum moment. The moment-area method will be used to calculate the deflections.

Determine the depth to the Point of Fixity (PoF) below excavation line.

$$\text{PoF} = (0.25)(D) = (0.25)(10.2') = 2.55'$$

Determine the deflection δ_p as shown in Figure 8-11.

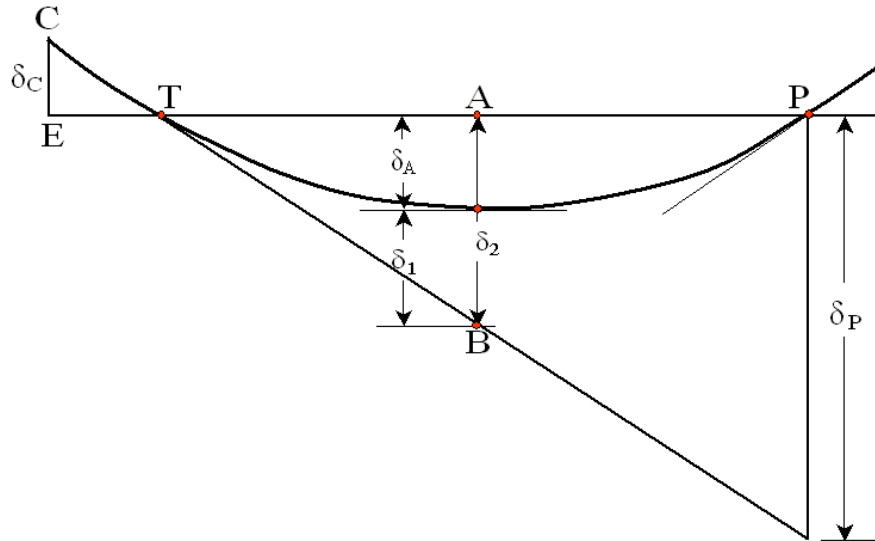

Figure 8-11. Deflected Shape of Shoring System

$$\delta_2 = (\delta_p) \left(\frac{10.56'}{21.55'} \right)$$

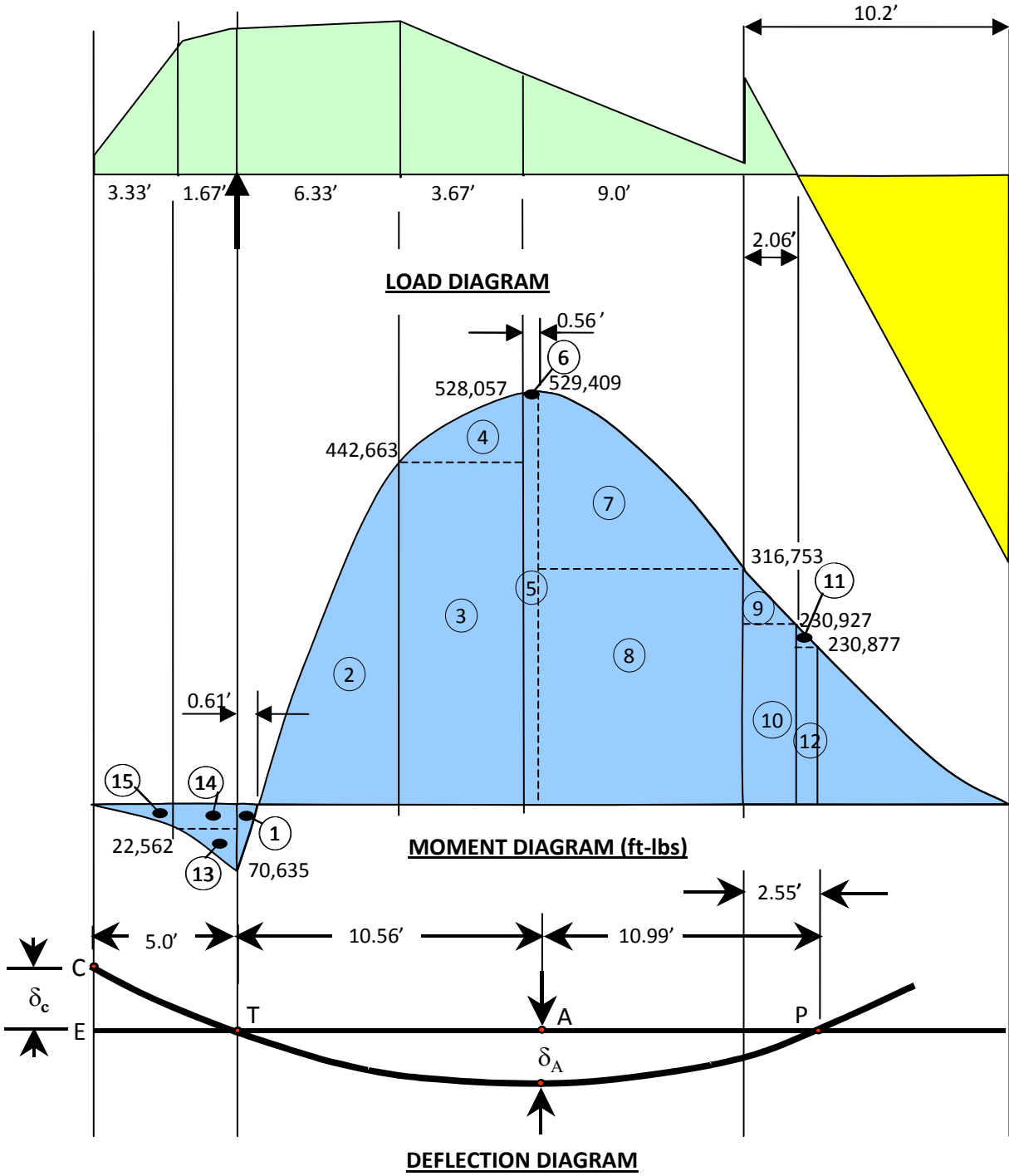

Figure 8-12. Schematic of Load, Moment and Deflection Diagrams for EXAMPLE 8-1

RAILROADS

Determine the deflection tangent to the elastic curve at the point of assumed maximum deflection from the tangent at T (δ_1).

The true deflection at A: $\delta_A = \delta_2 - \delta_1$. For the following calculations see Figure 8-12, Schematic of Load, Moment and Deflection Diagrams for EXAMPLE 8-1 for additional details. The moments below are taken about point P, the PoF.

Table 8-5. Calculations for deflection δ_p

Loc	Area (lb-ft ²)	Moment Arm (ft)	Area Moment (lb-ft ³)
①	$-\frac{1}{4}(70,635)(0.61')$	$20.94' + \frac{4}{5}(0.61')$	-230,818
②	$\frac{3}{4}(442,663)(5.72')$	$15.22' + \frac{2}{5}(5.72')$	33,248,113
③	$(442,663)(3.67')$	$11.55' + \frac{1}{2}(3.67')$	21,744,910
④	$\frac{3}{4}(528,057 - 442,663)(3.67')$	$11.55' + \frac{2}{5}(3.67')$	3,059,817
⑤	$(528,057)(0.56')$	$10.99' + \frac{1}{2}(0.56')$	3,332,673
⑥	$\frac{3}{4}(529,409 - 528,057)(0.56')$	$10.99' + \frac{2}{5}(0.56')$	6,373
⑦	$\frac{3}{4}(529,409 - 316,753)(8.44')$	$2.55' + \frac{3}{5}(8.44')$	10,249,302
⑧	$(316,753)(8.44')$	$2.55' + \frac{1}{2}(8.44')$	18,098,904
⑨	$\frac{1}{4}(316,753 - 230,927)(2.06')$	$0.49' + \frac{3}{5}(2.06')$	76,291
⑩	$(230,927)(2.06')$	$0.49' + \frac{1}{2}(2.06')$	723,076
⑪	$\frac{1}{4}(230,927 - 230,877)(0.49')$	$\frac{3}{5}(0.49')$	2
⑫	$(230,877)(0.49')$	$\frac{1}{2}(0.49')$	27,717
Total			90,336,356

$$\delta_p = 90,336,356 \left(\frac{1728}{180 * 10^9} \right) = 0.867''$$

$$\delta_2 = 0.867'' \left(\frac{10.56'}{21.55'} \right) = 0.426'' \approx 0.43''$$

To determine δ_A calculate δ_I by taking moments about point A.

Table 8-6. Calculations for deflection δ_I

Loc	Area (lb-ft ²)	Moment Arm (ft)	Area Moment (lb-ft ³)
①	$-\frac{1}{4}(70,635)(0.61')$	$9.95' + \frac{4}{5}(0.61')$	-112,436
②	$\frac{3}{4}(442,663)(5.72')$	$4.23' + \frac{2}{5}(5.72')$	12,377,839
③	$(442,663)(3.67')$	$0.56' + \frac{1}{2}(3.67')$	3,890,852
④	$\frac{3}{4}(528,057 - 442,663)(3.67')$	$0.56' + \frac{2}{5}(3.67')$	476,671
⑤	$(528,057)(0.56')$	$\frac{1}{2}(0.56')$	82,799
⑥	$\frac{3}{4}(529,409 - 528,057)(0.56')$	$\frac{2}{5}(0.56')$	127
Total			16,715,853

$$\delta_1 = 16,715,853 \left(\frac{1728}{180 * 10^9} \right) = 0.16''$$

$$\delta_A = \delta_2 - \delta_1 = 0.43'' - 0.16'' = 0.27''$$

Determine the deflection δ_C as shown in Figure 8-13.

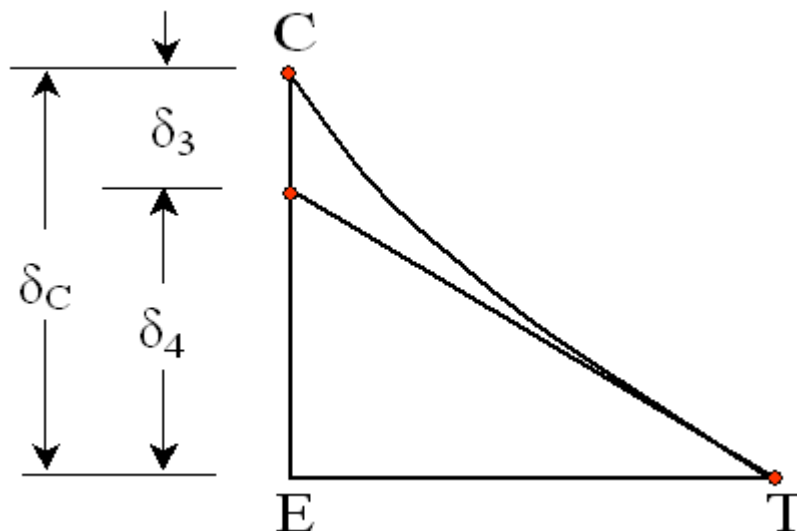

Figure 8-13. Deflected Shape of Shoring System above the Tieback

RAILROADS

$$\delta_C = \delta_3 + \delta_4$$

$$\delta_4 = 0.867'' \left(\frac{5'}{21.55'} \right) = 0.201'' \approx 0.20''$$

Determine δ_3 by taking moments about point E.

Table 8-7. Calculations for deflection δ_3

Loc	Area (lb-ft ²)	Moment Arm (ft)	Area Moment (lb-ft ³)
⑬	$-\frac{1}{4}(70,635 - 22,562)(1.67')$	$3.33 + \frac{4}{5}(1.67')$	-93,648
⑭	$-(22,562)(1.67')$	$3.33 + \frac{1}{2}(1.67')$	-156,933
⑮	$-\frac{1}{4}(22,562)(3.33')$	$\frac{4}{5}(3.33')$	-50,038
Total			-300,619

$$\delta_3 = -300,619 \left(\frac{1728}{180 * 10^9} \right) = -0.0028'' \approx 0.00''$$

$$\delta_C = \delta_3 + \delta_4 = 0.00'' + 0.20'' = 0.20''$$

The final deflection shape of the shoring system using the moment area-M/EI method is shown in Figure 8-14. It is noted that the deflection shown here is only for the vertical element of the shoring system. Deflection of other elements including any lagging must also be considered when determining the maximum deflection on a shoring system.

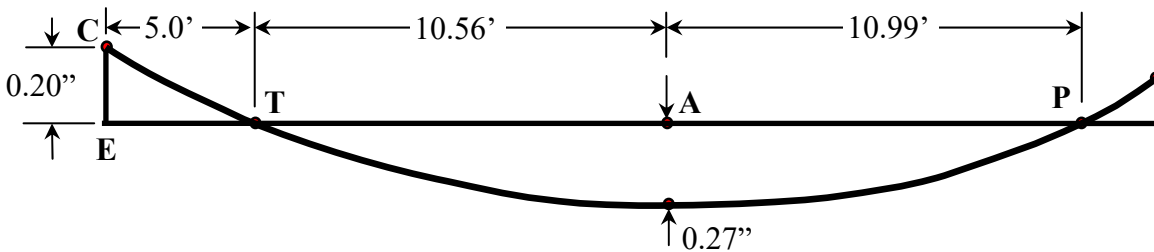

Figure 8-14. Final Deflected Shape of Shoring System

CT TRENCHING AND SHORING MANUAL

Caltrans Trenching and Shoring Check Program (CT-TSP), for EXAMPLE 8-1 (Railroad Example)

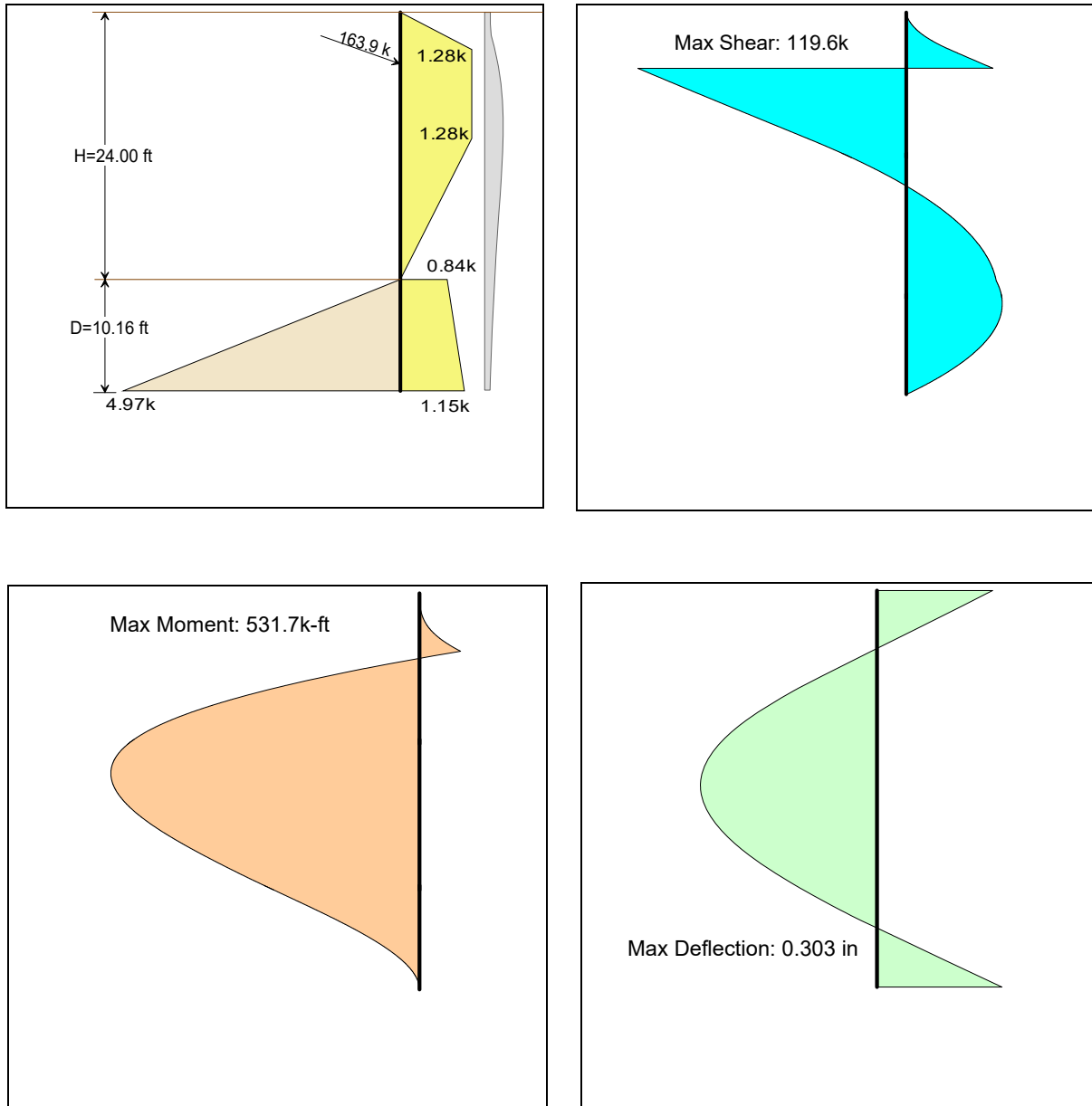
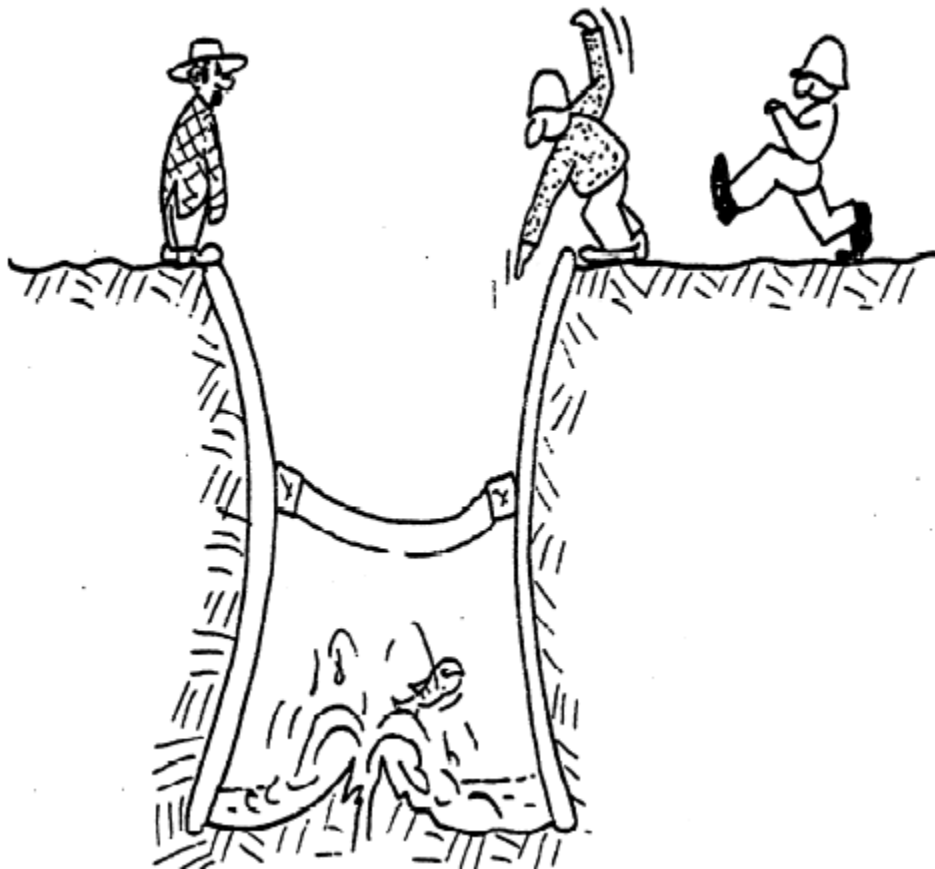

Figure 8-15. Diagrams per CT-TSP

CHAPTER 9

CONSTRUCTION AND SPECIAL CONSIDERATIONS



9.0 SPECIAL CONDITIONS

The best shoring system in the world is of little value if the soil being supported does not act as contemplated by the designer. Adverse soil properties and changing conditions need to be considered.

Anchors placed within a soil failure wedge will exhibit little holding value when soil movement in the active zone occurs. The same reasoning holds true for the anchors or piles in soils that decrease bonding or shear resistance due to changes in plasticity or cohesion. Additional information regarding anchors may be found in the USS Steel Sheet Piling Design Manual.

When cohesive soils tend to expand or are pushed upward in an excavation, additional forces are exerted on the shoring system, which may induce lateral movement of the shoring system. Soil rising in an excavation indicates that somewhere else soil is settling. Water rising in an excavation can lead to quick conditions, while water moving horizontally can transport soil particles leaving unwanted voids at possibly critical locations.

A very important issue to consider that is present in most types of shoring systems is the potential for a sudden failure sudden failure due to slippage of the soil around the shoring system along a surface offering the least amount of resistance.

Sample situations of the above are included on the following pages.

9.1 ANCHOR BLOCK

The lateral support for sheet pile and/or soldier pile walls can be provided by tie rods that extend to a concrete anchor block (deadman) or a continuous wall as shown in Figure 9-1. Tie rod spacing is a function of wall height, wall backfill properties and the soil-foundation properties below the dredge line, structural properties of the wall and the anchor block.

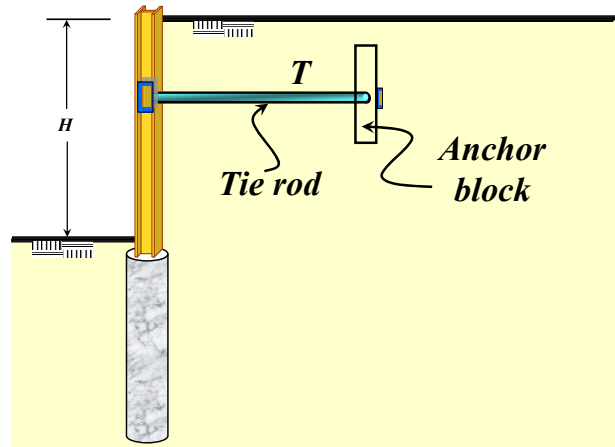

Figure 9-1. Anchor Block and Tie Rod

The size, shape, depth and location of an anchor block affect the resistance capacity developed by that anchor. Figure 9-2 explains how the distance from the wall affects capacity

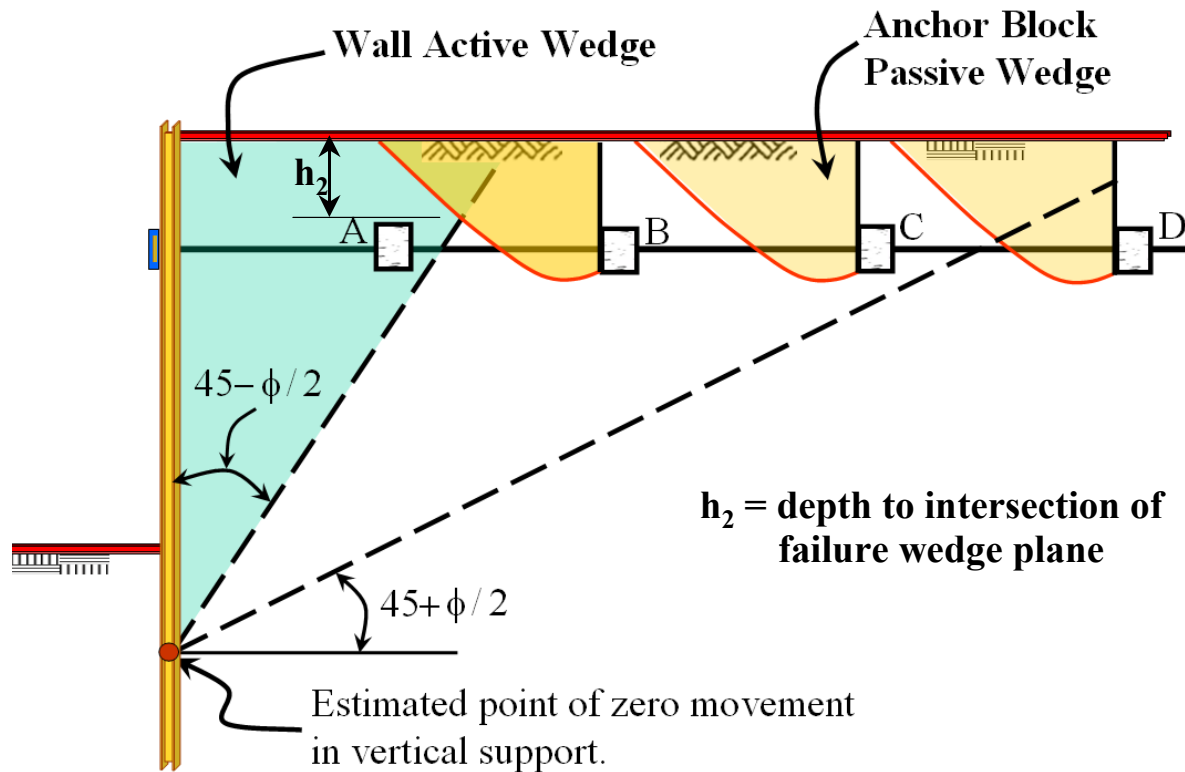

Figure 9-2. Anchor block

Anchor block A is located inside active wedge and offers no resistance.

Anchor block B resistance is reduced due to overlap of the active wedge (wall) and the passive wedge (anchor).

Anchor reduction: (Granular soils)

$$\Delta P_p = \frac{\gamma h_2^2 (K_p - K_a)}{2} \quad \text{Eq. 9-1}$$

ΔP_p is transferred to the wall.

Anchor block C develops full capacity but increases pressure on wall.

Anchor block D develops full capacity and has no effect on bulkhead.

Anchor blocks should be placed against firm natural soil and should not be allowed to settle.

A safety factor of 2 is recommended for all anchors and anchor blocks.

The following criteria are for anchors or anchor blocks located entirely in the passive zone as indicated by Anchor D.

9.1.1 Anchor Block in Cohesionless Soil

Case A – Anchor block extends to the ground surface

The forces acting on an anchor near the ground surface is shown in Figure 9-3.

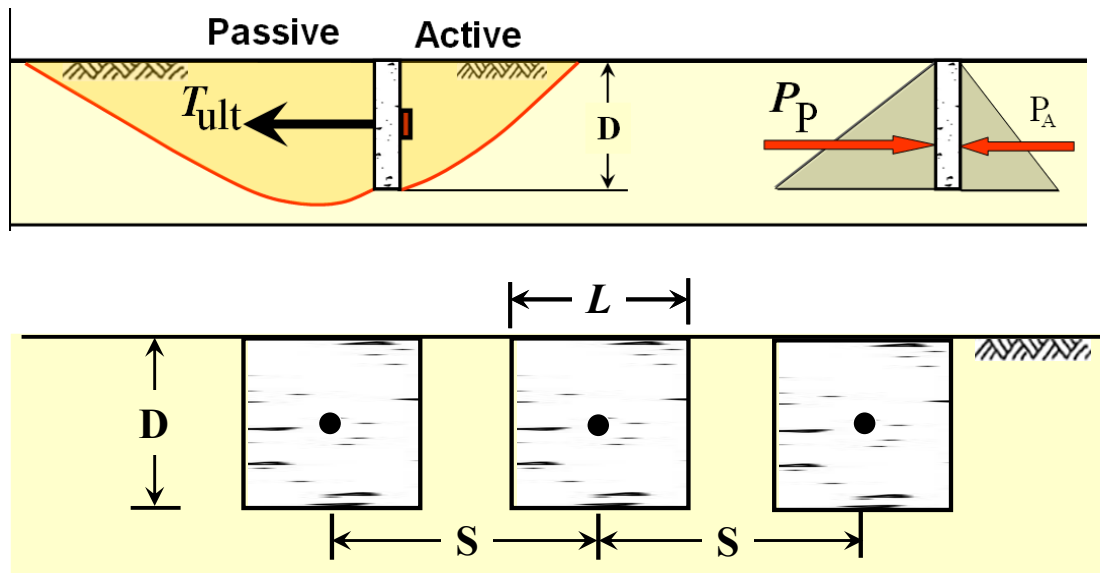

Figure 9-3. Anchor block in cohesionless soil near ground surface

The capacity of an anchor block also depends on whether it is continuous or isolated. An anchor block is considered continuous when its length greatly exceeds its height. The conventional earth pressure theories using two-dimensional conditions corresponding to a long wall can be used to calculate the resistance force against the anchor block movement.

The basic equation for a continuous anchor block is shown below:

$$T_{ult} = L(P_p - P_a) \quad \text{Eq. 9-2}$$

Where:

$$P_a = K_a \gamma \frac{D^2}{2} \quad \text{Eq. 9-3}$$

$$P_p = K_p \gamma \frac{D^2}{2} \quad \text{Eq. 9-4}$$

Substituting Eq. 9-3 and Eq. 9-4 into Eq. 9-2 then:

$$T_{ult} = \gamma D^2 \Delta K \frac{L}{2} \quad \text{Eq. 9-5}$$

$$\Delta K = (K_p - K_a) \quad \text{Eq. 9-6}$$

L = Length of the anchor block.

In case of isolated and short anchor blocks a large passive pressure may develop because of three-dimensional effects due to a wider passive zone in front of the anchor block as shown below.

CONSTRUCTION AND SPECIAL CONSIDERATIONS

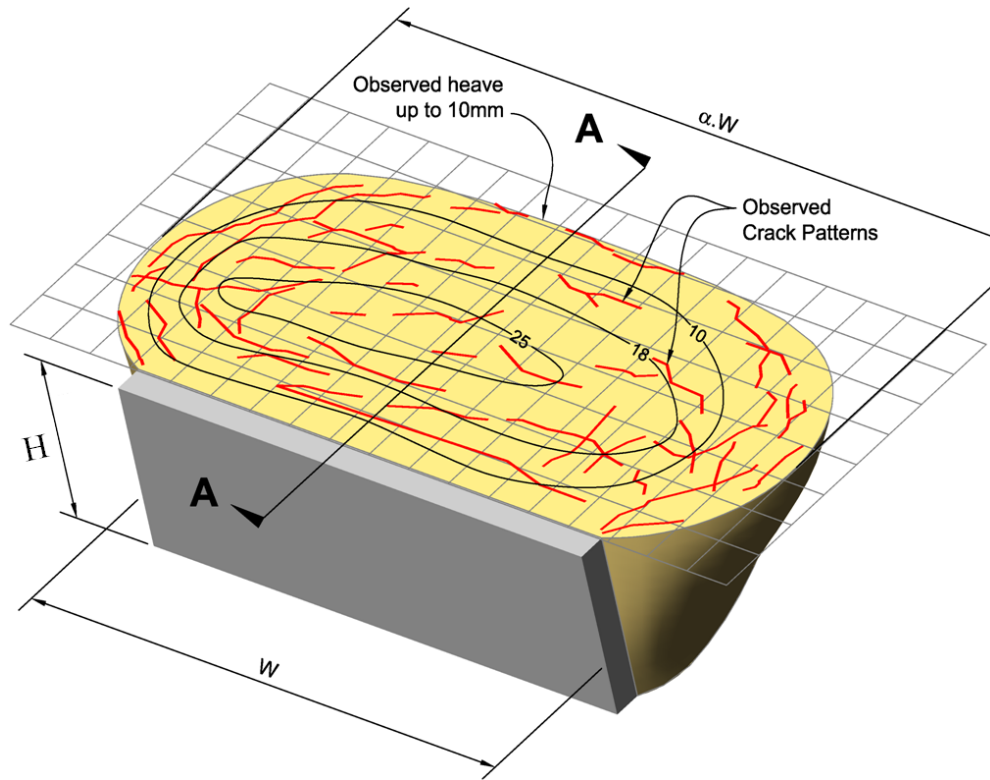

Figure 9-4. Anchor block in 3D (Shamsabadi, A., Nordal, S. (2006))



Figure 9-5. Section A-A (Shamsabadi, A., *et al.*, 2007).

The ratio between three-dimensional and two-dimensional soil resistance varies with the soil friction angle and the depth below the ground surface. Ovesen's theory can be used to estimate the magnitude of the three-dimensional effects as shown below.

$$T_{ult} = R \left[\gamma D^2 \Delta K \frac{L}{2} \right] \quad \text{Eq. 9-7}$$

Where,

$$R = 1 + \Delta K^{2/3} \left[1.1E^4 + \frac{1.6B}{1 + 5\frac{L}{D}} + \frac{0.4\Delta KE^3 B^2}{1 + 0.05\frac{L}{D}} \right] \quad \text{Eq. 9-8}$$

$$B = 1 - \frac{L}{S} \quad \text{Eq. 9-9}$$

$$E = 1 - \frac{H}{d + H} \quad \text{Eq. 9-10}$$

Case B – Anchor block does not extend to the ground surface.

The forces acting on an anchor, which is not near the ground surface is shown in Figure 9-6.

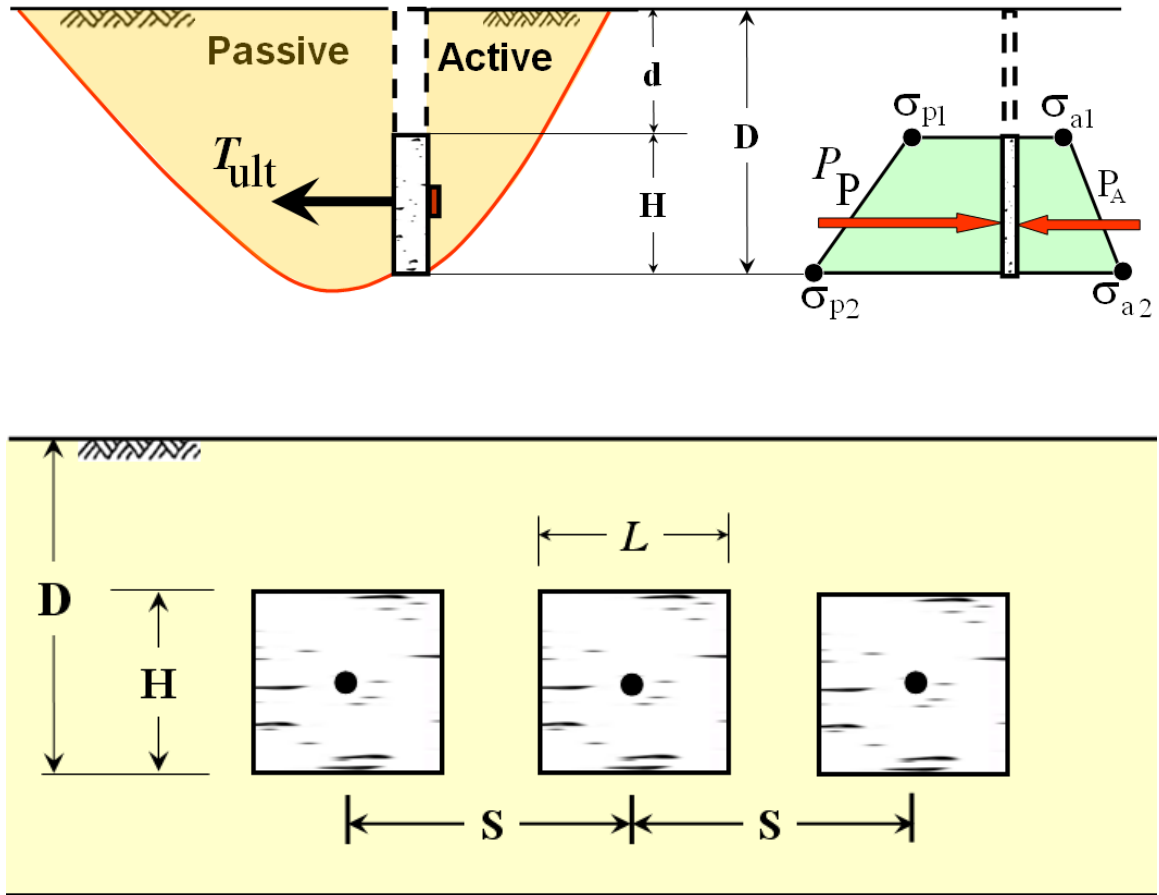

Figure 9-6. Anchor block not near the ground surface

The basic equation to calculate the capacity of a continuous anchor block with length L , not extended near the ground surface is shown Eq. 9-2.

$$T_{ult} = L(P_P - P_A)$$

Where the P_A and P_P are the areas of active and passive earth pressure developed in the front and back of the anchor block as shown in Figure 9-6 and Eq. 9-13 and Eq. 9-16.

$$\sigma_{a1} = \gamma d k_a \tag{Eq. 9-11}$$

$$\sigma_{a2} = \gamma D k_a \tag{Eq. 9-12}$$

$$P_A = \left[\frac{\sigma_{a1} + \sigma_{a2}}{2} \right] H \quad \text{Eq. 9-13}$$

$$\sigma_{p1} = \gamma d k_p \quad \text{Eq. 9-14}$$

$$\sigma_{p2} = \gamma D k_p \quad \text{Eq. 9-15}$$

$$P_p = \left[\frac{\sigma_{p1} + \sigma_{p2}}{2} \right] H \quad \text{Eq. 9-16}$$

L = Length of the anchor block

In case of isolated and short anchor blocks the Ovesen's three-dimensional factor (R) shall be estimated using Eq. 9-17.

$$R = 1 + \Delta K^{2/3} \left[1.1E^4 + \frac{1.6B}{1 + 5\frac{L}{D}} + \frac{0.4\Delta KE^3 B^2}{1 + 0.05\frac{L}{D}} \right] \quad \text{Eq. 9-17}$$

$$B = 1 - \frac{L}{S}$$

$$E = 1 - \frac{H}{d + H}$$

9.1.2 Anchor Block in Cohesionless Soil where $1.5 \leq D/H \leq 5.5$

The chart shown in Figure 9-7 is based on sand of medium density, ($\phi = 32.5$). For other values of ϕ , a linear correlation may be made from $(\phi/32.5)$. The chart is valid for ratios of depth to height of anchor (D/H) between 1.5 and 5.5.

For square anchor blocks the value from the chart (K_p') is larger than the value for continuous anchor blocks (K_p). This is because the failure surface is larger than the actual dimensions of the anchor block. In testing it is determined to be approximately twice the width.

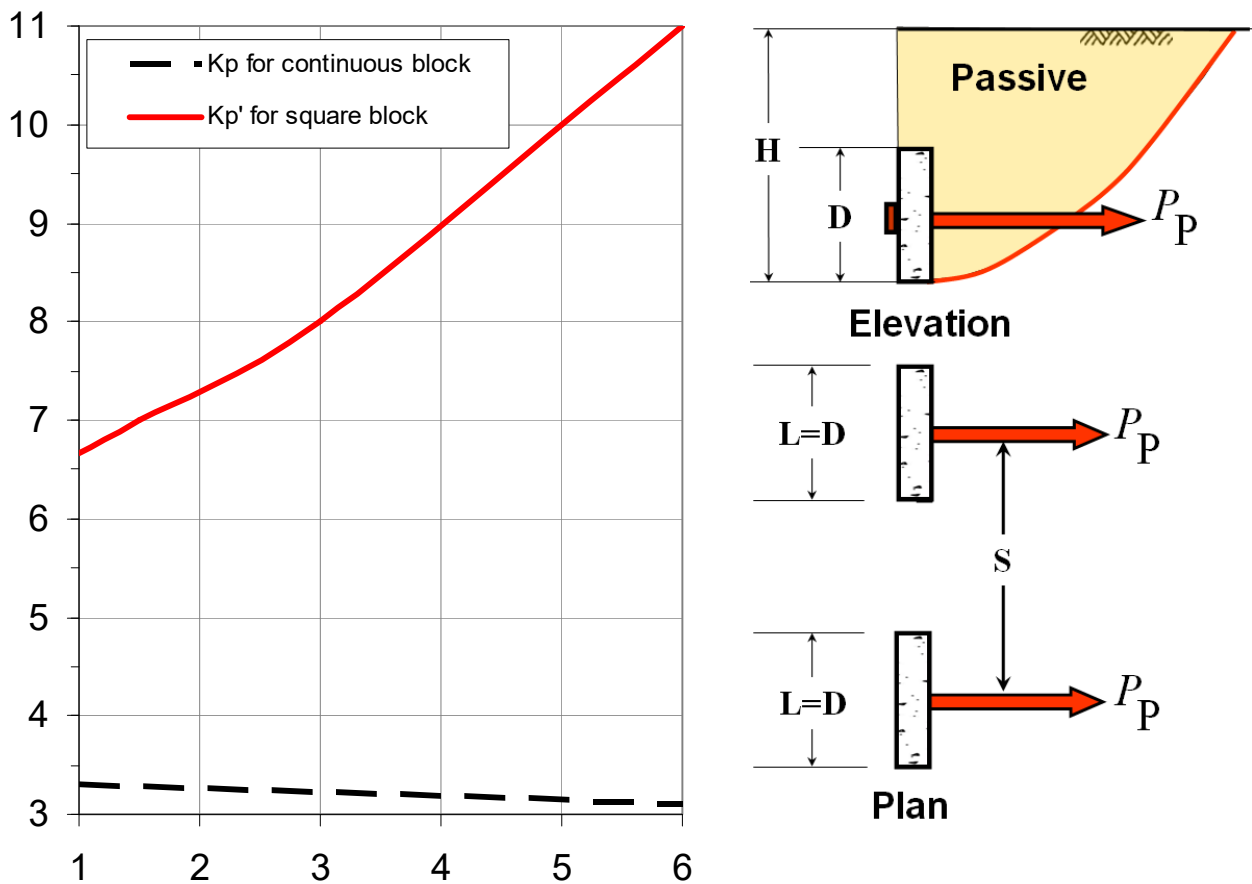

Figure 9-7. Anchor block in cohesionless soil $1.5 \leq D/H \leq 5.5$

For continuous anchor blocks:

Use Ovesen's equations to estimate the magnitude of the three-dimensional factor (R) as shown above.

For square (or short) anchor blocks where $D = L$.

$$P_{ult} = \frac{\gamma H^2 K_p' L}{2} \quad \text{Eq. 9-18}$$

It is recommended that a minimum factor of safety of 2 be used.

9.1.3 Anchor Block in Cohesive Soil near the Ground Surface $D \leq H/2$

The forces acting on an anchor are shown in the Figure 9-8. For this case, $D \leq H/2$ (Figure 9-6) where H is the height of the block, it is assumed that the anchor extends to the ground surface. Capacity of the anchor depends upon whether it is considered continuous or short.

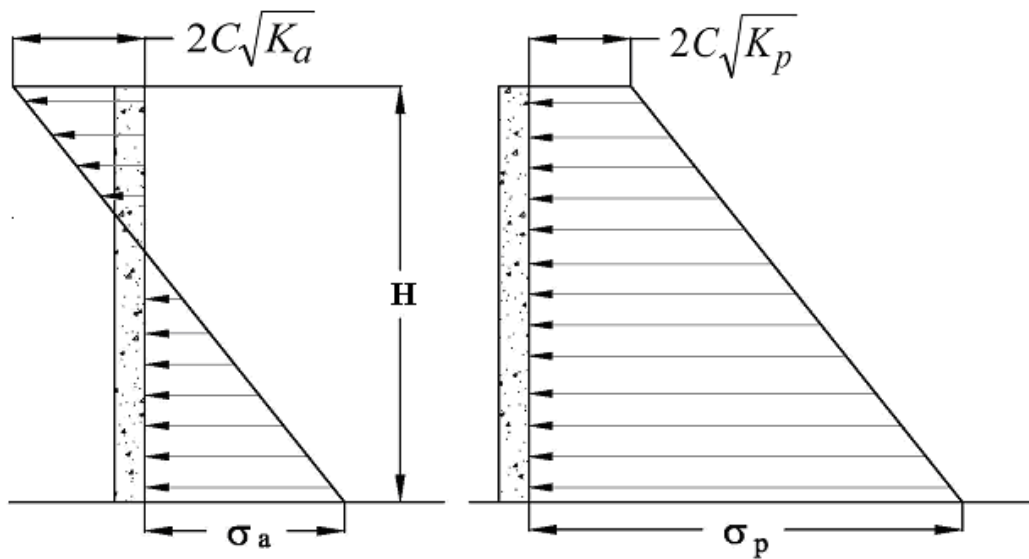

Figure 9-8. Anchor block in cohesive soil near ground $D \leq H/2$

Where:

$$\sigma_p = \gamma D K_p + 2C\sqrt{K_p} \quad \text{Eq. 9-19}$$

$$\sigma_a = \gamma D K_a - 2C\sqrt{K_a} \quad \text{Eq. 9-20}$$

CONSTRUCTION AND SPECIAL CONSIDERATIONS

The pressure diagram for cohesive soils assumes short load duration. For duration of a period of years it is likely that creep will change the pressure diagram. Therefore, conservative assumptions should be used in the analysis, such as $c = 0$ and $\phi = 27^\circ$.

The basic equation is:

$$T_{ult} = L(P_p - P_a) \quad \text{Eq. 9-21}$$

Where L = Length of anchor block.

For continuous anchor blocks:

$$P_p = \frac{\gamma D^2 K_p}{2} + 2CD\sqrt{K_p} \quad \text{Eq. 9-22}$$

$$P_a = \frac{(\gamma DK_a - 2C\sqrt{K_a})\left(D - \frac{2C}{\gamma}\right)}{2} \quad \text{Eq. 9-23}$$

It is recommended that the tension zone be neglected.

For short anchor blocks where $D = L$:

$$T_{ult} = L(P_p - P_a) + 2CD^2 \quad \text{Eq. 9-24}$$

9.1.4 Anchor Blocks in Cohesive Soil where $D \geq H/2$

The chart shown in Figure 9-9 was developed through testing for anchor blocks other than near the surface. The chart relates a dimensionless coefficient (R) to the ratios of depth to height of an anchor (D/H) to determine the capacity of the anchor block. The chart applies to continuous anchors only.

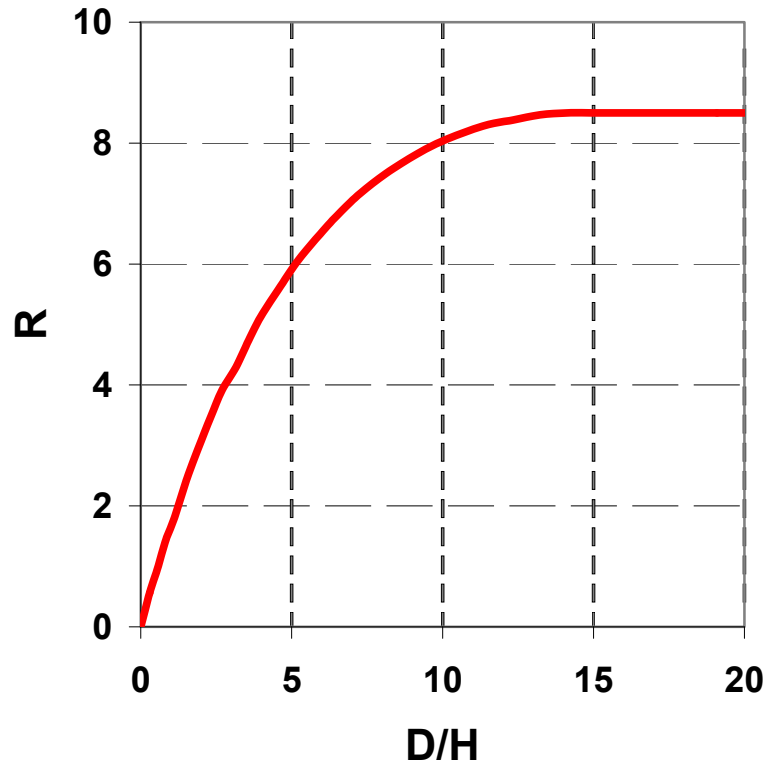

Figure 9-9. Anchor block in cohesive soil $D \geq H/2$

The above graph is from Strength of Deadmen Anchors in Clay, Thomas R. Mackenzie, Master's Thesis Princeton University, Princeton, New Jersey, 1955.

$$P_{ult} = RCHL \text{ with a maximum value of } R = 8.5.$$

It is recommended that a minimum factor of safety of 2 be used.

9.1.4.1 Example 9-1 Problem – Anchor Blocks

Given:

Check the adequacy of contractor's proposed shoring system shown in Figure 9-10. The 2x2 anchor blocks are to be buried 3' below the ground surface. The required tie load on the wall is 11,000 lbs.

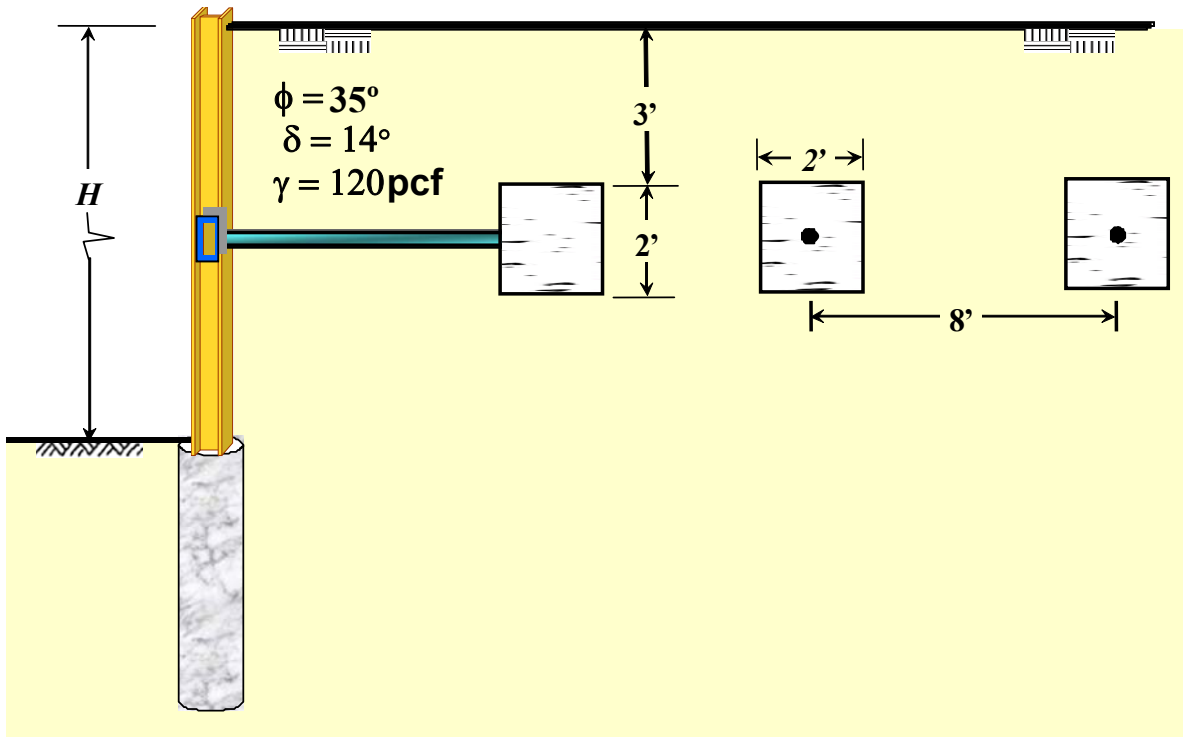

Figure 9-10. Anchor block Example 9-1

Solution:

Step 1: Calculate active and passive earth pressure in the front and back of the anchor block shown in Figure 9-11.

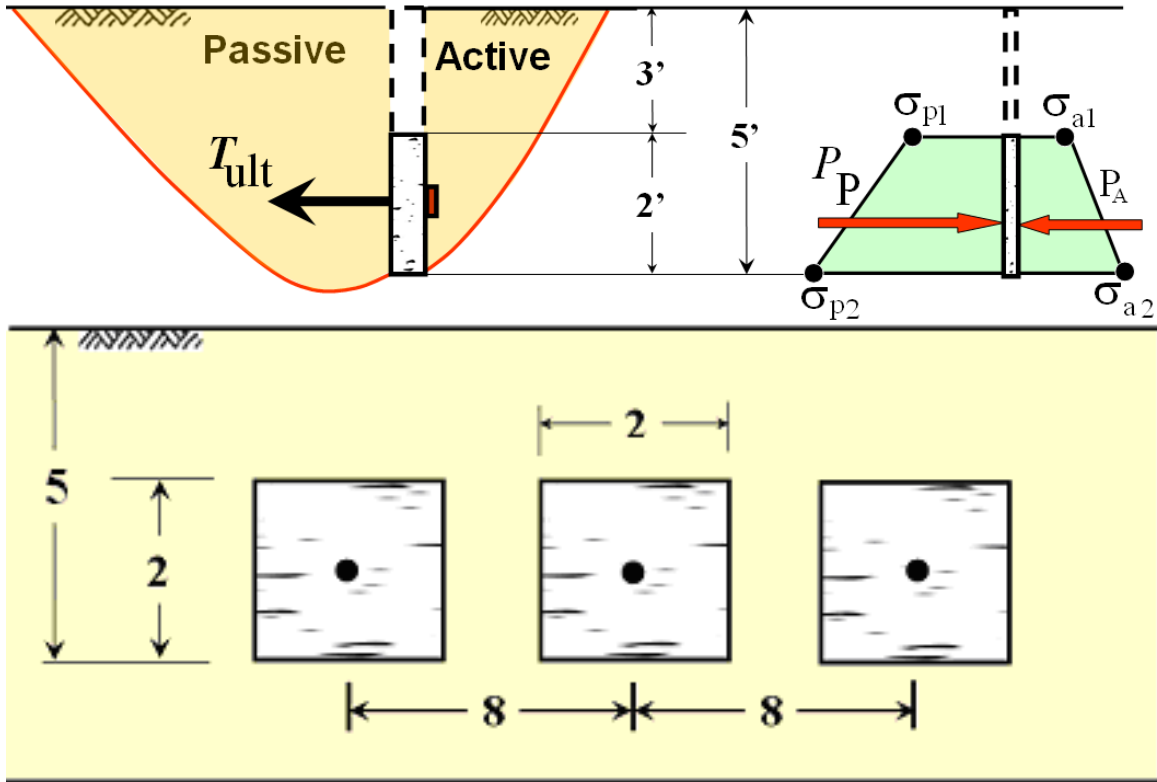

Figure 9-11. Anchor block Example 9-1 solution

$$K_p = 6.27$$

$$K_a = 0.27$$

$$\sigma_{a1} = \gamma dk_a * \cos(\delta) = 120 * 3 * 0.27 * \cos(14^\circ) = 94.31$$

$$\sigma_{a2} = \gamma Hk_a * \cos(\delta) = 120 * 5 * 0.27 * \cos(14^\circ) = 157.19$$

$$P_A = \left[\frac{94.31 + 157.19}{2} \right] 2 = 251.50$$

$$\sigma_{p1} = \gamma dk_p * \cos(\delta) = 120 * 3 * 6.27 * \cos(14^\circ) = 2,190.15$$

$$\sigma_{p2} = \gamma Hk_p * \cos(\delta) = 120 * 5 * 6.27 * \cos(14^\circ) = 3,650.25$$

$$P_P = \left[\frac{2,190.15 + 3,650.25}{2} \right] 2 = 5,840.40$$

Step 2: Use Ovesen's theory to estimate the magnitude of the three-dimensional effects R, using Eq. 9-17.

$$R = 1 + \Delta K^{2/3} \left[1.1E^4 + \frac{1.6B}{1 + 5\frac{L}{H}} + \frac{0.4\Delta KE^3 B^2}{1 + 0.05\frac{L}{H}} \right]$$

$$\Delta K_{horz} = (K_p - K_a) \cos(\delta) = (6.27 - 0.27) \cos(14^\circ) = 5.82$$

$$B = 1 - \left(\frac{L}{S}\right)^2 = 1 - \left(\frac{2}{8}\right)^2 = 0.94$$

$$E = 1 - \frac{H}{d + H} = 1 - \frac{2}{3 + 2} = 0.60$$

$$R = 1 + 5.82^{2/3} \left[1.1 * 0.6^4 + \frac{1.6 * 0.94}{1 + 5\frac{2}{2}} + \frac{0.4 * 5.82 * 0.60^3 * 0.94^2}{1 + 0.05\frac{2}{2}} \right] = 3.46$$

$$R = 3.46 > 2.0 \quad Use \quad R = 2$$

Step 3: Calculate ultimate anchor block capacity, T_{ult} .

$$T_{ult} = R * (P_p - P_a) * L = 2 * (5,840.40 - 251.50) * 2 = 22,355.6 \text{ lb/ft}$$

Where L is the length of the anchor block.

$$FS = \frac{T_{ult}}{T} = \frac{22,355.6}{11,000.0} = 2.03$$

9.2 HEAVE

The condition of heave can occur in soft plastic clays when the depth of the excavation is sufficient to cause the surrounding clay soil to displace vertically with a corresponding upward movement of the material in the bottom of the excavation.

The possibility of heave and slip circle failure in soft clays, and in the underlying clay layers, should be checked when the Stability Number (N_o) exceeds 6.

$$\text{Stability Number, } N_o = \gamma H / C \quad \text{Eq. 9-25}$$

Where:

γ = Unit weight of the soil in pcf

H = Height of the excavation in ft

C = Cohesion of soil in psf

Braced cuts in clay may become unstable as a result of heaving of the bottom of the excavation. Terzaghi (1943) analyzed the factor of safety of long braced excavations against bottom heave. The failure surface for such a case is shown in Figure 9-12. The vertical load per unit length of cut at the bottom of the cut along line dc is:

$$Q = W + (0.7B)q - S \quad \text{Eq. 9-26}$$

Where:

Q = Vertical load per unit length.

W = Weight of soil column in pounds = γH .

B = Width of open excavation in feet.

q = Surcharge loading in psf.

S = Resistance of soil due to cohesion over depth of excavation H (cH) in plf

c = Cohesion of soil in psf.

H = Height of excavation in feet.

CONSTRUCTION AND SPECIAL CONSIDERATIONS

The load Q may be treated as a load per unit length on a continuous foundation at the level of dc and having a width of $0.7B$. Based on Terzaghi's bearing capacity theory, the net ultimate load-carrying capacity per unit length is:

$$Q_U = cN_c(0.7B) \quad \text{Eq. 9-27}$$

Where:

Q_U = Ultimate load carry capacity per unit length.

c = Cohesion of soil in psf.

N_c = Bearing capacity factor from Figure 9-13.

B = Width of open excavation in feet.

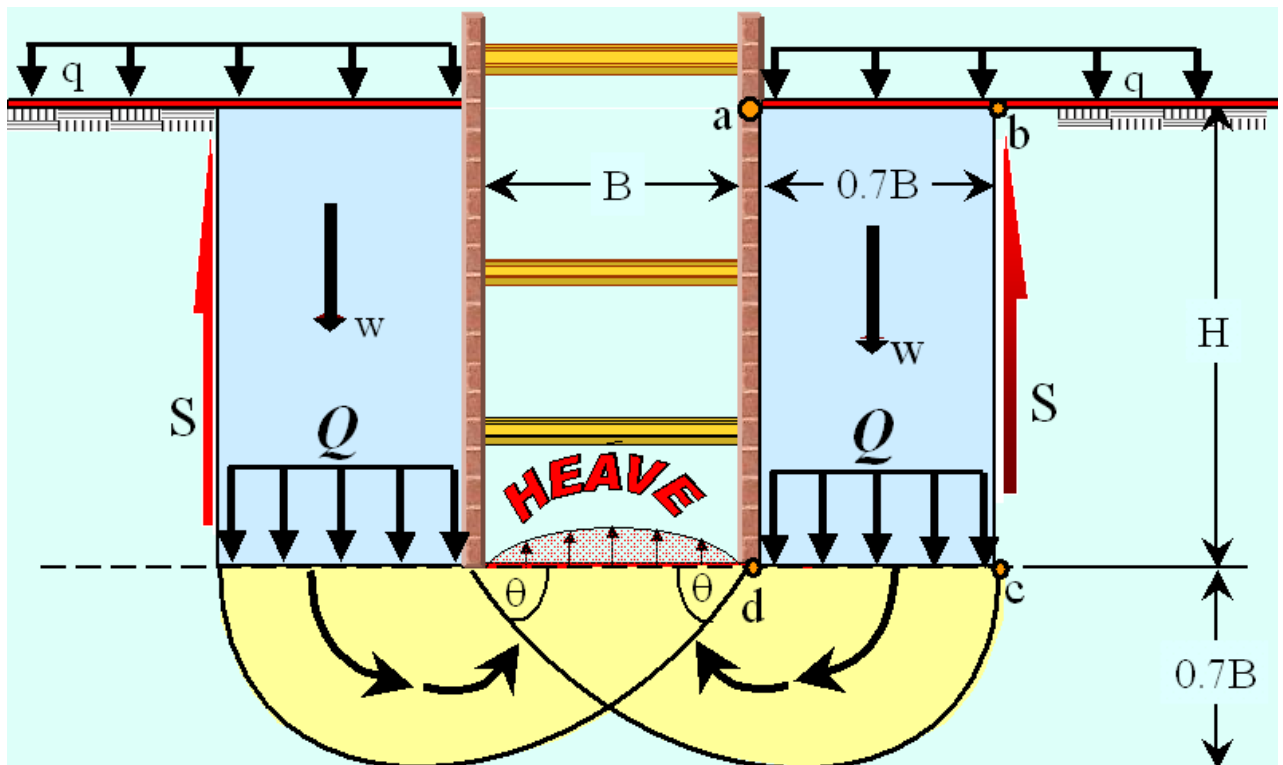

Figure 9-12. Bottom Heave

It is recommended that a minimum safety factor of 1.5 should be used.

If the analysis indicates that heave is probable, modifications to the shoring system may be needed. The sheeting may be extended below the bottom of the excavation into a more stable layer, or for a distance of one-half the width of the excavation (typically valid for only excavations where $H > B$). Another possible solution when in submerged condition or when in clay could be to over-excavate and construct a counterweight to the heaving force.

NOTE - Strutting a wall near its bottom will not prevent heave but such strutting may prevent the wall from rotating into the excavation.

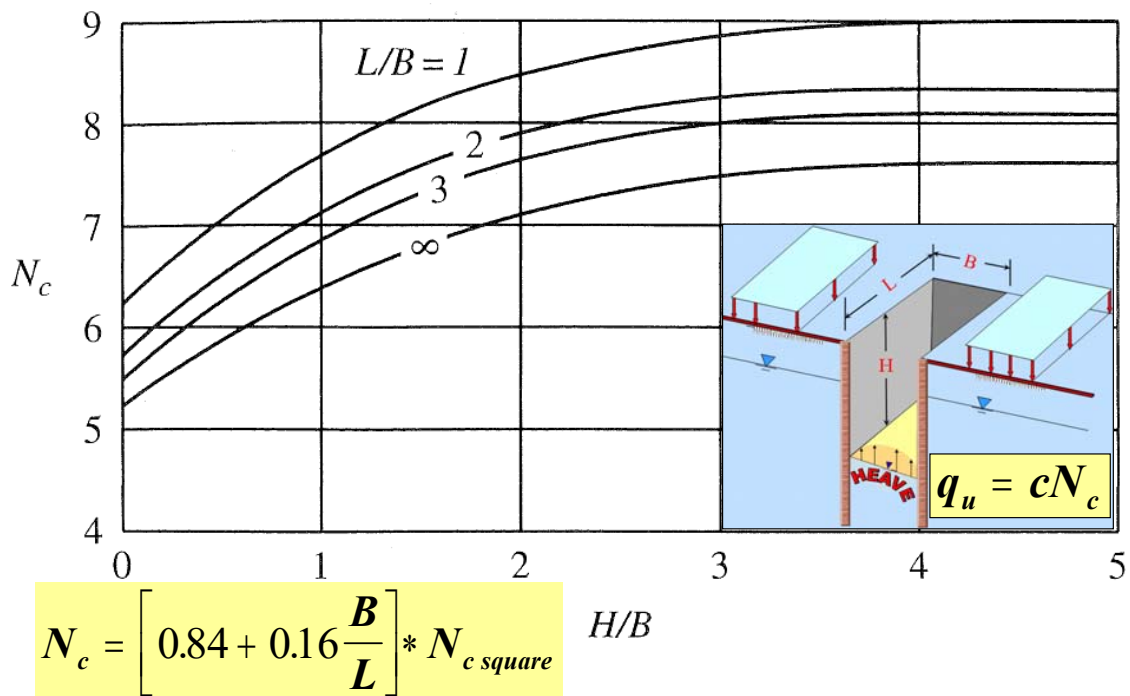

Figure 9-13. Bearing Capacity Factor

9.2.1 Factor of Safety Against Heave

The factor of safety against bottom heave as shown in Figure 9-14 is:

$$FS = \frac{F_{RS}}{F_{DR}} \geq 1.5 \quad \text{Eq. 9-28}$$

Where:

F_{RS} = Resisting Force = Q_U from Eq. 9-27.

F_{DR} = Driving Force = Q from Eq. 9-26

CONSTRUCTION AND SPECIAL CONSIDERATIONS

This factor of safety is based on the assumption that the clay layer is homogeneous, at least to a depth of $0.7B$ below the bottom of the excavation. However, if a hard layer of rock or rocklike material at a depth of $D < 0.7B$ is present, then the failure surface will need to be modified to some extent. Note that B' shown in Figure 9-14 below is equal to $0.7B$.

The bearing capacity factor, N_c , shown in Figure 9-13, varies with the ratios of H/B and L/B . In general, for H/B :

$$N_{c(\text{rectangle})} = N_{c(\text{square})} \left(0.84 + 0.16 \frac{B}{L} \right) \quad \text{Eq. 9-29}$$

Where:

$N_{c(\text{square})}$ = Bearing capacity factor based on $L/B=1$.

B = Width of excavation in feet

L = Length of excavation in feet

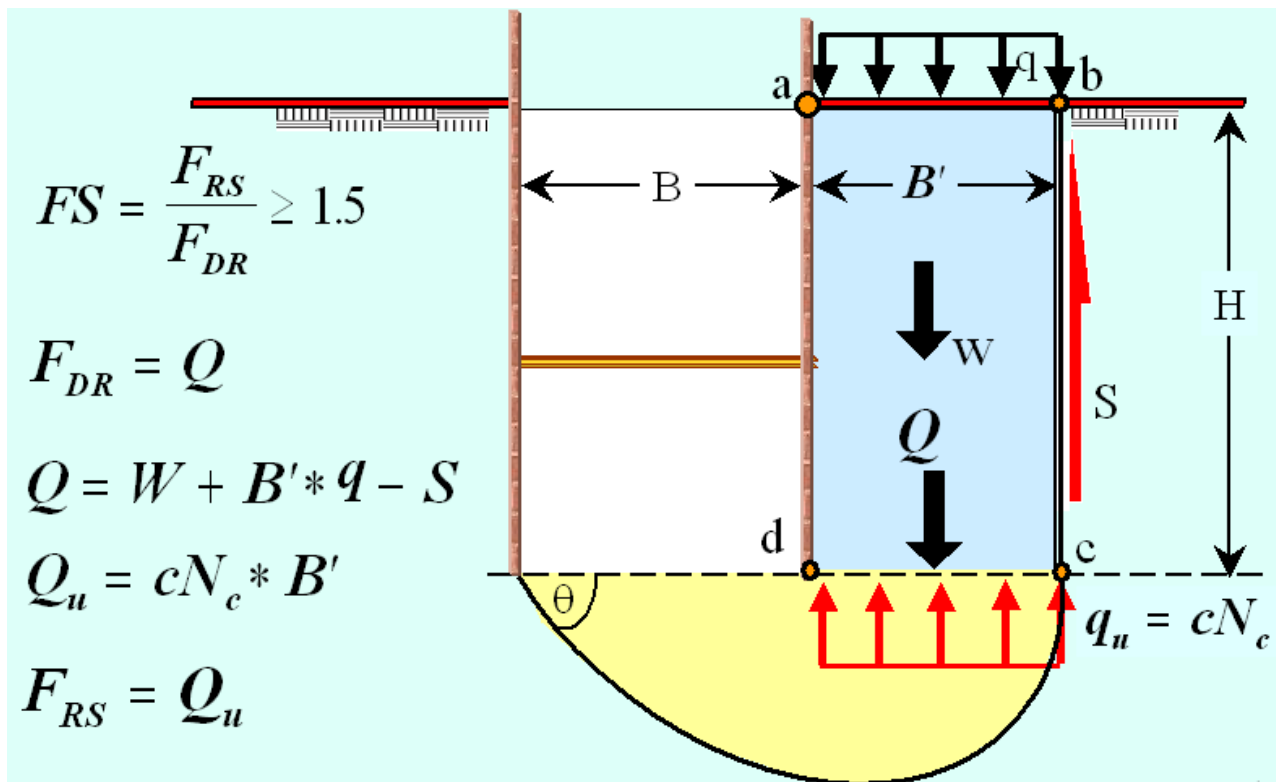

Figure 9-14. Factor of safety

9.2.1.1 Example 9-2 Problem – Heave Factor of Safety

Given: $H = 30'$, $B = 15'$, $L = 45'$
 $q = 300$ psf, $c = 500$ psf, $\gamma = 120$ pcf

Solution:

Note in the following example $B' = 0.7B = 0.7(15) = 10.5'$.

$N_{c(\text{square})}$ as determined from Figure 9-13 for $H/B = 2$ is 8.5.

$$\frac{H}{B} = 2.0 \quad \frac{L}{B} = 3$$

$$N_c = \left[0.84 + 0.16 \frac{B}{L} \right] * N_{c \text{ square}}$$

$$N_c = \left[0.84 + 0.16 \frac{15}{45} \right] * 8.5 = 7.60$$

$$q_u = 0.50 * 7.60 = 3.80 \text{ ksf}$$

$$F_{DR} = W + B' * q - S$$

$$W = (10.5 * 30) 0.120 = 37.8$$

$$B' * q = 10.5 * 0.30 = 3.15$$

$$S = 0.5 * 30 = 15$$

$$F_{DR} = 37.8 + 3.15 - 15 \approx 26.0$$

$$F_{RE} = q_u B' = 3.8 * 10.5 \approx 40.0$$

$$FS = \frac{40.0}{26.0} = 1.54 \geq 1.5$$

$$q_u = c N_c$$

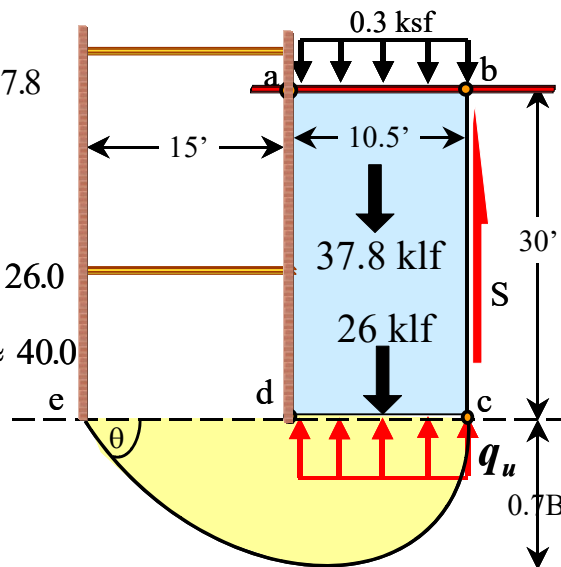
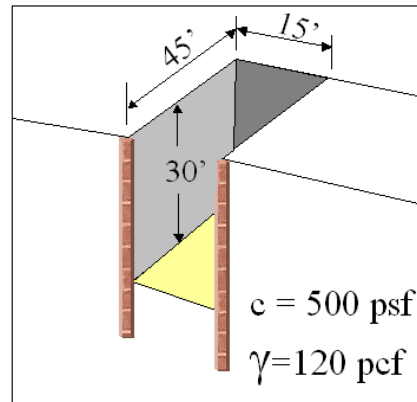

Figure 9-15. Heave example problem

9.3 PIPING

For excavations in pervious materials (sands), the condition of piping can occur when an unbalanced hydrostatic head exists. This causes large upward flows of water through the soil and into the bottom of the excavation. This movement of water into the excavation will transport material and will cause settlement of the soil adjacent to the excavation, if the piping is allowed to continue. This is also known as a sand boil or a quick condition. The passive resistance of embedded members will be reduced in this condition.

To correct this problem, either equalize the unbalanced hydraulic head by allowing the excavation to fill with water or lower the water table outside the excavation by dewatering. On Caltrans projects, one of the common methods used to protect or mitigate against piping is the use of a seal course. Refer to BCM 130-17.0 for additional information regarding seal course construction.

If the embedded length of the shoring system member is long enough, the condition of piping should not develop. Charts giving lengths of sheet pile embedment, which will result in an adequate factor of safety against piping, are shown on page 65 of the USS Steel Sheet Piling Design Manual. These charts are of particular interest and a good resource for cofferdams.

9.3.1 Hydraulic Forces on Cofferdams and Other Structures

Moving water imposes not only normal forces acting on the normal projection of the cofferdam but also substantial forces in the form of eddies can act along the sides of sheet piles as shown in the figure below. The drag force (D) in equation form (after Ratay) is:

$$D = (A)(C_d)(\rho)\frac{V^2}{2g} \quad \text{Eq. 9-30}$$

Where:

ρ = Water density in lbs/ft³

A = Projected area of the obstruction normal to the current in ft²

C_d = Coefficient of drag, dimensionless

V = Velocity of the current in ft/sec

g = Acceleration due to gravity ft/sec²

In English units $\rho \approx 2g$ so that:

$$D = (A)(C_d)(V^2) \quad \text{Eq. 9-31}$$

Where:

A = Projected area of the obstruction normal to the current in ft^2

V = Velocity of the current in ft/sec

C_d = Coefficient of drag, $\text{lbs sec}^2/\text{ft}^4$ (Note: C_d is not dimensionless in the above equation for D to be in lbs .)



Figure 9-16. Hydraulic forces on cofferdams

Considering the roughness along the sides of the obstructions (as for a sheetpile cofferdam) the practical value for $C_d = 2.0$.

$$D = 2AV^2$$

Which may be considered to be applied in the same manner as a wind rectangular load on the loaded height of the obstruction.

Example: Determine the drag force on a six foot diameter corrugated metal pipe placed vertically in water of average depth of 6 feet flowing at 4 feet per second.

$$\text{Projected Area} = 6(6) = 36 \text{ ft}^2.$$

$$D = 2(36)(4)^2 = 1,152 \text{ lbs.}$$

9.4 SLOPE STABILITY

When the ground surface is not horizontal at the construction site, a component of gravity may cause the soil to move in the direction of the slope. Slopes fail in different ways. Figure 9-17 shows some of the most common patterns of slope failure in soil. The slope failure of rocks is out of the scope of this Manual.

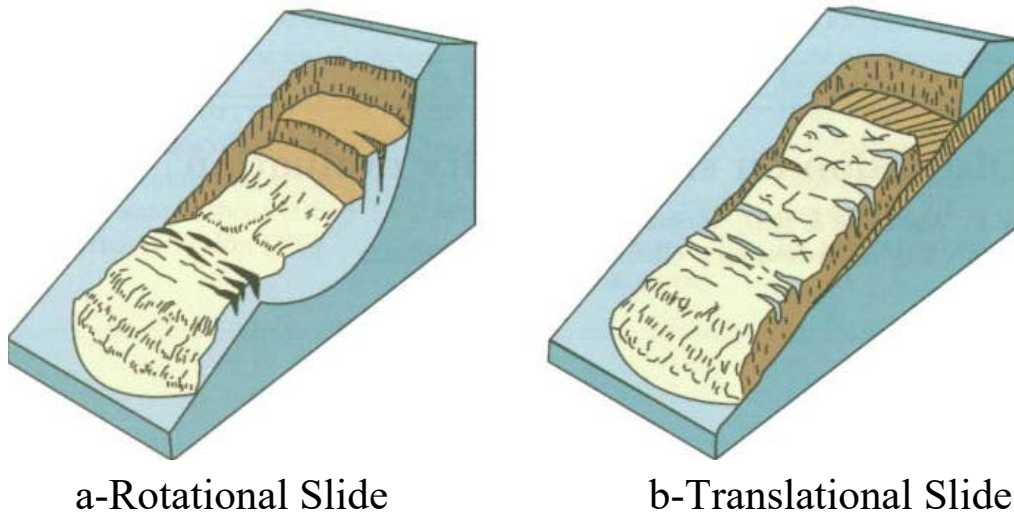

Figure 9-17. Common pattern of soil slope failure (USGS)

A slope stability analysis can be very complex and is most properly within the realm of geotechnical engineering. In many cases, construction engineers and geotechnical engineers are expected to perform a slope stability analysis to check the safety of an excavated slope. There are various computer programs for slope stability analyses, using conventional limited equilibrium method or the strength reduction method based on finite element analysis.

The fundamental assumption of the limit-equilibrium method is that failure occurs when a mass of a soil slides along a slip surface as shown in Figure 9-17. The popularity of limit-equilibrium methods is primarily due to their relative simplicity, and the many years of experience analyzing slope failures.

Construction equipment, stockpiles and other surcharges, which may cause excavation instabilities, should be considered when performing a slope stability analysis. The slope stability analysis involves the following:

- Obtain surface geometry, stratigraphy and subsurface information
- Determine soil shear strengths
- Determine soil-structure-interaction such as presence of sheet piles, soldier piles tieback, soil nails and so forth
- Determine surcharge loads
- Perform slope stability analysis to calculate the minimum factor of safety against failure for various stage constructions

The stability of an excavated slope is expressed in terms of the lowest factor of safety, FS, found utilizing multiple potential failure surfaces. Circular solutions to slope stability have been developed primarily due of the ease this geometry lends to the computational procedure. The most critical failure surface will be dependent on site geology and other factors mentioned above. However, the most critical failure surface is not necessarily circular as shown in Figure 9-17. Non-circular failure surfaces can be caused by adversely dipping bedding planes, zones of weak soil or unfavorable ground water conditions.

9.4.1 Rotational Slides

Slope stability analysis of slopes with circular failure surfaces can be explained using method of slices as shown in Figure 9-18 in which AB is an arc of a circle representing a trial failure surface. The soil above the trial surface is divided into number of slices. The forces acting on a typical slice *i* are shown in Figure 9-18 b, c and d. The ordinary method of slices, which is the simplest method, does not consider interslice forces acting on the side of the slices. The Simplified Bishop's Method of Slices accounts only for the horizontal interslice forces while more refined methods such as Spencer's solution, accounts for both vertical and horizontal interslice forces acting on each side of the slice.

CONSTRUCTION AND SPECIAL CONSIDERATIONS

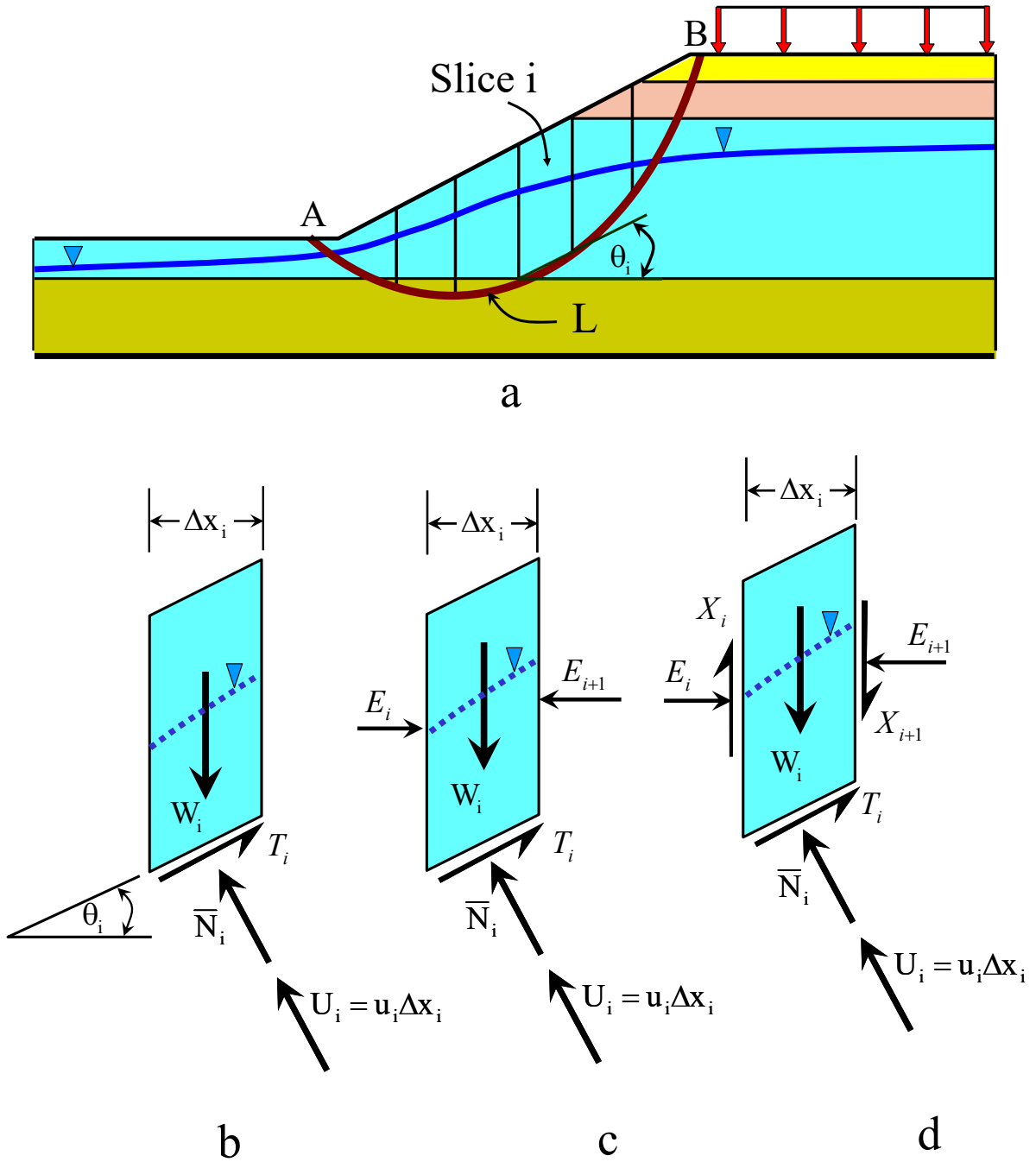

Figure 9-18. Method of slices and forces acting on a slice

Variations of this method used for investigating the factor of safety for potential stability failure include:

'Fellenius Method of Slices'

'Simplified Bishop Method of Slices'

'Spencer and Janbu Method of Slices'

Also known as 'Ordinary Method of Slices' or 'Swedish Circle', the Fellenius Method was published in 1936. The Simplified Bishop Method (1955) also uses the method of slices to find the factor of safety for the soil mass. The failure is assumed to occur by rotation of a mass of soil on a circular slip surface centered on a common point as shown in Figure 9-18.

The basic equation for each of these methods is:

$$F = \frac{\bar{C}L + \tan \bar{\phi} \sum_{i=1}^{i=n} \bar{N}_i}{\sum_{i=1}^{i=n} W_i \sin \theta_i}$$

Nomenclature

F = Factor of safety

F_a = Assumed factor of safety

i = Represents the current slice

$\bar{\phi}$ = Friction angle based on effective stresses

\bar{C} = Cohesion intercept based on effective stresses

W_i = Weight of the slice

\bar{N}_i = Effective normal force

θ_i = Angle from the horizontal of a tangent at the center of the slice along the slip surface

T_i = Tensile force

u_i = Pore-water pressure force on a slice

U_i = Resultant neutral (pore-water pressure) force

Δl_i = Length of the failure arc cut by the slice

L = Length of the entire failure arc

CONSTRUCTION AND SPECIAL CONSIDERATIONS

For major excavations in side slopes, slope stability failure for the entire system should be investigated.

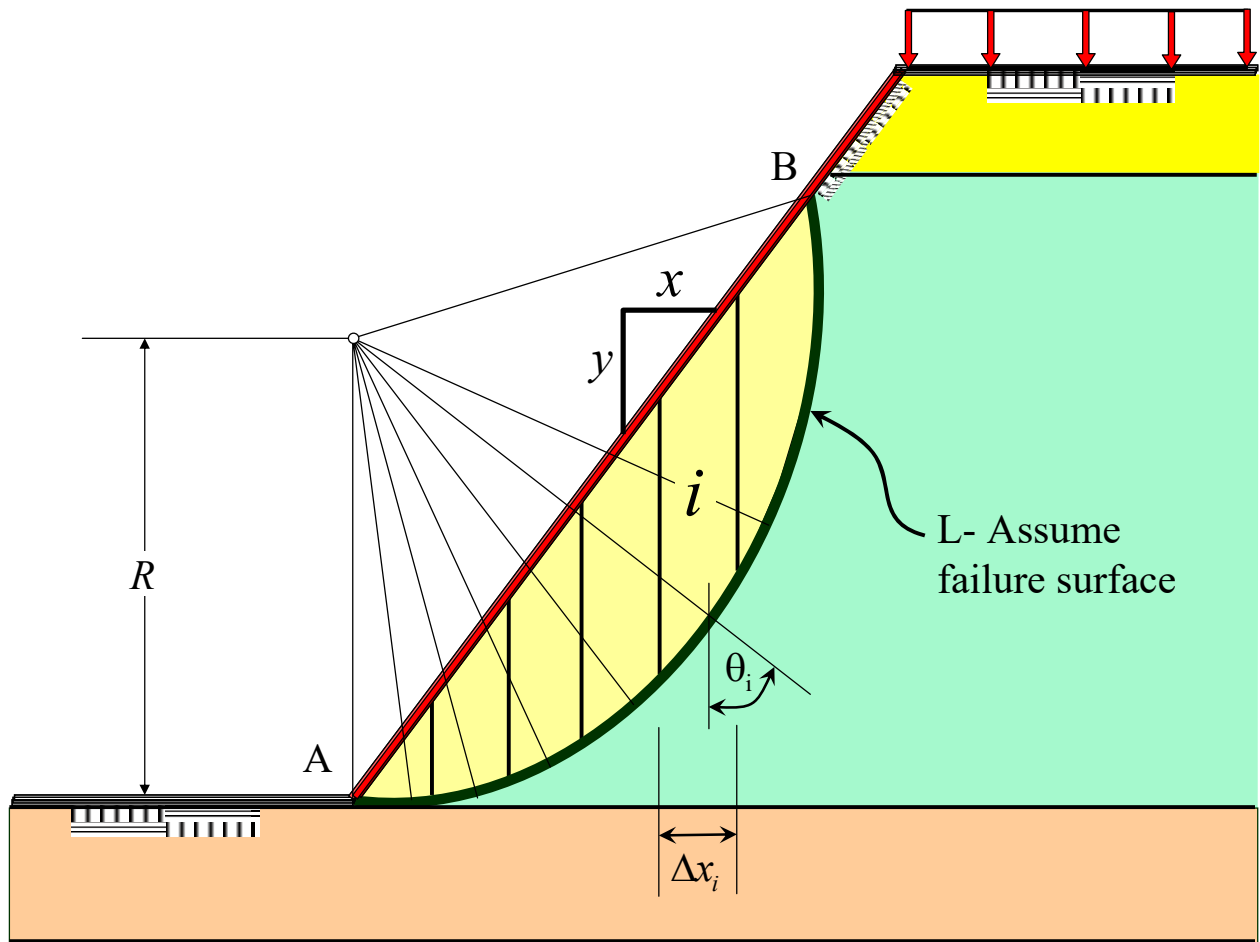

Figure 9-19. A Trial Surface, for Fellenius and Bishop method of slices

9.4.2 Fellenius Method

This method assumes that for any slice, the forces acting upon its sides have a resultant of zero in the direction normal to the failure arc. This method errs on the safe side, but is widely used in practice because of its early origins and simplicity.

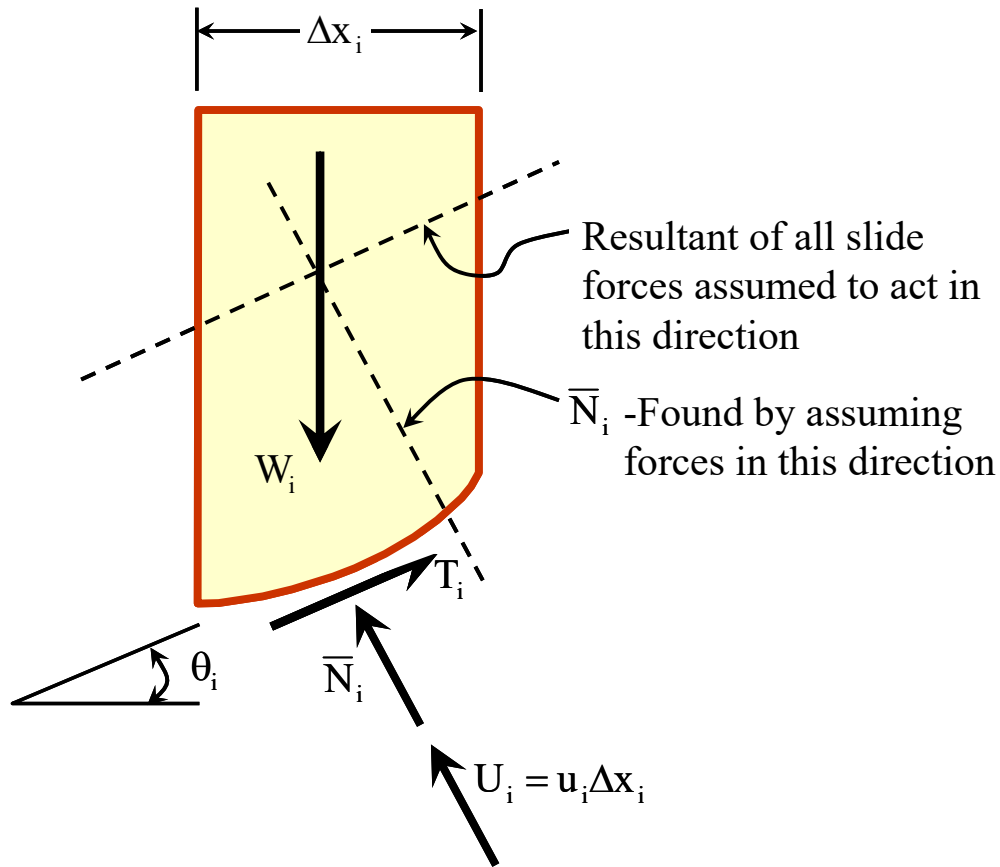

Figure 9-20. Slice i, Fellenius Method

$$\bar{N}_i = W_i \cos \theta_i - u_i \Delta_i l_i$$

The basic equation becomes:

$$F = \frac{\bar{C}L + \tan \bar{\phi} \sum_{i=1}^{i=n} (W_i \cos \theta_i - u_i \Delta_i l_i)}{\sum_{i=1}^{i=n} W_i \sin \theta_i}$$

CONSTRUCTION AND SPECIAL CONSIDERATIONS

The procedure is to investigate many possible failure planes, with different centers and radii, to zero in on the most critical.

9.4.2.1 Example 9-3 Problem – Fellenius Method

Given: $\gamma = 115$ pcf $\bar{\phi} = 30^\circ$ $\bar{C} = 200$ psf No Groundwater

Solution:

The trial failure mass is divided into 6 slices with equal width as shown in Figure 9-21.

Each slice makes an angle θ with respect to horizontal as shown in Table 9-1.

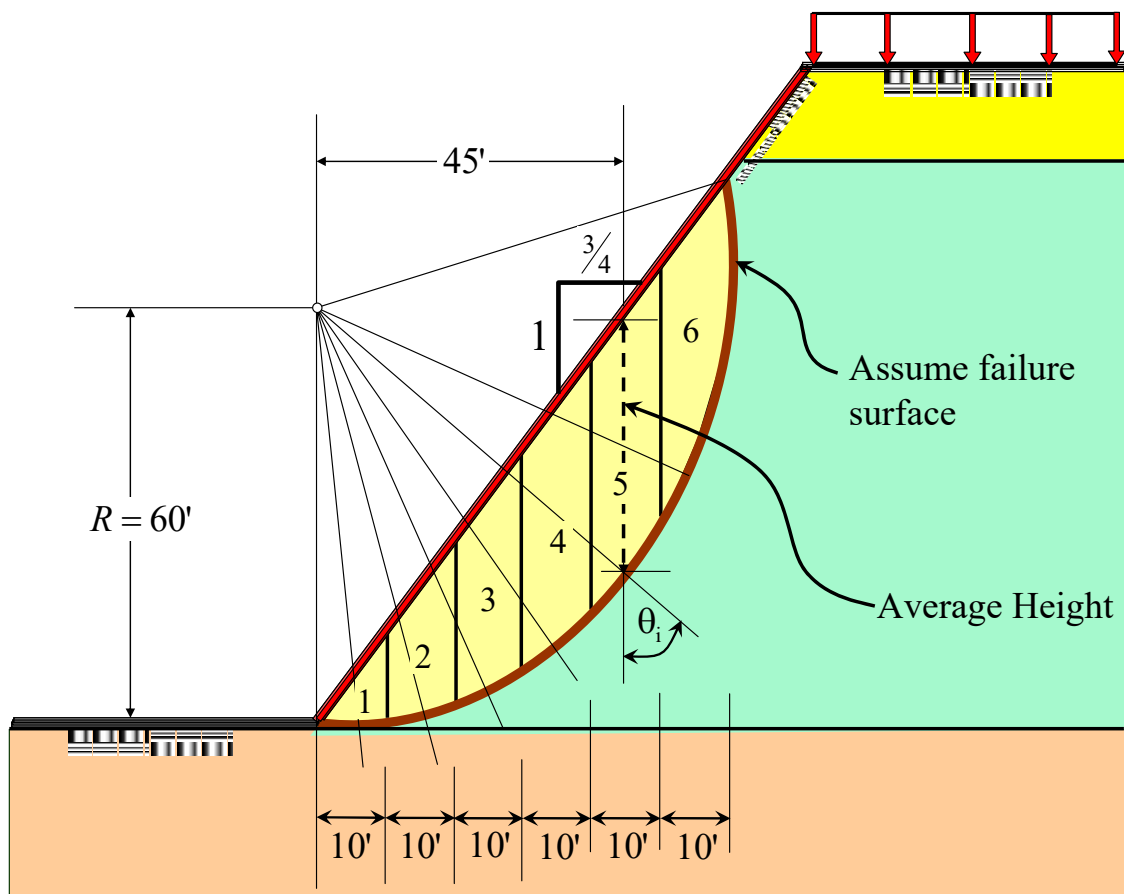

Figure 9-21. Example of Fellenius and Bishop method of slices

CT TRENCHING AND SHORING MANUAL

Table 9-1. Fellenius Table of Slices

Angles θ_i (°)	Average Height (ft)	Slice Weights (kips)
$\theta_1 = \sin^{-1}(6.7/60) = 6.41^\circ$	12.4	$W_1 = (1/2) (12.4) (10) (0.115) = 7.13$
$\theta_2 = \sin^{-1}(15.0/60) = 14.47^\circ$	17.8	$W_2 = (17.8) (10) (0.115) = 20.47$
$\theta_3 = \sin^{-1}(25.0/60) = 24.62^\circ$	27.6	$W_3 = (27.6) (10) (0.115) = 31.74$
$\theta_4 = \sin^{-1}(35.0/60) = 35.69^\circ$	34.7	$W_4 = (34.7) (10) (0.115) = 39.91$
$\theta_5 = \sin^{-1}(45.0/60) = 48.59^\circ$	40.0	$W_5 = (40.0) (10) (0.115) = 46.00$
$\theta_6 = \sin^{-1}(55.0/60) = 66.44^\circ$	35.8	$W_6 = (35.8) (10) (0.115) = 41.17$

Slice	θ_i (°)	W_i (kips)	$W_i \sin \theta_i$	$W_i \cos \theta_i$	\bar{N}_i
1	6.41	7.13	0.80	7.09	7.09
2	14.47	20.47	5.11	19.82	19.82
3	24.62	31.74	13.22	28.85	28.85
4	35.69	39.91	23.28	32.41	32.41
5	48.59	46.00	34.50	30.43	30.43
6	66.44	41.17	<u>37.74</u>	16.46	<u>16.46</u>
			$\Sigma = 114.66$	$\Sigma = 135.06$	

$$U_i = 0$$

$$L = 112 \text{ ft (by geometry)}$$

$$F = \frac{(0.2)(112) + (0.577)(135.06)}{114.66} = 0.87 < 1$$

This is the value for one trial failure plane. Additional trials are necessary to determine the critical one that gives the minimum factor of safety. The slope for this sample problem is deemed to be unstable since the computed safety factor determined by this single calculation is less than one.

9.4.3 Bishop Method

This method assumes that the forces acting on the sides of any slice have a zero resultant in the vertical direction.

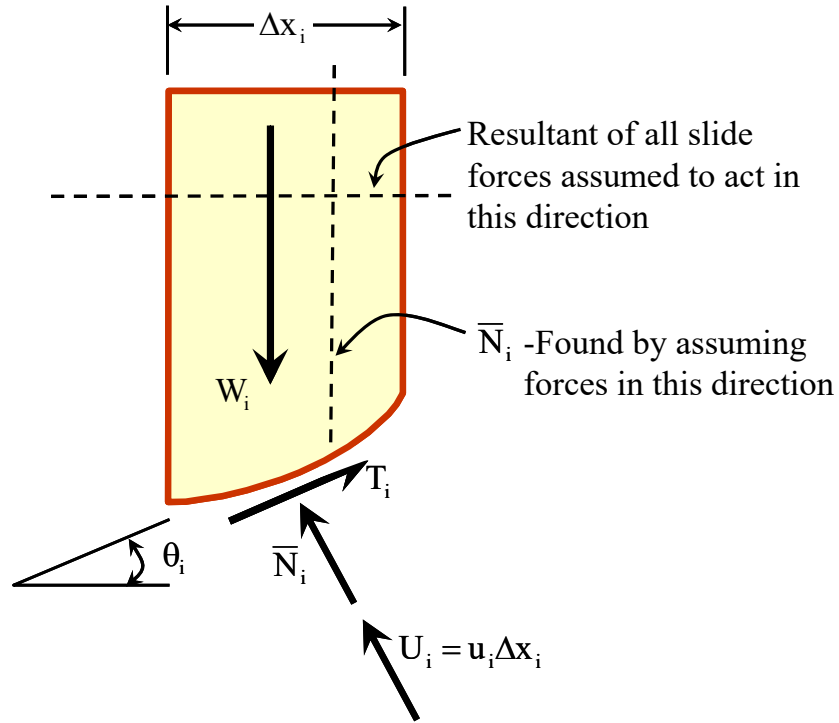

Figure 9-22. Slice i , Bishop Method

$$N_i = \frac{W_i - u_i \Delta x_i - \frac{\bar{C} \Delta x_i \tan \theta_i}{F_a}}{\cos \theta_i \left\{ 1 + \frac{\tan \theta_i \tan \bar{\phi}}{F_a} \right\}}$$

The basic equation becomes:

$$F = \frac{\sum_{i=n}^{i=n} \left(\frac{\bar{C} \Delta x_i + (W_i - u_i \Delta x_i) \tan \bar{\phi}}{M_i} \right)}{\sum_{i=n}^{i=n} W_i \sin \theta_i}$$

$$\text{Where: } M_i = \cos \theta_i \left\{ 1 + \frac{\tan \theta_i \tan \bar{\phi}}{F_a} \right\}$$

For the Bishop Method, the Factor of Safety (F_a) must be assumed and a trial and error solution is required. The assumed “ F_a ’s” converge on the Factor of Safety for that trial failure plane. Good agreement between the assumed “ F_a ” and the calculated “ F ” indicated the selection of center and radius was good.

9.4.3.1 Example 9-4 Problem – Bishop Method

Given: $\gamma = 115$ pcf $\bar{\phi} = 30^\circ$ $\bar{C} = 200$ psf No Groundwater

Solution:

Column	<u>A</u>	<u>B</u>	<u>C</u>	<u>D</u>	<u>E</u>	<u>F</u>	<u>G</u>
Slice	θ_i	W_i	$\bar{C} \Delta x_i$	$W_i \tan \bar{\phi}$	$\cos \theta_i$	$\tan \theta_i \tan \bar{\phi}$	$\underline{C} + \underline{D}$
1	6.41	7.13	2	4.12	0.99	0.06	6.12
2	14.47	20.47	2	11.82	0.97	0.15	13.82
3	24.62	31.74	2	18.33	0.91	0.26	20.33
4	35.69	39.91	2	23.04	0.81	0.41	25.04
5	48.59	46.00	2	26.56	0.66	0.65	28.56
6	66.44	41.17	2	23.77	0.40	1.32	25.77

Column	<u>Ha</u>	<u>Hb</u>	<u>Ia</u>	<u>Ib</u>	<u>J</u>
Slice	M_i $F_a = 1.5$	$F_a = 0.8$	$\frac{G}{H_a}$ $F_a = 1.5$	$\frac{G}{H_b}$ $F_a = 0.8$	$W_i \sin \theta_i$
1	1.04	1.07	5.94	5.72	0.80
2	1.06	1.15	12.92	12.02	5.11
3	1.07	1.21	19.00	16.94	13.22
4	1.04	1.23	24.31	20.36	23.28
5	0.95	1.20	30.06	23.80	34.50
6	0.75	1.06	<u>34.36</u>	<u>24.31</u>	<u>37.74</u>
			$\Sigma = 126.59$	$\Sigma = 103.15$	$\Sigma = 114.65$

For $F_a = 1.5$: $F = \frac{126.59}{114.65} = 1.104$ The factor of safety for this trial

For $F_a = 0.8$: $F = \frac{103.15}{114.65} = 0.900$ converges to ≈ 0.9

Again, this is the value for one trial failure plane. Additional trials are necessary to determine the critical one that gives the minimum factor of safety.

If ground water were present, pore pressure would need to be considered. The values are most typically field measured.

9.4.4 Translational Slide

For excavations into stratified deposits where the strata are dipping toward the excavation or there is a definite plane of weakness near the base of the slope, the slope may fail along a plane parallel to the weak strata as shown in Figure 9-23.

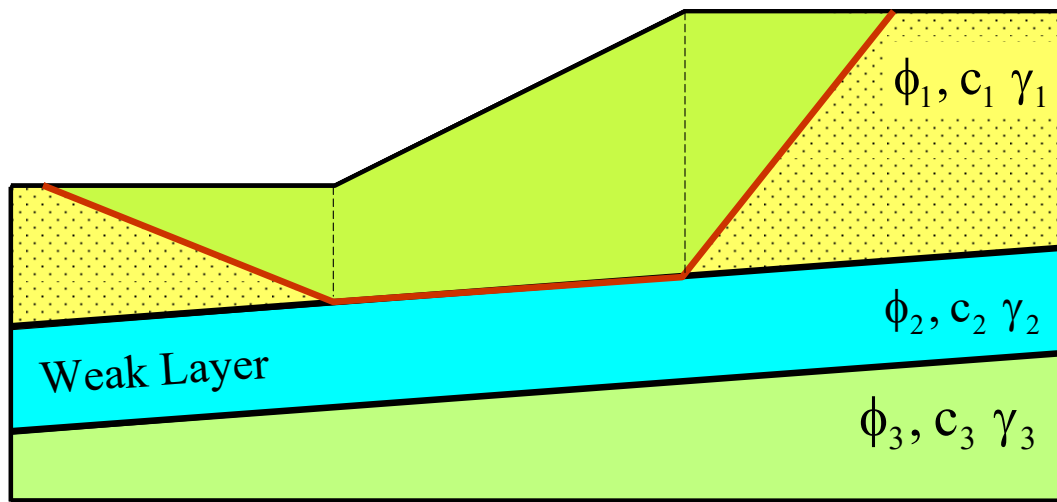
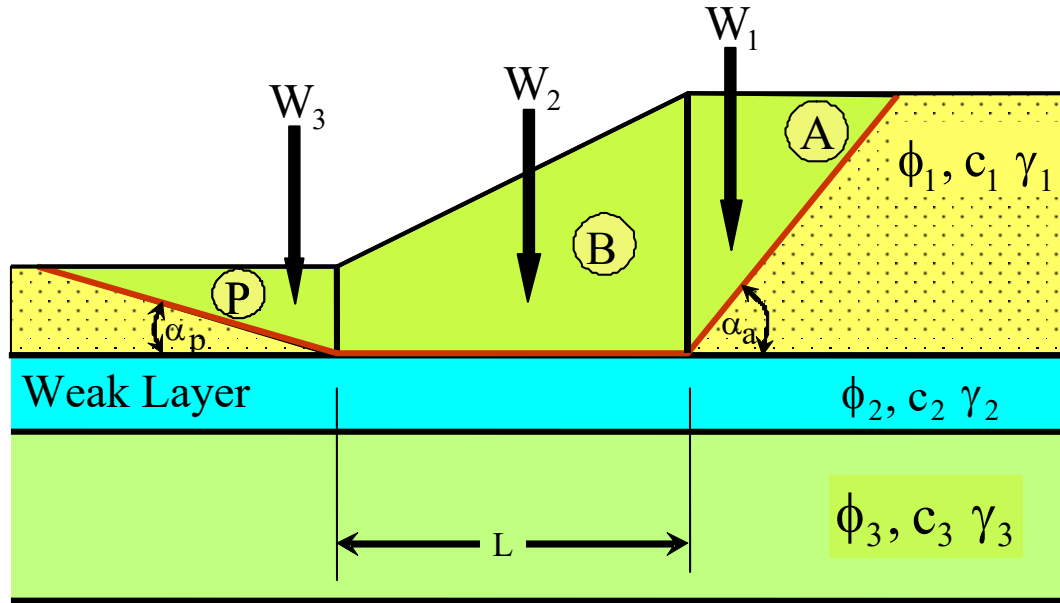

Figure 9-23. Mechanism of Translational Slide

The movement of the soil mass within the failure surface is translational rather than rotational. Methods of analysis that consider blocks or wedges sliding along plane surfaces shall be used to analyze slopes with a specific plane of weakness.

Figure 9-24 shows a sliding mass consisting of a tri-planar surface. The force equilibrium of the blocks or wedges is more sensitive to shear forces than moment equilibrium as shown in Figure 9-24. The potential failure mass consists of an upper or active Block A, a central or neutral Block B and a lower or passive Block P. The active earth pressure from Block A tends to initiate translational movement. This movement is opposed by the passive resistance to sliding of Block P and by shearing resistance along the base of central Block B. The critical failure surface can be located using an iterative process as explained previously.



a

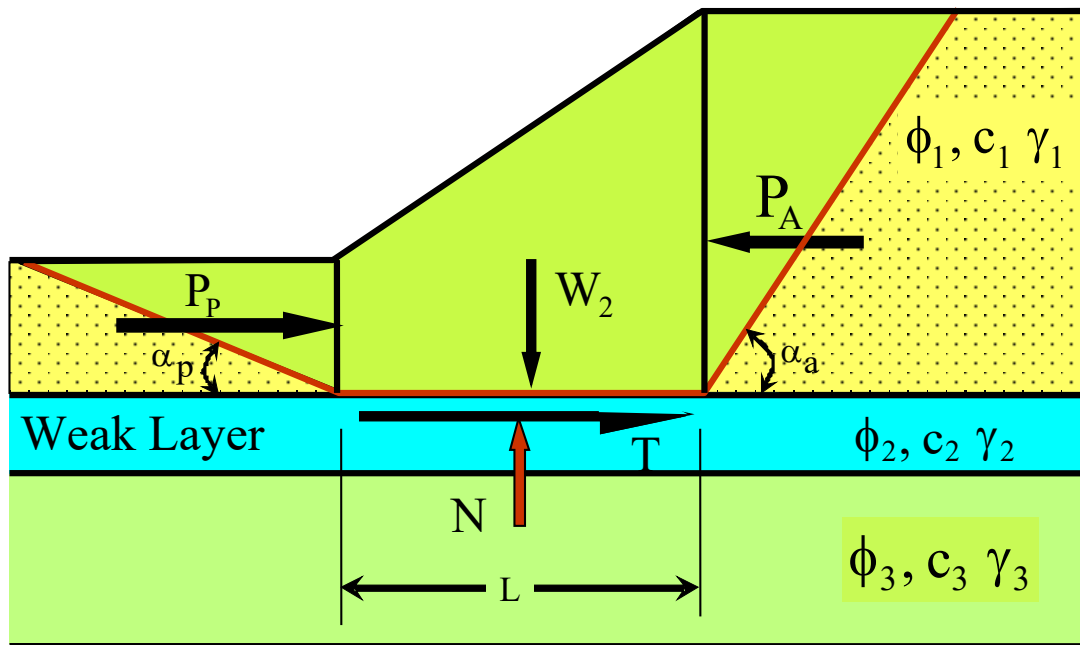

b

Figure 9-24. Mechanism of Translational Slide

The Factor of Safety of the slope against translational sliding is established by the ratio of resisting to driving forces. The resisting force is a function of passive pressure at the toe of the slope and the shearing resistance along the base of Block B. The driving force is the

CONSTRUCTION AND SPECIAL CONSIDERATIONS

active earth pressure due to thrust of Block A. Thus the Factor of Safety can be expressed as follows:

$$FS = \frac{T + W_2 * \tan \phi_2 + P_p}{P_a}$$

In which:

$$T = c_2 * L + W_2 * \tan \phi_2$$

Where:

T = tangential resistance force at the base of Block B

c = unit cohesion along base of the Block B

W₂ = weight of section of Block B

L = length of base of Block B

P_p = passive pressure on Block B P_p = W₃ tan(α_p + φ₁)

P_a = resultant active pressure on Block B P_a = W₁ tan(α_a - φ₁)

W₁ = weight of section of Block A

W₃ = weight of section of Block C

α_p = failure plane angle with horizontal for passive pressure

α_a = failure plane angle with horizontal for active pressure

φ₁ = internal friction angle of soil for Block A

φ₂ = internal friction angle of soil for Block C

FS = Factor of Safety

9.4.5 Stability Analysis of Shoring Systems

Deep-seated stability failure should be investigated for major shoring systems such as tieback walls. The slip surface passes behind the anchors and underneath the base tip of the vertical structural members as shown in Figure 9-26a. A minimum factor of safety of 1.25 is required for the deep-seated stability failure. Local system failure should also be investigated for major tieback systems as shown in Figure 9-26b. The trial surface shall extend to the depth of the excavation to calculate the minimum factor of safety of 1.25. The un-bonded length shall extend beyond the failure surface.

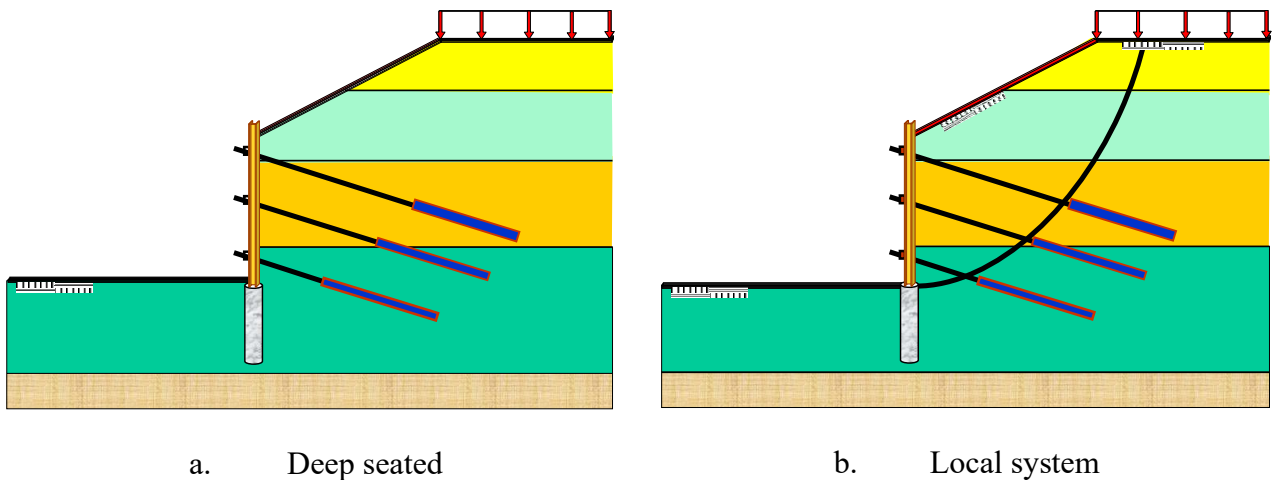

Figure 9-26. Stability failure modes

9.4.6 The Last Word on Stability

The previous slope stability discussion serves to demonstrate the complexity of stability analysis. Soil failure analysis should not be limited to circular arc solutions. There are various computer programs for slope stability analysis using non-circular shapes.

When it appears that shoring or a cut slope presents a possibility of some form of slip failure, a stability analysis should be requested from the contractor. Submittals relative to the soils data and analysis should be from a recognized soils lab or from a qualified Geotechnical Engineer or Geologist. In addition, Geotechnical Services in Sacramento has the capability of performing computer aided stability analysis to verify the submitted analysis.

9.5 CONSTRUCTION CONSIDERATIONS

9.5.1 Construction

The integrity of a shoring system, like any other structure, is dependent upon the adequacy of the design, the quality of the materials used and the quality of the workmanship. Frequent and thorough inspection of the excavation and the shoring system during all stages of construction must be performed by qualified personnel. An awareness of the changing conditions is essential. The following is a list of potential / common considerations:

1. Check to ensure the contractor has a current excavation permit from Cal-OSHA. The permits are valid for January 1 to December 31, and must be renewed each year.
2. Prior to the beginning of excavation work, become familiar with all aspects of the approved plans, the location of the work, assumptions made, available soils data, ground water conditions, surcharge loads expected, sequence of operations, location of utilities and underground obstructions, and any other factors that may restrict the work at the site.
3. Since the primary function of the shoring is the protection of the workers, adjacent property and the public, it is essential that the inspector be knowledgeable in the minimum safety requirements.
4. Check all soil being excavated to confirm that it is consistent with the log of test borings and/or with what is contemplated in the excavation plan.
5. Check for changes in the groundwater conditions.
6. As the excavation progresses, be alert for indicators of distress such as tension cracks forming, potential failure of structural members or subsidence of soil near the excavation
7. If the excavation is sloped back without shoring, the need for inspection remains. Sloughing and cave-ins can occur. As always, verify that the slope configurations are per the approved plan.
8. Review all the materials for quality, integrity and/or strength grade specified. Also check members for bending, buckling and crushing.
9. For shored excavations, check the shoring members for size and spacing as shown on the approved plans. The sequence of operations shown on the plans must be followed.

CONSTRUCTION AND SPECIAL CONSIDERATIONS

- Check for full bearing at the ends of jacks and struts and make sure they are secure and will not fall out under impact loads. Also check members for bending, buckling and crushing.
10. Manufactured products, such as hydraulic struts, jacks and shields, should be installed and used according to the manufacturer's recommendations.
 11. If a tieback system is used, the tiebacks should be installed per the approved plan and preloaded to avoid overloading individual ties.
 12. When cables are used in conjunction with anchors, they should not be wrapped around sharp corners. Thimbles should be used and cable clamps installed properly.
 13. Surcharge loads need to be monitored to verify that such loads do not exceed the design assumptions for the system.
 14. Weather conditions may have an adverse affect on excavations and some materials, especially clays, may fail due to change in moisture content. Some situations may benefit by protecting the slopes with sheeting or other stabilizing material.
 15. Good workmanship makes an excavation safer and easier to inspect. Trouble spots are easier to detect when the excavation is uniform and straight.
 16. Vibrations from dynamic loadings such as vibratory equipment, pile driving or blasting operations require special attention.
 17. Utility owners should be notified prior to commencement of work if their facilities are within 5 times the excavation depth.
Underground Service Alert:
811 or 1-800-227-2600
Northern California (USA) www.usanorth.org
Southern California (USA) www.digalert.org
Statewide www.call811.com
 18. Encourage the use of benchmarks to monitor ground movement in the vicinity of the shoring system (within a distance of 10 times the shoring depth) before, during and after excavation. The benchmarks should be monitored for horizontal and vertical displacement. In general, ground settlement accompanies shoring deflection.

CT TRENCHING AND SHORING MANUAL

19. Egress provisions such as ladders, ramps, stairways, or other means shall be provided in excavations over 4 feet in depth so that no more than 25 feet of lateral travel is required to exit trench excavations.
20. Adequate protection from hazardous atmospheres must be provided. Air monitoring and other confined space regulations must be followed, including documentation.
21. Employees shall be protected from the hazards of accumulating water, loose or falling debris, or potentially unstable structures.
22. Daily inspections, inspections after storms, and those as otherwise required for hazardous conditions are to be made by a competent person. Inspections are to be conducted before the start of the work and as needed throughout the shift. The competent person will need to check for potential cave-ins, indications of failure of the system, and for hazardous atmospheres. When the competent person finds a hazardous situation he shall have the authority to remove the endangered employees from the area until the necessary precautions have been taken to ensure their safety.
23. Adequate barrier physical protection is to be provided at all excavations. All wells, pits, shafts, etc. shall be barricaded or covered. Upon completion of exploration and similar operations, temporary shafts, etc. shall be backfilled.

9.5.2 Encroachment Permit Projects

An Encroachment Permit is required for projects performed by others within State highway right-of-way or adjacent to State highways including those done under a Cooperative Agreement such as a Capital Improvement Project. The contractor, builder or owner must apply for and be issued an Encroachment Permit by the District Permits Engineer.

If the scope of work requires excavation and shoring, plans for this work must accompany the Permit application. The Plan must be reviewed and approved by the Permits Engineer prior to a Permit being issued. The Department has an obligation with respect to trenching and shoring work. Be informed of legal responsibilities and requirements. (Refer to CHAPTER 1)

Many of the encroachment permit projects are quite simple however; some might require complex shoring systems. The District Permits Engineer, on receipt of an application for an encroachment permit, will decide if technical assistance is necessary to review the Plan. The Plan may be routed to OSM, OSD or OSC.

The Plan must conform to all applicable requirements as outlined in CHAPTER 2 of this Manual. It must also conform to the requirements set forth in the Permit application. The review process is similar to the process for a typical State contract except that all correspondence regarding approval or rejection of the Plan must be routed through the Permits Engineer.

Note that consultants who prepare shoring plans for Encroachment Permit projects do not necessarily use the recommended allowable stresses given in this Manual. In making a review, keep this in mind. Acceptance should be based on nothing less than that required for a State project, with due consideration being given to the background of the contractor, the work to be done, and the degree of risk involved. Remember, geotechnical engineering is not an exact or precise science.

In order for the State to review and approve a contractor's excavation plan or proposed shoring system, a detailed plan of the work to be done must be submitted. As a minimum the shoring plan shall contain the following information:

CT TRENCHING AND SHORING MANUAL

Encroachment Permit No. (Contractor)

Contractor: (Name, Address, phone)

Owner: For whom the work is being done. Include Contract no or designation

Owner Encroachment Permit No.:

Location: Road, street, highway stationing, etc. indicating the scope or extent of the project.

Purpose: A description of what the trench or excavation is for (sewer line, retaining wall, etc).

Soil Profile: A description of the soil including the basis of identification such as surface observation, test borings, observation of adjacent work in same type of material, reference to a soils investigation report, etc.

Surcharge Loadings:

Any loads, including normal construction loads, that are adjacent to the excavation or trench should be identified and shown on the plans with all pertinent dimensions; examples are highways, railroads, existing structures, etc. The lateral pressures due to these loads will then be added to the basic soil pressures. The minimum surcharge is to be used where not exceeded by above loading considerations.

Excavation/Trenching & Shoring Plan:

The Plan for simple trench work can be in the form of a letter covering the items required. For more complex systems, a complete description of the shoring system including all members, materials, spacing, etc, is required. The Plan may be in the form of a drawing or referenced to the applicable portions of the Construction Safety Orders. In accordance with California Labor Code (CA law), if a shoring system varies from Title 8 of the Safety Orders, then the shoring plans must be prepared and signed by an engineer who is registered as a Civil Engineer in the State of California.

CONSTRUCTION AND SPECIAL CONSIDERATIONS

Manufactured Data:

Catalogs or engineering data for a product should be identified in the plan as supporting data. All specific items or applicable conditions must be outlined on the submittal.

Construction Permit:

Any plan or information submitted should confirm that a permit has been secured from Cal/OSHA to perform the excavation work. This is not an approval of the shoring system by Cal/OSHA.

Inspection: The contractor's plan must designate who the competent person on site will be.

The State Department of Transportation will review a Contractor's shoring plan in accordance with applicable State Specifications and the Construction Safety Orders. Deviations from Cal/OSHA or different approaches will be considered, providing adequate supporting data such as calculations, soils investigations, manufacturer's engineering data and references are submitted. The Caltrans Trenching & Shoring Manual is one of the resources available to assist the Engineer during the shoring plan review process.

The inspection of the fieldwork is the responsibility of the District Permits Engineer and his staff. However, there will be occasions where the complexity of the excavation and/or shoring requires assistance from OSC. For major Encroachment Permit projects the District may request that OSC assign an Engineer as a representative of the District Permits Engineer. Remember that the administrative or control procedure is different from typical State construction contracts. The OSC person assisting the Permits Engineer is a representative of the Permits Engineer not the Resident Engineer. Major corrections must be routed through the Permits Engineer. If there are difficulties with compliance, the Permits Engineer has the authority to withdraw the Encroachment Permit, which would have the effect of stopping the work. Close communication between OSC and the Permits Engineer is very important during all phases of the Encroachment Permit project.

In addition to verifying that the excavation and/or shoring work is in conformance with the approved Plan, a portion of the field review or monitoring will be to verify that the contractor and/or owner have all of the proper permits to do the work.

For more information regarding the Encroachment Permit process, contact your local District Permits Engineer or click on the link below.

http://www.dot.ca.gov/hq/traffops/developserv/permits/encroachment_permits_manual/index.html

9.5.3 Tieback Systems

9.5.3.1 Construction Sequence

The construction sequence for an anchored sheet pile or soldier pile system must be considered when making an engineering analysis. Different loads are imposed on the system before and after the completion of a level of tieback anchors. An analysis should be included for each stage of construction and an analysis may be needed for each stage of anchor removal during backfilling operations

9.5.3.2 Tieback Anchor Systems

There are many variations or configurations of tieback anchor systems. The tension element of a tieback may be either prestressing strands or bars using either single or multiple elements. Tiebacks may be anchored against wales, piles, or anchor blocks, which are placed directly on the soil. The example problems in this chapter illustrate the use of tiebacks with several different types of shoring systems.

Figure 9-27 illustrates a typical temporary tieback anchor. In this diagram, a bar tendon system is shown; strand systems are similar.

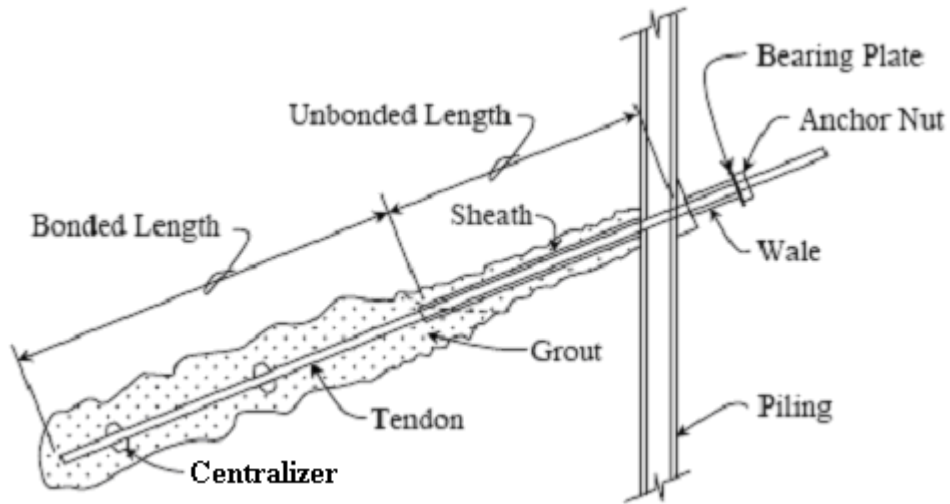

Figure 9-27. Typical temporary tieback

The more common components, criteria, and materials used in conjunction with tieback shoring systems are listed below:

- Piling Sheet piling and soldier piles. See CHAPTER 5 for common materials and allowable stresses.

- Wale These components transfer the resultant of the earth pressure from the piling to the tieback anchor. A design overstress of 33% is permitted for wales when proof testing the tieback anchor. Anchors for temporary work, are often anchored directly against the soldier piling through holes or slots made in the flanges, eliminating the need for wales. Bearing stiffeners and flange cover plates are generally added to the pile section to compensate for the loss of section. A structural analysis of this cut section should always be required.

- Tendon Tieback tendons are generally the same high strength bars or strands used in prestressing structural concrete.

The anchorage of the tieback tendons at the shoring members consists of

CT TRENCHING AND SHORING MANUAL

bearing plates and anchor nuts for bar tendons and bearing plates, anchor head and strand wedges for strand tendons. The details of the anchorage must accommodate the inclination of the tieback relative to the face of the shoring members. Items that may be used to accomplish this are shims or wedge plates placed between the bearing plate and soldier pile or between the wale and sheet piling or soldier piles. Also, for bar tendons spherical anchor nuts with special bearing washers plus wedge washers if needed or specially machined anchor plates may be used.

The tendon should be centered within the drilled hole within its bonded length. This is accomplished by the use of centralizers (spacers) adequately spaced to prevent the tendon from contacting the sides of the drilled hole or by installation with the use of a hollow stem auger.

Stress Allowable tensile stress values are based on a percentage of the minimum tensile strength (F_{pu}) of the tendons as indicated below:

Bars: $F_{pu} = 150$ to 160 ksi

Strand: $F_{pu} = 270$ ksi

(Check manufacturers data for actual ultimate strength)

Allowable tensile stresses:

At design load $F_t \leq 0.6 F_{pu}$

At proof load $F_t \leq 0.8 F_{pu}$

(Both conditions must be checked.)

Grout A flowable portland cement mixture of grout or concrete which encapsulates the tendon and fills the drilled hole within the bonded length. Generally, a neat cement grout is used in drilled holes of diameters up to 8 inches. A sand-cement mixture is used for hole diameters greater than 8 inches. An aggregate concrete mix is commonly used in very large holes. Type I or II cement, is commonly recommended for tiebacks. Type III cement may be used when high early strength is desired. Grout, with very few exceptions, should always be injected at the bottom of the drilled hole.

CONSTRUCTION AND SPECIAL CONSIDERATIONS

This method ensures complete grouting and will displace any water that has accumulated in the hole.

9.5.3.3 Tieback Anchor

There are several different types of tieback anchors. Their capacity depends on a number of interrelated factors:

- Location - amount of overburden above the tieback
- Drilling method and drilled hole configuration
- Strength and type of the soil
- Relative density of the soil
- Grouting method
- Tendon type, size, and shape

Typical shapes of drilled holes for tieback anchors are depicted in Figure 9-28.

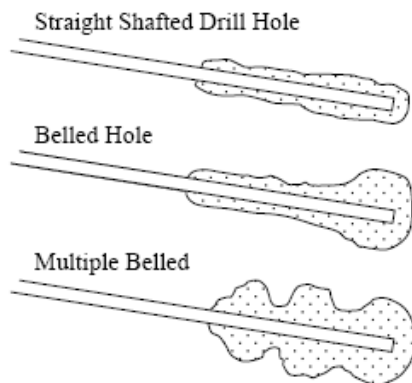

Figure 9-28. Anchor shapes

This is the simplest type and the one encountered most often.

In this case the resistance is a combination of perimeter bond and bearing against the soil.

Similar to above, this type of anchor is referred to as under-reamed. It is used in stiff cohesive soil. The soil must be stiff enough to prevent collapse of the under-reams or drill hole in the anchor length.

The presence of water either introduced during drilling or existing ground water can cause significant reduction in anchor capacity when using a rotary drilling method in some cohesive soils (generally the softer clays).

High pressure grouting of 150 psi or greater in granular soils can result in significantly greater tieback capacity than by tremie or low pressure grouting methods. High pressure grouting is seldom used for temporary tieback systems.

Re-grouting of tieback anchors has been used successfully to increase the capacity of an anchor. This method involves the placing of high-pressure grout in a previously formed anchor. Re-grouting breaks up the previously placed anchor grout and disperses new grout into the anchor zone; compressing the soil and forming an enlarged bulb of grout thereby increasing the anchor capacity. Re-grouting is done through a separate grout tube installed with the anchor tendon. The separate grout tube will generally have sealed ports uniformly spaced along its length, which open under pressure allowing the grout to exit into the previously formed anchor.

Due to the many factors involved, the determination of anchor capacity can vary quite widely. Proof tests or performance tests of the tiebacks are needed to confirm the anchor capacity. A Federal publication, the FHWA/RD-82/047 report on tiebacks, provides considerable information for estimating tieback capacities for the various types of tieback anchors. Also see "Supplemental Tieback Information" in Appendix E.

Bond capacity is the tieback's resistance to pull out, which is developed by the interaction of the anchor grout (or concrete) surface with the soil along the bonded length.

Determining or estimating the bond (resisting) capacity is a prime element in the design of a tieback anchor.

Some shoring designs may include a Soils Laboratory report, which will contain recommended value for the bond capacity to be used for tieback anchor design. The appropriateness of the value of the bond capacity will only be proven during tieback testing.

CONSTRUCTION AND SPECIAL CONSIDERATIONS

For most of the temporary shoring work normally encountered, the tieback anchors will be straight shafted with low-pressure grout placement. For these conditions the following criteria can generally be used for estimating the tieback anchor capacity.

The Engineer is only required to check the unbonded length of the tieback. The determination of the bonded length L_b and capacity of the tieback is solely the responsibility of the contractor. The minimum distance between the front of the bonded zone and the active failure surface behind the wall shall not be less $H/5$. In no case shall the minimum distance be less than 5 ft. The unbonded length shall not be less than 15 ft.

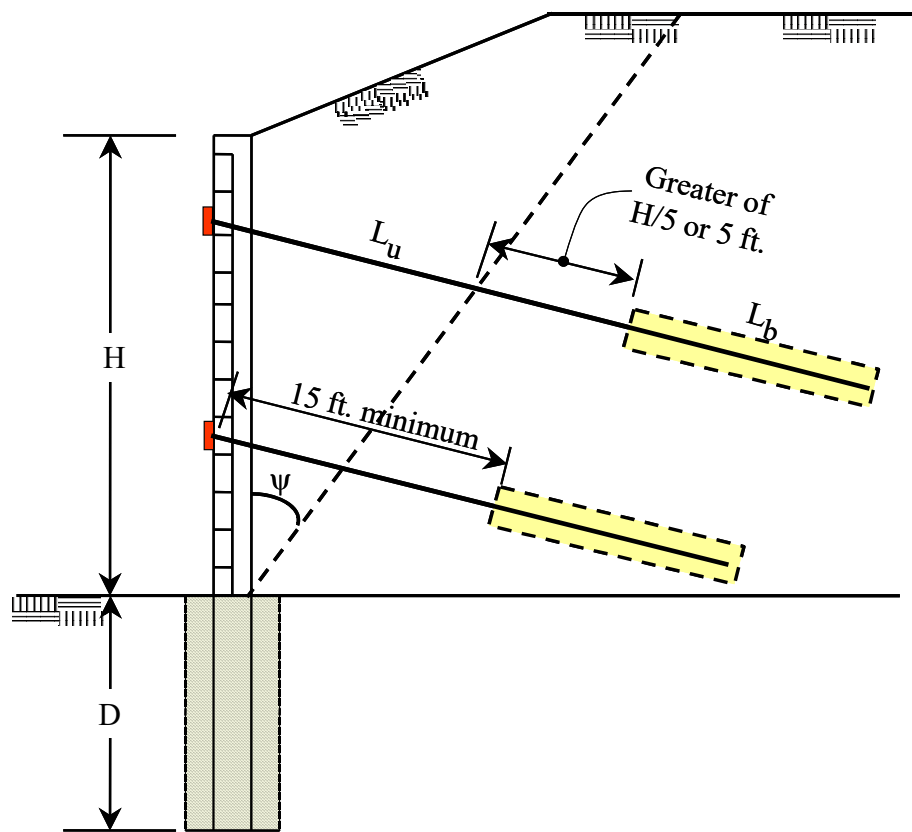

Figure 9-29. Bond Length

The ultimate capacity of the tieback is defined as follows:

$$P_{ult} = \pi d L_b S_b$$

Where:

- d = Diameter of drilled hole
- L_b = Bonded length of the tieback
- L_u = Unbonded length of the tieback
- S_b = Bond strength
- ψ = Angle between assumed failure plane and vertical

The bond strength for tiebacks depends on a number of interrelated factors:

- Location - amount of effective overburden pressure above the tieback
- Drilling method and drilled hole configuration
- Strength properties, type and relative density of the soil
- Grouting method and pressure

Therefore, bond strength must be included in the geotechnical report that is submitted by the Contractor just as any other soil property. The Geotechnical Services of the Division of Engineering Services (DES) is available for consultation for concerns or other information regarding bond strength.

9.5.3.4 Forces on the Vertical Members

Tiebacks are generally inclined; therefore the vertical component of the tieback force must be resisted by the vertical member through skin friction on the embedded length of the piling in contact with the soil and by end bearing. Problems with tieback walls have occurred because of excessive downward wall movement.

The vertical capacity of the shoring system should be checked when the initial review of the soil parameters indicates a problem may develop. Situations that can lead to problems with the vertical capacity are shoring embedded in loose granular material or soft clays. Vertical capacity should also be checked when tieback angles are steeper than

CONSTRUCTION AND SPECIAL CONSIDERATIONS

the standard 15 degrees or when there are multiple rows of tiebacks. The Engineer is reminded to contact Caltrans Geotechnical Services for assistance when performing a check of the vertical capacity of the shoring elements.

9.5.3.5 Testing Tieback Anchors

The Contractor is responsible for providing a reasonable test method for verifying the capacity of the tieback anchors after installation. Anchors are tested to ensure that they can sustain the design load over time without excessive movement. The need to test anchors is more important when the system will support, or be adjacent to existing structures, and when the system will be in place for an extended period of time.

The number of tiebacks tested; the duration of the test, and the allowable movement, or load loss, specified in the contractor's test methods should take into account the degree of risk to the adjacent surroundings. High-risk situations would be cases where settlement or other damage would be experienced by adjacent facilities. See Table 9-2 for a list of minimum recommended criteria for testing temporary tieback anchors.

Table 9-2. Tieback Proof Test Criteria

Test Load	Load Hold Duration	% of tiebacks to be load tested
<u>Cohesionless Soils</u> Normal Risk 1.2 to 1.3 Design Load	10 minutes	10% for each soil type encountered
High Risk 1.3 Design Load	10 minutes	20% to 100%
<u>Cohesive Soils</u> Normal Risk 1.2 to 1.3 Design Load	30 minutes	10%
High Risk 1.3 Design Load	60 minutes	30% to 100%
Use 100% when in soft clay or when ground water is encountered. Use load hold of 60 minutes for 10% and load hold of 10 minutes for remaining 90% of tiebacks		

CT TRENCHING AND SHORING MANUAL

Generally the shoring plans should include tieback load testing criteria which should minimally consist of proof load test values, frequency of testing (number of anchors to be tested), test load duration, and allowable movement or loss of load permissible during the testing time frame and the anticipated life of the shoring system. The shoring plans should also include the remedial measures that are to be taken when, or if, test anchors fail to meet the specified criteria.

Pressure gages or load cells used for determining test loads should have been recently calibrated by a certified lab, they should be clean and not abused, and they should be in good working order. The calibration dates should be determined and recorded.

Tiebacks that do not satisfy the testing criteria may still have some value. Often an auxiliary tieback may make up for the reduced value of adjacent tiebacks; or additional reduced value tiebacks may be installed to supplement the initial low value tiebacks.

9.5.3.6 Proof Testing

Applying a sustained proof load to a tieback anchor and measuring anchor movement over a specified period of time normally accomplish proof testing of tiebacks anchors. Proof testing may begin after the grout has achieved the desired strength. A specified number of the tieback anchors will be proof tested by the method specified on the Contractor's approved plans (see Table 9-2).

Generally, the unbonded length of a tieback is left ungrouted prior to and during testing (see Figure 9-30). This ensures that only the bonded length is carrying the proof load during testing. It is not desirable to have loads transferred to the soil through grout (or concrete) in the unbonded region since this length is considered to be within the zone of the failure wedge.

As an alternative, for small diameter drilled holes (6 inches or less) a plastic sheathing may be used over the unbonded length of the tendon to separate the tendon from the grout (see Figure 9-27). The sheathing permits the tendon to be grouted full length before proof testing. A void must be left between the top of the grout and the soldier pile to allow for movement of the grout column during testing.

Research has shown that small diameter tiebacks develop most of their capacity in the bonded length despite the additional grout in the unbonded length zone. This phenomenon is not true for larger diameter tieback anchors.

Generally the Contractor will specify an alignment load of 5% to 10% of the design load, which is initially applied to the tendon to secure the jack against the anchor head and stabilize the setup. The load is then increased until the proof load is achieved. Generally a maximum amount of time is specified to reach proof load. Once the proof load is attained, the load hold period begins. Movement of the tieback anchor is normally measured by using a dial indicator gage mounted on a tripod independent of the tieback and shoring and positioned in a manner similar to that shown in Figure 9-30.

The tip of the dial indicator gage is positioned against a flat surface perpendicular to the centerline of the tendon. (This can be a plate secured to the tendon). The piston of the jack may be used in lieu of a plate if the jack is not going to have to be cycled during the

test. As long as the dial indicator gage is mounted independently of the shoring system, only movement of the anchor due to the proof load will be measured. Continuous jacking to maintain the specified proof load during the load hold period is essential to offset losses resulting from anchor creep or movement of the shoring into the supporting soil.

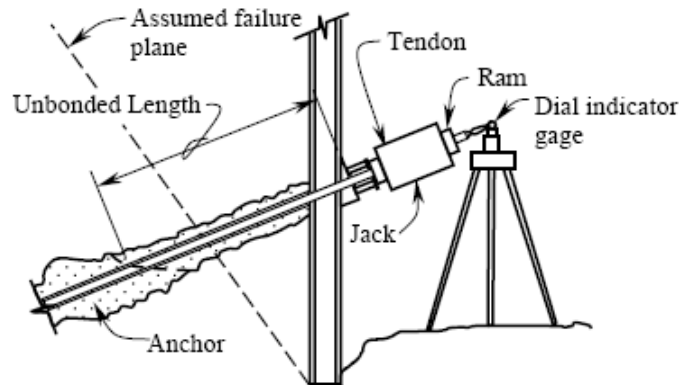

Figure 9-30. Proof Testing

Measurements from the dial indicator gage are taken periodically during the load hold period in accordance with the contractor's approved plan. The total movement measured during the load hold period of time is compared to the allowable value indicated on the approved shoring plans to determine the acceptability of the anchor.

It is important that the proof load be reached quickly. When excessive time is taken to reach the proof load, or the proof load is held for an excessive amount of time before beginning the measurement of creep movement, the creep rate indicated will not be representative. For the proof test to be accurate, the starting time must begin when the proof load is first reached.

As an alternative to measuring movement with a dial indicator gage, the contractor may propose a "lift-off test". A "lift-off test" compares the force on the tieback at seating to the force required to lift the anchor head off of the bearing plate. The comparison should be made over a specified period of time. The lost force can be converted into creep movement to provide an estimate of the amount of creep over the life of the shoring system.

Use of the "lift-off test" may not accurately predict overall anchor movement. During the time period between lock-off and lift-off, the tieback may creep and the wall may move into the soil. These two components cannot be separated. If the test is done accurately, results are likely to be a conservative measure of anchor movement. The Offices of Structure Construction recommends the use of a dial indicator gage to monitor creep rather than lift-off tests.

9.5.3.7 Evaluation of Creep Movement

Long-term tieback creep can be estimated from measurements taken during initial short term proof testing: In effect, measurements made at the time of proof testing can be extrapolated to determine anticipated total creep over the period the shoring system is in use if it is assumed that the anchor creep is roughly modeled by a curve described by the "log" of time.

The general formula listed below for the determination of the anticipated long-term creep is only an estimate of the potential anchor creep and should be used in conjunction with periodic monitoring of the wall movement. This formula will not accurately predict anchor creep for soft cohesive soils.

Based on the assumed creep behavior, the following formula can be utilized to evaluate the long-term effects of creep:

General formula:

$$\Delta_{2-3} = C \left[\log_{10} \left(\frac{T_3}{T_2} \right) \right]$$

Where:

$$C = \Delta_{1-2} / [\log_{10} (T_2 / T_1)]$$

Δ = Creep movement (inches) specified on the plans for times T_1 , T_2 , or T_3
(or measured in the field)

T_1 = Time of first movement measurement during load hold period
(usually 1 minute after proof load is applied)

T_2 = Time of last movement measurement during load hold period.

T_3 = Time the shoring system will be in use.

If using a “lift-off test” to estimate the creep movement, the following approximation needs to be made for substitution into the above equation:

$$\Delta_{1-1} = (P_1 - P_2) \frac{L_U}{AE}$$

Where:

P_1 = Force at seating

P_2 = Force at lift off

L_U = L_u + 0 to 5 feet of the bonded length necessary to develop the tendon

A = Area of strand or bar in anchor

E = Modulus of elasticity of the strand or bar in anchor

Example 9-6 demonstrates the calculation of long-term creep.

9.5.3.8 Wall Movement and Settlement

As a rule of thumb, the settlement of the soil behind a tieback wall, where the tiebacks are locked-off at a high percentage of the design force, can be approximated as equal to the movement at the top of the wall caused by anchor creep and deflection of the piling. Reference is made to Section 6.3 titled "DEFLECTION" of CHAPTER 6.

If a shoring system is to be in close proximity to an existing structure where settlement might be detrimental, significant deflection and creep of the shoring system would not be acceptable. If a shoring system will not affect permanent structures or when the shoring might support something like a haul road, reasonable lateral movement and settlement can be tolerated.

9.5.3.9 Performance Testing

Performance testing is similar to, but more extensive, than proof testing. Performance testing is used to establish the movement behavior for a tieback anchor at a particular site. Performance testing is not normally specified for temporary shoring, but it can be utilized to identify the causes of anchor movement. Performance testing consists of incremental loading and unloading of a tieback anchor in conjunction with measuring movement.

9.5.3.10 Lock-Off Force

The lock-off force is the percentage of the required design force that the anchor wedges or anchor nut is seated at after seating losses. A value of $0.8T_{\text{DESIGN}}$ is typically recommended as the lock-off force but lower or higher values are used to achieve specific design needs.

One method for obtaining the proper lock-off force for strand systems is to insert a shim plate under the anchor head equal to the elastic elongation of the tendon produced by a force equal to the proof load minus the lock-off load. A correction for seating of the wedges in the anchor head is often subtracted from the shim plate thickness. To determine the thickness of the shim plate you may use the following equation:

$$t_{shim} = \frac{(P_{proof} - P_{lockoff})L}{AE} - \Delta L$$

Where,

t_{shim} = thickness of shim

P_{proof} = Proof load

$P_{lockoff}$ = Lock-off load

A = Area of tendon steel (bar or strands)

E = Modulus of Elasticity of strand or bar

ΔL = seating loss

L = Elastic length of tendon (usually the unbonded length + 3 to 5 feet of the bonded length necessary to develop the tendon)

Seating loss can vary between $\frac{3}{8}$ " to $\frac{5}{8}$ " for strand systems. The seating loss should be determined by the designer of the system and verified during installation. Often times, wedges are mechanically seated minimizing seating loss resulting in the use of a lesser value for the seating loss. For thread bar systems, seating loss is much less than that for strand systems and can vary between 0" to $\frac{1}{16}$ ".

After seating the wedges in the anchor head at the proof load, the tendon is loaded, the shim is removed and the whole anchor head assembly is seated against the bearing plate.

9.5.3.11 Corrosion Protection

The contractor's submittal must address potential corrosion of the tendon after it has been stressed.

For very short-term installations in non-corrosive sites corrosion protection may not be necessary. The exposed steel may not be affected by a small amount of corrosion that occurs during its life.

For longer term installations grouting of the bonded and unbonded length is generally adequate to minimize corrosion in most non-corrosive sites. Encapsulating or coating any un-grouted portions (anchor head, bearing plate, wedges, strand, etc.) of the tieback system may be necessary to guard against corrosion.

For long-term installations or installations in corrosive sites, more elaborate corrosion protection schemes may be necessary. (Grease is often used as a corrosion inhibitor). Figure 9-31 depicts tendons encapsulated in pre-greased and pre-grouted plastic sheaths generally used for permanent installations.

CONSTRUCTION AND SPECIAL CONSIDERATIONS

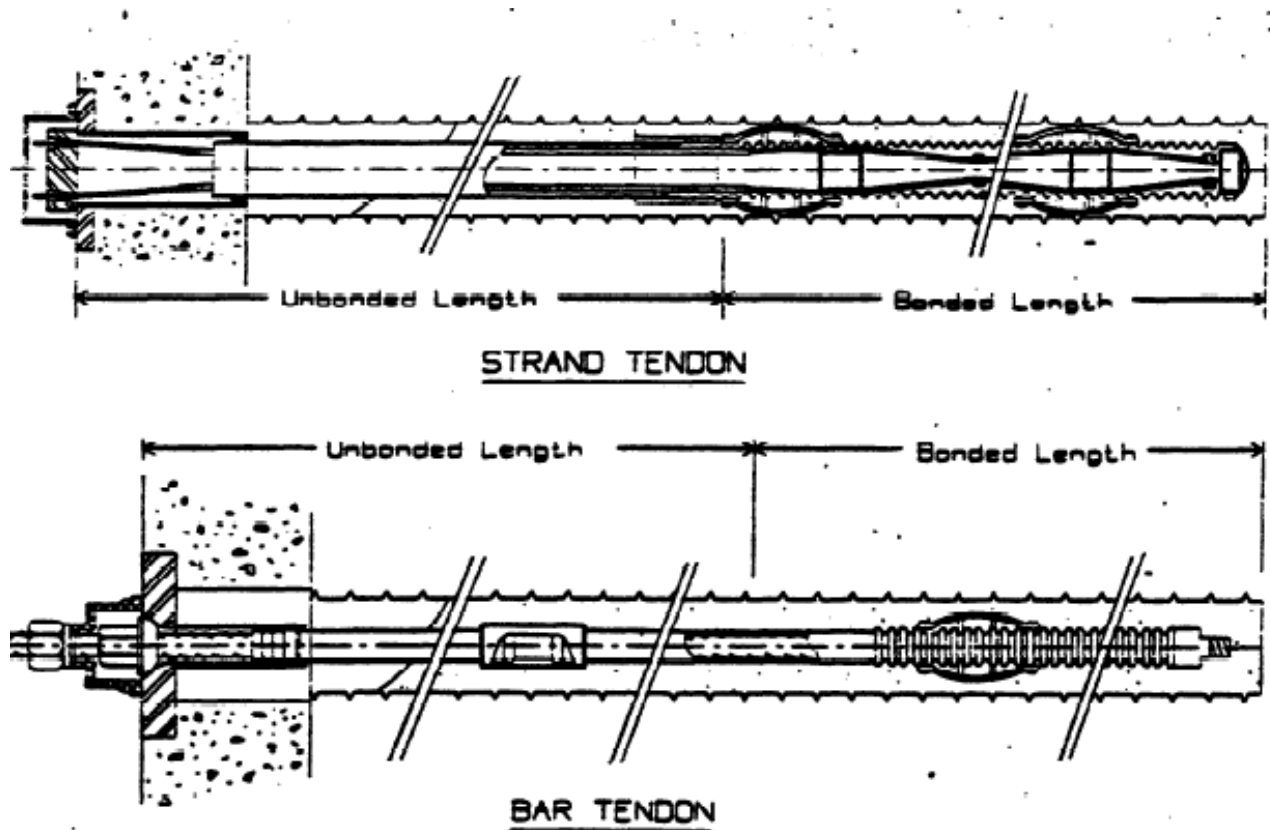

Figure 9-31. Bar or Strand Tendons

9.5.3.12 Steps for Checking Tieback Shoring Submittal

- 1 Review plans submittal for completeness.
- 2 Determine K_a and K_p
- 3 Develop pressure diagrams.
- 4 Determine forces.
- 5 Determine the moments around the top of the pile (or some other convenient location).
- 6 Solve for depth (D), for both lateral and vertical loads, and tieback force (T_H).
- 7 Check pile section.
- 8 Check anchor capacity.

9. Check miscellaneous details.
10. Check adequacy of tieback test procedure.
11. Review corrosion proposal.
12. General: Consider effects of wall deflection and subsequent soil settlement on any surface feature behind the shoring wall.

9.5.3.13 Example 9-6 Tieback Testing

Determine the long-term effects of creep.

9.5.3.13.1 Measurement and Time Method

Given:

The shoring plans indicate that a proof load shall be applied in 2 minutes or less then the load shall be held for ten minutes. The test begins immediately upon reaching the proof load value. Measurements of movement are to be taken at 1, 4, 6, 8 and 10 minutes. The proof load is to be 133% of the design load. The maximum permissible movement between 1 and 10 minutes of time will not exceed 0.1 inches. All tiebacks are to be tested. The system is anticipated to be in place for 1 year.

Solution:

$$\Delta = 0.1 \text{ inches}$$

$$T_1 = 1 \text{ minute}$$

$$T_2 = 10 \text{ minutes}$$

$$T_3 = (1Y) \left(365 \frac{D}{Y} \right) \left(24 \frac{H}{D} \right) \left(60 \frac{M}{H} \right) = 525,600 \text{ minutes}$$

$$C = \frac{\Delta_{1-2}}{\left[\log_{10} \left(\frac{T_2}{T_1} \right) \right]} = \frac{0.1}{\left[\log_{10} \left(\frac{10}{1} \right) \right]} = 0.1$$

CONSTRUCTION AND SPECIAL CONSIDERATIONS

$$\text{Long-term } \Delta_{2-3} = (C) \log_{10} \left(\frac{T_3}{T_2} \right) = (0.1) \log_{10} \left(\frac{525,600}{10} \right) = 0.47 \text{ inches} \approx \frac{1}{2} \text{ inch}$$

The proof load and duration of test are reasonable and exceed the minimums shown in Table 9-2. Applying the proof load in a short period of time and beginning the test immediately upon reaching that load ensure the test results will be meaningful and can be compared to the calculated long-term creep movement for the anchor.

If the shoring system were in close proximity to an existing structure that could not tolerate an 1/2 inch of settlement the design would not be acceptable. If the shoring would not affect permanent structures or when the shoring might support something like a haul road, the anticipated movement would be tolerable.

9.5.3.13.2 Lift Off Load Method

Given:

Lift off test will be performed 24 hours after wedges are seated (1 minute). The force at seating the wedges will be 83,000 pounds and the lift off force will be no less than 67,900 pounds.

$L \approx 20$ ft which is the unbonded length of 15' + 5'

$A = 0.647$ in²

$E = 28 \times 10^6$ psi

$T_2 = 1$ minute, this is the time the wedges are seated

$$\begin{aligned} \Delta_{1-2} &\approx \frac{(P_1 - P_2)L}{AE} \\ &\approx \frac{(83,000 - 67,900)(20)(12)}{(0.647)(28 \times 10^6)} \approx 0.2 \text{ in} \end{aligned}$$

$$C \approx \frac{0.2}{\left[\log_{10} \left(\frac{1440}{1} \right) \right]} = 0.06$$

$$\begin{aligned} \text{Long term } \Delta_{2-3} &\approx (C)\log_{10}\left(\frac{T_3}{T_2}\right) = (0.06)\log_{10}\left(\frac{525,600}{1}\right) \\ &\approx 0.34 \text{ inches} \approx \frac{5}{16} \text{ inch} \end{aligned}$$

9.6 SUMMARY

The Department has an obligation with respect to trenching and shoring work. Be informed of legal responsibilities and requirements (Refer to CHAPTER 1).

Soil Mechanics (Geotechnical Engineering) is not a precise science. Be aware of the effects assumptions can make. Simplified engineering analysis procedures can be used for much of the trenching and shoring work that will be encountered.

The actual construction work is of equal importance to the engineering design or planning. The Contractor and the Engineer must always be alert to changed conditions and must take appropriate action. Technical assistance is available. The Engineer at the jobsite must be able to recognize when he needs help. The need for good engineering judgment is essential.

Work involving railroads requires additional controls and specific administrative procedures.

The following is a summary of D.O.T. policy in regard to trench and excavation shoring work:

- 1 The law (State Statute, Section 137.6) requires that a California registered engineer review the Contractor's plans for temporary structures in connection with State Highway work. Shoring plans are included in this category.
- 2 The Resident Engineer will ascertain that the Contractor has obtained a proper excavation or trenching permit from Cal/OSHA before any work starts, and that the permit (or copy) is properly posted at the work site.
- 3 If the trench is less than 20 feet deep and the Contractor submits a plan in accordance with the Construction Safety Order Standard Details, it is not necessary to have the plans prepared by a Professional Engineer. The Resident Engineer will confirm that the Contractor's plan does indeed conform to the Cal/OSHA Standard Details and need not make an independent engineering analysis.
- 4 If a trench is over 20 feet in depth, or if the Cal/OSHA Details cannot be used; the plans must be prepared by a Professional Engineer.

CONSTRUCTION AND SPECIAL CONSIDERATIONS

5. When shoring plans are designed by firms specializing in temporary support systems and soil restraint (including sloping), good engineering judgment is to prevail for review. Shoring designs by such firms may appear less conservative when analyzed using the methods proposed in this Manual. Consequently, the shoring plan may need to be reviewed in the manner in which it was designed.
6. If the Contractor's shoring plan deviates from the Construction Safety Order Details, the plan must be prepared by a California Registered Professional Engineer and the reviewing Engineer will perform a structural analysis.
7. For any shoring work that requires review and approval by a Railroad, the Sacramento OSC Office will be the liaison between the project and the Railroad. The Structure Representative will submit the Contractor's shoring plans to OSC Sacramento after review. The review should be so complete that the plans are ready for approval. The Structure Representative should inform the Contractor of the proper procedure, and the time, required for Railroad review and approval.
8. Any revisions to plans should be done by the plan originator or by his authorized representative. Minor revisions may be made on plans but the revisions should be initialed and dated by the person making the changes.

Appendix A

CALIFORNIA OCCUPATIONAL SAFETY AND HEALTH STANDARDS FOR EXCAVATIONS

Appendix A text is
Construction Safety Order from
California Code of Regulations
(CCR), Title 8, Sections 1504,
1539, 1540, 1541, 1541.1
(including appendices A - F), and
Sections 1542 and 1543

Article 2. Definitions

1504. Definitions

Competent Person: One who is capable of identifying existing and predictable hazards in the surroundings or working conditions which are unsanitary, hazardous, or dangerous to employees, and who has authorization to take prompt corrective measures to eliminate them.

Excavation, Trenches, Earthwork.

- (A) **Bank.** A mass of soil rising above a digging level.
 - (B) **Exploration Shaft.** A shaft created and used for the purpose of obtaining subsurface data.
 - (C) **Geotechnical Specialist (GTS).** A person registered by the state as a Certified Engineering Geologist, or a Registered Civil Engineer trained in soil mechanics, or an engineering geologist or civil engineer with a minimum of three years applicable experience working under the direct supervision of either a Certified Engineering Geologist or Registered Civil Engineer.
- Hard Compact (as it applies to Section 1542).** All earth materials not classified as running soil.
- (E) **Lagging.** Boards which are joined, side-by-side, lining an excavation.
 - (F) **Running Soil (as it applies to Section 1542).** Earth material where the angle of repose is approximately zero, as in the case of soil in a nearly liquid state, or dry, unpacked sand which flows freely under slight pressure. Running material also includes loose or disturbed earth that can only be contained with solid sheeting.
 - (G) **Shaft.** An excavation under the earth's surface in which the depth is much greater than its cross-sectional dimensions, such as those formed to serve as wells, cesspools, certain foundation footings, and under streets, railroads, buildings, etc.

Article 6. Excavations

1539. Permits.

For regulations relating to Permits for excavations and trenches, refer to the California Code of Regulations Title 8, Chapter 3.2, Article 2, Section 341 of the California Occupational Safety and Health Regulations (Cal/OSHA).

1540. Excavations.

(a) Scope and application.

This article applies to all open excavations made in the earth's surface. Excavations are defined to include trenches.

(b) Definitions applicable to this article.

Accepted engineering practices means those requirements which are compatible with standards of practice required by a registered professional engineer.

Aluminum hydraulic shoring. A pre-engineered shoring system comprised of aluminum hydraulic cylinders (crossbraces) used in conjunction with vertical rails (uprights) or horizontal rails (walers). Such system is designed specifically to support the sidewalls of an excavation and prevent cave-ins.

Bell-bottom pier hole. A type of shaft or footing excavation, the bottom of which is made larger than the cross section above to form a belled shape.

Benching (Benching system). A method of protecting employees from cave-ins by excavating the sides of an excavation to form one or a series of horizontal levels or steps usually with vertical or near vertical surfaces between levels.

Cave-in. The separation of a mass of soil or rock material from the side of an excavation, or the loss of soil from under a trench shield or support system, and its sudden movement into the excavation, either by falling or sliding, in sufficient quantity so that it could entrap, bury, or otherwise injure and immobilize a person.

Crossbraces. The horizontal members of a shoring system installed perpendicular to the sides of the excavation, the ends of which bear against either uprights or wales.

Excavation. Any man-made cut, cavity, trench, or depression in an earth surface, formed by earth removal.

Faces or sides. The vertical or inclined earth surfaces formed as a result of excavation work.

APPENDIX A

Failure. The breakage, displacement, or permanent deformation of a structural member or connection so as to reduce its structural integrity and its supportive capabilities.

Hazardous atmosphere. An atmosphere which by reason of being explosive, flammable, poisonous, corrosive, oxidizing, irritating, oxygen deficient, toxic, or otherwise harmful, may cause death, illness, or injury.

Kickout. The accidental release or failure of a cross brace.

Protective system. A method of protecting employees from cave-ins, from material that could fall or roll from an excavation face or into an excavation, or from the collapse of adjacent structures. Protective systems include support systems, sloping and benching systems, shield systems, and other systems that provide the necessary protection.

Ramp. An inclined walking or working surface that is used to gain access to one point from another, and is constructed from earth or from structural materials such as steel or wood.

Registered professional engineer. A person who is registered as a professional engineer in the state where the work is to be performed. However, a professional engineer, registered in any state is deemed to be a "registered professional engineer" within the meaning of this standard when approving designs for "manufactured protective systems" or "tabulated data" to be used in interstate commerce .

Sheeting. The members of a shoring system that retain the earth in position and in turn are supported by other members of the shoring system.

Shield (Shield system). A structure that is able to withstand the forces imposed on it by a cave-in and thereby protect employees within the structure. Shields can be permanent structures or can be designed to be portable and move along as work progresses. Additionally, shields can be either premanufactured or job-built in accordance with Section 1541.1(c)(3) or (c)(4). Shields used in trenches are usually referred to as "trench boxes" or "trench shields."

CT TRENCHING AND SHORING MANUAL

Shoring (Shoring system). A structure such as metal hydraulic, mechanical or timber shoring system that supports the sides of an excavation and which is designed to prevent cave-ins.

Sides. See "Faces."

Sloping (Sloping system). A method of protecting employees from cave-ins by excavating to form sides of an excavation that are inclined away from the excavation so as to prevent cave-ins. The angle of incline required to prevent a cave-in varies with differences in such factors as the soil type, environmental conditions of exposure, and application of surcharge loads.

Stable rock. Natural solid mineral material that can be excavated with vertical sides and will remain intact while exposed. Unstable rock is considered to be stable when the rock material on the side or sides of the excavation is secured against caving-in or movement by rock bolts or by another protective system that has been designed by a registered professional engineer.

Structural ramp. A ramp built of steel or wood, usually used for vehicle access. Ramps made of soil or rock are not considered structural ramps.

Support system. A structure such as underpinning, bracing, or shoring, which provides support to an adjacent structure, underground installation, or the sides of an excavation.

Tabulated data. Tables and charts approved by a registered professional engineer and used to design and construct a protective system.

Trench (Trench excavation). A narrow excavation (in relation to its length) made below the surface of the ground. In general, the depth is greater than the width, but the width of a trench (measured at the bottom) is not greater than 15 feet. If forms or other structures are installed or constructed in an excavation so as to reduce the dimension measured from the forms or structure to the side of the excavation to 15 feet or less, (measured at the bottom of the excavation), the excavation is also considered to be a trench.

Trench box. See "Shield."

Trench shield. See "Shield."

APPENDIX A

Uprights. The vertical members of a trench shoring system placed in contact with the earth and usually positioned so that individual members do not contact each other. Uprights placed so that individual members are closely spaced, in contact with or interconnected to each other, are often called "sheeting."

Wales. Horizontal members of a shoring system placed parallel to the excavation face whose sides bear against the vertical members of the shoring system or earth.

1541. General Requirements.

(a) Surface Encumbrances.

All surface encumbrances that are located so as to create a hazard to employees shall be supported, as necessary, to safeguard employees.

(b) Subsurface installations.

(1) The approximate location of subsurface installations, such as sewer, telephone, fuel, electric, water lines, or any other subsurface installations that reasonably may be expected to be encountered during excavation work, shall be determined by the excavator prior to opening an excavation.

(A) Excavation shall not commence until:

1. The excavation area has been marked as specified in Government Code Section 4216.2 by the excavator; and
2. The excavator has received a positive response from all known owner/operators of subsurface installations within the boundaries of the proposed project; those responses confirm that the owner/operators have located their installations, and those responses either advise the excavator of those locations or advise the excavator that the owner/operator does not operate a subsurface installation that would be affected by the proposed excavation.

(B) When the excavation is proposed within 10 feet of a high priority subsurface installation, the excavator shall be notified by the facility owner/operator of the existence of the high priority subsurface installation before the legal excavation start date and time in accordance with

CT TRENCHING AND SHORING MANUAL

Government Code Section 4216.2(a), and an onsite meeting involving the excavator and the subsurface installation owner/operator's representative shall be scheduled by the excavator and the owner/operator at a mutually agreed on time to determine the action or activities required to verify the location of such installations. High priority subsurface installations are high pressure natural gas pipelines with normal operating pressures greater than 415 kPA gauge (60 p.s.i.g.), petroleum pipelines, pressurized sewage pipelines, conductors or cables that have a potential to ground of 60,000 volts or more, or hazardous materials pipelines that are potentially hazardous to employees, or the public, if damaged.

- (C) Only qualified persons shall perform subsurface installation locating activities, and all such activities shall be performed in accordance with this section and Government Code Sections 4216 through 4216.9. Persons who complete a training program in accordance with the requirements of Section 1509, Injury and Illness Prevention Program (IIPP), that meets the minimum training guidelines and practices of the Common Ground Alliance (CGA) Best Practices, Version 3.0, published March 2006, or the standards of the National Utility Locating Contractors Association (NULCA), Standard 101: Professional Competence Standards for Locating Technicians, 2001, First Edition, which are incorporated by reference, shall be deemed qualified for the purpose of this section.
 - (D) Employees who are involved in the excavation operation and exposed to excavation operation hazards shall be trained in the excavator notification and excavation practices required by this section and Government Code Sections 4216 through 4216.9.
- (2) All Regional Notification Centers as defined by Government Code Section 4216(j) in the area involved and all known owners of subsurface facilities in the area who are not members of a Notification Center shall be advised of the proposed work at least 2 working days prior to the start of any digging or excavation work.

APPENDIX A

EXCEPTION: Repair work to subsurface facilities done in response to an emergency as defined in Government Code Section 4216(d).

- (3) When excavation or boring operations approach the approximate location of subsurface installations, the exact location of the installations shall be determined by safe and acceptable means that will prevent damage to the subsurface installation, as provided by Government Code Section 4216.4.
- (4) While the excavation is open, subsurface installations shall be protected, supported, or removed as necessary to safeguard employees.
- (5) An excavator discovering or causing damages to a subsurface installation shall immediately notify the facility owner/operator or contact the Regional Notification Center to obtain subsurface installation operator contact information immediately after which the excavator shall notify the facility operator. All breaks, leaks, nicks, dents, gouges, grooves, or other damages to an installation's lines, conduits, coatings or cathodic protection shall be reported to the subsurface installation operator. If damage to a high priority subsurface installation results in the escape of any flammable, toxic, or corrosive gas or liquid or endangers life, health or property, the excavator responsible shall immediately notify 911, or if 911 is unavailable, the appropriate emergency response personnel having jurisdiction. The facility owner/operator shall also be contacted.

Note: The terms excavator and operator as used in Section 1541(b) shall be as defined in Government Code Section 4216(c) and (h) respectively. The term "owner/operator" means an operator as the term "operator" is defined in Government Code Section 4216(h).

(c) Access and egress.

- (1) Structural ramps.
 - (A) Structural ramps that are used solely by employees as a means of access from excavations shall be designed by a competent person. Structural ramps used for access or egress of equipment shall be designed by a competent person qualified in structural design, and shall be constructed in accordance with the design.

CT TRENCHING AND SHORING MANUAL

- (B) Ramps and runways constructed of two or more structural members shall have the structural members connected together to prevent displacement.
 - (C) Structural members used for ramps and runways shall be of uniform thickness.
 - (D) Cleats or other appropriate means used to connect runway structural members shall be attached to the bottom of the runway or shall be attached in a manner to prevent tripping.
 - (E) Structural ramps used in lieu of steps shall be provided with cleats or other surface treatments to the top surface to prevent slipping.
- (2) Means of egress from trench excavations.
- A stairway, ladder, ramp or other safe means of egress shall be located in trench excavations that are 4 feet or more in depth so as to require no more than 25 feet of lateral travel for employees.

(d) Exposure to vehicular traffic.

Employees exposed to public vehicular traffic shall be provided with, and shall wear warning vests or other suitable garments marked with or made of reflectorized or high-visibility material.

(e) Exposure to falling loads.

No employee shall be permitted underneath loads handled by lifting or digging equipment. Employees shall be required to stand away from any vehicle being loaded or unloaded to avoid being struck by any spillage or falling materials. Operators may remain in the cabs of vehicles being loaded or unloaded when the vehicles are equipped, in accordance with Section 1591(e), to provide adequate protection for the operator during loading and unloading operations.

(f) Warning system for mobile equipment.

When mobile equipment is operated adjacent to an excavation, or when such equipment is required to approach the edge of an excavation, and the operator does not have a clear and direct view of the edge of the excavation, a warning system shall be utilized such as barricades, hand or mechanical signals or stop logs. If possible the grade should be away from the excavation.

(g) Hazardous atmospheres.

APPENDIX A

(1) Testing and controls.

In addition to the requirements set forth in the Construction Safety Orders and the General Industry Safety Orders to prevent exposure to harmful levels of atmospheric contaminants, the following requirements shall apply:

- (A) Where oxygen deficiency (atmospheres containing less than 19.5 percent oxygen) or a hazardous atmosphere exists or could reasonably be expected to exist, such as in excavations in landfill areas or excavations in areas where hazardous substances are stored nearby, the atmospheres in the excavation shall be tested before employees enter excavations greater than 4 feet in depth.
- (B) Adequate precautions shall be taken to prevent employee exposure to atmospheres containing less than 19.5 percent oxygen and other hazardous atmospheres. These precautions include providing proper respiratory protection or ventilation.
- (C) Adequate protection shall be taken such as providing ventilation, to prevent employee's exposure to an atmosphere containing a concentration of a flammable gas in excess of 20 percent of the lower flammable limit of the gas.
- (D) When controls are used that are intended to reduce the level of atmospheric contaminants to acceptable levels, testing shall be conducted as often as necessary to ensure that the atmosphere remains safe.

(2) Emergency rescue equipment.

- (A) Emergency rescue equipment, such as breathing apparatus, a safety harness and line, or a basket stretcher shall be readily available where hazardous atmospheric conditions exist or may reasonably be expected to develop during work in an excavation. This equipment shall be attended when in use.
- (B) Employees entering bell-bottom pier holes, or other similar deep and confined footing excavations, shall wear a harness with a lifeline securely attached to it. The lifeline shall be separate from any line used

to handle material, and shall be individually attended at all times while the employee wearing the lifeline is in the excavation.

(h) Protection from hazards associated with water accumulation.

- (1) Employees shall not work in excavations in which there is accumulated water, or in excavations in which water is accumulating, unless adequate precautions have been taken to protect employees against the hazards posed by water accumulation. The precautions necessary to protect employees adequately vary with each situation, but could include special support or shield systems to protect from cave-ins, water removal to control the level of accumulating water, or use of a safety harness and lifeline.
- (2) If water is controlled or prevented from accumulating by the use of water removal equipment, the water removal equipment and operations shall be monitored by a competent person to ensure proper operation.
- (3) If excavation work interrupts the natural drainage of surface water (such as streams), diversion ditches, dikes, or other suitable means shall be used to prevent surface water from entering the excavation and to provide adequate drainage of the area adjacent to the excavation. Excavations subject of runoff from heavy rains will require an inspection by a competent person and compliance with Sections 1541(h) (1) and (h) (2).

(i) Stability of adjacent structures.

- (1) Where the stability of adjoining buildings, walls, or other structures is endangered by excavation operations, support system such as shoring, bracing, or underpinning shall be provided to ensure the stability of such structures for the protection of employees.
- (2) Excavation below the level of the base or footing of any foundation or retaining wall that could be reasonably expected to pose a hazard to employees shall not be permitted except when:
 - (A) A support system, such as underpinning, is provided to ensure the safety of employees and the stability of the structure; or
 - (B) The excavation is in stable rock; or

APPENDIX A

(C) A registered professional engineer has approved the determination that such excavation work will not pose as hazard to employees.

- (3) Sidewalks, pavements and appurtenant structures shall not be undermined unless a support system or another method of protection is provided to protect employees from the possible collapse of such structures.

(j) Protection of employees from loose rock or soil.

- (1) Adequate protection shall be provided to protect employees from loose rock or soil that could pose a hazard by falling or rolling from an excavation face. Such protection shall consist of scaling to remove loose material; installation of protective barricades at intervals as necessary on the face to stop and contain falling material; or other means that provide equivalent protection.
- (2) Employees shall be protected from excavated or other materials or equipment that could pose a hazard by falling or rolling into excavations. Protection shall be provided by placing and keeping such materials or equipment at least 2 feet from the edge of excavations, or by the use of retaining devices that are sufficient to prevent materials or equipment from falling or rolling into excavations, or by a combination of both if necessary.

(k) Inspections.

- (1) Daily inspections of excavations, the adjacent areas, and protective systems shall be made by a competent person for evidence of a situation that could result in possible cave-ins, indications of failure of protective systems, hazardous atmospheres, or other hazardous conditions. An inspection shall be conducted by the competent person prior to the start of work and as needed throughout the shift. Inspections shall also be made after every rain storm or other hazard increasing occurrence. These inspections are only required when employee exposure can be reasonably anticipated.
- (2) Where the competent, person finds evidence of a situation that could result in a possible cave-in, indications of failure of protective systems, hazardous atmospheres, or other hazardous conditions, exposed employees shall be removed from the hazardous area until the necessary precautions have been taken to ensure their safety.

(l) Fall protection.

- (1) Where employees or equipment are required or permitted to cross over excavations over 6-feet in depth and wider than 30 inches, walkways or bridges with standard guardrails shall be provided.
- (2) Adequate barrier physical protection shall be provided at all remotely located excavations. All wells, pits, shafts, etc., shall be barricaded or covered. Upon completion of exploration and other similar operations, temporary wells, pits, shafts, etc., shall be backfilled.

1541.1 Requirements For Protective Systems.

(a) Protection of employees in excavations.

- (1) Each employee in an excavation shall be protected from cave-ins by an adequate protective system designed in accordance with Section 1541.1(b) or (c) except when:
 - (A) Excavations are made entirely in rock; or
 - (B) Excavations are less than 5 feet in depth and examination of the ground by a competent person provides no indication-of potential cave-in.
- (2) Protective systems shall have the capacity to resist without failure all loads that are intended or could reasonably be expected to be applied or transmitted to the system.

(b) Design of sloping and benching systems.

The slopes and configurations of sloping and benching systems shall be selected and constructed by the employer or his designee and shall be in accordance with the requirements of Section 1541.1(b)(1), Section 1541.1(b)(2), Section 1541.1(b)(3), or Section 1541.1(b)(4), as follows:

- (1) Option (1) - Allowable configurations and slopes,
 - (A) Excavations shall be sloped at an angle not steeper than one and one-half horizontal to one vertical (34 degrees measured from the horizontal), unless the employer uses one of the options listed below:

APPENDIX A

- (B) Slopes specified in Section 1541.1(b) (1) (A) shall be excavated to form configurations that are in accordance with the slopes shown for Type C soil in Appendix B to this article.
- (2) Option (2) - Determination of slopes and configurations using Appendices A and B. Maximum allowable slopes, and allowable configurations for sloping and benching systems, shall be determined in accordance with the conditions and requirements set forth in Appendices A and B to this article.
- (3) Option (3) - Designs using other tabulated data.
 - (A) Designs of sloping or benching systems shall be selected from and be in accordance with tabulated data, such as tables and charts.
 - (B) The tabulated data shall be in written form and shall include all of the following:
 1. Identification of the parameters that affect the selection of a sloping or benching system drawn from such data.
 2. Identification of the limits of use of the data, to include the magnitude and configuration of slopes determined to be safe.
 3. Explanatory information as may be necessary to aid the user in making a correct selection of a protective system from the data.
 4. At least one copy of the tabulated data which identifies the registered professional engineer who approved the data, shall be maintained at the jobsite during construction of the protective system. After that time the data may be stored off the jobsite, but a copy of the data shall be made to the Division upon request.
- (4) Option (4) - Design by a registered professional engineer.
 - (A) Sloping and benching systems not utilizing option (1) or option (2) or Option (3) under Section 1541.1(b) shall be stamped and signed by a registered professional engineer.
 - (B) Designs shall be in written form and shall include at least the following:

The magnitude of the slopes that were determined to be safe for the particular project;

2. The configuration's that were determined to be safe for the particular project;
3. The identity of the registered professional engineer approving the design.

(C) At least one copy of the design shall be maintained at the jobsite while the slope is being constructed. After that time the design need not be at the jobsite, but a copy shall be made available to the Division upon request.

(c) Design of support systems, shield systems, and other protective systems.

Designs of support systems, shield systems, and other protective systems shall be selected and constructed by the employer or his designee and shall be in accordance with the requirements of Section 1541.1(c) (1); or, in the alternative, Section 1541.1(c) (2); or, in the alternative Section 1541.1(c) (3); or, in the alternative Section 1541.1(c) (4) as follows:

(1) Option (1) - Designs using Appendices A, C, and D. Designs for timber shoring in trenches shall be determined in accordance with the conditions and requirements set forth in Appendices A and C to this article. Designs for aluminum hydraulic shoring shall be in accordance with Section 1541.1(c) (2), but if manufacturer's tabulated data cannot be utilized, designs shall be in accordance with Appendix D.

(2) Option (2) - Designs using manufacturers Tabulated Data

(A) Design of support systems, shield systems, or other protective systems that are drawn from manufacturer's tabulated data shall be in accordance with all recommendations, and limitations issued or made by the manufacturer.

(B) Deviation from the specifications, recommendations, and limitations issued or made by the manufacturer shall only be allowed after the manufacturer issues specific written approval.

(C) Manufacturer's specifications, recommendations, and limitations, and manufacturer's approval to deviate from the specifications, recommendations, and limitations shall be in written form at the jobsite

APPENDIX A

during construction of the protective system. After that time this data may be stored off the jobsite, but a copy shall be made available to the Division upon request.

(3) Option (3) - Designs using other tabulated data.

- (A) Designs of support systems, shield systems, or other protective systems shall be selected from and be in accordance with tabulated data, such as tables and charts.
- (B) The tabulated data shall be in written form and include all of the following:
 - 1. Identification of the parameters that affect the selection of a protective system drawn from such data;
 - 2. Identification of the limits of use of the data;
 - 3. Explanatory information as may be necessary to aid the user. in making a correct selection of a protective system from the data.
- (C) At least one copy of the tabulated data, which identifies the registered professional engineer who approved the data, shall be maintained at the jobsite during construction of the protective system. After that time the data may be stored off the jobsite, but a copy of the data shall be made available to the Division on request.

(4) Option (4) - Design by a registered professional engineer.

- (A) Support systems, shield systems, and other protective systems not utilizing Option 1, Option 2, or Option 3 above, shall be approved by a registered professional engineer.
- (B) Designs shall be in written form and shall include the following:
 - 1. A plan indicating the sizes, types, and configurations of the materials to be used in the protective system; and
 - 2. The identity of the registered professional engineer approving the design.
- (C) At least one copy of the design shall be maintained at the jobsite during construction of the protective system. After that time, the design may be

stored off the jobsite, but a copy of the design shall be made available to the Division upon request.

(d) Materials and equipment.

- (1) Materials and equipment used for protective systems shall be free from damage or defects that might impair their proper function.
- (2) Manufactured materials and equipment used for protective systems shall be used and maintained in a manner that is consistent with the recommendations of the manufacturer, and in a manner that will prevent employee exposure to hazards.
- (3) When material or equipment that is used for protective systems is damaged, a competent person shall examine the material or equipment and evaluate its suitability for continued use. If the competent person cannot assure the material or equipment is able to support the intended loads or is otherwise suitable for safe use, then such material or equipment shall be removed from service, and shall be evaluated and approved by a registered professional engineer before being returned to service.

(e) Installation and removal of supports.

(l) General.

- (A) Members of support systems shall be securely connected together to prevent sliding, falling, kickouts, or other predictable failure.
- (B) Support systems shall be installed and removed in a manner that protects employees from cave-ins, structural collapses, or from being struck by members of the support system.
- (C) Individual members of support systems shall not be subjected to loads exceeding those which those members were designed to withstand.
- (D) Before temporary removal of individual members begins, additional precautions shall be taken to ensure the safety of employees, such as installing other structural members to carry the load imposed on the support system.
- (E) Removal shall begin at, and progress from, the bottom of the excavation. Members shall be released slowly so as to note any indication of

APPENDIX A

possible failure of the remaining members of the structure or possible cave-in of the sides of the excavation.

- (F) Backfilling shall progress together with the removal of support systems from excavations.

(2) Additional requirements for support systems for trench excavations.

- (A) Excavations of material to a level no greater than 2 feet below the bottom of the members of a support system shall be permitted, but only if the system is designed to resist the forces calculated for the full depth of the trench, and there are no indications while the trench is open of a possible loss of soil from behind or below the bottom of the support system.
- (B) Installation of a support system shall be closely coordinated with the excavation of trenches.

(f) Sloping and benching systems.

Employees shall not be permitted to work on the faces of sloped or benched excavations at levels above other employees except when employees at the lower levels are adequately protected from the hazards of falling, rolling, or sliding material or equipment.

(g) Shield systems.

(1) General.

- (A) Shield systems shall not be subjected to loads exceeding those which the system was designed to withstand.
- (B) Shields shall be installed in a manner to restrict lateral or other hazardous movement of the shield in the event of the application of sudden lateral loads.
- (C) Employees shall be protected from the hazard of cave-ins when entering or exiting the areas protected by the shields.
- (D) Employees shall not be allowed in shields when shields are being installed, or moved vertically.

- (2) Additional requirements for shield systems used in trench excavations. The sides of the shield shall extend a minimum of 18 inches above the vertical walls

CT TRENCHING AND SHORING MANUAL

of compound excavations as shown in Appendix B, figures B-1, B-1.2 and B-1.3. On vertically cut trenches, the shield shall extend to at least the catch point of the trench. Excavations of earth material to a level not greater than 2 feet below the bottom of a shield shall be permitted, but only if the shield is designed to resist the forces calculated for the full depth of the trench, and there are no indications while the trench is open of a possible loss of soil from behind or below the bottom of the shield.

- (h) Uprights shall extend to the top of the trench with the lower end of the upright not more than 2 feet from the bottom of the trench**

Appendix A to Section 1541.1

SOIL CLASSIFICATION

(a) Scope and application.

- (1) Scope. This appendix describes a method of classifying soil and deposits based on site and environmental conditions, and on the structure and composition of the earth deposits. The appendix contains definitions, sets forth requirements, and describes acceptable visual and manual tests for use in classifying soils.
- (2) Application. This appendix applies when a sloping or benching system is designed in accordance with the requirements set forth in Section 1541.1(b)(2) as a method of protection for employees from cave-ins. This appendix also applies when timber shoring for excavations is designed as a method of protection from cave-ins in accordance with Appendix C of this article, and when aluminum hydraulic shoring is designed in accordance with Appendix D. This appendix also applies if other protective systems are designed and selected for use from data prepared in accordance with the requirements set forth in Section 1541.1(c), and the use of the data is predicated on the use of the soil classification system set forth in this appendix.

(b) Definitions.

Cemented soil. A soil in which the particles are held together by a chemical agent, such as calcium carbonate, such that a hand-size sample cannot be crushed into powder or individual soil particles by finger pressure.

Cohesive soil. Clay (fine grained soil), or soil with a high clay content, which has cohesive strength. Cohesive soil does not crumble, can be excavated with vertical side slopes, and is plastic when moist. Cohesive soil is hard to break up when dry, and exhibits significant cohesion when submerged. Cohesive soils include clayey silt, sandy clay, silty clay, clay and organic clay.

Dry soil. Soil that does not exhibit visible signs of moisture content.

Fissured. A soil material that has a tendency to break along definite planes of fracture with little resistance, or a material that exhibits open cracks, such as tension cracks, in an exposed surface.

CT TRENCHING AND SHORING MANUAL

Granular soil. Gravel, sand, or silt (coarse grained soil) with little or no clay content.

Granular soil has no cohesive strength. Some moist granular soils exhibit apparent cohesion. Granular soil cannot be molded when moist and crumbles easily when dry.

Layered system. Two or more distinctly different soil or rock types arranged in layers. Micaceous seams or weakened planes in rock or shale are considered layered.

Moist soil. A condition in which a soil looks and feels damp. Moist cohesive soil can easily be shaped into a ball and rolled into small diameter threads before crumbling. Moist granular soil that contains some cohesive material will exhibit some signs of cohesion between particles.

Plastic. A property of a soil which allows the soil to be deformed or molded without cracking, or appreciable volume change.

Saturated soil. A soil in which the voids are filled with water. Saturation does not require flow. Saturation, or near saturation, is necessary for the proper use of instruments such as a pocket penetrometer or shear vane.

Soil classification system. A method of categorizing soil and rock deposits in a hierarchy of Stable Rock, Type A, Type B, and Type C, in decreasing order of stability. The categories are determined based on an analysis of the properties and performance characteristics of the deposits and the characteristics of the deposits and the environmental conditions of exposure.

Stable rock. Natural solid mineral matter that can be excavated with vertical sides and remain intact while exposed.

Submerged soil. Soil which is underwater or is free seeping.

Type A soil.

Cohesive soils with an unconfined compressive strength of 1.5 tons per square foot (tsf) or greater. Examples of cohesive-soils are: clay, silty clay, sandy clay, clay loam and, in some cases, silty clay loam and sandy clay loam. Cemented soils such as caliche and hardpan are also considered Type A. However, no soil is Type A if:

- (1) The soil is fissured; or

APPENDIX A

- (2) The soil is subject to vibration from heavy traffic, pile driving, or similar effects; or
- (3) The soil has been previously disturbed; or
- (4) The soil is part of a sloped, layered system where the layers dip into the excavation on a slope of four horizontal to one vertical (4H:1V) or greater; or
- (5) The material is subject to other factors that would require it to be classified as a less stable material.

Type B soil.

- (1) Cohesive soil with an unconfined compressive strength greater than 0.5 tsf but less than 1.5 tsf; or
- (2) Granular cohesionless soils including: angular gravel (similar to crushed rock), silt, silt loam, sandy loam and, in some cases, silty clay loam and sandy clay loam.
- (3) Previously disturbed soils except those which would otherwise be classified as Type C soil.
- (4) Soil that meets the unconfined compressive strength or cementation requirements for Type A, but is fissured or subject to vibration; or
- (5) Dry rock that is not stable; or
- (6) Material that is part of a sloped, layered system where the layers dip into the excavation on a slope less steep than four horizontal to one vertical (4H:1V), but only if the material would otherwise be classified as Type B.

Type C soil.

- (1) Cohesive soil with an unconfined compressive strength of 0.5 tsf or less; or
- (2) Granular soils including gravel, sand, and loamy sand; or
- (3) Submerged soil or soil from which water is freely seeping; or
- (4) Submerged rock that is not stable, or

CT TRENCHING AND SHORING MANUAL

- (5) Material in a sloped, layered system where the layers dip into the excavation or a slope of four horizontal to one vertical (4H:1V) or steeper.

Unconfined compressive strength. The load per unit area at which a soil will fail in compression. It can be determined by laboratory testing, or estimated in the field using a pocket penetrometer, by thumb penetration tests, and other methods.

Wet soil. Soil that contains significantly more moisture than moist soil, but in such a range of values that cohesive material will slump or begin to flow when vibrated. Granular material that would exhibit cohesive properties when moist will lose those cohesive properties when wet.

(c) Requirements.

- (1) Classification of soil and rock deposits. Each soil and rock deposit shall be classified by a competent person as Stable Rock, Type A, Type B, Type C in accordance with the definitions set forth in paragraph (b) of this appendix.
- (2) Basis of classification. The classification of the deposits shall be made based on the results of at least one visual and at least one manual analysis. Such analysis shall be conducted by a competent person using tests described in paragraph (d) below, or in other approved methods of soil classification and testing such as those adopted by the American Society for Testing Materials, or the U.S. Department of Agriculture textural classification system.
- (3) Visual and manual analysis. The visual and manual analysis, such as those noted as being acceptable in paragraph (d) of this appendix, shall be designed and conducted to provide sufficient quantitative and qualitative information as may be necessary to identify properly the properties, factors, and conditions affecting the classification of the deposits.
- (4) Layered systems. In a layered system, the system shall be classified in accordance with its weakest layer. However, each layer may be classified individually where a more stable layer lies under a less stable layer.
- (5) Reclassification. If, after classifying a deposit, the properties, factors, or conditions affecting its classification change in any way, the changes shall be

APPENDIX A

evaluated by a competent person. The deposit shall be reclassified as necessary to reflect the changed circumstances.

(d) Acceptable visual and manual tests.

- (1) Visual tests. Visual analysis is conducted to determine qualitative information regarding the excavation site in general the soil adjacent to the excavation, the soil forming the sides of the open excavation, and the soil taken as samples from excavated material.
 - (A) Observe samples of soil that are excavated and soil in the sides of the excavation. Estimate the range of particle sizes and the relative amounts of the particle sizes. Soil that is primarily composed of fine-grained material is cohesive material. Soil composed primarily of coarse grained sand or gravel is granular material.
 - (B) Observe soil as it is excavated. Soil that remains in clumps when excavated is cohesive. Soil that breaks up easily and does not stay in clumps is granular.
 - (C) Observe the side of the opened excavation and the surface area adjacent to the excavation. Crack-like openings such as tension cracks could indicate fissured material. If chunks of soil spall off a vertical side, the soil could be fissured. Small spalls are evidence of moving ground and are indications of potentially hazardous situations.
 - (D) Observe the area adjacent to the excavation and the excavation itself for evidence of existing utility and other underground structures, and to identify previously disturbed soil.
 - (E) Observe the opened side of the excavation to identify layered systems. Examine layered systems to identify if the layers slope toward the excavation. Estimate the degree of slope of the layers.
 - (F) Observe the area adjacent to the excavation and the sides of the opened excavation for evidence of surface water, water seeping from the sides of the excavation, or the location of the level of the water table.

CT TRENCHING AND SHORING MANUAL

- (G) Observe the area adjacent to the excavation and the area within the excavation for sources of vibration that may affect the stability of the excavation face.
- (2) Manual tests. Manual analysis of soil samples is conducted to determine quantitative as well as qualitative properties of soil and to provide more information in-order to classify soil properly.
- (A) Plasticity. Mold a moist or wet sample of soil into a ball and attempt to roll it into threads as thin as 1/8-inch in diameter. Cohesive material can be successfully rolled into threads without crumbling. For example, if at least a two inch length of 1/8-inch thread can be held on one end without tearing, the soil is cohesive.
 - (B) Dry strength. If the soil is dry and crumbles on its own or with moderate pressure into individual grains or fine powder, it is granular (any combination of gravel, sand, or silt). If the soil is dry and falls into clumps which break up into smaller clumps, but the smaller clumps can only be broken up with difficulty, it may be clay in any combination with gravel, sand or silt. If the dry soil breaks into clumps which do not break up into small clumps and which can only be broken with difficulty, and there is no visual indication the soil is fissured, the soil may be considered unfissured.
 - (C) Thumb penetration. The thumb penetration test can be used to estimate the unconfined compressive strength of cohesive soils. Type A soils with an unconfined compressive strength of 1.5 tsf can be readily indented by the thumb; however, they can be penetrated by the thumb only with very great effort. Type C soils with an unconfined compressive strength of 0.5 tsf can be easily penetrated several inches by the thumb, and can be molded by light finger pressure. This test should be conducted on an undisturbed soil sample, such as a large clump of soil, as soon as practicable after excavation to keep to a minimum the effects of exposure to drying influences. If the excavation is later exposed to wetting influences

APPENDIX A

(rain, flooding), the classification of the soil must be changed accordingly.

- (D) Other strength tests. Estimates of unconfined compressive strength of soils can also be obtained by use of a pocket penetrometer or by using a hand-operated shear vane.
- (E) Drying test. The basic purpose of the drying test is to differentiate between cohesive material with fissures, unfissured cohesive material, and granular material. The procedure for the drying test involves drying a sample of soil that is approximately one inch thick and six inches in diameter until it is thoroughly dry:
 1. If the sample develops cracks as it dries, significant fissures are indicated.
 2. Samples that dry without cracking are to be broken by hand. If considerable force is necessary to break a sample, the soil has significant cohesive material content. The soil can be classified as an unfissured cohesive material and the unconfined compressive strength should be determined.
 3. If a sample breaks easily by hand, it is either a fissured cohesive material or a granular material. To distinguish between the two, pulverize the dried clumps of the sample by hand or by stepping on them. If the clumps do not pulverize easily, the material is cohesive with fissures. If they pulverize easily into very small fragments, the material is granular.

Appendix B to Section 1541.1

SLOPING AND BENCHING

(a) Scope and application.

This appendix contains specifications for sloping and benching when used as methods of protecting employees working in excavations from cave-ins. The requirements of this appendix apply when the design of sloping and benching protective systems is to be performed in accordance with the requirements set forth in Section 1541.1 (b).

(b) Definitions.

Actual slope means the slope to which an excavation face is excavated.

Distress means that the soil is in a condition where a cave-in is imminent or is likely to occur. Distress is evidenced by such phenomena as the development of fissures in the face of or adjacent to an open excavation; the subsidence of the edge of an excavation; the slumping of material from the face or the bulging or heaving of material from the bottom of an excavation; the spalling of material from the face of an excavation; and raveling, i.e., small amounts of material such as pebbles or little clumps of material suddenly separating from the face of an excavation and trickling or rolling down into the excavation .

Maximum allowable slope means the steepest incline of an excavation face that is acceptable for the most favorable site conditions as protection against cave-ins, and is expressed as the ratio of horizontal distance to vertical rise (H:V).

Short term exposure means a period of time less than or equal to 24 hours that an excavation is open.

(c) Requirements.

- (1) Soil classification. Soil and rock deposits shall be classified in accordance with Appendix A to Section 1541.1.
- (2) Maximum allowable slope. The maximum allowable slope for a soil or rock deposit shall be determined from Table B-1 of this appendix.
- (3) Actual slope.

APPENDIX A

- (A) The actual slope shall not be steeper than the maximum allowable slope.
 - (B) The actual slope shall be less steep than the maximum allowable slope when there are signs of distress. If that situation occurs, the slope shall be cut back to an actual slope which is at least 1/2 horizontal to one vertical (1/2H:1V) less steep than the maximum allowable slope.
 - (C) When surcharge loads from stored material or equipment, operating equipment, or traffic are present, a competent person "shall determine the degree to which the actual slope must be reduced below the maximum allowable slope, and shall assure that such reduction is achieved. Surcharge loads from adjacent structures shall be evaluated in accordance with Section 1541(i).
- (4) Configurations. Configurations of sloping and benching systems shall be in accordance with Figure B-1.

TABLE B-1	
MAXIMUM ALLOWABLE SLOPES	
SOIL OR ROCK TYPE	MAXIMUM ALLOWABLE SLOPES (H:V) ¹ FOR EXCAVATIONS LESS THAN 20 FEET DEEP ³
STABLE ROCK	VERTICAL. (90°)
TYPE A ²	3/4:1 (53°)
TYPE B	1:1 (45°)
TYPE C	1 1/2:1 (34°)

NOTES:

1. Numbers shown in parentheses next to maximum allowable slopes are angles expressed in degrees from the horizontal. Angles have been rounded off.
2. A short-term maximum allowable slope of 1/2H:1V (63 degrees) is allowed in excavations in Type A soil that are 12 feet or less in depth. Short term maximum allowable slopes for excavations greater than 12 feet in depth shall be 3/4H:1V (53 degrees).
3. Sloping or benching for excavations greater than 20 feet deep shall be designed by a registered professional engineer.

FIGURE B-1

SLOPE CONFIGURATIONS

(All slopes stated below are in the horizontal to vertical ratio).

B-1.1 Excavations Made in Type A soil.

1. All simple slope excavations 20 feet or less in depth shall have a maximum allowable slope of 3/4:1.

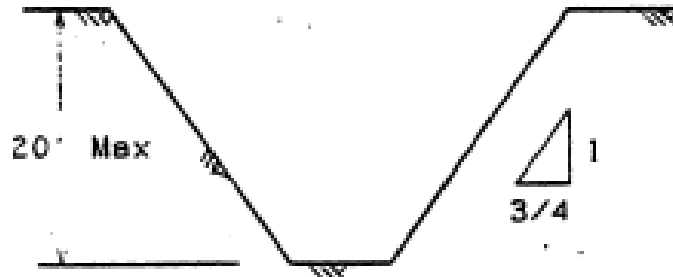

Simple Slope - General

Exception: Simple slope excavations which are open 24 hours or less (short term) and which are 12 feet or less in depth shall have a maximum allowable slope of 1/2:1.

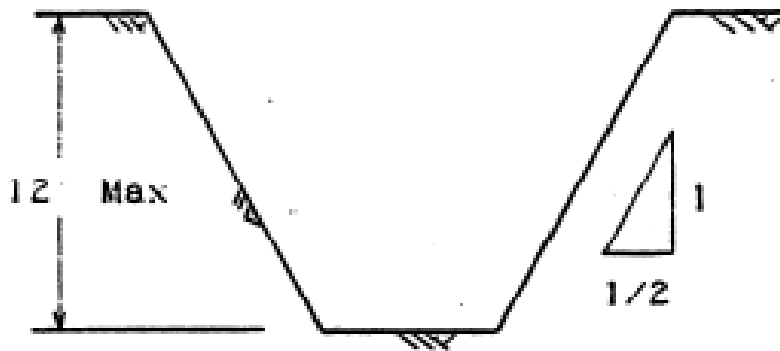

Simple Slope - Short Term

2. All benched excavations 20 feet or less in depth shall have a maximum allowable slope of 3/4:1 and maximum bench dimensions as follows:

APPENDIX A

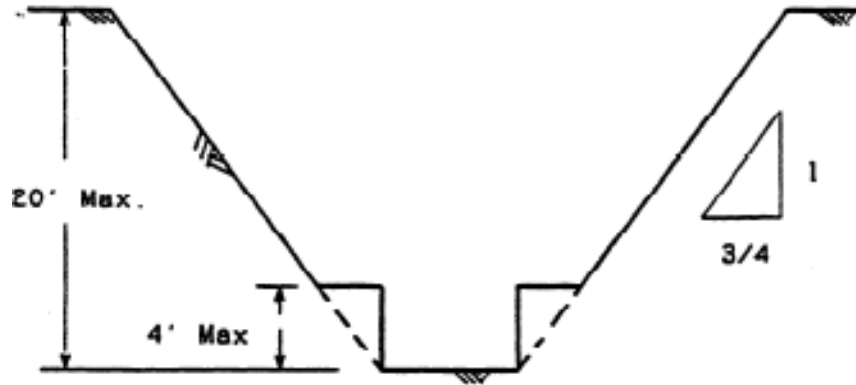

Simple Bench

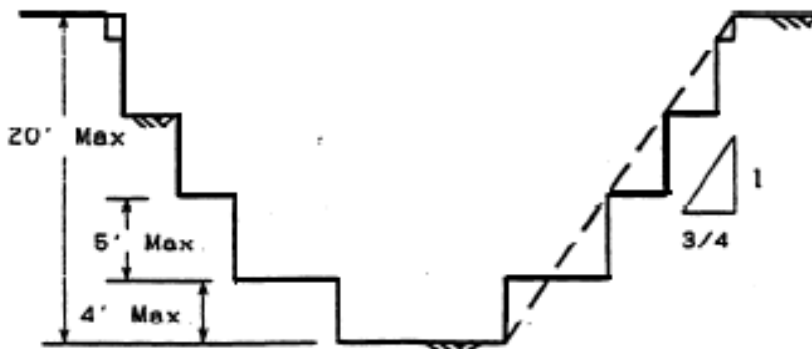

Multiple Bench

3. All excavations 8 feet or less in depth which have unsupported vertically sided lower portions shall have a maximum vertical side of 3 1/2 feet.



Unsupported Vertically Sided Lower Portion

Maximum 8 Feet in Depth

All excavations more than 8 feet but not more than 12 feet in depth with unsupported vertically sided lower portions shall have a maximum allowable slope of 1:1 and a maximum vertical side of 3 1/2 feet.

CT TRENCHING AND SHORING MANUAL

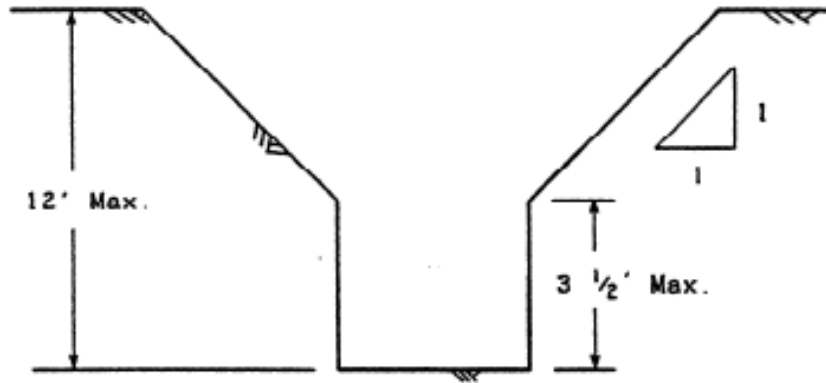

Unsupported Vertically Sided Lower Portion
Maximum 12 Feet in Depth

All excavations 20 feet or less in depth which have vertically sided lower portions that are supported or shielded shall have a maximum allowable slope of 3/4:1. The support or shield system must extend at least 18 inches above the top of the vertical side.

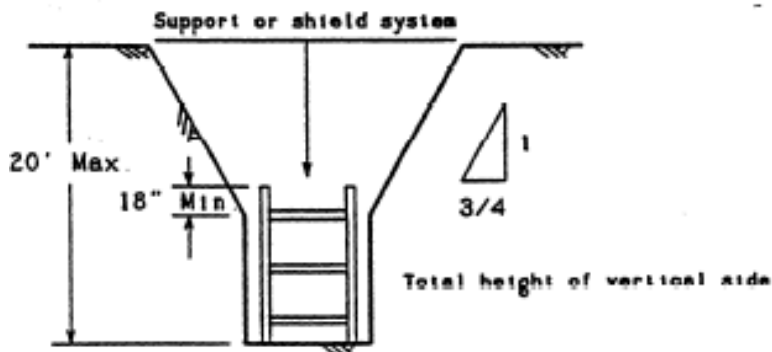

Supported or Shielded Vertically Sided Lower Portion

B- 1.2 Excavations Made in Type B Soil

1. All simple slope excavations 20 feet or less in depth shall have a maximum allowable slope of 1:1.

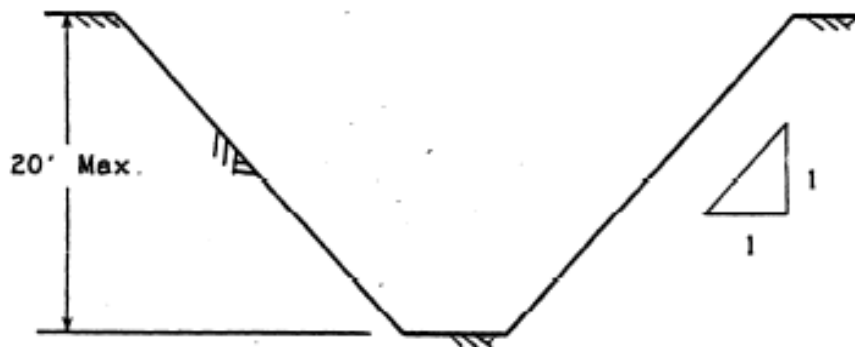

Simple Slope

APPENDIX A

- 2 All benched excavations 20 feet or less in depth shall have a maximum allowable slope of 1:1 and maximum bench dimensions as follows:

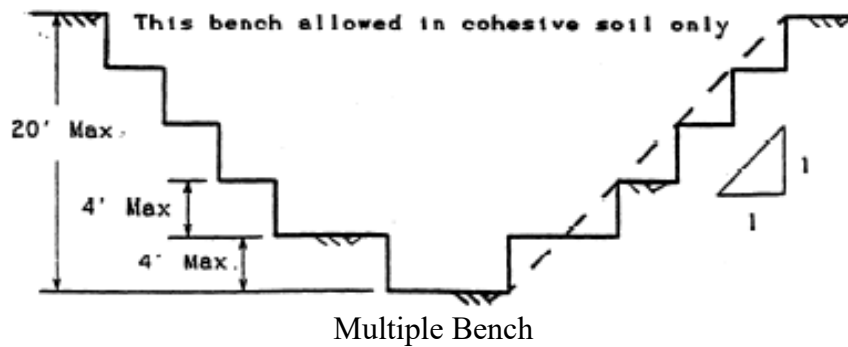
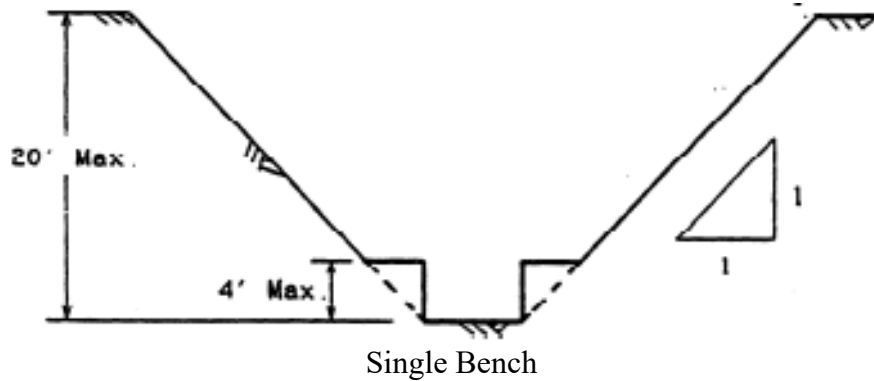

3. All excavations 20 feet or less in depth which have vertically sided lower portions shall be shielded or supported to a height at least 18 inches above the top of the vertical side. All such excavations shall have a maximum allowable slope of 1:1.

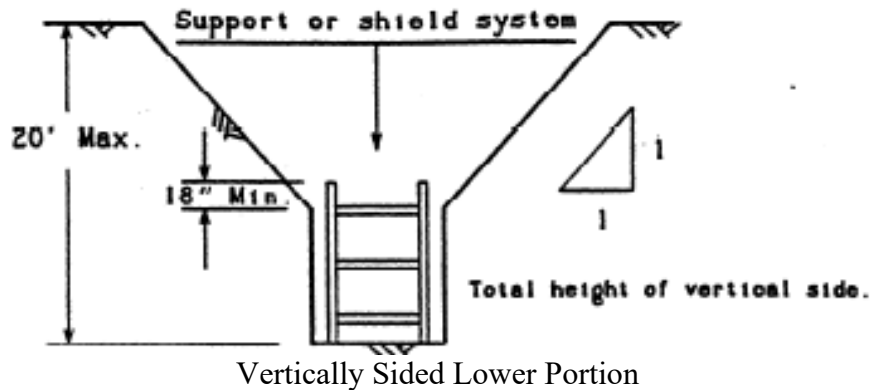

B - 1.3 Excavations Made in Type C Soil

1. All simple slope excavations 20 feet or less in depth shall have a maximum allowable slope of 1 1/2:1.

CT TRENCHING AND SHORING MANUAL

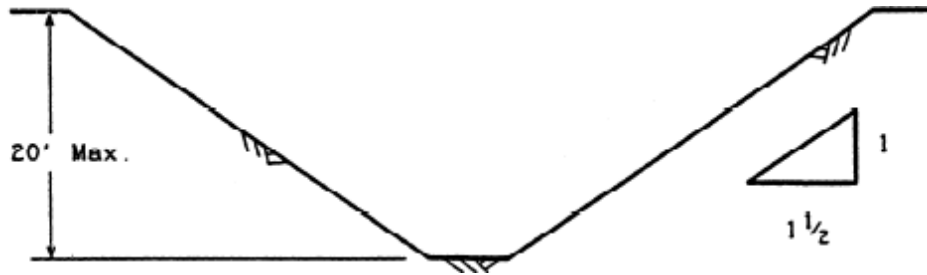

Simple Slope

2. All excavations 20 feet or less in depth which have vertically sided lower portions shall be shielded or supported to a height at least 18 inches above the top of the vertical side. All such excavations shall have a maximum allowable slope of 1½:1.

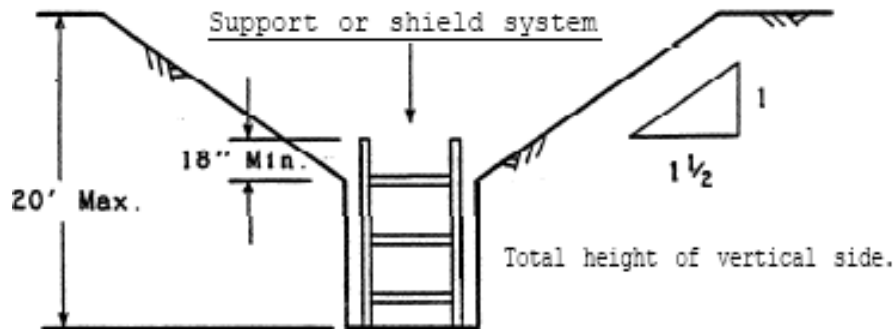

Vertical Sided Lower Portion

3. All other sloped excavations shall be in accordance with the other options permitted in 1541.1(b).

B - 1.4 Excavations Made in Layered Soils

1. All excavations 20 feet or less in depth made in layered soils shall have a maximum allowable slope for each layer as set forth below:

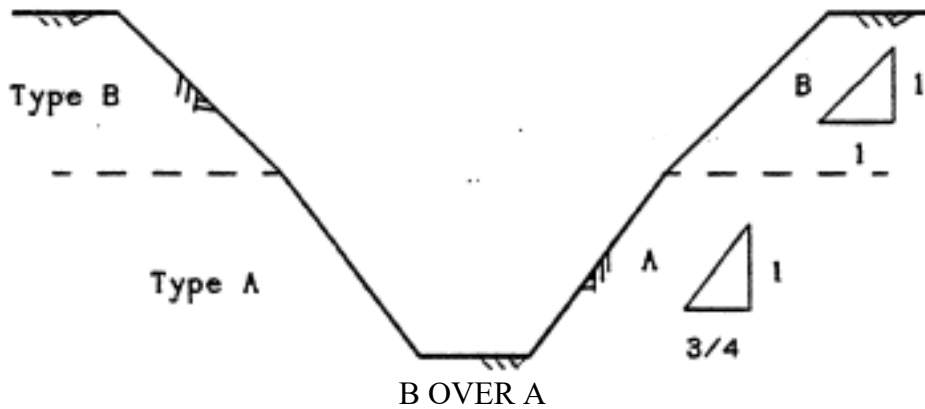

APPENDIX A

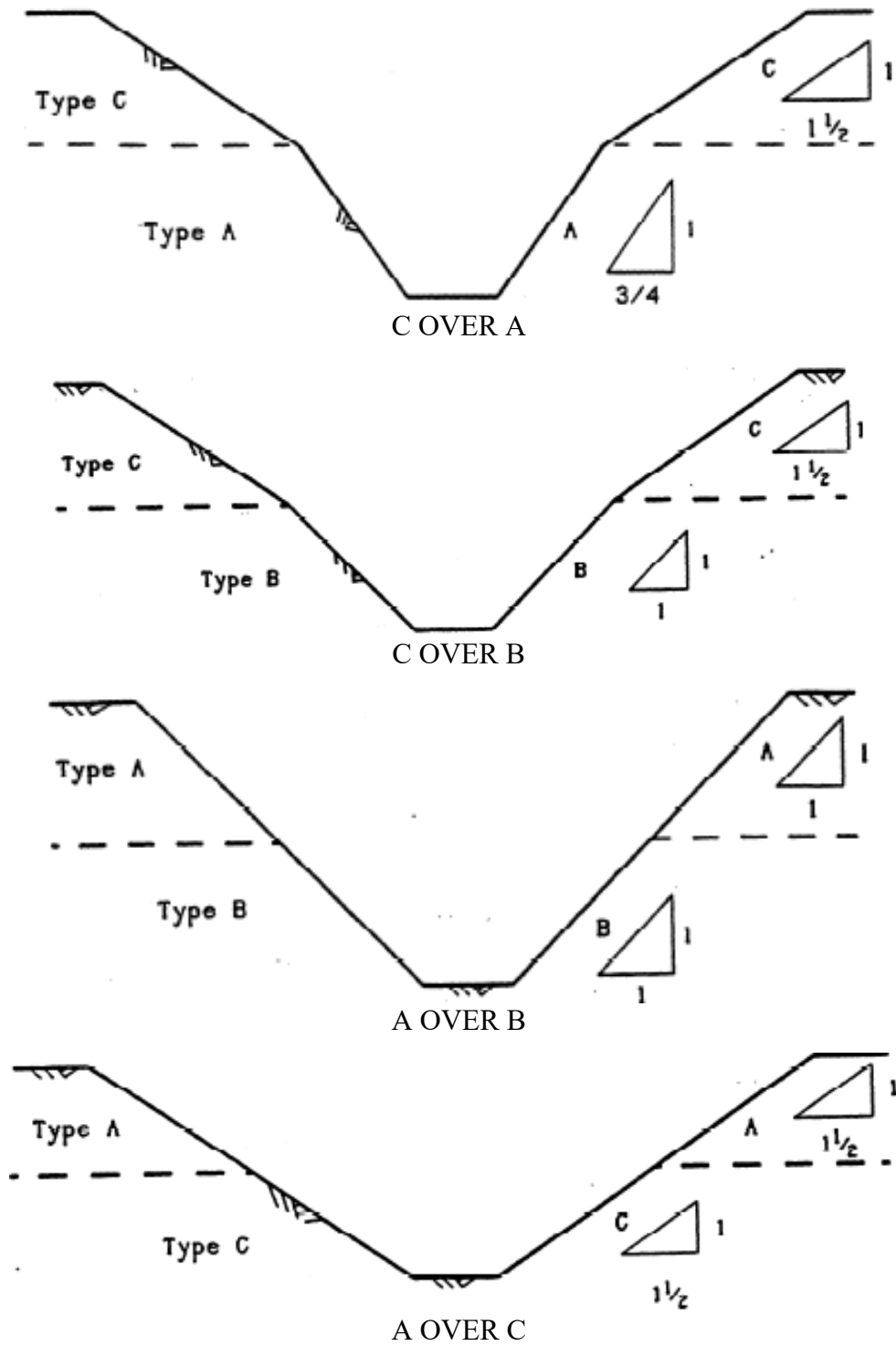

CT TRENCHING AND SHORING MANUAL

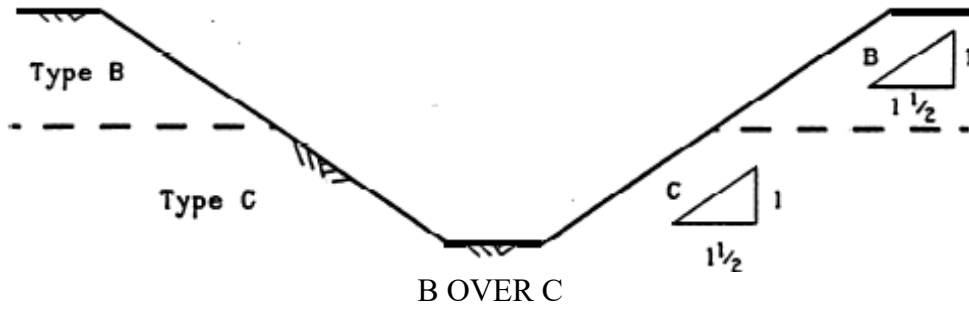

2. All other sloped excavations shall be in accordance with the other options permitted in 1541.1(b).

Appendix C to Section 1541.1

TIMBER SHORING FOR TRENCHES

(a) Scope

This appendix contains information that can be used when timber shoring is provided as a method of protection from cave-ins in trenches that do not exceed 20 feet in depth. This appendix must be used when design of timber shoring protective systems is to be performed in accordance with Section 1541.1(c)(1). Other timber shoring configurations; other systems of support such as hydraulic and pneumatic systems; and other protective systems such as sloping, benching, shielding, and freezing systems must be designed in accordance with the requirements set forth in Section 1541.1(b) and 1541.1(c).

(b) Soil Classification.

In order to use the data presented in this appendix, the soil type or types in which the excavation is made must first be determined using the soil classification method set forth in Article 6.

(c) Presentation of Information.

Information is presented in several forms as follows:

- (1) Information is presented in tabular form in Tables C-1.1, C-1.2, and C-1.3 and Tables C-2.1, C-2.2 and C-2.3 following Section (g) of Appendix C. Each table presents the minimum sizes of timber members to use in a shoring system, and each table contains data only for the particular soil type in which the excavation or portion of the excavation is made. The data are arranged to allow the user the flexibility to select from among several acceptable configurations of members based on varying the horizontal spacing of the crossbraces. Stable rock is exempt from shoring requirements and therefore, no data are presented for this condition.
- (2) Information concerning the basis of the tabular data and the limitations of the data is presented in Section (d) of this appendix, and on the tables themselves.
- (3) Information explaining the use of the tabular data is presented in Section (e) of this appendix.

CT TRENCHING AND SHORING MANUAL

- (4) Information illustrating the use of the tabular data is presented in Section (f) of this appendix.
- (5) Miscellaneous notations regarding Tables C-1.1 through C-1.3 and Tables C-2.1 through C-2.3 are presented in Section (g) of this appendix.

(d) Basis and limitations of the data.

- (1) Dimensions of timber members.
 - (A) The sizes of the timber members listed in Tables C-1.1 through C-1.3 are taken from the National Bureau of Standards (NBS) report, "Recommended Technical Provisions for Construction Practice in Shoring and Sloping of Trenches and Excavations." In addition, where NBS did not recommend specific sizes of members, member sizes are based on an analysis of the sizes required for use by existing codes and on empirical practice.
 - (B) The required dimensions of the members listed in Tables C-1.1 through C-1.3 refer to actual dimensions and not nominal dimensions of the timber. Employers wanting to use nominal size shoring are directed to Tables C-2.1 through C-2.3, or have this choice under Section 1541.1(c)(3).
- (2) Limitations of application.
 - (A) It is not intended that the timber shoring specification apply to every situation that may be experienced in the field. These data were developed to apply to the situations that are most commonly experienced in current trenching practice. Shoring systems for use in situations that are not covered by the data in this appendix must be designed as specified in Section 1541.1(c).
 - (B) When any of the following conditions are present, the members specified in the tables are not considered adequate. Either an alternate timber shoring system must be designed or another type of protective system designed in accordance with Section 1541.1.
 - 1. When loads imposed by structures or by stored material adjacent to the trench weigh in excess of the load imposed by a two-foot soil surcharge. The term "adjacent" as used here means the area within a

APPENDIX A

horizontal distance from the edge of the trench equal to the depth of the trench.

2. When vertical loads imposed on crossbraces exceed a 240-pound gravity load distributed on a one-foot section of the center of the crossbrace.
3. When surcharge loads are present from equipment weighing in excess of 20,000 pounds.
4. When only the lower portion of the trench is shored and the remaining portion of the trench is sloped or benched unless:

The sloped portion is sloped at an angle less steep than three horizontal to one vertical;

or the members are selected from the tables for use at a depth which is determined from the top of the overall trench, and not from the top of the sloped portion.

(e) Use of Tables.

The members of the shoring system that are to be selected using this information are the crossbraces, the uprights, and the wales, where wales are required. Minimum sizes of members are specified for use in different types of soil. There are six tables of information, two for each soil type. The soil type must first be determined in accordance with the soil classification system described in Appendix A. Using the appropriate table, the selection of the size and spacing of the members is then made. The selection is based on the depth and width of the trench where the members are to be installed and, in most instances, the selection is also based on the horizontal spacing of the crossbraces. Instances where a choice of horizontal spacing of crossbraces is available, the horizontal spacing of the crossbraces must be chosen by the user before the size of any member can be determined. When the soil type, the width and depth of the trench, and the horizontal spacing of the crossbraces are known, the size and vertical spacing of the crossbracing, the size and vertical spacing of the wales, and the size and horizontal spacing of the uprights can be read from the appropriate table.

(f) Examples to Illustrate the Use of Tables C-1.1 through C-1.3

- (1) Example 1.

CT TRENCHING AND SHORING MANUAL

A trench dug in Type A soil is 13 feet deep and five feet wide. From Table C-1.1 four acceptable arrangements of timber can be used.

Arrangement #1

Space 4x4 crossbraces at six feet horizontally and four feet vertically. Wales are not required. Space 3x8 uprights at six feet horizontally. This arrangement is commonly called "skip shoring."

Arrangement #2

Space 4x6 crossbraces at eight feet horizontally and four feet vertically.
Space 8x8 wales at four feet vertically. Space 2x6 uprights at four feet horizontally.

Arrangement #3

Space 6x6 crossbraces at 10 feet horizontally and four feet vertically.
Space 8x10 wales at four feet vertically.
Space 2x6 uprights at six feet horizontally.

Arrangement #4

Space 6x6 crossbraces at 12 feet horizontally and 4 feet vertically.
Space 10x10 wales at four feet vertically.
Space 3x8 uprights at six feet horizontally.

(2) Example 2.

A trench dig in Type B soil is 13 feet deep and five feet wide.

From Table C-1.2 three acceptable arrangements of members are listed.

Arrangement #1

Space 6x6 crossbraces at six feet horizontally and five feet vertically.
Space 8x8 wales at five feet vertically.
Space 2x6 uprights at two feet horizontally.

Arrangement #2

Space 6x8 crossbraces at eight feet horizontally and five feet vertically.
Space 10x10 wales at five feet vertically.
Space 2x6 uprights at two feet horizontally.

Arrangement #3

Space 8x8 crossbraces at 10 feet horizontally and five feet vertically.

APPENDIX A

Space 10x12 wales at five feet vertically.

Space 2x6 uprights at two feet vertically.

(3) Example 3.

A trench dug in Type C soil is 13 feet deep and five feet wide. From Table C-1.3 two acceptable arrangements of members can be used.

Arrangement #1

Space 8x8 crossbraces at six feet horizontally and five feet vertically.

Space 10x12 wales at five feet vertically.

Position 2x6 uprights as closely together as possible. If water must be retained use special tongue and groove uprights to form tight sheeting.

Arrangement #2

Space 8x30 crossbraces at eight feet horizontally and five feet vertically.

Space 12x12 wales at five feet vertically.

Position 2x6 uprights in a close sheeting configuration unless water pressure must be resisted. Tight sheeting must be used where water must be retained.

(4) Example 4.

A trench dug in Type C soil is 20 feet deep and 11 feet wide. The size and spacing of members for the section of trench that is over 15 feet in depth is determined using Table C-1.3. Only one arrangement of members is provided.

Space 8x10 crossbraces at six feet horizontally and five feet vertically.

Space 12x12 wales at five feet vertically.

Use 3x6 tight sheeting.

Use of Tables C-2.1 through C-2.3 would follow the same procedures.

(g) Notes for all Tables.

1. Member sizes at spacing other than indicated are to be determined as specified in Section 1541.1(c), "Design of Protective Systems."
2. When conditions are saturated or submerged use Tight Sheeting. Tight Sheeting refers to the use of specially-edged timber planks (e.g. tongue and groove) at least three inches thick, steel sheet piling, or similar construction that when driven or placed in position provide a tight wall to resist the lateral pressure of water and to

CT TRENCHING AND SHORING MANUAL

prevent the loss of backfill material. Close Sheeting refers to the placement of planks side-by-side allowing as little space as possible between them.

3. All spacing indicated is measured center to center.
4. Wales to be installed with greater dimension horizontal.
5. If the vertical distance from the center of the lowest crossbrace to the bottom of the trench exceeds two and one-half feet, uprights shall be firmly embedded or a mudsill shall be used. When the uprights are embedded, the vertical distance from the center of the lowest crossbrace to the bottom of the trench shall not exceed 36 inches. When mudsills are used, the vertical distance shall not exceed 42 inches. Mudsills are wales that are installed at the toe of the trench side.
6. Trench jacks may be used in lieu of or in combination with timber crossbraces.
7. Placement of crossbraces. When the vertical spacing of crossbraces is four feet, place the top crossbrace no more than two feet below the top of the trench. When the vertical spacing of crossbraces is five feet, place the top crossbrace no more than 2.5 feet below the top of the trench.

APPENDIX A

TABLE C-1.1 TIMBER TRENCH SHORING - - MINIMUM TIMBER REQUIREMENTS*
 SOIL TYPE A: $P_a = 25 \times H + 72$ psf (2 Ft. Surcharge)

DEPTH OF TRENCH (FEET)	SIZE (ACTUAL) AND SPACING OF MEMBERS **													
	HORIZ. SPACING (FEET)	CROSS BRACES					VERT. SPACING (FEET)	WALES		UPRIGHTS				
		WIDTH OF TRENCH (FEET)						SIZE (IN)	VERT. SPACING (FEET)	MAXIMUM ALLOWABLE HORIZONTAL SPACING (FEET)				
		UP TO 4	UP TO 6	UP TO 9	UP TO 12	UP TO 15				CLOSE	4	5	6	8
5 TO 10	UP TO 6	4X4	4X4	4X6	6X6	6X6	4	Not Req'd	---				2X6	
	UP TO 8	4X4	4X4	4X6	6X6	6X6	4	Not Req'd	---					2X8
	UP TO 10	4X6	4X6	4X6	6X6	6X6	4	8X8	4			2X6		
	UP TO 12	4X6	4X6	6X6	6X6	6X6	4	8X8	4				2X6	
5 TO 10	UP TO 6	4X4	4X4	4X6	6X6	6X6	4	Not Req'd	---				3X8	
	UP TO 8	4X6	4X6	6X6	6X6	6X6	4	8X8	4		2X6			
	UP TO 10	6X6	6X6	6X6	6X8	6X8	4	8X10	4			2X6		
	UP TO 12	6X6	6X6	6X6	6X8	6X8	4	10X10	4				3X8	
5 TO 10	UP TO 6	6X6	6X6	6X6	6X8	6X8	4	6X8	4	3X6				
	UP TO 8	6X6	6X6	6X6	6X8	6X8	4	8X8	4	3X6				
	UP TO 10	8X8	8X8	8X8	8X8	8X10	4	8X10	4	3X6				
	UP TO 12	8X8	8X8	8X8	8X8	8X10	4	10X10	4	3X6				
OVER 20	SEE NOTE 1													

* Mixed oak or equivalent with a bending strength not less than 850 psi.

** Manufactured members of equivalent strength may be substituted for wood.

CT TRENCHING AND SHORING MANUAL

TABLE C-1.2 TIMBER TRENCH SHORING - - MINIMUM TIMBER REQUIREMENTS*
 SOIL TYPE B: $P_a = 45 \times H + 72$ psf (2 Ft. Surcharge)

DEPTH OF TRENCH (FEET)	SIZE (ACTUAL) AND SPACING OF MEMBERS **													
	HORIZ. SPACING (FEET)	CROSS BRACES					VERT. SPACING (FEET)	WALES		UPRIGHTS				
		WIDTH OF TRENCH (FEET)						SIZE (IN)	VERT. SPACING (FEET)	MAXIMUM ALLOWABLE HORIZONTAL SPACING (FEET)				
	UP TO 4	UP TO 6	UP TO 9	UP TO 12	UP TO 15						CLOSE	2	3	
5 TO 10	UP TO 6	4X6	4X6	6X6	6X6	6X6	5	6X8	5			2X6		
	UP TO 8	6X6	6X6	6X6	6X8	6X8	5	8X10	5			2X6		
	UP TO 10	6X6	6X6	6X6	6X8	6X8	5	10X10	5			2X6		
	See Note 1													
5 TO 10	UP TO 6	6X6	6X6	6X6	6X8	6X8	5	8X8	5		2X6			
	UP TO 8	6X8	6X8	6X8	8X8	8X8	5	10X10	5		2X6			
	UP TO 10	8X8	8X8	8X8	8X8	8X10	5	10X12	5		2X6			
	See Note 1													
5 TO 10	UP TO 6	6X8	6X8	6X8	8X8	8X8	5	8X10	5	3X6				
	UP TO 8	8X8	8X8	8X8	8X8	8X10	5	10X12	5	3X6				
	UP TO 10	8X10	8X10	8X10	8X10	10X10	5	12X12	5	3X6				
	See Note 1													
OVER 20	SEE NOTE 1													

* Mixed oak or equivalent with a bending strength not less than 850 psi.

** Manufactured members of equivalent strength may be substituted for wood.

APPENDIX A

TABLE C-1.3 TIMBER TRENCH SHORING - - MINIMUM TIMBER REQUIREMENTS*
 SOIL TYPE C: $P_a = 80 \times H + 72$ psf (2 Ft. Surcharge)

DEPTH OF TRENCH (FEET)	SIZE (ACTUAL) AND SPACING OF MEMBERS **														
	HORIZ. SPACING (FEET)	CROSS BRACES					VERT. SPACING (FEET)	WALES		UPRIGHTS					
		WIDTH OF TRENCH (FEET)						SIZE (IN)	VERT. SPACING (FEET)	MAXIMUM ALLOWABLE HORIZONTAL SPACING (FEET)					
	UP TO 4	UP TO 6	UP TO 9	UP TO 12	UP TO 15						CLOSE				
5 TO 10	UP TO 6	6X8	6X8	6X8	8X8	8X8	5	8X10	5	2X6					
	UP TO 8	8X8	8X8	8X8	8X8	8X10	5	10X12	5	2X6					
	UP TO 10	8X10	8X10	8X10	8X10	10X10	5	12X12	5	2X6					
	See Note 1														
5 TO 10	UP TO 6	8X8	8X8	8X8	8X8	8X10	5	10X12	5	2X6					
	UP TO 8	8X10	8X10	8X10	8X10	10X10	5	12X12	5	2X6					
	See Note 1														
	See Note 1														
5 TO 10	UP TO 6	8X10	8X10	8X10	8X10	10X10	5	12X12	5	3X6					
	See Note 1														
	See Note 1														
	See Note 1														
OVER 20	SEE NOTE 1														

* Mixed oak or equivalent with a bending strength not less than 850 psi.

** Manufactured members of equivalent strength may be substituted for wood.

CT TRENCHING AND SHORING MANUAL

TABLE C-2.1 TIMBER TRENCH SHORING - - MINIMUM TIMBER REQUIREMENTS*
SOIL TYPE A: $P_a = 25 \times H + 72$ psf (2 Ft. Surcharge)

DEPTH OF TRENCH (FEET)		SIZE (ACTUAL) AND SPACING OF MEMBERS **												
		CROSS BRACES					WALES		UPRIGHTS					
		HORIZ. SPACING (FEET)	WIDTH OF TRENCH (FEET)					VERT. SPACING (FEET)	SIZE (IN)	VERT. SPACING (FEET)	MAXIMUM ALLOWABLE HORIZONTAL SPACING (FEET)			
UP TO 4	UP TO 6		UP TO 9	UP TO 12	UP TO 15	CLOSE	4				5	6	8	
5 TO 10	UP TO 6	4X4	4X4	4X4	4X4	4X6	4	Not Req'd	Not Req'd				4X6	
	UP TO 8	4X4	4X4	4X4	4X6	4X6	4	Not Req'd	Not Req'd					4X8
	UP TO 10	4X6	4X6	4X6	6X6	6X6	4	8X8	4			4X6		
	UP TO 12	4X6	4X6	4X6	6X6	6X6	4	8X8	4				4X6	
5 TO 10	UP TO 6	4X4	4X4	4X4	6X6	6X6	4	Not Req'd	Not Req'd				4X10	
	UP TO 8	4X6	4X6	4X6	6X6	6X6	4	6X8	4		4X6			
	UP TO 10	6X6	6X6	6X6	6X6	6X6	4	8X10	4			4X8		
	UP TO 12	6X6	6X6	6X6	6X6	6X6	4	6X10	4		4X6		4X10	
5 TO 10	UP TO 6	6X6	6X6	6X6	6X6	6X6	4	6X8	4	3X6				
	UP TO 8	6X6	6X6	6X6	6X6	6X6	4	8X8	4	3X6	4X12			
	UP TO 10	6X6	6X6	6X6	6X6	6X8	4	8X10	4	3X6				
	UP TO 12	6X6	6X6	6X6	6X8	6X8	4	8X12	4	3X6	4X12			
OVER 20	SEE NOTE 1													

* Douglas fir or equivalent with a bending strength not less than 1500 psi.

** Manufactured members of equivalent strength may be substituted for wood.

APPENDIX A

TABLE C-2.2 TIMBER TRENCH SHORING - - MINIMUM TIMBER REQUIREMENTS*
 SOIL TYPE B: $P_a = 45 \times H + 72$ psf (2 Ft. Surcharge)

DEPTH OF TRENCH (FEET)		SIZE (ACTUAL) AND SPACING OF MEMBERS **												
		CROSS BRACES					WALES				UPRIGHTS			
		HORIZ. SPACING (FEET)	WIDTH OF TRENCH (FEET)					VERT. SPACING (FEET)	SIZE (IN)	VERT. SPACING (FEET)	MAXIMUM ALLOWABLE HORIZONTAL SPACING (FEET)			
UP TO 4	UP TO 6		UP TO 9	UP TO 12	UP TO 15	CLOSE	2				3	4	6	
5 TO 10	UP TO 6	4X6	4X6	6X6	6X6	6X6	5	6X8	5			3X12 4X8		4X12
	UP TO 8	4X6	4X6	6X6	6X6	6X6	5	8X8	5		3X8		4X8	
	UP TO 10	4X6	4X6	6X6	6X6	6X6	5	8X10	5			4X8		
	See Note 1													
5 TO 10	UP TO 6	6X6	6X6	6X6	6X8	6X8	5	8X8	5	3X6	4X10			
	UP TO 8	6X8	6X8	6X8	8X8	8X8	5	10X10	5	3X6	4X10			
	UP TO 10	6X8	6X8	8X8	8X8	8X8	5	10X12	5	3X6	4X10			
	See Note 1													
5 TO 10	UP TO 6	6X8	6X8	6X8	6X8	8X8	5	8X10	5	4X6				
	UP TO 8	6X8	6X8	6X8	8X8	8X8	5	10X12	5	4X6				
	UP TO 10	8X8	8X8	8X8	8X8	8X8	5	12X12	5	4X6				
	See Note 1													
OVER 20	SEE NOTE 1													

* Douglas fir or equivalent with a bending strength not less than 1500 psi.

** Manufactured members of equivalent strength may be substituted for wood.

CT TRENCHING AND SHORING MANUAL

TABLE C-2.3 TIMBER TRENCH SHORING - - MINIMUM TIMBER REQUIREMENTS*
SOIL TYPE C: $P_a = 80 \times H + 72$ psf (2 Ft. Surcharge)

DEPTH OF TRENCH (FEET)	SIZE (ACTUAL) AND SPACING OF MEMBERS **														
	HORIZ. SPACING (FEET)	CROSS BRACES					VERT. SPACING (FEET)	WALES		UPRIGHTS					
		WIDTH OF TRENCH (FEET)						SIZE (IN)	VERT. SPACING (FEET)	MAXIMUM ALLOWABLE HORIZONTAL SPACING (FEET)					
	UP TO 4	UP TO 6	UP TO 9	UP TO 12	UP TO 15						CLOSE				
5 TO 10	UP TO 6	6X6	6X6	6X6	8X6	8X8	5	8X8	5	3X6					
	UP TO 8	6X6	6X6	6X6	8X8	8X8	5	10X10	5	3X6					
	UP TO 10	6X6	6X6	8X8	8X8	8X8	5	12X12	5	3X6					
	See Note 1														
5 TO 10	UP TO 6	6X8	6X8	6X8	8X8	8X8	5	10X10	5	4X6					
	UP TO 8	8X8	8X8	8X8	8X8	8X8	5	12X12	5	4X6					
	See Note 1														
	See Note 1														
5 TO 10	UP TO 6	8X8	8X8	8X8	8X10	8X10	5	10X12	5	4X6					
	See Note 1														
	See Note 1														
	See Note 1														
OVER 20	SEE NOTE 1														

* Douglas fir or equivalent with a bending strength not less than 1500 psi.

** Manufactured members of equivalent strength may be substituted for wood.

Appendix D to Section 1541.1

ALUMINUM HYDRAULIC SHORING FOR TRENCHES

(a) Scope.

This appendix contains information that can be used when aluminum hydraulic shoring is provided as a method of protection against cave-ins in trenches that do not exceed 20 feet in depth. This appendix must be used when design of the aluminum hydraulic protective system cannot be performed in accordance with Section 1541.1(c)(2).

(b) Soil Classification.

In order to use data presented in this appendix, the soil type or types in which the excavation is made must first be determined using the soil classification method set forth in Appendix A of this Article.

(c) Presentation of Information.

Information is presented in several forms as follows:

- (1) Information is presented in tabular form in Tables D-1.1, D-1.2, D-1.3 and D-1.4. Each table presents the maximum vertical and horizontal spacings that may be used with various aluminum member sizes and various hydraulic cylinder sizes. Each table contains data only for the particular soil type in which the excavation or portion of the excavation is made. Tables D-1.1 and D-1.2 are for the vertical shores in Types A and B soil. Tables D-1.3 and D-1.4 are for horizontal waler systems in Type B and C soil.
- (2) Information concerning the basis of the tabular data and the limitations of the data is presented in Section (d) of this appendix.
- (3) Information explaining the use of the tabular data is presented in Section (e) of this appendix.
- (4) Information illustrating the use of the tabular data is presented in Section (f) of the appendix.
- (5) Miscellaneous notations (footnotes) regarding Table D-1.1 through D-1.4 are presented in Section (g) of this appendix.
- (6) Figures, illustrating typical installations of hydraulic shoring, are included just prior to the Tables. The illustrations page is entitled "Aluminum Hydraulic Shoring: Typical Installations."

(d) Basis and Limitations of the data.

- (1) Vertical shore rails and horizontal wales are those that meet the Section Modulus requirements in the D-1 Tables. Aluminum material is 6061-T6 or material of equivalent strength and properties.
- (2) Hydraulic cylinders specifications.
 - (A) 2 inch cylinders shall be a minimum 2-inch inside diameter with a minimum safe working capacity of no less than 18,000 pounds axial compressive load at maximum extension. Maximum extension is to include full range of cylinder extensions as recommended by product manufacturer.
 - (B) 3-inch cylinders shall be a minimum 3-inch inside diameter with a safe working capacity of not less than 30,000 pounds axial compressive load at extensions as recommended by product manufacturer.
- (3) Limitation of application.
 - (A) It is not intended that the aluminum hydraulic specification apply to every situation that may be experienced in the field. These data were developed to apply to the situations that are most commonly experienced in current trenching practice. Shoring systems for use in situations that are not covered by the data in this appendix must be otherwise designed as specified in Section 1541.1(c).
 - (B) When any of the following conditions are present, the members specified in the Tables are not considered adequate. In this case, an alternative aluminum hydraulic shoring system or other type of protective system must be designed in accordance with Section 1541.1.
 1. When vertical loads imposed in crossbraces exceed a 100 pound gravity load distributed on a one foot section of the center of the hydraulic cylinder.
 2. When surcharge loads are present from equipment weighing in excess of 20,000 pounds.
 3. When only the lower portion of the trench is shored and the remaining portion of the trench is sloped or benched unless: The sloped portion is sloped at an angle less steep than three horizontal to one vertical; or

APPENDIX A

the members are selected from tables for use at a depth which is determined from the top of the overall trench, and not from the toe of the sloped portion.

(e) Use of Tables D-1.1, D-1.2, D-1.3 and D-1.4.

The members of the shoring system that are to be selected using this information are the hydraulic cylinders, and either the vertical shores or the horizontal wales. When a waler system is used the vertical timber sheeting to be used is also selected from these tables. The Tables D-1.1 and D-1.2 for vertical shores are used in Type A and B soils that do not require sheeting. Type B soils that may require sheeting, and Type C soils that always require sheeting, are found in the horizontal wale Tables D-1.3 and D-1.4. The soil type must first be determined in accordance with the soil classification system described in Appendix A to Section 1541.1. Using the appropriate table, the selection of the size and spacing of the members is made. The selection is based on the depth and width of the trench where the members are to be installed. In these tables the vertical spacing is held constant at four feet on center. The tables show the maximum horizontal spacing of cylinders allowed for each size of wale in the waler system tables, and in the vertical shore tables, the hydraulic cylinder horizontal spacing is the same as the vertical shore spacing.

(f) Example to Illustrate the Use of the Tables:

(1) Example 1:

A trench dug in Type A soil is 6 feet deep and 3 feet wide.

From Table D-1.1: Find vertical shores and 2 inch diameter cylinders spaced 8 feet on center (o.c.) horizontally and 4 feet on center (o.c.) vertically. (See Figures 1 & 3 for typical installations.)

(2) Example 2:

A trench is dug in Type B soil that does not require sheeting, 13 feet deep and 5 feet wide.

From Table D-1.2: Find vertical shores and 2 inch diameter cylinders spaced 6.5 feet o.c. horizontally and 4 feet o.c. vertically. (See Figures 1 & 3 for typical installations.)

(3) Example 3:

CT TRENCHING AND SHORING MANUAL

A trench is dug in Type B soil that does not require sheeting, but does experience some minor raveling of the trench face. The trench is 16 feet deep and 9 feet wide.

From Table D-1.2: Find vertical shores and 2 inch diameter cylinder (with special oversleeves as designated by footnote #2) spaced 5.5 feet o.c. horizontally and 4 feet o.c. vertically. Plywood (per footnote (g)(7) to the D-1 Table) should be used behind the shores. (See Figures 2 & 3 for typical installations.)

(4) Example 4:

A trench is dug in previously disturbed Type B soil, with characteristics of a Type C soil, and will require sheeting. The trench is 18 feet deep and 12 feet wide. 8 Foot horizontal spacing between cylinders is desired for working space.

From Table D-1.3: Find horizontal wale with a section modulus of 14.0 spaced at 4 feet o.c. vertically and 3 inch diameter cylinder spaced at 9 feet maximum o.c. horizontally, 3x12 timber sheeting is required at close spacing vertically. (See Figure 4 for typical installation.)

(5) Example 5:

A trench is dug in Type C soil, 9 feet deep and 4 feet wide. Horizontal cylinder spacing in excess of 6 feet is desired for working space.

From Table D-1.4: Find horizontal wale with a section modulus of 7.0 and 2 inch diameter cylinders spaced at 6.5 feet o.c. horizontally. Or, find horizontal wale with a 14.0 section modulus and 3 inch diameter cylinder spaced at 10 feet o.c. horizontally. Both wales are spaced 4 feet o.c. vertically. 3x12 timber sheeting is required at close spacing vertically. (See Figure 4 for typical installation.)

(g) Footnotes, and general notes for Tables D-1.1, D-1.2, D-1.3, and D-1.4.

- (1) For applications other than those listed in the tables, refer to Section 1541.1(c)(2) for use of manufacturer's tabulated data. For trench depths in excess of 20 feet, refer to Section 1541.1(c)(2) and 1541.1(c)(3).

APPENDIX A

- (2) 2-inch diameter cylinders, at this width, shall have structural steel tube (3.5 x 3.5 x 0.1875) oversleeves, or structural oversleeves of manufacturer's specification, extending the full, collapsed length.
- (3) Hydraulic cylinder capacities.
 - (A) 2-Inch cylinders shall be a minimum 20 inch inside diameter with a safe working capacity of not less than 18,000 pounds axial compressive load at maximum extension. Maximum extension is to include full range of cylinder extension as recommended by product manufacturer.
 - (B) 3-Inch cylinders shall be a minimum 3-inch inside diameter with a safe working capacity of not less than 30,000 pounds axial compressive load at maximum extension. Maximum extension is to include full range of cylinder extensions as recommended by product manufacturer.
- (4) All spacing indicated is measured center to center. Vertical shoring rails shall have a minimum section modulus of 0.40 inch.
- (5) When vertical shores are used, there must be a minimum of three shores spaced equally, horizontally, in a group.
- (7) Plywood shall be 1.125 inches thick of wood or 0.75 inch thick, 14 ply, arctic white birch (Finland form). Please note that plywood is not intended as a structural member, but only for prevention of local raveling (sloughing of the trench face) between shores. Equivalent material may be used if it has been approved in accordance with Section 1505(a).
- (8) See Appendix C for timber specifications.
- (9) Wales are calculated for simple span conditions.
- (10) See Appendix D, Section (d), for basis and limitations of the data.

CT TRENCHING AND SHORING MANUAL

TABLE D-1.1 ALUMINUM HYDRAULIC SHORING
SOIL TYPE A VERTICAL SHORES

DEPTH OF TRENCH (FEET)	HYDRAULIC CYLINDERS				
	MAXIMUM HORIZONTAL SPACING (FEET)	MAXIMUM VERTICAL SPACING (FEET)	WIDTH OF TRENCH (FEET)		
			UP TO 8	OVER 8 UP TO 12	OVER 12 UP TO 15
OVER 5 UP TO 10	8	4	2 INCH DIAMETER	2 INCH DIAMETER NOTE (2)	3 INCH DIAMETER
OVER 10 UP TO 15	8				
OVER 15 UP TO 20	7				
OVER 20	NOTE (1)				

Footnotes to tables and general notes on hydraulic shoring are found in Appendix D. Item (g).

Note (1): See Appendix D. Item (g)(1)

Note (2): See Appendix D. Item (g)(2)

APPENDIX A

TABLE D-1.2 ALUMINUM HYDRAULIC SHORING
SOIL TYPE B VERTICAL SHORES

DEPTH OF TRENCH (FEET)	HYDRAULIC CYLINDERS				
	MAXIMUM HORIZONTAL SPACING (FEET)	MAXIMUM VERTICAL SPACING (FEET)	WIDTH OF TRENCH (FEET)		
			UP TO 8	OVER 8 UP TO 12	OVER 12 UP TO 15
OVER 5 UP TO 10	8	4	2 INCH DIAMETER	2 INCH DIAMETER NOTE (2)	3 INCH DIAMETER
OVER 10 UP TO 15	6.5				
OVER 15 UP TO 20	5.5				
OVER 20	NOTE (1)				

Footnotes to tables and general notes on hydraulic shoring are found in Appendix D. Item (g).

Note (1): See Appendix D. Item (g)(1)

Note (2): See Appendix D. Item (g)(2)

CT TRENCHING AND SHORING MANUAL

TABLE D-1.3 ALUMINUM HYDRAULIC SHORING
WALER SYSTEM - - FOR SOIL TYPE B

DEPTH OF TRENCH (FEET)	WALES		HYDRAULIC CYLINDERS						TIMBER UPRIGHTS		
	VERTICAL SPACING (FEET)	* SECTION MODULUS (IN ³)	WIDTH OF TRENCH (FEET)						MAX. HORIZ. SPACING (ON CENTER)		
			UP TO 8		OVER 8 UP TO 12		OVER 12 UP TO 15		SOLID SHEET	2 FT.	3 FT.
			HORIZ SPACING	CYLINDER DIAMETER	HORIZ SPACING	CYLINDER DIAMETER	HORIZ SPACING	CYLINDER DIAMETER			
OVER 5 UP TO 10	4	3.5	8.0	2 IN	8.0	2 IN NOTE (2)	8.0	3 IN	---	---	3 X 12
		7.0	9.0	2 IN	9.0	2 IN NOTE (2)	9.0	3 IN			
		14.0	12.0	3 IN	12.0	3 IN	12.0	3 IN			
OVER 10 UP TO 15	4	3.5	6.0	2 IN	6.0	2 IN NOTE (2)	6.0	3 IN	---	3 X 12	---
		7.0	8.0	3 IN	8.0	3 IN	8.0	3 IN			
		14.0	10.0	3 IN	10.0	3 IN	10.0	3 IN			
OVER 15 UP TO 20	4	3.5	5.0	2 IN	5.5	2 IN NOTE (2)	5.5	3 IN	3 X 12	---	---
		7.0	6.0	3 IN	6.0	3 IN	6.0	3 IN			
		14.0	9.0	3 IN	9.0	3 IN	9.0	3 IN			
OVER 20	NOTE (1)										

Footnotes to tables and general notes on hydraulic shoring are found in Appendix D. Item (g).

Notes (1): See Appendix D. Item (g)(1)

Notes (2): See Appendix D. Item (g)(2)

*Consult product manufacturer and/or qualified engineer for section modulus of available wales.

APPENDIX A

TABLE D-1.4

ALUMINUM HYDRAULIC SHORING
WALER SYSTEM - - FOR SOIL TYPE C

DEPTH OF TRENCH (FEET)	WALES		HYDRAULIC CYLINDERS						TIMBER UPRIGHTS		
	VERTICAL SPACING (FEET)	* SECTION MODULUS (IN ³)	WIDTH OF TRENCH (FEET)						MAX. HORIZ. SPACING (ON CENTER)		
			UP TO 8		OVER 8 UP TO 12		OVER 12 UP TO 15		SOLID SHEET	2 FT.	3 FT.
			HORIZ SPACING	CYLINDER DIAMETER	HORIZ SPACING	CYLINDER DIAMETER	HORIZ SPACING	CYLINDER DIAMETER			
OVER 5 UP TO 10	4	3.5	6.0	2 IN	6.0	2 IN NOTE (2)	6.0	3 IN	3 X 12	—	—
		7.0	6.5	2 IN	6.5	2 IN NOTE (2)	6.5	3 IN			
		14.0	10.0	3 IN	10.0	3 IN	10.0	3 IN			
OVER 10 UP TO 15	4	3.5	4.0	2 IN	4.0	2 IN NOTE (2)	4.0	3 IN	3 X 12	—	—
		7.0	5.5	3 IN	5.5	3 IN	5.5	3 IN			
		14.0	8.0	3 IN	8.0	3 IN	8.0	3 IN			
OVER 15 UP TO 20	4	3.5	3.5	2 IN	3.5	2 IN NOTE (2)	3.5	3 IN	3 X 12	—	—
		7.0	5.0	3 IN	5.0	3 IN	5.0	3 IN			
		14.0	6.0	3 IN	6.0	3 IN	6.0	3 IN			
OVER 20	NOTE (1)										

Footnotes to tables and general notes on hydraulic shoring are found in Appendix D. Item (g).

Notes (1): See Appendix D. Item (g)(1)

Notes (2): See Appendix D. Item (g)(2)

*Consult product manufacturer and/or qualified engineer for section modulus of available wales.

Appendix E to Section 1541.1

ALTERNATIVES TO TIMBER SHORING

FIGURE 1

ALUMINUM HYDRAULIC SHORING

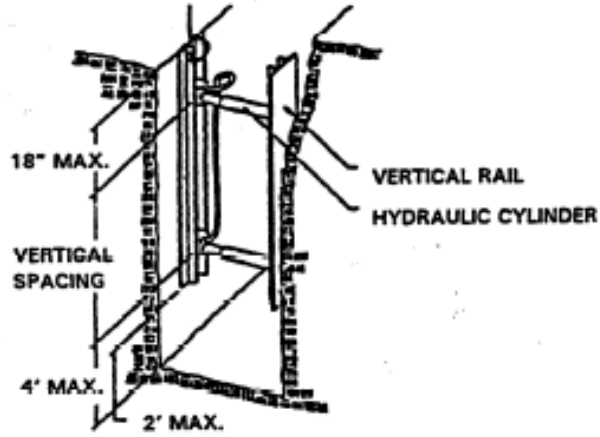

FIGURE 2

PNEUMATIC / HYDRALIC SHORING

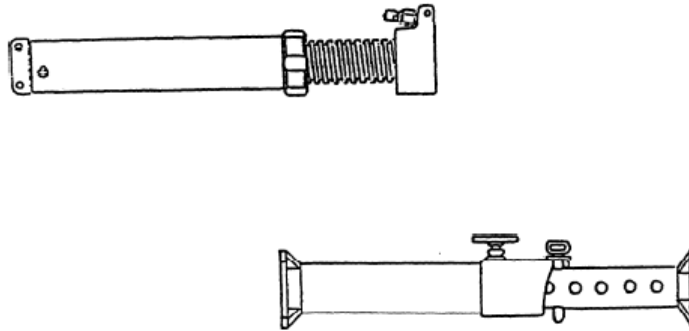

FIGURE 3

TRENCH JACKS (SCREW JACKS)

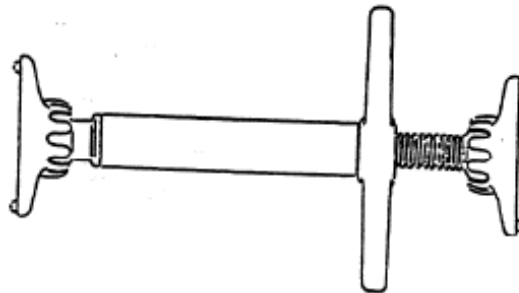
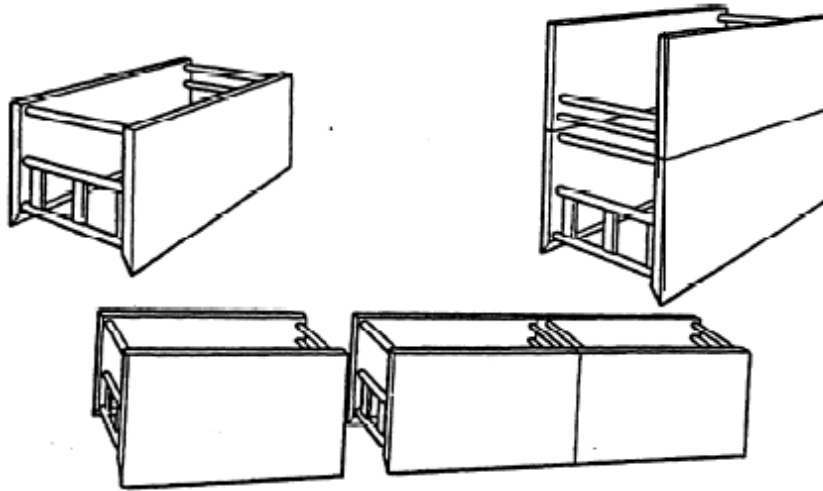

FIGURE 4

TRENCH SHIELDS



Appendix F to Section 1541.1

SELECTION OF PROTECTIVE SYSTEMS

The following figures are a graphic summary of the requirements contained in Article 6 for excavations 20 feet or less in depth. Protective systems for use in excavations more than 20 feet in depth must be designed by a registered professional engineer in accordance Section 1541.1 (b) and (c).

CT TRENCHING AND SHORING MANUAL

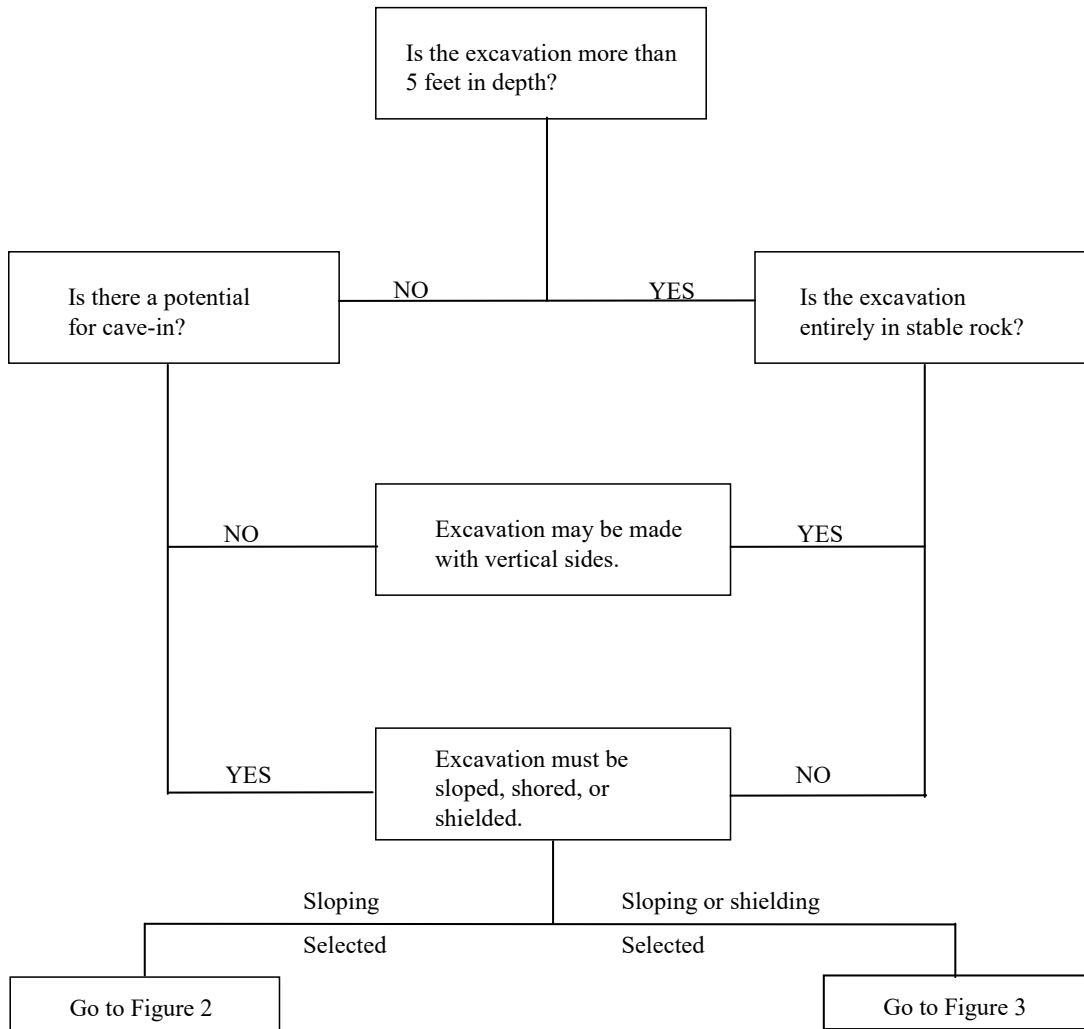

FIGURE 1 - PRELIMINARY DECISIONS

APPENDIX A

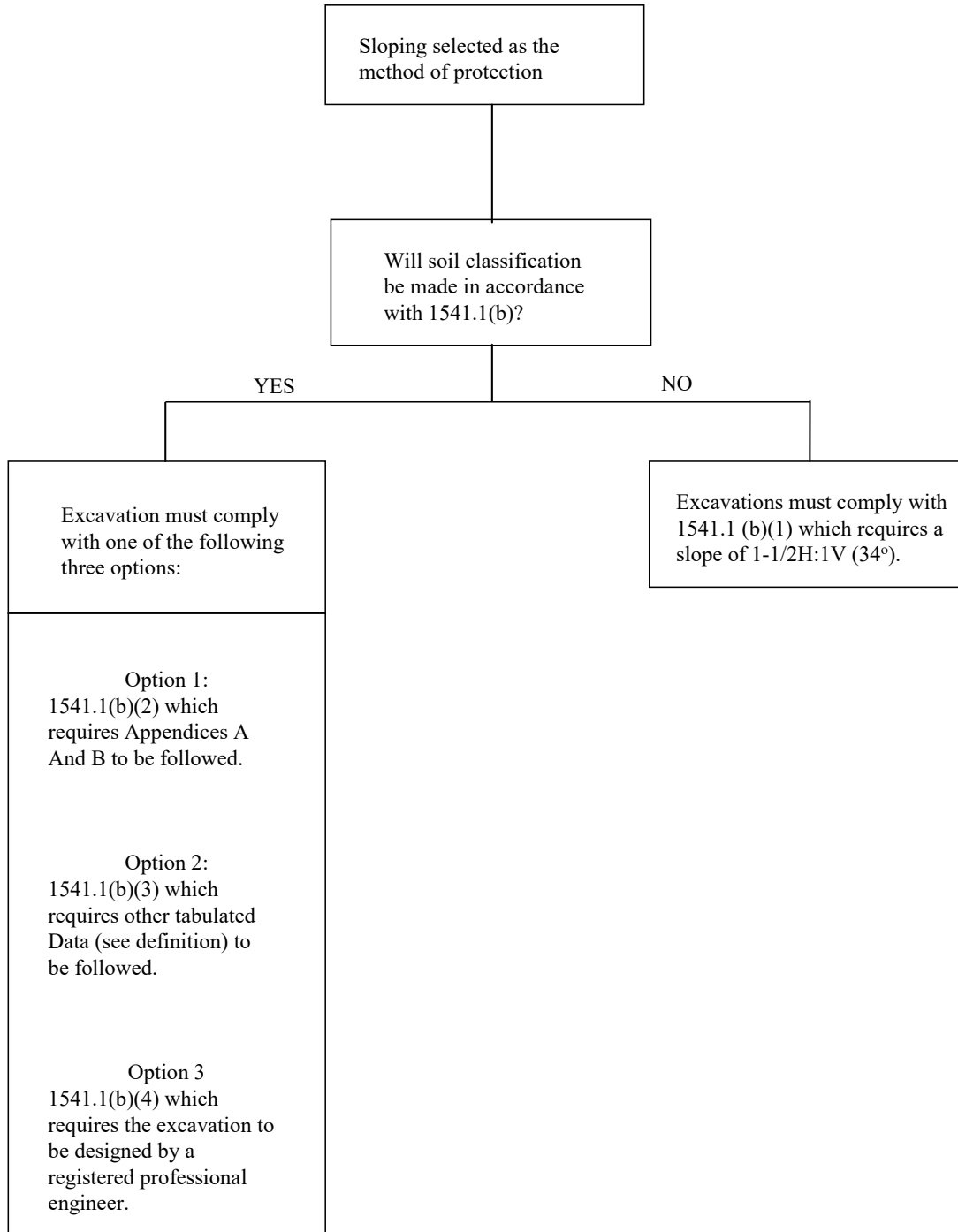

FIGURE 2 - SLOPING OPTIONS

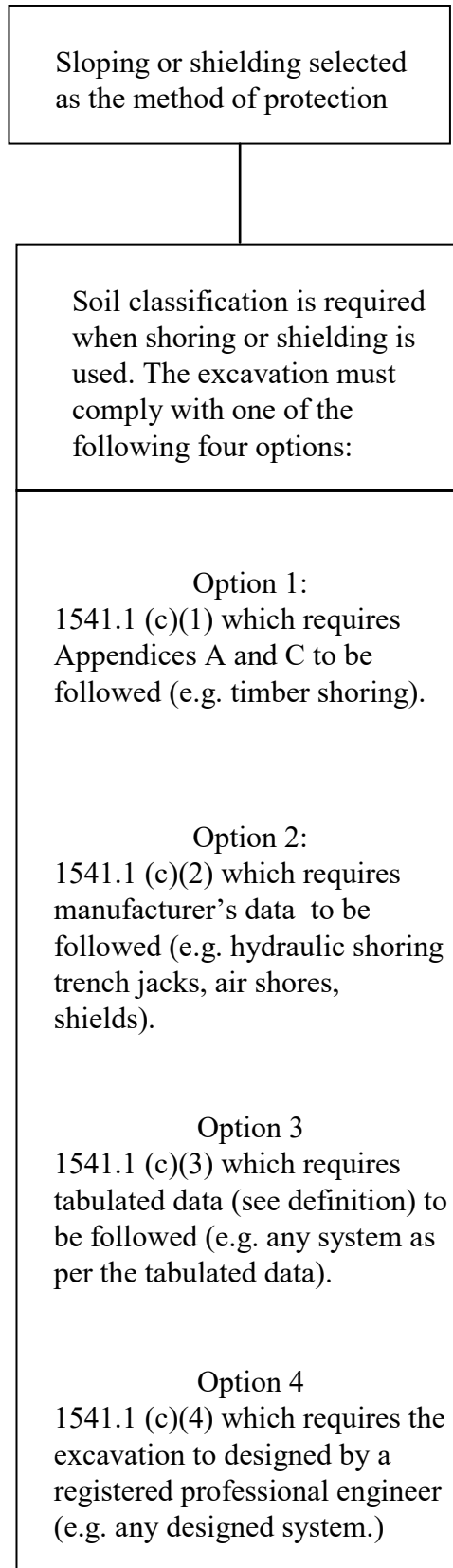

FIGURE 3 - SHORING AND SHIELDING OPTIONS

1542. SHAFTS

(a) General.

- (1) All wells or shafts over 5 feet in depth into which employees are permitted to enter shall be retained with lagging, spiling, or casing.

EXCEPTION: Exploration shafts; see Section 1542(d).

- (2) The lagging, spiling or casing shall extend at least one foot above ground level and shall be provided the full depth of the shaft or at least five feet into solid rock if possible.
- (3) All wells, pits, shafts, caissons, etc., shall be barricaded or securely covered.
- (4) Upon completion of exploration and similar operations, temporary wells, pits, shafts, etc., shall be backfilled.

(b) Small Shafts in Hard Compact Soil.

Two inch (nominal) cribbing may be used in square shafts not over 4 feet square in hard compact soil. Each member shall be cut 1/2 -way through the width of the member and dovetailed into position so each member will act as a shore as well as lagging. Strips shall be nailed in each corner to prevent the boards from dropping down.

(c) Shafts in Other Than Hard Compact Soil.

- (1) A system of lagging supported by braces and corner posts shall be used for square or rectangular shafts. Corner posts of 4-inch by 4-inch material are normally acceptable in shafts 4 feet square, or smaller, if they are braced in each direction with horizontal 4-inch by 4-inch members at intervals not exceeding 4 feet. Braces and corner posts in larger shafts shall be correspondingly larger as determined by a civil engineer.
- (2) Round shafts shall be completely lagged with 2-inch material which is supported at intervals not greater than 4 feet by means of adjustable rings of metal or timber that are designed to resist the collapsing force, or cased in a manner that provides equivalent protection.

(d) Exploration shafts.

Only a geotechnical specialist shall be permitted to enter an exploration shaft without lagging, spiling or casing for the purpose of subsurface investigations under the following conditions.

CT TRENCHING AND SHORING MANUAL

- (1) Initial Inspection. The type of materials and stability characteristics of the exploration shaft shall be personally observed and recorded by the geotechnical specialist during the drilling operation. Potentially unsafe exploration shafts shall not be entered.
- (2) Surface Casing. The upper portion of the exploration shaft shall be equipped with a surface ring-collar to provide casing support of the material within the upper 4 feet of the exploration shaft. The ring-collar shall extend at least 1- foot above the ground surface.
- (3) Gas Tests. Prior to entry into exploration shafts, tests and/or procedure shall be instituted to assure that the atmosphere within the shaft does not contain dangerous air contamination or oxygen deficiency. These tests and/or l procedures shall be maintained while working within the shaft to assure that dangerous air contamination or oxygen deficiency will not occur. See Section 5156 of the General Industry Safety Orders.)
- (4) Unstable Local Conditions. The geotechnical specialist shall not descend below any portion of any exploration shaft where caving or groundwater seepage is noted or suspected.
- (5) Ladder and Cable Descents. A ladder may be used to inspect exploration shafts 20 feet or less in depth. In deeper exploration shafts, properly maintained mechanical hoisting devices with a safety factor of at least 6 shall be provided and used. Such devices shall be under positive control of the operator being positive powered up and down with fail-safe breaks.
- (6) Emergency Standby Employee. An emergency standby employee shall be positioned at the surface near the exploration shaft whenever a geotechnical specialist is inside the shaft.
- (7) Communication. A two-way, electronically-operated communication system shall be in operation between the standby employee and the geotechnical specialist whenever boring inspections ate being made in exploration shafts over 20 feet in depth or when ambient noise levels make communication difficult.
- (8) Safety Equipment. The following safety equipment shall be used to protect the geotechnical specialist:

APPENDIX A

- (A) An approved safety harness which will suspend a person upright and that is securely attached to the hoist cable.
- (B) A 12-inch to 18-inch diameter steel cone shaped headguard/deflector that is attached to the hoist cable above the harness.
- (C) A hoist cable having a minimum diameter of 5/16 inches.
- (D) Approved head protection. (See Section 1515.)
- (9) Electrical Devices. All electrical devices used within the exploration shaft by the geotechnical specialist shall be approved for hazardous locations.
- (10) Surface Hazards. The storage and use of flammable or other dangerous materials shall be controlled at the surface to prevent them from entering the exploration shaft.

1543. COFFERDAMS

- (a) If overtopping of the cofferdam by high waters is possible, means shall be provided for controlled flooding of the work area.
- (b) Warning signs for evacuation of employees in case of emergency shall be developed and posted.
- (c) Cofferdam walkways, bridges, or ramps with at least two means of rapid exit, shall be provided with guardrails as specified in Section 1620.
- (d) Cofferdams located close to navigable shipping channels shall be protected from vessels in transit, where possible.

CT TRENCHING AND SHORING MANUAL

This page is blank.

Appendix B

Memos

APPENDIX B

Memos

Insert Memos here.

CT TRENCHING AND SHORING MANUAL

This page is blank.

Appendix C

Surcharges

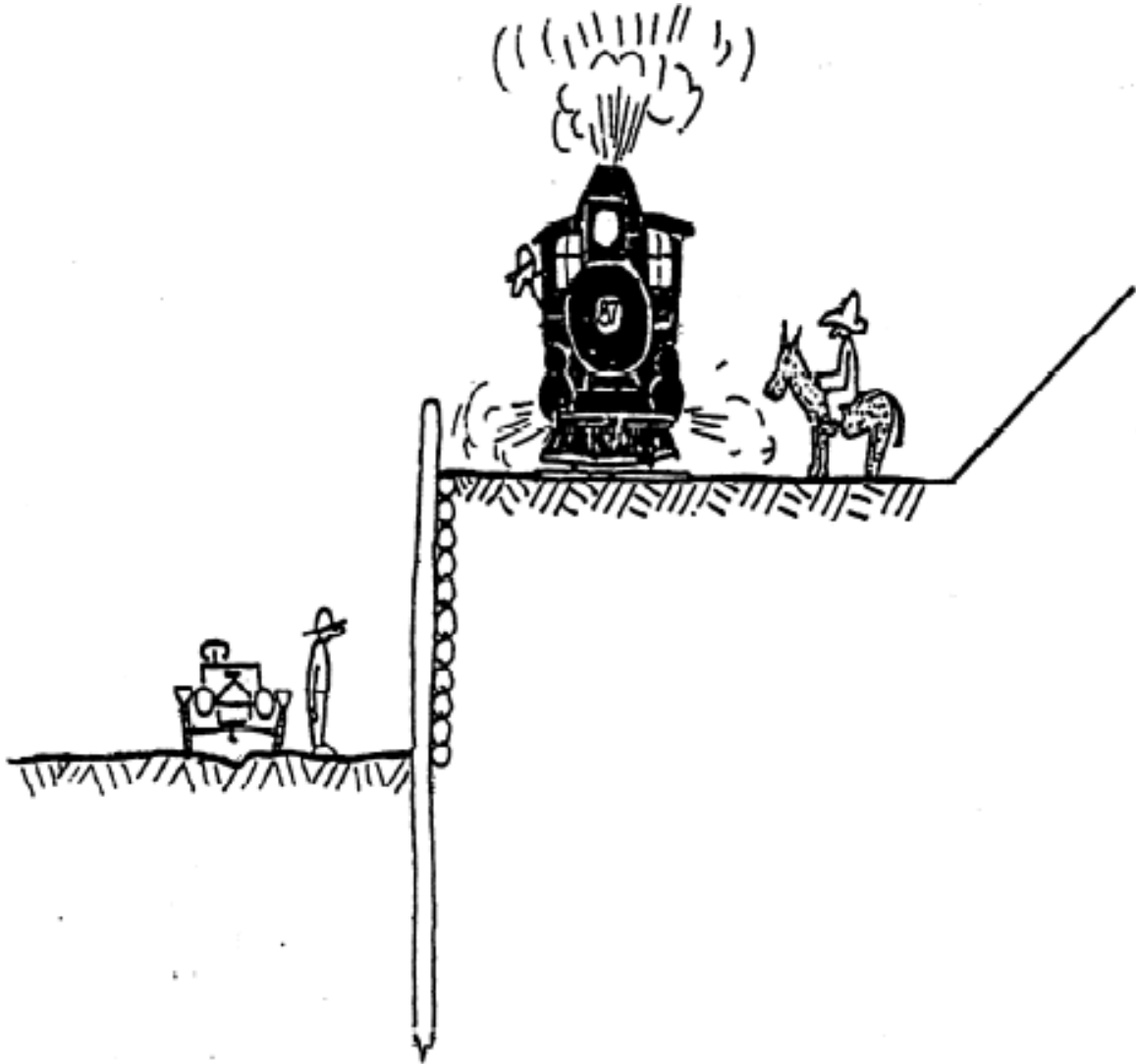

Surcharges

TABULAR VALUES FOR STRIP LOADS

The following- tabular values may be used to obtain horizontal pressures due to surcharge loadings.

Tabular values are for a Boussinesq strip surcharge of $Q = 300$ psf for a length of surcharge beginning at the face of the excavation (L_0) to the end of the strip load (L_2). Surcharge pressures are listed for one-foot increments of excavation to a depth of 20 feet.

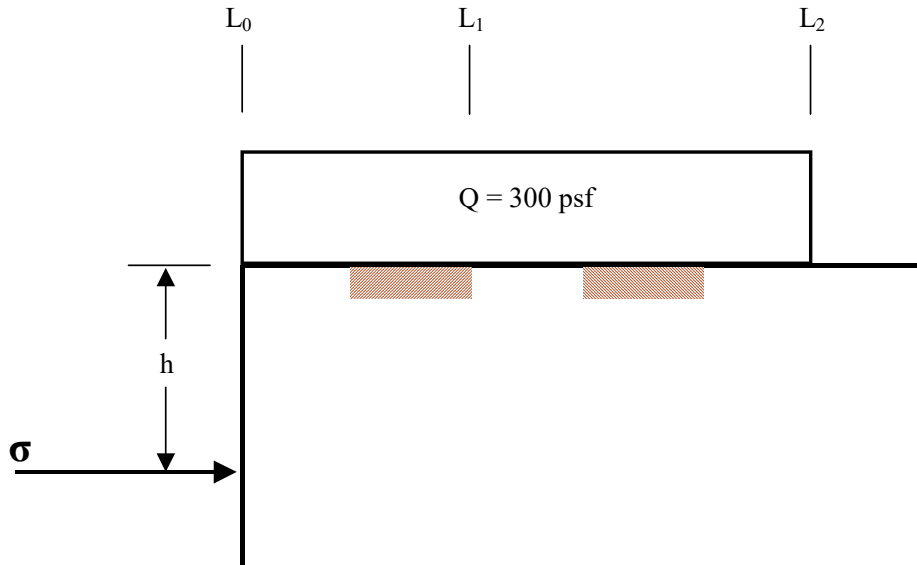

For surcharges not beginning at the face of the excavation (L_1) subtract tabular values for distance L_1 from the tabular values for L_2 . Prorate other Q values by using the ratio $Q/300$ (difference in L values).

Note: When $L_0 = 0$, the pressure at $h = 0$ is Q (300 psf).

EXAMPLE:

Begin Boussinesq strip load 6 feet from excavation, $L_1 = 6'$

End Boussinesq strip load 20 feet from excavation, $L_2 = 20'$

Surcharge load $Q = 250$ psf

Determine surcharge pressure at $h = 12'$

$$a_{12} = \frac{250}{300} (112.53 - 12.16) = 83.6 \text{ psf}$$

CT TRENCHING AND SHORING MANUAL

EXAMPLE OF ALTERNATIVE SURCHARGE AND TABULAR VALUES:

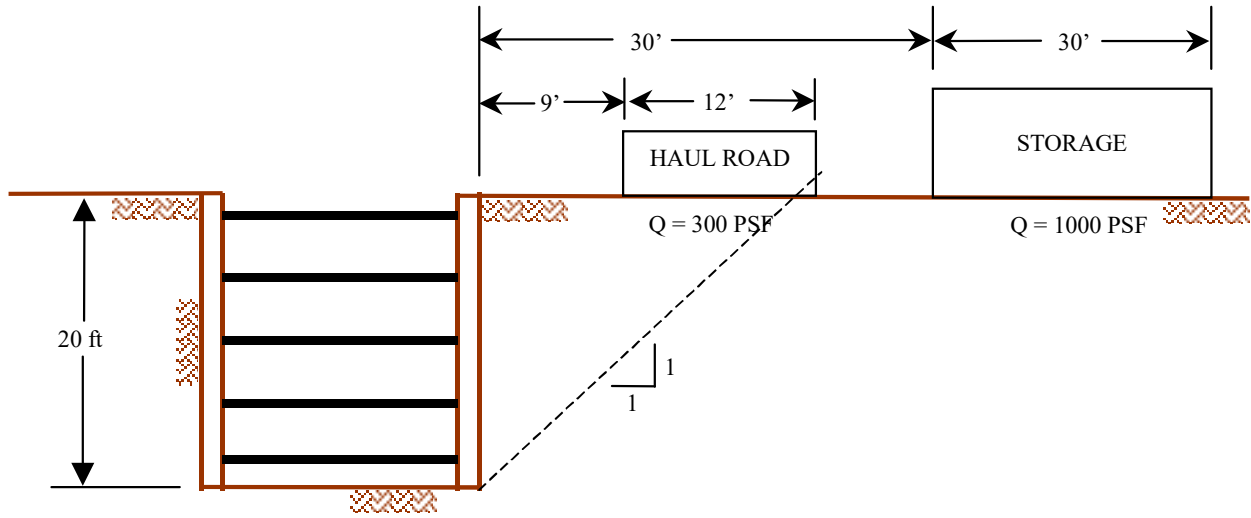

- 1) Determine surcharge pressures at 5-foot increments of depth starting at the ground surface.
- 2) Compare tabular strip load values to the alternative loading.

Sample calculations for depth = 10 feet:

$$\text{At haul road: } \sigma_{10} = 140.99 - 44.99 = 96.00 \text{ psf}$$

$$\text{For building: } \sigma_{10} = \frac{1000}{300} (237.49 - 181.25) = 187.45 \text{ psf}$$

$$\text{Building } \sigma_{10} + \text{Road } \sigma_{10} = 283.47 \text{ psf}$$

$$\text{Building } \sigma_{10} + \text{Road @ 100 psf} = 287.47 \text{ psf}$$

COMBINE SURCHARGES:

<u>Depth</u>	<u>Building σ</u>	<u>Road σ</u>	<u>Sum of σ's</u>	<u>Building $\sigma + 100 \text{ psf}$</u>
0	0.00	0.00	72.00 min	100.00
5	102.77	90.26	193.03	202.77
10	187.47	96.00	283.47	287.47
15	244.03	72.26	316.29	344.03
20	272.33	49.99	322.32	372.33

APPENDIX C

SurchargesPRESSURE AT DEPTH h FOR UNIFORM LOADINGS FROM L_0 TO L_1 OR L_2

h	1	2	3	4	5	6	7	8
1	54.51	135.06	181.25	208.27	225.57	237.49	246.16	252.74
2	12.16	54.51	99.55	135.06	161.47	181.25	196.40	208.27
3	4.15	24.15	54.51	85.43	112.53	135.06	153.52	168.69
4	1.85	12.16	31.23	54.51	77.97	99.55	118.58	135.06
5	0.97	6.81	18.95	35.70	54.51	73.39	91.21	107.48
6	0.57	4.15	12.16	24.15	38.76	54.51	70.29	85.43
7	0.36	2.70	8.18	16.88	28.13	40.97	54.51	68.07
8	0.24	1.85	5.73	12.16	20.85	31.23	42.64	54.51
9	0.17	1.32	4.15	8.99	15.77	24.15	33.70	43.94
10	0.13	0.97	3.10	6.81	12.16	18.95	26.92	35.70
11	0.09	0.74	2.37	5.27	9.53	15.08	21.73	29.24
12	0.07	0.57	1.85	4.15	7.59	12.16	17.73	24.15
13	0.06	0.45	1.47	3.33	6.13	9.92	14.61	20.11
14	0.05	0.36	1.19	2.70	5.02	8.18	12.16	16.88
15	0.04	0.30	0.97	2.22	4.15	6.81	10.20	14.27
16	0.03	0.24	0.81	1.85	3.47	5.73	8.63	12.16
17	0.03	0.20	0.67	1.55	2.93	4.86	7.36	10.42
18	0.02	0.17	0.57	1.32	2.50	4.15	6.32	8.99
19	0.02	0.15	0.49	1.13	2.14	3.58	5.46	7.81
20	0.02	0.13	0.42	0.97	1.85	3.10	4.75	6.81

CT TRENCHING AND SHORING MANUAL

PRESSURE AT DEPTH h FOR UNIFORM LOADINGS FROM L_0 TO L_1 OR L_2

h	9	10	11	12	13	14	15	16
1	257.90	262.06	265.47	268.32	270.73	272.81	274.61	276.19
2	217.79	225.57	232.04	237.49	242.14	246.16	249.66	252.74
3	181.25	191.77	200.67	208.27	214.84	220.56	225.57	230.01
4	149.24	161.47	172.05	181.25	189.31	196.40	202.68	208.27
5	122.07	135.06	146.57	156.79	165.88	173.99	181.25	187.78
6	99.55	112.53	124.34	135.06	144.75	153.52	161.47	168.69
7	81.20	93.64	105.26	116.02	125.94	135.06	143.42	151.10
8	66.39	77.97	89.06	99.55	109.39	118.58	127.12	135.06
9	54.51	65.08	75.43	85.43	94.97	104.01	112.53	120.53
10	44.99	54.51	64.03	73.39	82.47	91.21	99.55	107.48
11	37.36	45.85	54.51	63.17	71.70	80.03	88.08	95.81
12	31.23	38.76	46.57	54.51	62.45	70.29	77.97	85.43
13	26.27	32.93	39.95	47.18	54.51	61.84	69.10	76.22
14	22.24	28.13	34.41	40.97	47.70	54.51	61.32	68.07
15	18.95	24.15	29.77	35.70	41.86	48.15	54.51	60.86
16	16.25	20.85	25.87	31.23	36.84	42.64	48.55	54.51
17	14.02	18.09	22.58	27.41	32.53	37.85	43.33	48.90
18	12.16	15.77	19.79	24.15	28.81	33.70	38.76	43.94
19	10.60	13.81	17.42	21.36	25.59	30.07	34.75	39.57
20	9.29	12.16	15.39	18.95	22.81	26.92	31.23	35.70

APPENDIX C

SurchargesPRESSURE AT DEPTH h FOR UNIFORM LOADINGS FROM L_0 TO L_1 OR L_2

h	17	18	19	20	21	22	23	24
1	277.58	278.82	279.93	280.93	281.84	282.66	283.41	284.10
2	255.47	257.90	260.09	262.06	263.84	265.47	266.95	268.32
3	233.95	237.49	240.67	243.55	246.16	248.55	250.73	252.74
4	213.28	217.79	221.87	225.57	228.95	232.04	234.87	237.49
5	193.67	199.00	203.85	208.27	212.33	216.05	219.47	222.64
6	175.26	181.25	186.74	191.77	196.40	200.67	204.62	208.27
7	158.16	164.65	170.63	176.15	181.25	185.98	190.38	194.46
8	142.42	149.24	155.58	161.47	166.95	172.05	176.81	181.25
9	128.03	135.06	141.62	147.77	153.52	158.91	163.95	168.69
10	114.98	122.07	128.76	135.06	140.99	146.57	151.84	156.79
11	103.21	110.26	116.96	123.32	129.35	135.06	140.46	145.58
12	92.63	99.55	106.19	112.53	118.58	124.34	129.83	135.06
13	83.16	89.89	96.39	102.65	108.66	114.42	119.94	125.21
14	74.70	81.20	87.51	93.64	99.55	105.26	110.75	116.02
15	67.17	73.39	79.48	85.43	91.21	96.82	102.24	107.48
16	60.47	66.39	72.23	77.97	83.59	89.06	94.39	99.55
17	54.51	60.12	65.69	71.21	76.63	81.95	87.15	92.21
18	49.21	54.51	59.81	65.08	70.29	75.43	80.48	85.43
19	44.50	49.49	54.51	59.53	64.52	69.47	74.36	79.16
20	40.30	44.99	49.74	54.51	59.28	64.03	68.74	73.39

CT TRENCHING AND SHORING MANUAL

PRESSURE AT DEPTH h FOR UNIFORM LOADINGS FROM L_0 TO L_1 OR L_2

h	25	26	27	28	29	30	31	32
1	284.74	285.32	285.87	286.37	286.84	287.28	287.69	288.07
2	269.57	270.73	271.81	272.81	273.74	274.61	275.43	276.19
3	254.60	256.31	257.90	259.38	260.77	262.06	263.26	264.40
4	239.90	242.14	244.22	246.16	247.97	249.66	251.25	252.74
5	225.57	228.30	230.83	233.20	235.41	237.49	239.44	241.27
6	211.67	214.84	217.79	220.56	223.14	225.57	227.86	230.01
7	198.27	201.83	205.16	208.27	211.20	213.96	216.55	219.00
8	185.41	189.31	192.96	196.40	199.63	202.68	205.56	208.27
9	173.14	177.32	181.25	184.96	188.46	191.77	194.90	197.86
10	161.47	165.88	170.05	173.99	177.72	181.25	184.60	187.78
11	150.43	155.03	159.38	163.51	167.43	171.15	174.69	178.05
12	140.02	144.75	149.24	153.52	157.59	161.47	165.17	168.69
13	130.24	135.06	139.65	144.04	148.23	152.23	156.05	159.71
14	121.08	125.94	130.60	135.06	139.33	143.42	147.34	151.10
15	112.53	117.39	122.07	126.57	130.90	135.06	139.05	142.89
16	104.56	109.39	114.07	118.58	122.93	127.12	131.16	135.06
17	97.14	101.93	106.57	111.06	115.41	119.62	123.68	127.61
18	90.26	94.97	99.55	104.01	108.33	112.53	116.59	120.53
19	83.88	88.49	93.00	97.40	101.68	105.85	109.89	113.83
20	77.97	82.47	86.89	91.21	95.43	99.55	103.57	107.48

APPENDIX C

SurchargesPRESSURE AT DEPTH h FOR UNIFORM LOADINGS FROM L_0 TO L_1 OR L_2

h	33	34	35	36	37	38	39	40
1	288.43	288.77	289.09	289.40	289.68	289.95	290.21	290.45
2	276.91	277.58	278.22	278.82	279.39	279.93	280.45	280.93
3	265.47	266.47	267.42	268.32	269.16	269.97	270.73	271.46
4	254.15	255.47	256.72	257.90	259.02	260.09	261.10	262.06
5	242.99	244.62	246.16	247.62	249.00	250.31	251.56	252.74
6	232.04	233.95	235.77	237.49	239.12	240.67	242.14	243.55
7	221.31	223.50	225.57	227.54	229.41	231.18	232.87	234.48
8	210.85	213.28	215.60	217.79	219.88	221.87	223.76	225.57
9	200.67	203.33	205.87	208.27	210.57	212.75	214.84	216.83
10	190.80	193.67	196.40	199.00	201.48	203.85	206.11	208.27
11	181.25	184.31	187.21	189.99	192.64	195.17	197.60	199.92
12	172.05	175.26	178.32	181.25	184.06	186.74	189.31	191.77
13	163.20	166.54	169.74	172.80	175.74	178.55	181.25	183.85
14	154.71	158.16	161.47	164.65	167.70	170.63	173.44	176.15
15	146.57	150.12	153.52	156.79	159.94	162.97	165.88	168.69
16	138.80	142.42	145.89	149.24	152.47	155.58	158.58	161.47
17	131.40	135.06	138.59	142.00	145.29	148.47	151.53	154.50
18	124.34	128.03	131.60	135.06	138.39	141.62	144.75	147.77
19	117.64	121.35	124.94	128.42	131.79	135.06	138.22	141.29
20	111.28	114.98	118.58	122.07	125.46	128.76	131.95	135.06

CT TRENCHING AND SHORING MANUAL

PRESSURE AT DEPTH h FOR UNIFORM LOADINGS FROM L_0 TO L_1 OR L_2

h	41	42	43	44	45	46	47	48
1	290.69	290.91	291.12	291.32	291.51	291.70	291.88	292.04
2	281.40	281.84	282.26	282.66	283.05	283.41	283.77	284.10
3	272.15	272.81	273.44	274.04	274.61	275.16	275.69	276.19
4	262.97	263.84	264.67	265.47	266.22	266.95	267.65	268.32
5	253.87	254.95	255.98	256.96	257.90	258.81	259.67	260.50
6	244.88	246.16	247.38	248.55	249.66	250.73	251.76	252.74
7	236.02	237.49	238.89	240.23	241.52	242.75	243.94	245.07
8	227.30	228.95	230.53	232.04	233.49	234.87	236.21	237.49
9	218.73	220.56	222.30	223.97	225.57	227.11	228.59	230.01
10	210.34	212.33	214.22	216.05	217.79	219.47	221.09	222.64
11	202.14	204.27	206.31	208.27	210.16	211.97	213.71	215.39
12	194.13	196.40	198.58	200.67	202.68	204.62	206.48	208.27
13	186.33	188.73	191.02	193.24	195.36	197.42	199.39	201.30
14	178.75	181.25	183.66	185.98	188.22	190.38	192.46	194.46
15	171.39	173.99	176.50	178.92	181.25	183.51	185.68	187.78
16	164.26	166.95	169.55	172.05	174.47	176.81	179.07	181.25
17	157.36	160.12	162.80	165.38	167.88	170.29	172.63	174.89
18	150.69	153.52	156.26	158.91	161.47	163.95	166.36	168.69
19	144.26	147.14	149.93	152.64	155.26	157.80	160.27	162.66
20	138.07	140.99	143.82	146.57	149.24	151.84	154.35	156.79

APPENDIX C

SurchargesPRESSURE AT DEPTH h FOR UNIFORM LOADINGS FROM L_0 TO L_1 OR L_2

h	49	50	51	52	53	54	55	56
1	292.21	292.36	292.51	292.66	292.79	292.93	293.06	293.18
2	284.43	284.74	285.04	285.32	285.60	285.87	286.12	286.37
3	276.67	277.14	277.58	278.01	278.43	278.82	279.21	279.58
4	268.96	269.57	270.16	270.73	271.28	271.81	272.32	272.81
5	261.29	262.06	262.79	263.50	264.18	264.83	265.47	266.08
6	253.69	254.60	255.47	256.31	257.12	257.90	258.66	259.38
7	246.16	247.21	248.22	249.19	250.13	251.03	251.90	252.74
8	238.72	239.90	241.04	242.14	243.20	244.22	245.21	246.16
9	231.37	232.69	233.95	235.18	236.35	237.49	238.59	239.64
10	224.13	225.57	226.96	228.30	229.59	230.83	232.04	233.20
11	217.01	218.56	220.07	221.52	222.91	224.27	225.57	226.84
12	210.01	211.67	213.28	214.84	216.34	217.79	219.20	220.56
13	203.13	204.91	206.62	208.27	209.87	211.42	212.92	214.37
14	196.40	198.27	200.08	201.83	203.52	205.16	206.74	208.27
15	189.81	191.77	193.67	195.50	197.28	199.00	200.67	202.28
16	183.37	185.41	187.39	189.31	191.17	192.96	194.71	196.40
17	177.08	179.20	181.25	183.25	185.18	187.05	188.86	190.63
18	170.95	173.14	175.26	177.32	179.32	181.25	183.14	184.96
19	164.98	167.23	169.41	171.53	173.59	175.59	177.53	179.42
20	159.17	161.47	163.71	165.88	168.00	170.05	172.05	173.99

CT TRENCHING AND SHORING MANUAL

PRESSURE AT DEPTH h FOR UNIFORM LOADINGS FROM L_0 TO L_1 OR L_2

h	57	58	59	60	61	62	63	64
1	293.30	293.42	293.53	293.64	293.74	293.84	293.94	294.03
2	286.61	286.84	287.06	287.28	287.49	287.69	287.88	288.07
3	279.93	280.28	280.61	280.93	281.24	281.55	281.84	282.12
4	273.28	273.74	274.18	274.61	275.02	275.43	275.81	276.19
5	266.66	267.23	267.78	268.32	268.83	269.33	269.81	270.28
6	260.09	260.77	261.42	262.06	262.67	263.26	263.84	264.40
7	253.56	254.34	255.10	255.84	256.55	257.24	257.90	258.55
8	247.08	247.97	248.83	249.66	250.47	251.25	252.01	252.74
9	240.67	241.66	242.62	243.55	244.45	245.32	246.16	246.98
10	234.33	235.41	236.47	237.49	238.48	239.44	240.37	241.27
11	228.06	229.24	230.39	231.50	232.57	233.61	234.63	235.61
12	221.87	223.14	224.38	225.57	226.73	227.86	228.95	230.01
13	215.77	217.13	218.45	219.72	220.96	222.17	223.34	224.47
14	209.76	211.20	212.60	213.96	215.27	216.55	217.79	219.00
15	203.85	205.37	206.84	208.27	209.66	211.01	212.33	213.60
16	198.04	199.63	201.18	202.68	204.14	205.56	206.93	208.27
17	192.34	194.00	195.61	197.18	198.70	200.18	201.63	203.03
18	186.74	188.46	190.14	191.77	193.36	194.90	196.40	197.86
19	181.25	183.04	184.77	186.46	188.11	189.70	191.26	192.78
20	175.88	177.72	179.51	181.25	182.95	184.60	186.21	187.78

APPENDIX C

SurchargesPRESSURE AT DEPTH h FOR UNIFORM LOADINGS FROM L_0 TO L_1 OR L_2

h	65	66	67	68	69	70	71	72
1	294.12	294.21	294.30	294.38	294.47	294.54	294.62	294.70
2	288.25	288.43	288.60	288.77	288.93	289.09	289.25	289.40
3	282.40	282.66	282.92	283.17	283.41	283.65	283.88	284.10
4	276.55	276.91	277.25	277.58	277.91	278.22	278.53	278.82
5	270.73	271.17	271.60	272.01	272.42	272.81	273.19	273.56
6	264.94	265.47	265.98	266.47	266.95	267.42	267.87	268.32
7	259.18	259.79	260.38	260.95	261.51	262.06	262.58	263.10
8	253.46	254.15	254.82	255.47	256.11	256.72	257.32	257.90
9	247.78	248.55	249.30	250.03	250.73	251.42	252.09	252.74
10	242.14	242.99	243.82	244.62	245.40	246.16	246.90	247.62
11	236.56	237.49	238.39	239.26	240.11	240.94	241.75	242.53
12	231.04	232.04	233.01	233.95	234.87	235.77	236.64	237.49
13	225.57	226.64	227.69	228.70	229.68	230.64	231.58	232.49
14	220.17	221.31	222.42	223.50	224.55	225.57	226.57	227.54
15	214.84	216.05	217.22	218.36	219.47	220.56	221.61	222.64
16	209.58	210.85	212.08	213.28	214.46	215.60	216.71	217.79
17	204.39	205.72	207.01	208.27	209.50	210.70	211.87	213.00
18	199.28	200.67	202.02	203.33	204.62	205.87	207.09	208.27
19	194.25	195.69	197.10	198.46	199.80	201.10	202.37	203.61
20	189.31	190.80	192.25	193.67	195.05	196.40	197.72	199.00

CT TRENCHING AND SHORING MANUAL

PRESSURE AT DEPTH h FOR UNIFORM LOADINGS FROM L_0 TO L_1 OR L_2

h	73	74	75	76	77	78	79	80
1	294.77	294.84	294.91	294.97	295.04	295.10	295.17	295.23
2	289.54	289.68	289.82	289.95	290.08	290.21	290.33	290.45
3	284.32	284.53	284.74	284.94	285.13	285.32	285.51	285.69
4	279.11	279.39	279.67	279.93	280.19	280.45	280.69	280.93
5	273.92	274.27	274.61	274.94	275.27	275.58	275.89	276.19
6	268.75	269.16	269.57	269.97	270.36	270.73	271.10	271.46
7	263.60	264.08	264.55	265.02	265.47	265.90	266.33	266.75
8	258.47	259.02	259.56	260.09	260.60	261.10	261.58	262.06
9	253.38	254.00	254.60	255.18	255.76	256.31	256.86	257.39
10	248.32	249.00	249.66	250.31	250.94	251.56	252.16	252.74
11	243.30	244.04	244.77	245.47	246.16	246.83	247.49	248.13
12	238.31	239.12	239.90	240.67	241.42	242.14	242.85	243.55
13	233.38	234.24	235.08	235.90	236.71	237.49	238.25	239.00
14	228.48	229.41	230.30	231.18	232.04	232.87	233.69	234.48
15	223.64	224.62	225.57	226.50	227.41	228.30	229.16	230.01
16	218.85	219.88	220.89	221.87	222.83	223.76	224.68	225.57
17	214.11	215.20	216.25	217.29	218.29	219.28	220.24	221.18
18	209.44	210.57	211.67	212.75	213.81	214.84	215.85	216.83
19	204.82	206.00	207.15	208.27	209.38	210.45	211.50	212.53
20	200.26	201.48	202.68	203.85	204.99	206.11	207.21	208.27

Surcharges

This page is blank.

Appendix D

Sheet Piles

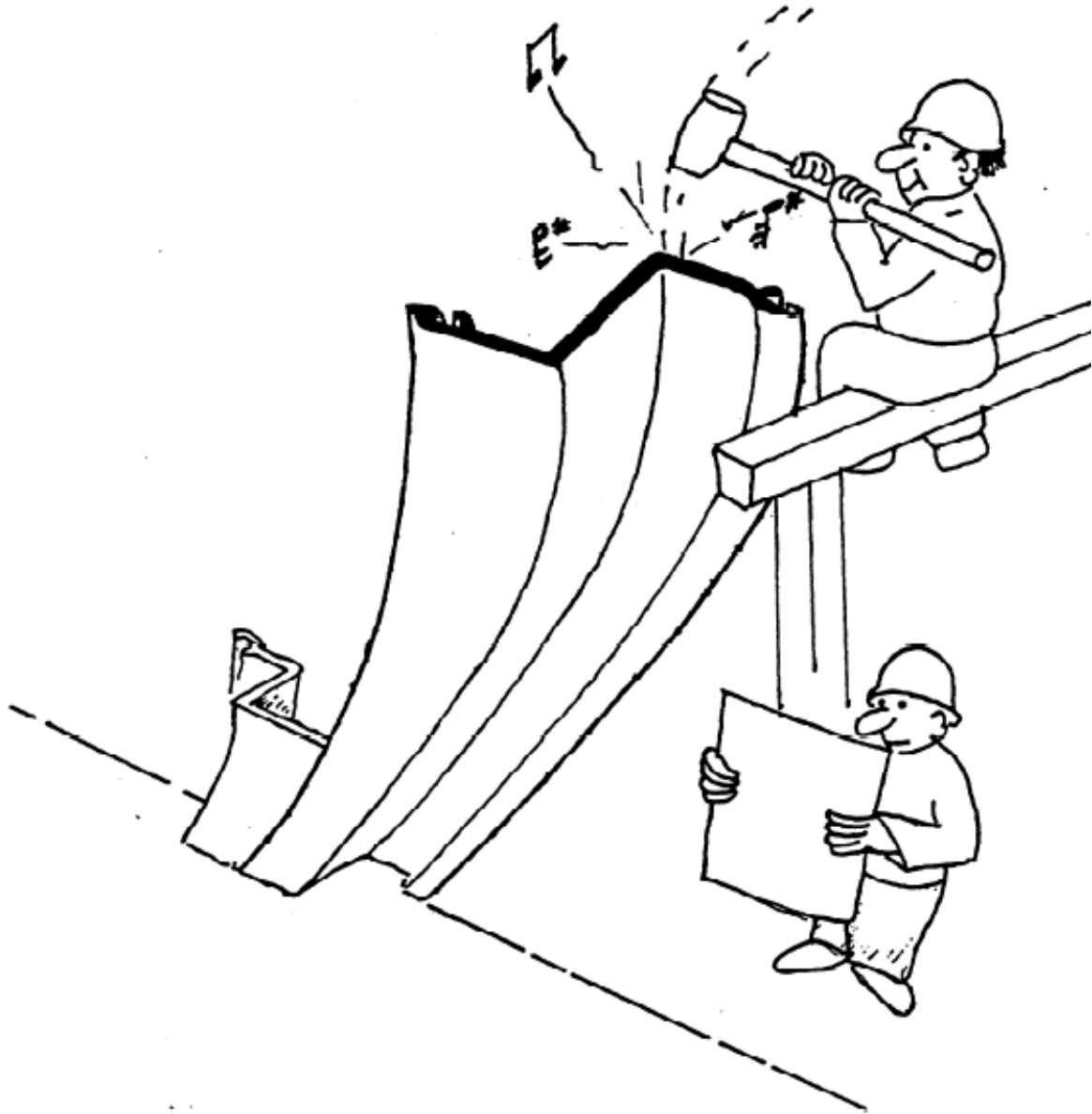

Sheet Piles

Steel Sheet Piling Products

Steel sheet piling is a manufactured construction product with a mechanical connection "interlock" at both ends of the section. These mechanical connections interlock with one another to form a continuous wall of sheet piling. Steel sheet pile applications are typically designed to create a rigid barrier for earth and water, while resisting the lateral pressures of those bending forces. The shape or geometry of a section lends to the structural strength. In addition, the soil in which the section is driven has numerous mechanical properties that can affect the performance.

Steel sheet piling is classified in two construction applications, permanent and temporary. A permanent application is "stay-in-place" where the sheet piling wall is driven and remains in the ground. A temporary application provides access and safety for construction in a confined area. Once the work is completed, the sheet piling is removed.

Z Sheet Pile

Z sections are considered one of the most efficient piles available today. Having the interlocks located at the outer fibers of the wall, assures the designer of their published section modulus.

Z-Piles are commonly used for Cantilevered, Tied-Back, King Pile and Combi-Wall retaining systems. Additional applications also include load bearing bridge abutments.

CT TRENCHING AND SHORING MANUAL

This page left blank.

Appendix E

Examples

Examples

Insert Example pages here

CT TRENCHING AND SHORING MANUAL

This page left blank.

Appendix F

Brochures

Brochures

Insert brochure pages here.

CT TRENCHING AND SHORING MANUAL

This page left blank

Appendix G

Notes & FAQ's

APPENDIX G

Notes &FAQ's

Insert Notes & FAQ Pages here.

CT TRENCHING AND SHORING MANUAL

This page left blank